



30in TurfMaster HDX Walk-Behind Lawn Mower

Tondeuse autotractée TurfMaster™ de 76 cm (30 pouces)

Quick Start Guide/Guide de Démarrage Rapide

*

<p>Register your product. Enregistrer votre produit.</p>	<p style="text-align: center;">⚠ WARNING</p> <p style="text-align: center;">CALIFORNIA Proposition 65 Warning</p> <p>The engine exhaust from this product contains chemicals known to the State of California to cause cancer, birth defects, or other reproductive harm.</p> <p>Use of this product may cause exposure to chemicals known to the State of California to cause cancer, birth defects, or other reproductive harm.</p>
---	--

For the *Operator's Manual*, the complete warranty details,** or to register your product, use the QR code or visit www.Toro.com.
 Pour vous procurer le Manuel de l'utilisateur, des détails complets sur la garantie** ou pour enregistrer votre produit, utilisez le code QR ou rendez-vous sur www.Toro.com.

 Safety alert; warning Alerte de sécurité; avertissement	 Read the <i>Operator's Manual</i> . Lisez le <i>Manuel de l'utilisateur</i> .	 Keep hands away. N'approchez pas les mains.	 Pick up any debris before mowing. Ramassez les débris éventuellement présents avant de tondre.	 Wear hearing protection. Portez des protecteurs d'oreilles.
 Look behind you when backing up. Regardez derrière la machine avant de faire marche arrière.	 Fire hazard Risque d'incendie	 Toxic gas inhalation hazard Risque d'intoxication par inhalation de gaz	 Thrown object hazard Risque de projections d'objet	 Hot surface/burn hazard Surface brûlante/risque de brûlure
 Keep bystanders a safe distance away from the machine. Tenez tout le monde à une distance suffisante de la machine.	 Cutting/dismemberment hazard of hand or foot, mower blade Risque de coupe/mutilation des mains ou des pieds, la lame de la tondeuse	 Do not operate the machine unless you are trained. N'utilisez pas la machine à moins d'avoir les compétences nécessaires.	 Shut off the engine before leaving the operating position. Coupez le moteur avant de quitter la position d'utilisation.	 Contains lead; do not discard. Contient du plomb – ne mettez pas au rebut
 Stay away from moving parts; keep all guards and shields in place. Ne vous approchez pas des pièces mobiles ; laissez toutes les protections et tous les capots en place.	 Disconnect the spark-plug wire and read the instructions before servicing or performing maintenance.	 Do not operate the machine up and down slopes; operate the machine side to side on slopes. Ne travaillez pas dans le sens de la pente, mais transversalement.	 Do not operate the machine with the deflector up or removed; keep the deflector in place. N'utilisez pas la machine avec le déflecteur relevé ou sans le déflecteur ; laissez-le toujours en place.	 Do not operate the machine without the rear-discharge plug or bag in place; do not operate the machine without the side-discharge cover or deflector in place. N'utilisez pas la machine sans l'obturateur de l'éjecteur arrière ou le bac à herbe ; n'utilisez pas la machine sans le couvercle d'éjection latérale ou le déflecteur.

**You may also call 1-888-384-9939 (US) or 1-800-544-5364 (Canada) to request a written copy of the product warranty.
 Vous pouvez aussi appeler le 1-888-384-9939 (États-Unis) ou 1-800-544-5364 (Canada) pour demander une copie écrite de la garantie produit.



1

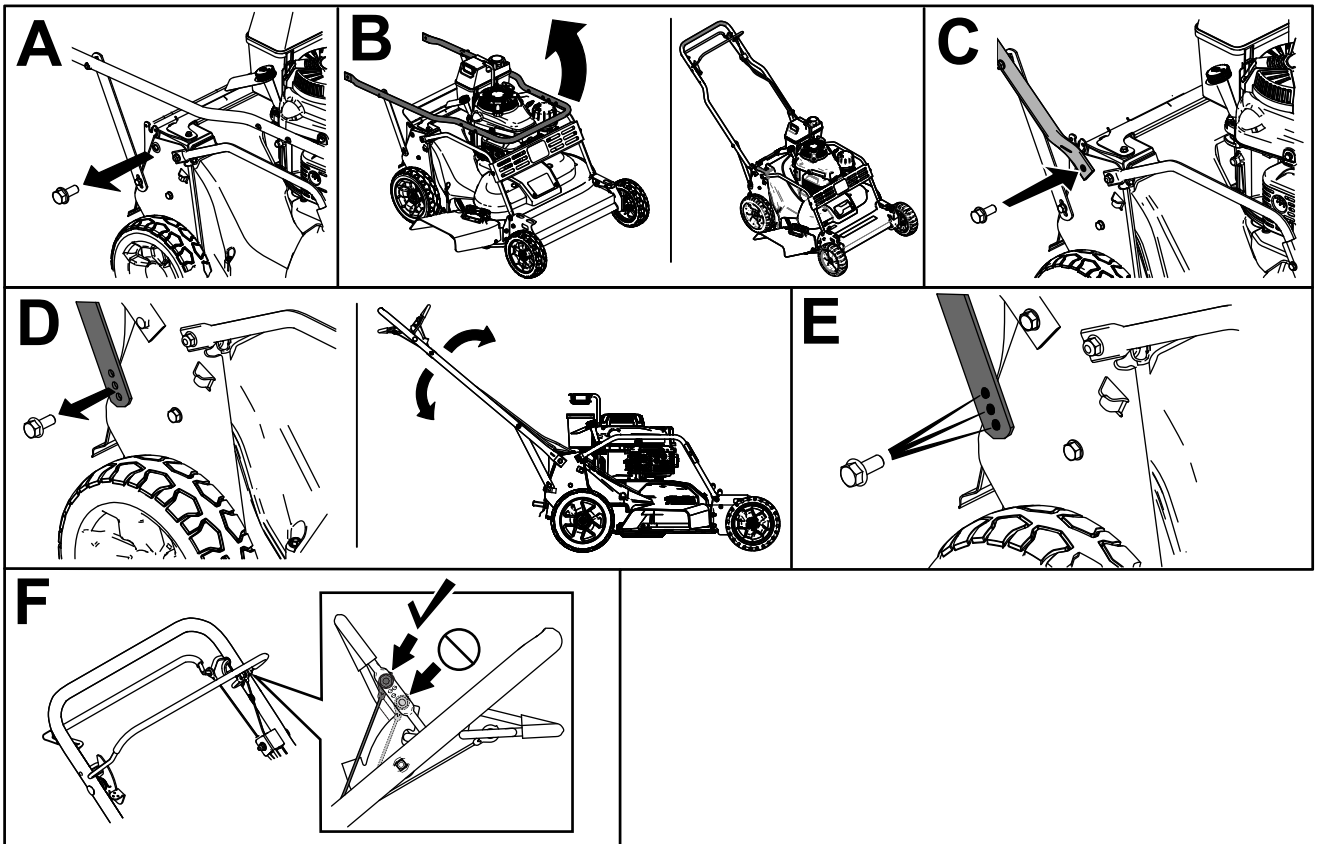

g232355

2

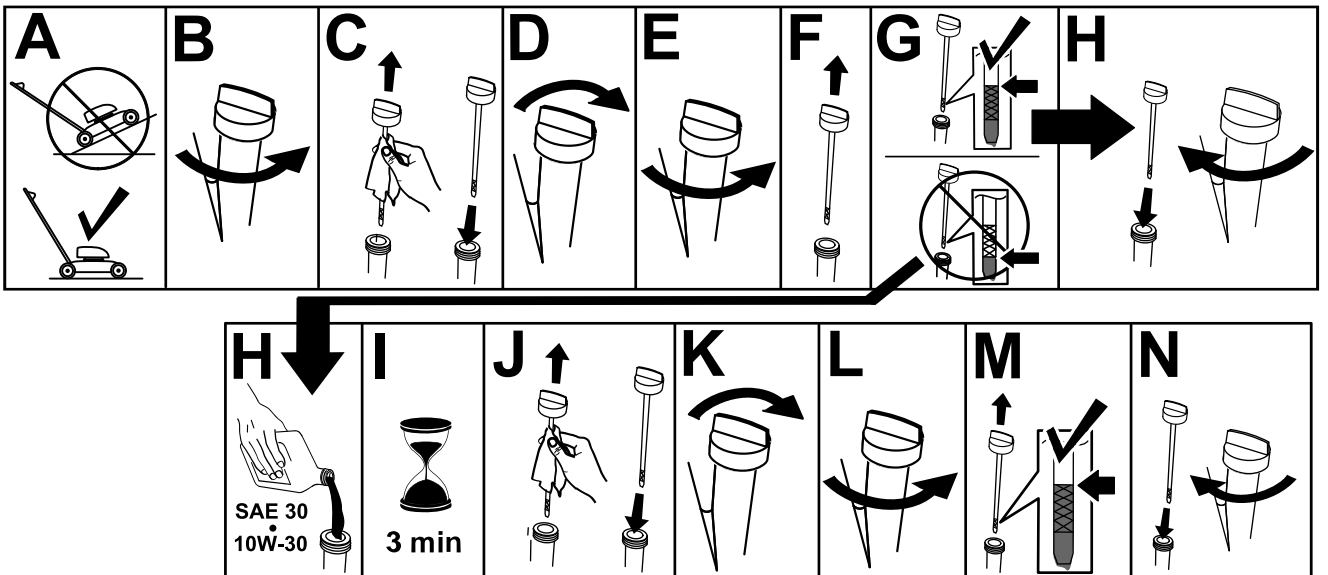

g222533

3

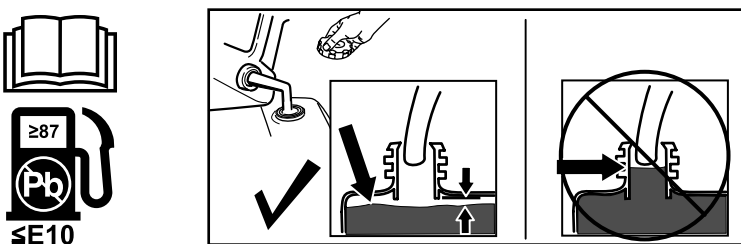

g231763

4

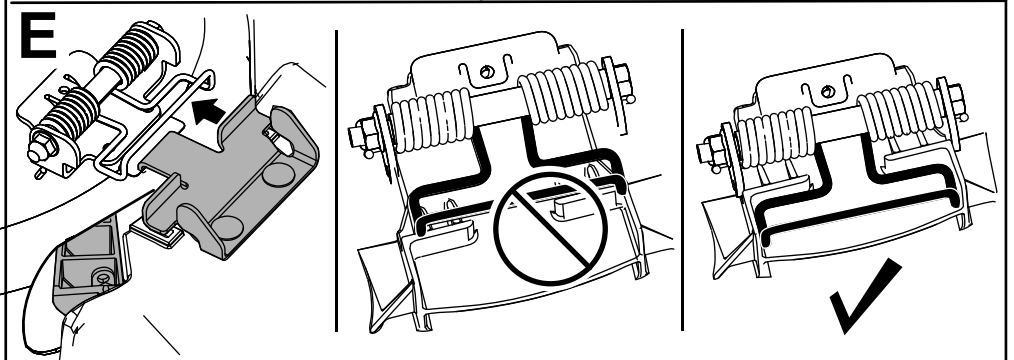
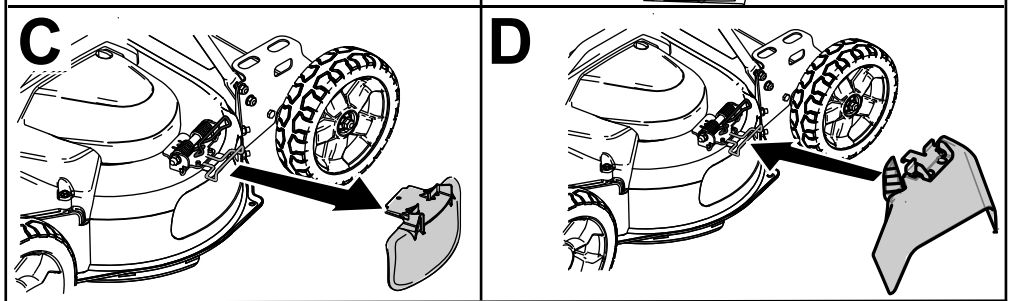
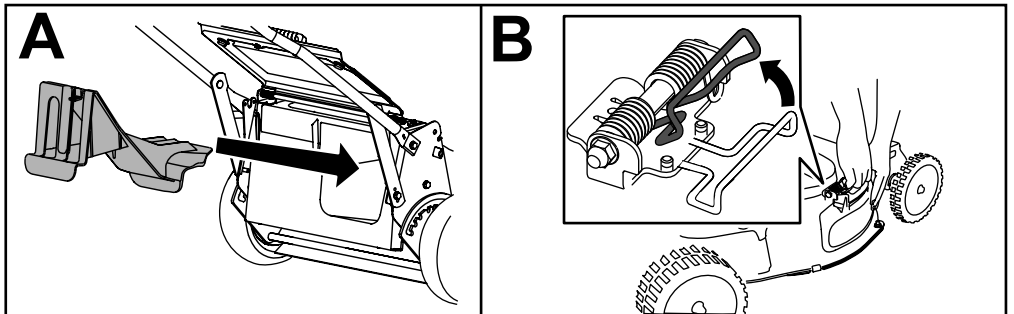
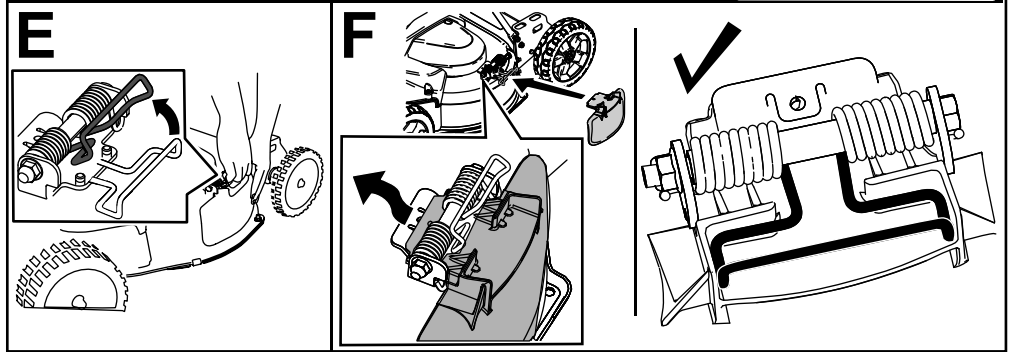
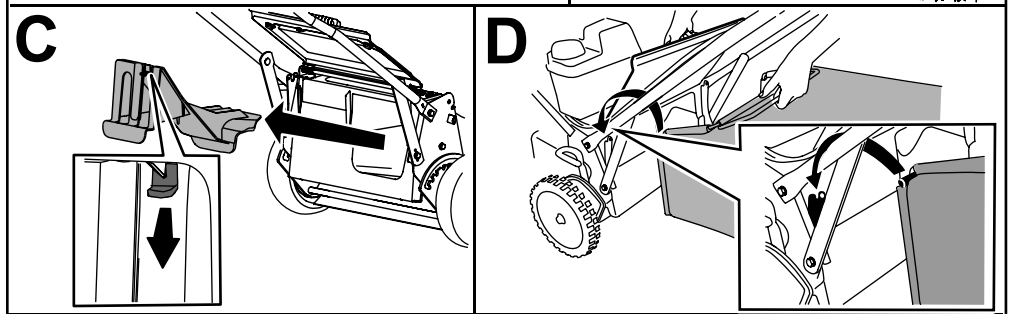
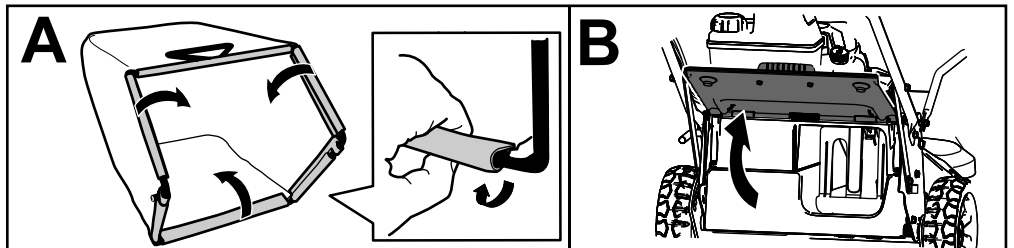
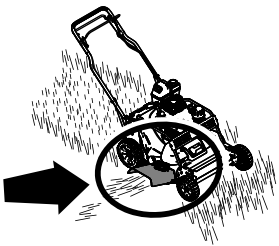
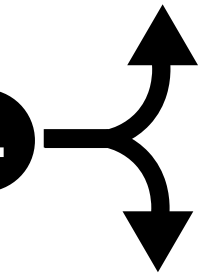
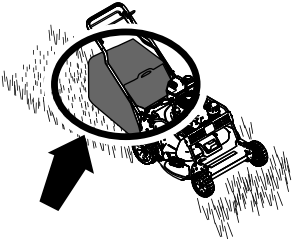

g232244

5

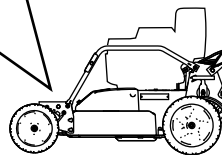
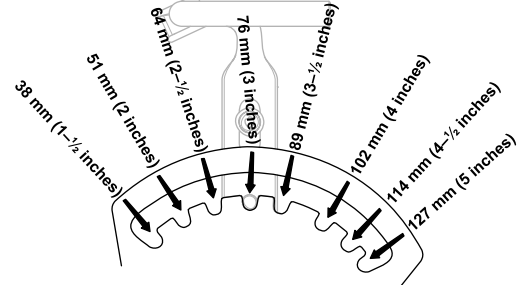
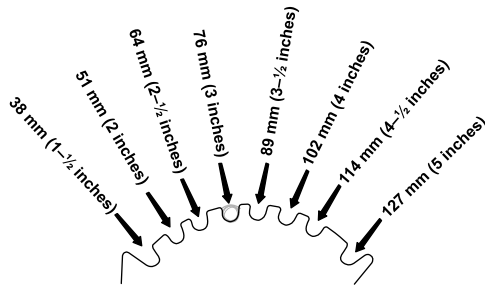
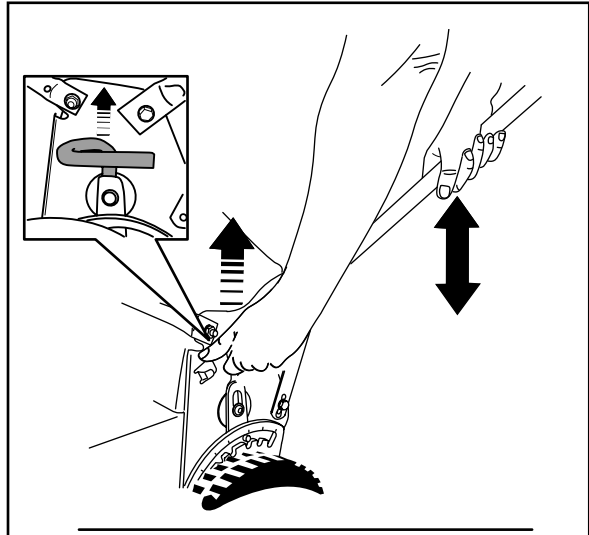
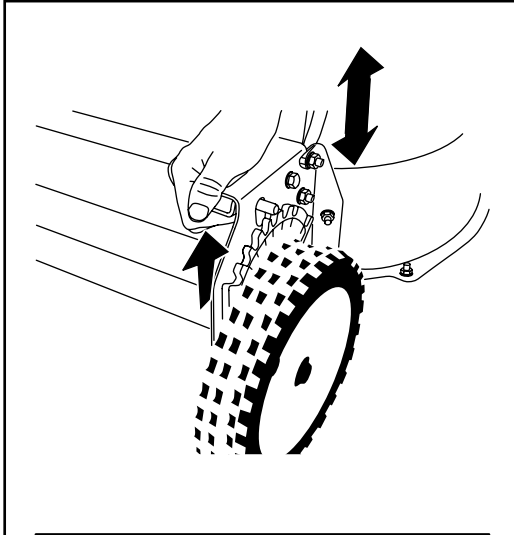
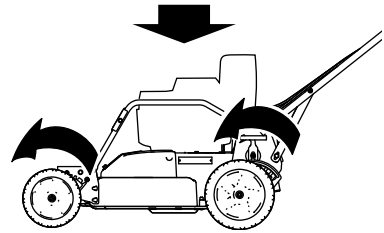
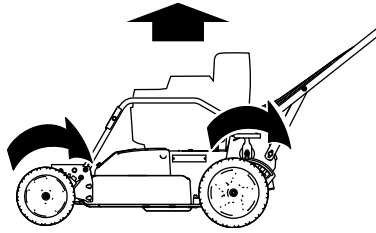

g232160

6

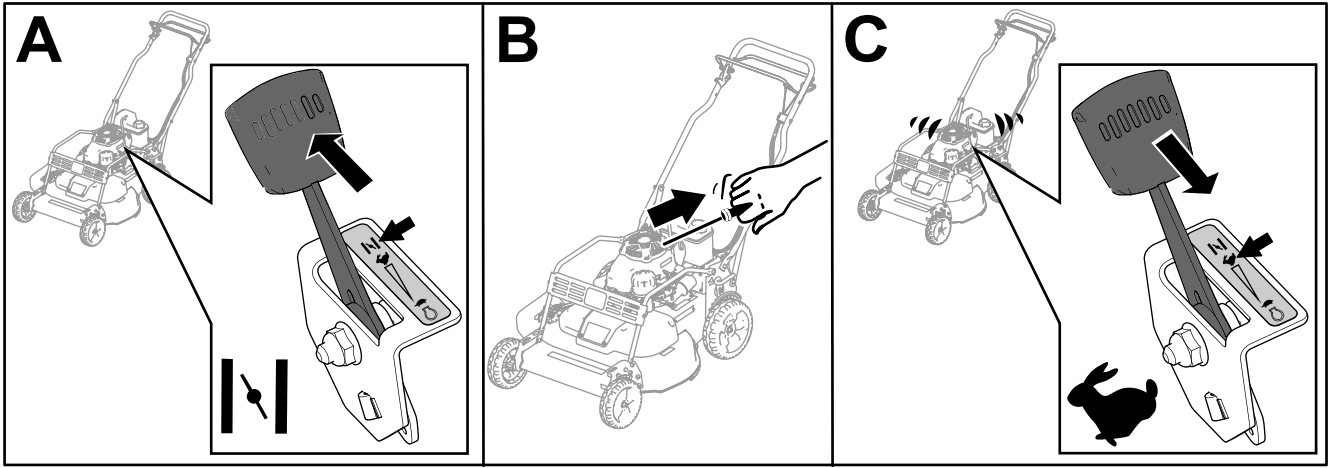

g232243

7

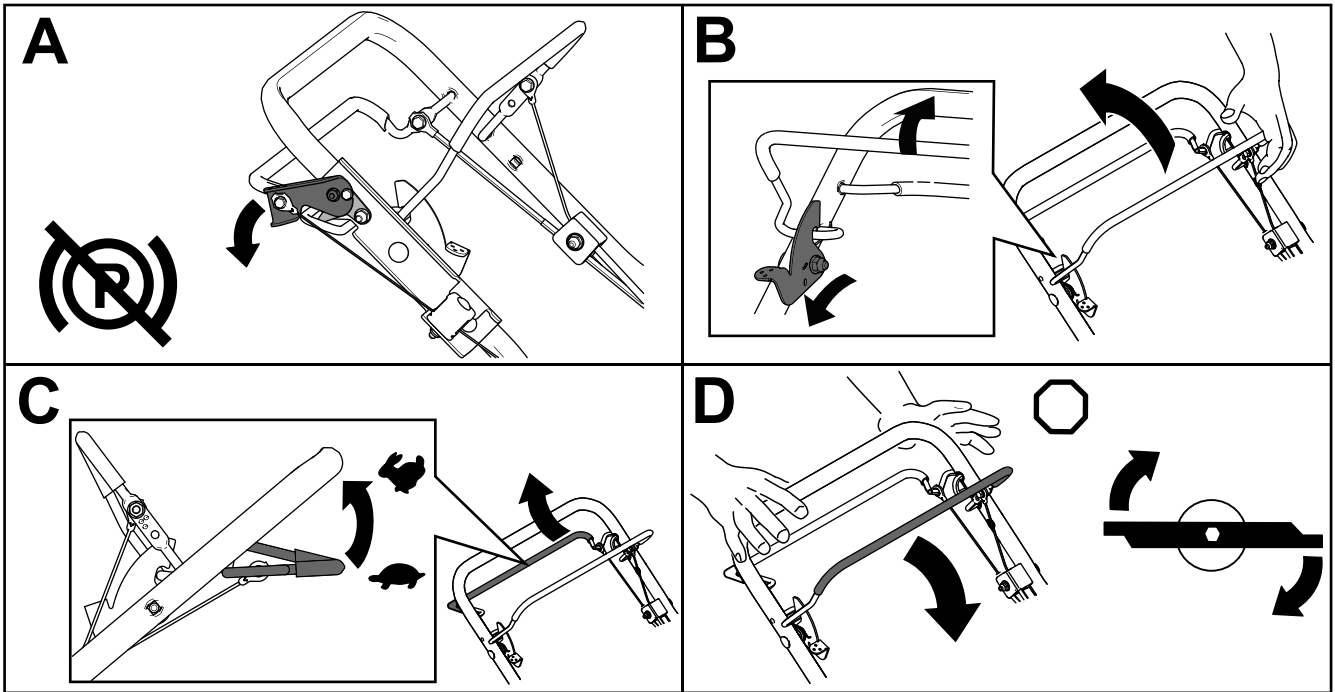

g272117

8

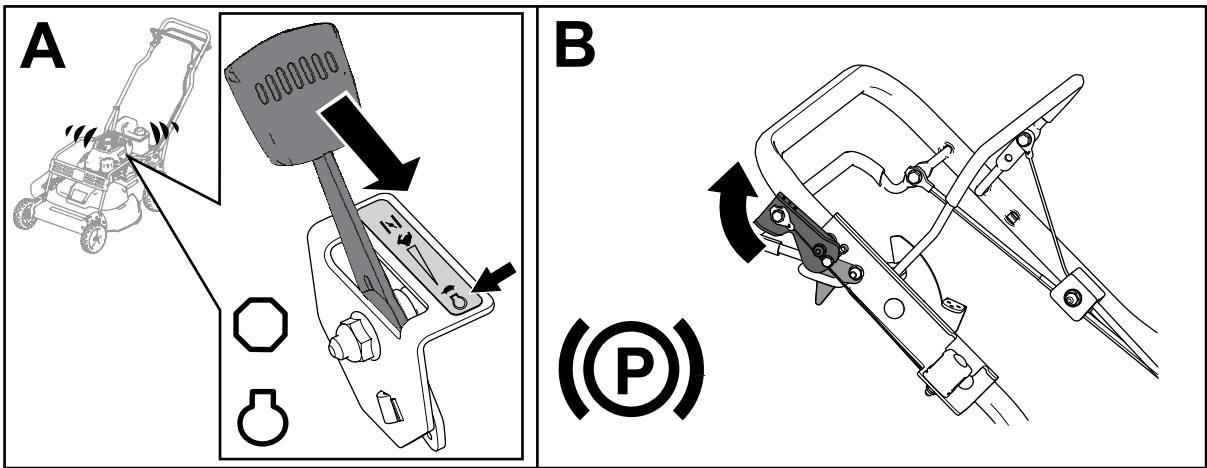

g272118



Count on it.