

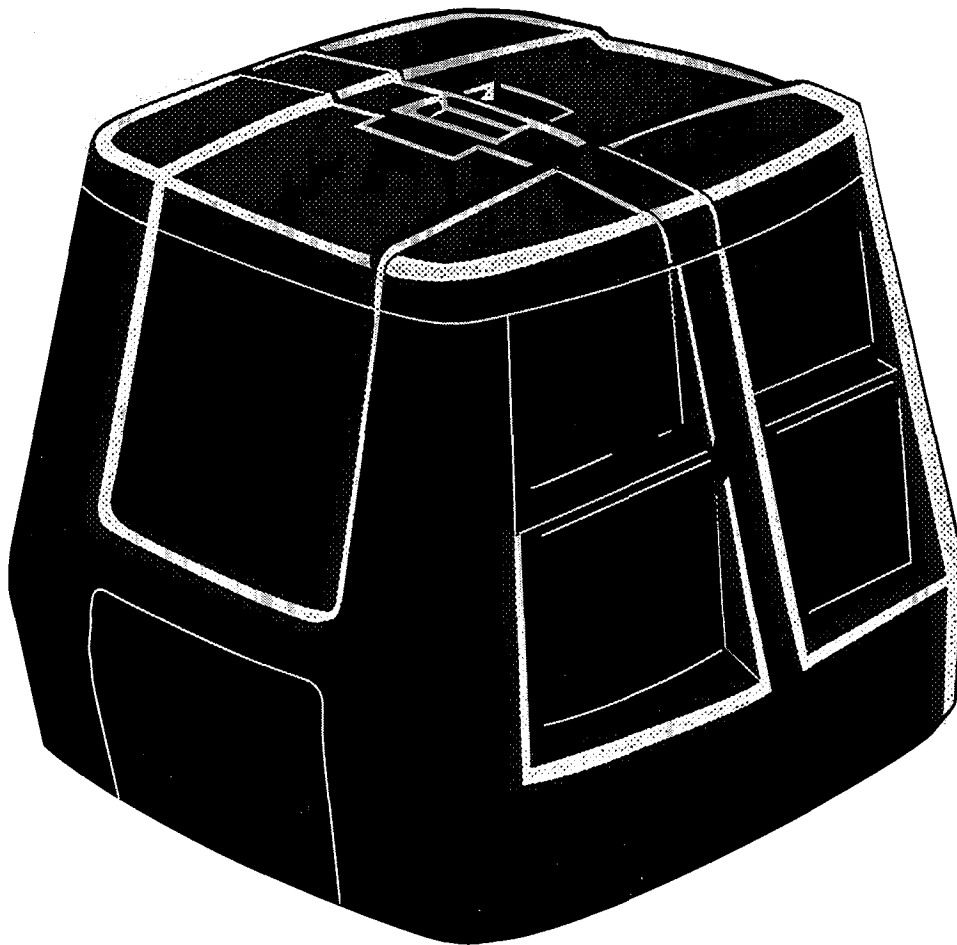

MODEL NO. 52099

**OPERATOR'S
MANUAL**

YARDCYCLER™ COMPOST SYSTEM



Congratulations on your investment in the environment. This TORO YardCycler™ is a compost system that will save you time and money, provide rich compost, and greatly reduce your yard waste problems.

Why Compost?

- Composting eliminates the need for you to haul yard refuse away.
- Composting is a simple, important contribution to preserving our environment. It can eliminate up to 20% of the volume in landfills across America.
- It saves you money. Composting the grass and leaves from a typical ¼ acre yard can provide up to \$100 of humus, fertilizers and soil conditioners. In many municipalities, it can save up to \$150 a year in hauling costs assessed for green waste.
- Compost-conditioned plants and other vegetation resist disease and insects better.
- Compost promotes a healthier garden by balancing the soil's pH, providing better drought protection, and buffering against toxins. Compost also helps control weeds, while adding valuable nutrients to the soil that synthetic fertilizers and conditioners don't have.

Site Selection and Assembly

Install the YardCycler™ on a level, well-drained area with good exposure to the sun for adequate heat. Make sure it is directly on the ground so that worms and beneficial microorganisms can enter.

Tools required: Common pliers or ½-inch box wrench or adjustable wrench.

Parts list:

- 2 Cover halves
- 2 Right-hand mixing slot sections
- 2 Left-hand mixing slot sections
- 2 Side walls
- 2 Bottom doors
- 28 Washers, bolts, lock washers, and nuts

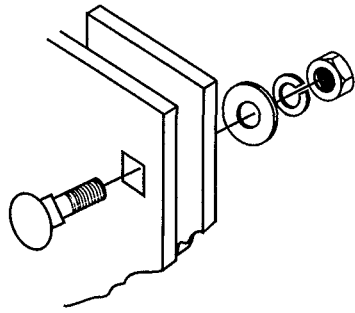

It's easy to assemble the YardCycler™—the panels just bolt together. Be sure to use both the washer and lockwasher as shown in the diagram to the left.

Step 1

Bolt the two cover halves together. These two halves overlap. The edge with the small overhang (see illustration) on each section covers the edge without the overhang on the opposite section.

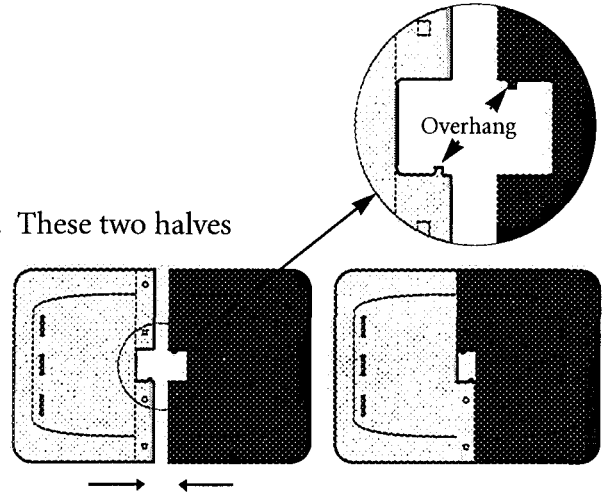

Step 2

Bolt together one right-hand (notched) and one left-hand mixing slot panel (without notches) for the first side. Repeat this for the second side.

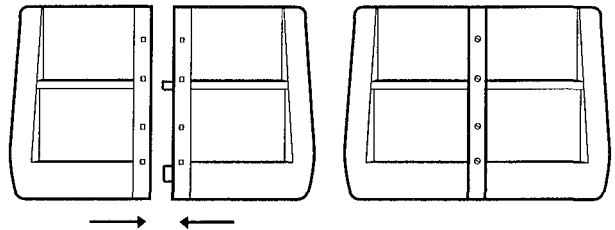

Step 3

Bolt one completed mixing slot panel with one side panel. Then repeat this for the remaining mixing slot panel and side panel.

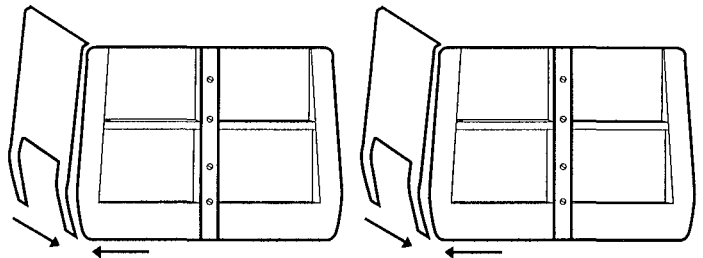

Step 4

Bolt together the two completed assemblies.

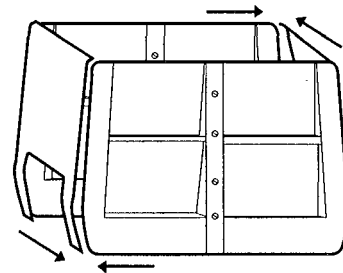

Step 5

Place the doors in the slots on the end of both side panels.

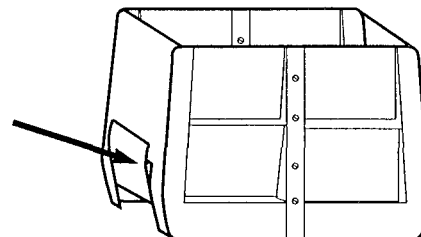

Operation

You're ready now to start eliminating your yard waste problems and begin making great compost. Composting is a matter of three simple steps:

1. Loading and mixing materials in the composter.
2. Adding moisture to bring the materials to the consistency of a wrung out sponge.
3. Turning the materials periodically.

1. Loading Materials



CAUTION!

Sawdust from treated lumber or grass or leaves treated with herbicides or pesticides can cause illness.

- Never compost or mulch with grass or leaves treated with herbicides or pesticides.
- Never use sawdust from treated wood. Treated lumber can be hazardous to you and your compost.

Keep the YardCycler™ full for best composting action.

You can compost leaves, grass clippings, potato peels, apple cores, plant trimmings, etc. Simply load up to 12.5 bushels of compostable materials into your YardCycler™. Keep the YardCycler™ as full as possible. Shredded materials work best—smaller pieces compost better. (The TORO 700 Yard Blower-Vac and 850 Superblower-Vac™ reduce leaves to a blended composition that promotes quick composting and good air flow.)

Mix different materials, don't layer. Mixing different materials speeds the composting process, especially if you blend products that are high in carbon (such as leaves and sawdust) with products that are high in nitrogen (such as grass clippings and vegetable peelings). Tables listing the carbon/nitrogen content for several common yard items are shown on page 7. Remember, composting is best when you mix leaves with grass.

If you only have leaves, add ¼ cup of TORO YardCycler™ Accelerator (available from your TORO retailer) to each 4–6 inches of shredded leaves. It speeds the natural composting process by adding natural enzymes and microorganisms to help grass and leaves break down quickly.

When you only have grass: The YardCycler™'s patented mixing slots and vents

Operation (continued)

Mix grass-only loads with TORO Accelerator or Peat Moss.

combine with its large critical size to provide an ideal climate for composting grass by itself. Grass alone, however, because it's high in nitrogen, sometimes causes odors and a gooey texture unless it's lifted and mixed often (see *Lift The Compost Every 4–7 Days*, below). To help balance the composting process and enrich the finished compost, we recommend TORO YardCycler™ Grass Formula Compost Accelerator. It aids in decomposition, odor control and fortifying finished compost with essential Vital Minerals™ and the key plant trace elements essential for plant growth. Another solution is to add peat moss to counteract the high nitrogen content of the grass.

Special Mixing Considerations:

- You can use manure from horses, cows or any plant-eating animals, but not your cat or dog. Manure is mixed best with leaves but can be added to mostly grass compost with an extra turning each week
- Don't put meats, fats or dairy products in the compost. Meat attracts rodents, it smells, and it may contain harmful bacteria. Fat also slows the compost process.

2. Add Moisture.

Water is essential for good composting. Once you have properly mixed your high-carbon and high-nitrogen products together, add water to maintain the consistency of a wrung-out sponge. Too dry a mixture stops decomposition and the heat. Too much moisture causes the pile to smell. Keeping the pile moist also discourages rodents from digging & nesting.

The TORO YardCycler™ automatically adds rain water through the cover to help maintain minimum moisture levels.

The compost process generates heat when the materials are mixed well, moisture is maintained and the compost is ventilated and turned regularly. Compost can get as hot as 180°F in the middle, which helps kill weed seeds and other unwanted products. Position the composter in the sun whenever possible to help this process even more. You may need to also add water more often when the location is warmer.

3. Lift The Compost Every 4–7 Days.

Lifting your pile every 4 to 7 days accelerates the composting process by adding oxygen and getting fresh material to the center of the composter. It also ensures more uniform decomposition. If your compost is clumped and gooey, you must turn it more often. Also, freshly cut grass is high in nitrogen and is over two-thirds water. It requires extra turning.

Use a fork with a **strong** handle and thick tines, such as a regular garden/potato fork.

Lifting is easy with TORO's YardCycler™. Simply insert a garden fork straight down into the top opening and push down on the handle to mix the material. After the top material has been loosened and turned, insert your garden fork into the lower slot and mix the thick material.

Keep adding to the composter every week. The fuller the YardCycler™ is, the better it composts. You may be able to use your compost in as little as 3 weeks (4–6 weeks is average) if you have the right mixture.



Use TORO Accelerators and turn the compost every four days or so. Turning adds air and makes the process faster with more uniform results.

Your compost is ready when no more heat is generated after turning, and it has a dark, crumbly texture with few signs of the original material left. You can completely dig out finished compost after each batch, or you can continue to add fresh material on top of the old compost. When the composter is half-full of finished compost, it should be emptied. This is usually half-way through the summer.

You can easily remove your compost through the special doors on both sides of the YardCycler™. To open them, push them in, then lift them up. (**Note:** The doors have a hole in them so they can be locked shut with a small nail if you wish.)

Using Your Compost

Some of the benefits of compost include:

- Moisture and water retention.
- Weed control
- Slow-release organic fertilizer
- Soil structure conditioner (loosens heavy clay soil and increases the water holding capacity of sandy soils.)

There are dozens of uses for good compost. Here are some of the best:

- Till it into your vegetable or flower garden one month before planting.
- Mulch between rows and plants of a vegetable garden.
- Annually, spread ½–1 inch of compost around trees and shrubs, extending

2--3 feet from tree trunks.

- Top dress your lawn when seeding.
- Liquid fertilizer. (To make compost tea: put compost into a burlap bag and soak it in water. Apply it as you would apply any liquid fertilizer.)
- Potting soil: *For indoor plants*—mix with equal parts vermiculite or perlite. *For outdoor plants*—mix with equal parts of garden soil.

Carbon/Nitrogen Ratios and Mineral Levels of Common Home and Yard Debris

The main growth ingredients for fertilizer are nitrogen, phosphorus and potassium. Composting provides all three ingredients organically, plus most key trace elements. The charts below will help you select which materials are high in nitrogen, phosphorus and potassium.

Composting works best when you blend materials that are high in carbon with materials that are high in nitrogen. The chart below shows several high-carbon materials that contribute to better composting.

HIGH CARBON	
Material	C/N ratio
Leaves	
Oak	50:1
Maple	60:1
Ash	35:1
Fruit Trees	35:1
Pine Needles	70:1
Corn Stalks	60:1
Sawdust	500:1
Shredded Newspaper	170:1
Peat Moss	

HIGH NITROGEN	
Material	C/N ratio
Grass	19–25:1
Egg Shells	25:1
Fruit Wastes	35:1
Humus	10:1
Vegetable Wastes	15:1

HIGH PHOSPHORUS	
Material	% Phosphorus
Bonemeal	21
Fish Meal	4
Phosphorus Rock (ground)	30

HIGH POTASSIUM	
Material	% Potassium
Granite dust	5
Greensand	5
Seaweed (Meal or Liquid)	5
Wood ashes	7
Vegetable Wastes	15:1

Enjoy your new YardCycler™. It accelerates the composting process and it's easy to use. Best of all, it helps the environment while saving you money!

