



Count on it.

Operator's Manual

Flex-Force Power System™ 60V MAX Battery Charger

Model No. 81802—Serial No. 319000001 and Up
Model No. 81805—Serial No. 320000001 and Up
Model No. 81825—Serial No. 319000001 and Up
Model No. 81850—Serial No. 320000001 and Up
Model No. 81860—Serial No. 319000001 and Up
Model No. 81875—Serial No. 319000001 and Up

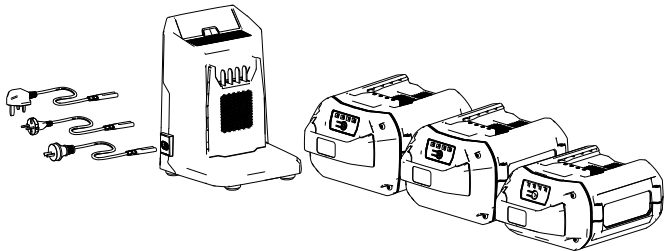

Introduction

This battery pack/charger is intended to be used by residential homeowners. Battery chargers Model 81802 and Model 81805 are designed to charge lithium-ion battery pack Models 81825, 81850, 81860, and 81875. They are not designed to charge any other batteries. Using these products for purposes other than their intended use could prove dangerous to you and bystanders.

Battery pack Models 81825, 81850, 81860, and 81875 are designed primarily for use in most Flex-Force Power System™ products.

Read this information carefully to learn how to operate and maintain your product properly and to avoid injury and product damage. You are responsible for operating the product properly and safely.

Visit www.Toro.com for more information, including safety tips, training materials, accessory information, help finding a dealer, or to register your product.

Safety

IMPORTANT SAFETY INSTRUCTIONS

1. **SAVE THESE INSTRUCTIONS**—This manual contains important safety and operating instructions for battery pack Models 81825, 81850, 81860, and 81875 and battery chargers Model 81802 and Model 81805.
2. Before using the battery charger, read all the instructions and cautionary markings on the battery charger, battery pack, and product using the battery pack.
3. **CAUTION**—To reduce risk of injury, charge battery pack Models 81825, 81850, 81860, and 81875 with battery chargers Model 81802 and Model 81805 only. Other brands of battery packs may burst, causing personal injury and damage.



4. **WARNING**—Plugging the battery charger into an outlet that is not 100 to 240 V can cause a fire or electric shock. Do not plug the battery charger into an outlet other than 100 to 240 V. For a different style of connection, use an attachment plug adapter of the proper configuration for the power outlet if needed.
5. **CAUTION**—A mistreated battery pack may present a risk of fire or chemical burn. Do not disassemble the battery pack. Do not heat the battery pack above 68°C (154°F) or incinerate it. Replace the battery pack with a genuine Toro battery pack only; using another type of battery pack may cause a fire or explosion. Keep battery packs out of the reach of children and in the original packaging until you are ready to use them.
6. These devices comply with Part 15 of the FCC rules. Operation is subject to the following 2 conditions: (1) These devices may not cause harmful interference; and (2) these devices must accept any interference received, including interference that may cause undesired operation.

I. Training

1. Do not allow people with reduced physical, sensory, or mental capabilities or without experience and knowledge to use the battery charger unless they have received instruction or supervision on using it safely and understand the hazards involved while using it.
2. Do not allow children to use or play with the battery pack or battery charger; local regulations may restrict the age of the operator.

II. Preparation

1. Use appliances only with specifically designated battery packs. Using other types of battery packs may create a risk of injury and/or fire.
2. Do not use a damaged or modified battery pack or battery charger. It may exhibit unpredictable behavior, resulting in fire, explosion, or risk of injury.
3. If the supply cord to the battery charger is damaged, contact an Authorized Service Dealer to replace it.

III. Operation

1. Do not use non-rechargeable batteries.
2. Charge the battery pack with only the battery charger specified by Toro. A charger suitable for 1 type of battery pack may create a risk of fire when used with another battery pack.
3. Charge the battery pack in a well-ventilated area only.

4. Do not expose a battery pack or battery charger to fire or to temperatures higher than 100°C (212°F).
5. Follow all charging instructions and do not charge the battery pack outside of the temperature range specified in the instructions. Otherwise, you may damage the battery pack and increase the risk of fire.
6. Under abusive conditions, the battery pack may eject liquid; avoid contact. If you accidentally come into contact with the liquid, flush with water. If the liquid contacts your eyes, seek medical help. Liquid ejected from the battery pack may cause irritation or burns.

IV. Maintenance and Storage

1. Do not allow children to clean or maintain the battery charger without supervision.
2. When the battery pack is not in use, keep it away from metal objects such as paper clips, coins, keys, nails, and screws that can make a connection from 1 terminal to another. Shorting the battery terminals may cause burns or a fire.
3. Do not attempt to repair the battery pack or battery charger. Have an Authorized Service Dealer perform service on the battery pack or battery charger using identical replacement parts to ensure that the product is safely maintained.
4. Do not dispose of the battery in a fire. The cell may explode. Check with local codes for possible special disposal instructions.

SAVE THESE INSTRUCTIONS

Safety and Instructional Decals



Safety decals and instructions are easily visible to the operator and are located near any area of potential danger. Replace any decal that is damaged or missing.



137-9496

decal137-9496

1. The battery pack is charging.
2. The battery pack is fully charged.
3. The battery pack is over or under the appropriate temperature range.
4. Battery pack charging fault

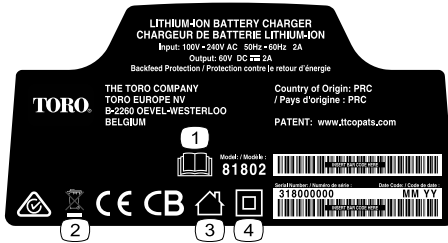

137-9495

decal137-9495

1. Read the *Operator's Manual*.
2. Do not discard.
3. For indoor use.
4. Double insulated.

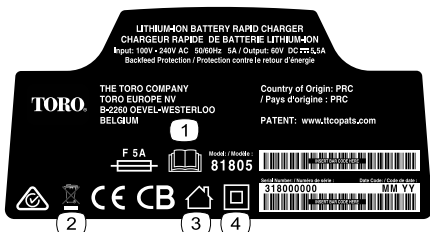

decal140-8472

140-8472

1. Read the *Operator's Manual*.
2. Do not discard.
3. Residential
4. Double insulated



decal137-9489

137-9489

1. Read the *Operator's Manual*.
2. Recycle
3. Contains lithium ions; do not discard.
4. Keep away from open flames.
5. Do not expose to rain.

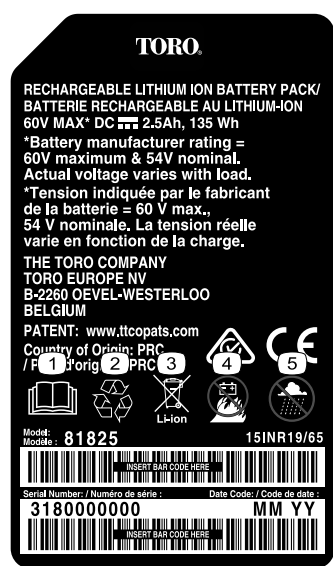

decal137-9487

137-9487

1. Read the *Operator's Manual*.
2. Recycle
3. Contains lithium ions; do not discard.
4. Keep away from open flames.
5. Do not expose to rain.





decal137-9490

137-9490

1. Read the *Operator's Manual*.
2. Recycle
3. Contains lithium ions; do not discard.
4. Keep away from open flames.
5. Do not expose to rain.

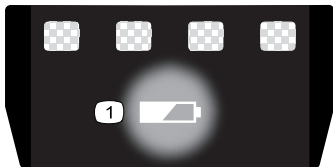

decal137-9461

137-9461

1. Battery charge status



decal140-2158

140-2158

1. Read the *Operator's Manual*.
2. Recycle the battery properly.
3. Do not discard.
4. Do not expose to flame.
5. Do not expose to rain.

Setup

Mounting the Battery Charger (Optional)

If desired, mount the battery charger securely on a wall using the wall-mount key holes on the back of the charger.

Mount it indoors (such as a garage or other dry place), near a power outlet, and out of the reach of children.

Refer to [Figure 1](#) for assistance in mounting the charger.

Slide the charger over the appropriately positioned hardware to secure the charger in place (hardware not included).

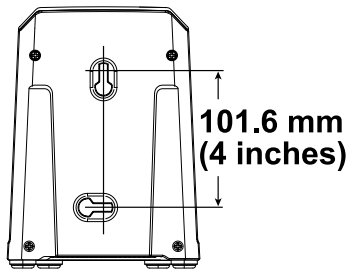

Figure 1

g290534

Product Overview

Specifications

Battery Charger

Model	81802	81805
Type	60V MAX Lithium-Ion Battery Charger	60V MAX Lithium-Ion Battery Rapid Charger
Input	100 to 240V AC 50/60Hz Max 2.0A	100 to 240V AC 50/60Hz Max 5.0A
Output	60V MAX DC 2.0A	60V MAX DC 5.5A

Battery Pack

Model	81825	81850	81860	81875
Battery pack capacity	2.5 Ah 135 Wh	4.0 Ah 216 Wh	6.0 Ah 324 Wh	7.5 Ah 405 Wh
Battery manufacturer rating = 60V maximum and 54V nominal. Actual voltage varies with load.				

Appropriate Temperature Ranges

Charge battery pack at	5°C (41°F) to 40°C (104°F)*
Use battery pack at	-30°C (-22°F) to 49°C (120°F)
Store battery pack/charger at	5°C (41°F) to 40°C (104°F)*

*Charging time will increase if you do not charge the battery within this range. Store the tool, battery pack, and battery charger in an enclosed clean, dry area.

Operation

Charging the Battery Pack

Important: The battery pack is not fully charged when you purchase it. Before using the tool for the first time, place the battery pack in the charger and charge it until the LED display indicates the battery pack is fully charged. Read all safety precautions.

Important: Charge the battery pack only in temperatures that are within the appropriate range; refer to [Specifications \(page 9\)](#).

Note: At any time, press the battery-charge-indicator button on the battery pack to display the current charge (LED indicators).

1. Ensure that the vents on the battery and charger are clear of any dust and debris.

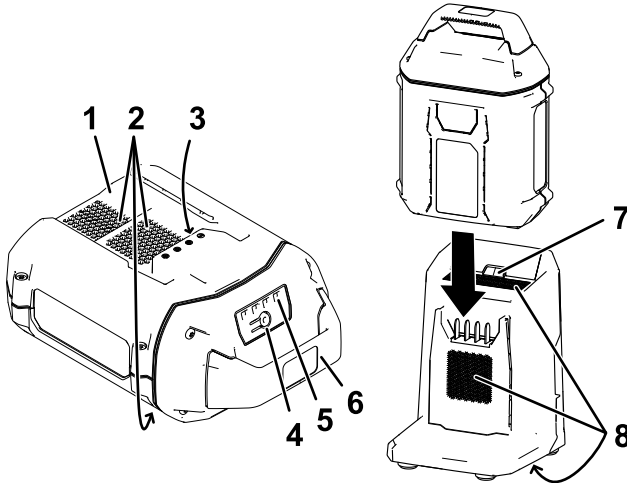

Figure 2

g290533

- | | |
|------------------------------------|------------------------------------|
| 1. Battery pack cavity | 5. LED indicators (current charge) |
| 2. Battery pack venting areas | 6. Handle |
| 3. Battery pack terminals | 7. Charger LED indicator light |
| 4. Battery-charge-indicator button | 8. Charger venting areas |

2. Line up the cavity in the battery pack ([Figure 2](#)) with the tongue on the charger.
3. Slide the battery pack into the charger until it is fully seated ([Figure 2](#)).
4. To remove the battery pack, slide the battery backward out of the charger.

5. Refer to the following table to interpret the LED indicator light on the battery charger.

Indicator light	Indicates
Off	No battery pack inserted
Green blinking	Battery pack is charging
Green	Battery pack is charged
Red	Battery pack and/or battery charger is over or under the appropriate temperature range
Red blinking	Battery pack charging fault*

*Refer to [Troubleshooting \(page 13\)](#) for more information.

Important: The battery can be left on the charger for short periods between uses.

If the battery will not be used for longer periods, remove the battery from the charger; refer to [Storage \(page 12\)](#).

Maintenance

Maintenance and servicing are not required under normal conditions.

When you clean the surface of the equipment, wipe it only with a dry cloth.

Do not disassemble the equipment; if it is damaged, contact your Authorized Service Dealer.

Storage

Important: Store the tool, battery pack, and charger only in temperatures that are within the appropriate range; refer to [Specifications \(page 9\)](#).

Important: If you are storing the tool for a year or longer, remove the battery pack from the tool and charge the battery pack until 2 or 3 LED indicators turn green on the battery. Do not store a fully charged or fully depleted battery. When you are ready to use the tool again, charge the battery pack until the left indicator light turns green on the charger or all 4 LED indicators turn green on the battery.

- Disconnect the product from the power supply (i.e., remove the battery pack) and check for damage after use.
- Clean all foreign material from the product.
- Do not store any machine with the battery pack installed.
- When not in use, store the tool, battery pack, and battery charger out of the reach of children.
- Keep the tool, battery pack, and battery charger away from corrosive agents, such as garden chemicals and de-icing salts.
- To reduce the risk of serious personal injury, do not store the battery pack outside or in vehicles.
- Store the tool, battery pack, and battery charger in an enclosed clean, dry area.

Preparing the Battery Pack for Recycling

Important: Upon removal, cover the terminals of the battery pack with heavy-duty adhesive tape. Do not attempt to destroy or disassemble the battery pack or remove any of its components.

Contact your local municipality or your authorized Toro distributor for more information on how to responsibly recycle the battery.

Troubleshooting

Perform only the steps described in these instructions. All further inspection, maintenance, and repair work must be performed by an authorized service center or a similarly qualified specialist if you cannot solve the problem yourself.

Problem	Possible Cause	Corrective Action
The battery pack loses charge quickly.	1. The battery pack is over or under the appropriate temperature range.	1. Move the battery pack to a place where it is dry and the temperature is between 5°C (41°F) and 40°C (104°F).
The battery charger is not working.	1. The battery charger is over or under the appropriate temperature range. 2. The outlet that the battery charger is plugged into does not have power.	1. Unplug the battery charger and move it to a place where it is dry and the temperature is between 5°C (41°F) and 40°C (104°F). 2. Contact your licensed electrician to repair the outlet.
The LED indicator light on the battery charger is red.	1. The battery charger and/or battery pack is over or under the appropriate temperature range.	1. Unplug the battery charger and move the battery charger and battery pack to a place where it is dry and the temperature is between 5°C (41°F) and 40°C (104°F).

Problem	Possible Cause	Corrective Action
<p>The LED indicator light on the battery charger is blinking red.</p>	<ol style="list-style-type: none"> 1. There is an error in the communication between the battery pack and the charger. 2. The battery pack is weak. 	<ol style="list-style-type: none"> 1. Remove the battery pack from the battery charger, unplug the battery charger from the outlet, and wait 10 seconds. Plug the battery charger into the outlet again and place the battery pack on the battery charger. If the LED indicator light on the battery charger is still blinking red, repeat this procedure again. If the LED indicator light on the battery charger is still blinking red after 2 attempts, properly dispose of the battery pack at a battery recycling facility. 2. Properly dispose of the battery pack at a battery recycling facility.
<p>The tool does not run or does not run continuously.</p>	<ol style="list-style-type: none"> 1. There is moisture on the leads of the battery pack. 2. The battery is not fully installed into the tool. 	<ol style="list-style-type: none"> 1. Allow the battery pack to dry or wipe it dry. 2. Remove and then replace the battery into the tool making sure that it is fully installed and latched.

Notes:

EEA/UK Privacy Notice

Toro's Use of Your Personal Information

The Toro Company ("Toro") respects your privacy. When you purchase our products, we may collect certain personal information about you, either directly from you or through your local Toro company or dealer. Toro uses this information to fulfill contractual obligations - such as to register your warranty, process your warranty claim or to contact you in the event of a product recall - and for legitimate business purposes - such as to gauge customer satisfaction, improve our products or provide you with product information which may be of interest. Toro may share your information with our subsidiaries, affiliates, dealers or other business partners in connection these activities. We may also disclose personal information when required by law or in connection with the sale, purchase or merger of a business. We will never sell your personal information to any other company for marketing purposes.

Retention of your Personal Information

Toro will keep your personal information as long as it is relevant for the above purposes and in accordance with legal requirements. For more information about applicable retention periods please contact legal@toro.com.

Toro's Commitment to Security

Your personal information may be processed in the US or another country which may have less strict data protection laws than your country of residence. Whenever we transfer your information outside of your country of residence, we will take legally required steps to ensure that appropriate safeguards are in place to protect your information and to make sure it is treated securely.

Access and Correction

You may have the right to correct or review your personal data, or object to or restrict the processing of your data. To do so, please contact us by email at legal@toro.com. If you have concerns about the way in which Toro has handled your information, we encourage you to raise this directly with us. Please note that European residents have the right to complain to your Data Protection Authority.