



Groundsmaster® 328-D

Traction Unit

Model No. 30630—210000001 and Up

Contents

Contents	2	Adjusting the Brakes	34
Introduction	3	Adjusting the Lift Lever Latch	35
Safety	4	Replacing the Hydraulic Oil Filter	36
Safe Operating Practices	4	Changing the Hydraulic System Oil	36
Safety and Instruction Decals	8	Fuses	37
Specifications	11	Servicing the Battery	37
Before Operating	13	Seasonal Storage	38
Hood Prop	13	Traction Unit	38
Check the Engine Oil	13	Engine	38
Filling the Fuel Tank	13		
Check the Cooling System	14		
Checking the Hydraulic System Oil	14		
Operation	16		
Controls	16		
Starting/Stopping the engine	18		
Bleeding the Fuel System	19		
Checking the Interlock Switches	19		
Pushing or Towing the Traction Unit	20		
Operating Characteristics	20		
Maintenance	22		
Recommended Maintenance Schedule	22		
Daily Maintenance Checklist	23		
Lubricating the Machine	23		
General Air Cleaner Maintenance	24		
Servicing the Air Cleaner	24		
Cleaning the Radiator and Screen	25		
Changing Engine Oil and Filter	25		
Servicing the Fuel System	26		
Cleaning Radiator and Screen	27		
Changing Coolant in the Cooling System	27		
Servicing the Engine Belts	28		
Adjusting the Throttle	29		
Adjusting the Traction Control Rod	29		
Adjusting the Traction Pedal Friction Wheel	30		
Adjusting the Traction Drive for Neutral	30		
Adjusting the Traction Interlock Switch	31		
Replacing the Power Take-Off Switch	32		
Correcting Power Take-Off Drive			
Belt Slippage	32		
Adjusting the Parking Brake Interlock			
Switch	32		
Adjusting the Tilt Steering Control	33		
Adjusting Rear Wheel Toe-In	33		
Adjusting the Rear Wheel Bearings	34		

©2001 by The Toro Company
8111 Lyndale Avenue South
Bloomington, MN 55420-1196
All Rights Reserved

Introduction

Read this manual carefully to learn how to operate and maintain your product properly. The information in this manual can help you and others avoid injury and product damage. Although Toro designs and produces safe products, you are responsible for operating the product properly and safely.

Whenever you need service, genuine Toro parts, or additional information, contact an Authorized Service Dealer or Toro Customer Service and have the model and serial numbers of your product ready. Figure 1 illustrates the location of the model and serial numbers on the product.

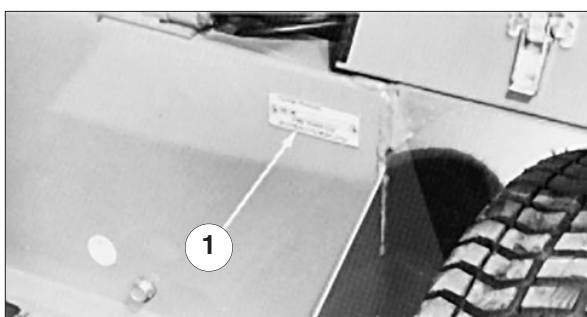

Figure 1

1. Location of the model and serial numbers

Write the product model and serial numbers in the space below:

Model No. _____
Serial No. _____

This manual identifies potential hazards and has special safety messages that help you and others avoid personal injury and even death. **Danger**, **Warning**, and **Caution** are signal words that identify the level of hazard. However, regardless of the hazard, be extremely careful.

Danger signals an extreme hazard that will cause serious injury or death if you do not follow the recommended precautions.

Warning signals a hazard that may cause serious injury or death if you do not follow the recommended precautions.

Caution signals a hazard that may cause minor or moderate injury if you do not follow the recommended precautions.

This manual uses two additional words to highlight information.

Important calls attention to special mechanical information and **Note**: emphasizes general information worthy of special attention.

Safety

Improper use or maintenance by the operator or owner can result in injury. To reduce the potential for injury, comply with these safety instructions and always pay attention to the safety alert symbol,  which means CAUTION, WARNING, or DANGER—“personal safety instruction.” Failure to comply with the instruction may result in personal injury or death.

Safe Operating Practices

The following instructions are from ANSI standard B71.4—1999.

Training

- Read the operator’s manual and other training material. If the operator(s) or mechanic(s) cannot read English it is the owner’s responsibility to explain this material to them.
- Become familiar with the safe operation of the equipment, operator controls, and safety signs.
- All operators and mechanics should be trained. The owner is responsible for training the users.
- Never let children or untrained people operate or service the equipment. Local regulations may restrict the age of the operator.
- The owner/user can prevent and is responsible for accidents or injuries occurring to himself or herself, other people or property.

Preparation

- Evaluate the terrain to determine the necessary accessories and attachments to properly and safely perform the job. Only use accessories and attachments approved by the manufacturer.
- Wear appropriate clothing including hardhat, safety glasses and ear protection. Long hair, loose clothing or jewelry may get tangled in moving parts.
- Inspect the area where the equipment will be

used and remove all objects such as rocks, toys and wire that can be thrown by the machine.

- Use extra care when handling gasoline and other fuels. They are flammable and vapors are explosive.
 - Use only an approved container.
 - Never remove the fuel cap or add fuel with the engine running. Let the engine cool before refueling. Do not smoke.
 - Never refuel or drain the machine indoors.
- Check that operator’s presence controls, safety switches and shields are attached and functioning properly. Do not operate unless they are functioning properly.

Operation

- Never run an engine in an enclosed area.
- Only operate in good light, keeping away from holes and hidden hazards.
- Be sure all drives are in neutral and the parking brake is engaged before starting the engine. Only start the engine from the operator’s position. Use seat belts, if provided.
- Slow down and use extra care on hillsides. Travel in the recommended direction on hillsides. Turf conditions can affect the machine’s stability. Use caution while operating near drop-offs.
- Slow down and use caution when making turns and when changing directions on slopes.
- Never raise the deck with the blades running.
- Never operate with guards not securely in place. Be sure all interlocks are attached, adjusted properly, and functioning properly.
- Do not change the engine governor setting or overspeed the engine.
- Stop on level ground, lower the cutting units,

move the traction pedal to neutral, disengage drives, engage the parking brake (if provided), and shut off the engine before leaving the operator's position for any reason.

- Stop equipment and inspect the blades after striking objects or if an abnormal vibration occurs. Make necessary repairs before resuming operations.
- Keep your hands and feet away from the cutting units.
- Look behind and down before backing up to be sure of a clear path.
- Never carry passengers and keep pets and bystanders away.
- Slow down and use caution when making turns and crossing roads and sidewalks. Stop blades if not mowing.
- Do not operate the mower under the influence of alcohol or drugs.
- Use care when loading or unloading the machine into a trailer or truck.
- Use care when approaching blind corners, shrubs, trees, or other objects that may obscure vision.
- The operator shall turn on flashing warning lights, if provided, whenever traveling on a public road, except where such use is prohibited by law.

Maintenance and Storage

- Disengage drives, lower the cutting units, move the traction pedal to neutral, set the parking brake, stop the engine and remove the key and disconnect the spark plug wire. Wait for all movement to stop before adjusting, cleaning or repairing.
- Clean grass and debris from the cutting units, drives, mufflers, and engine to help prevent fires.

Clean up oil or fuel spillage.

- Let the engine cool before storing and do not store it near flame.
- Shut off fuel while storing or transporting. Do not store fuel near flames or drain indoors.
- Park the machine on level ground. Never let untrained personnel service the machine.
- Use jack stands to support components when needed.
- Carefully release pressure from components with stored energy.
- Disconnect the battery or remove the spark plug wire before making any repairs. Disconnect the negative terminal first and the positive last. Reconnect positive first and negative last.
- Use care when checking blades. Wrap the blades or wear gloves, and use caution when servicing them. Only replace blades. Never straighten or weld them.
- Keep your hands and feet away from moving parts. If possible, do not make adjustments with the engine running.
- Charge batteries in an open, well-ventilated area, away from spark and flames. Unplug the charger before connecting or disconnecting it from the battery. Wear protective clothing and use insulated tools.
- Keep all parts in good working condition and all hardware tightened. Replace all worn or damaged decals.

Toro Mower Safety

The following list contains safety information specific to Toro products or other safety information that you must know.

This product can amputate hands and feet and throw objects. Always follow all safety instructions to avoid

serious injury or death.

Using this product for purposes other than its intended use could be dangerous to the user and bystanders.

Operation

- Always wear substantial shoes. Do not operate the machine while wearing sandals, tennis shoes, or sneakers.
- Wearing safety shoes and long pants is advisable and required by some local ordinances and insurance regulations.
- Fill the fuel tank until the level is 1 in. (25 mm) below the bottom of the filler neck. Do not overfill.
- Check the safety interlock switches daily for proper operation. If a switch should fail, replace the switch before operating the machine. After every two years, replace all three interlock switches in the safety system, regardless of whether or not they are working properly.
- The grass deflector(s) must always be installed and in the lowest position on the cutting unit.
- Pay attention when using the machine. To prevent loss of control:
 - Drive slowly.
 - Do not drive close to sand traps, ditches, creeks, or other hazards.
 - Reduce speed when making sharp turns. Avoid sudden stops and starts.
 - Lower the cutting unit when going down slopes.
- Do not touch the engine, radiator, or muffler while the engine is running or soon after it has stopped because these areas might burn you.
- If a cutting blade strikes a solid object or vibrates abnormally, disengage the power take off, move the throttle to Slow, set the parking brake, stop the engine, and remove the ignition key. Wait for all motion to stop, and inspect the machine for damage. Repair or replace any damaged parts before operating. Ensure that the cutting blades are in good condition and the blade bolts are torqued to proper specifications (see the cutting deck operator's manual).
- Check carefully for overhead clearances such as branches, doorways, and electrical wires before driving under any objects. Do not contact the objects.
- Make sure that the seat belt can be removed quickly if the machine is driven or rolls into a pond or lake.
- If the engine stalls or the machine loses headway and cannot get to the top of a slope, do not turn the machine around. Always back slowly straight down the slope.
- If the cutting unit discharge area ever plugs, disengage the power take off and shut the engine off before removing the obstruction.
- When operating a 4-wheel drive machine or any machine on slopes, by banks, or drop offs, always have the roll-over protection system installed.
- When operating the machine with the roll-over protection system, always use the seat belt and make sure that the seat pivot retaining pin is installed.

Maintenance and Storage

- Before servicing or making adjustments, stop the engine and remove the ignition key.
- Ensure that the entire machine is properly maintained and in good operating condition. Frequently check all nuts, bolts, and screws. Check all cutting unit blade bolts frequently to ensure that they are torqued to proper specifications (see the cutting deck operator's manual).
- Make sure all hydraulic line connectors are tight and all hydraulic hoses and lines are in good

condition before applying pressure to the system.

- Keep your body and hands away from pin hole leaks or nozzles that eject hydraulic fluid under high pressure. Use paper or cardboard, not your hands, to search for leaks. Hydraulic fluid escaping under pressure can have sufficient force to penetrate the skin and cause serious injury.
- Before disconnecting or performing any work on the hydraulic system, all pressure in the system must be relieved by stopping the engine and lowering the cutting units.
- If the engine must be running to perform a maintenance adjustment, keep hands, feet, clothing, and all body parts away from the cutting units, attachments, power take off shaft, and any moving parts.
- Do not overspeed the engine by changing governor settings. To ensure safety and accuracy, have an authorized Toro distributor check the maximum engine speed with a tachometer. Maximum governed engine speed with no load should be 3200–3250 RPM.
- The engine must be shut off before checking the oil or adding oil.
- Periodically inspect the roll bar and roll bar mounting.

Replace, if necessary. Do not modify roll over protection frames or structures because they are specifically designed, sized, located, and tested for injury reduction. If a rollover occurs, a modified roll-over protection system will not provide adequate protection.

- If major repairs are ever needed or if assistance is desired, contact an authorized Toro distributor.
- For optimum performance and continued safety certification of the machine, use only genuine Toro replacement parts and accessories. Replacement parts and accessories made by other manufacturers could be dangerous, and such use could void the product warranty.

Safety and Instruction Decals



Safety decals and instructions are easily visible to the operator and are located near any area of potential danger. Replace any decal that is damaged or lost.

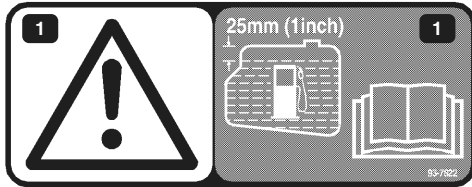

93-7822

1. Caution—fill the fuel tank to 1 in. (25 mm) below the filler neck. Read the operator's manual for further instructions.

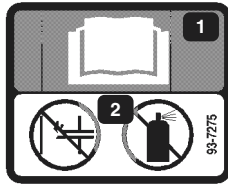

93-7275

1. Read the operator's manual for further instructions.
2. Do not use starting fluid.



93-6680

1. Diesel fuel

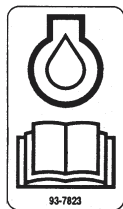

93-7823

1. Read the operator's for further information about engine oil.



82-8940

1. Locks and unlocks the steering column

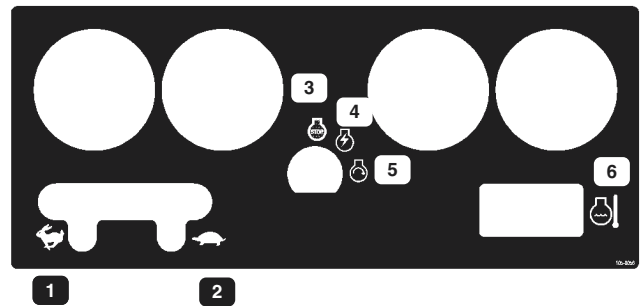

105-0056

1. Fast
2. Slow
3. Engine stop
4. Engine run
5. Engine start
6. Temperature

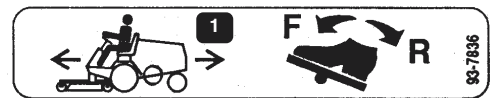

93-7836

1. To move the traction unit forward or backward, depress the traction pedal.



93-6696

1. Warning—spring-loaded mechanism. Read the operator's manual for further instructions.

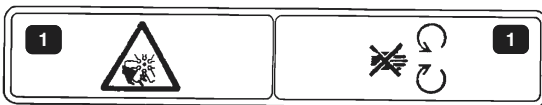

93-7272

1. Fan blades can cause injury—stay away from moving parts.



93-7830

1. Caution—read the operator's manual for further instructions.
2. Wheel torque specifications

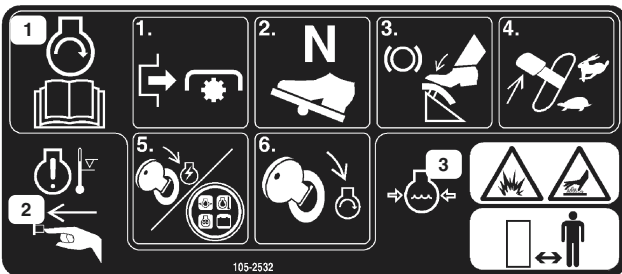

105-2532

1. To start the engine, disengage the power take off, place the traction drive in neutral, depress the brake pedal, set the throttle control half open, turn the ignition key to the run position. When the glow light turns off, turn the key to the start position. Read the operator's manual for further instructions.
2. Warning—when engine temperature is too high, the engine will shut off. Depress high temperature reset before restarting the engine.
3. Warning—coolant is under pressure and could cause burns. Keep a safe distance away.



93-7831

1. Parking brake—read the operator's manual for further instructions.

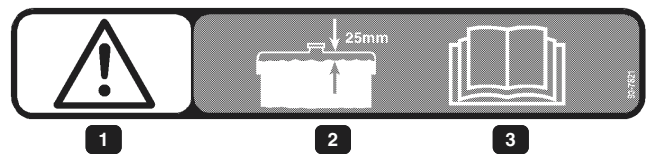

93-7821

1. Caution
2. Fill coolant to within 1 in. (25 mm) of the top of the tank.
3. Read the operator's manual for further instructions.

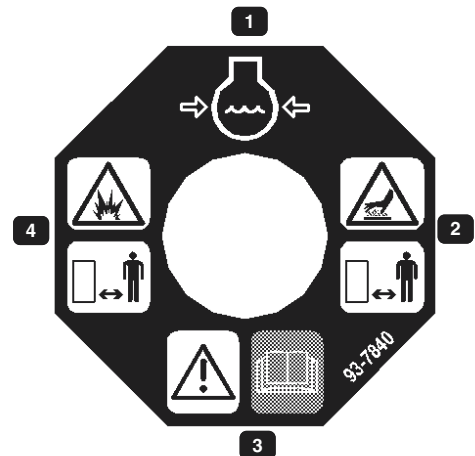

93-7840

1. Coolant level
2. Hot surface—stay away.
3. Warning—read the operator's manual.
4. Explosion hazard—stay away.

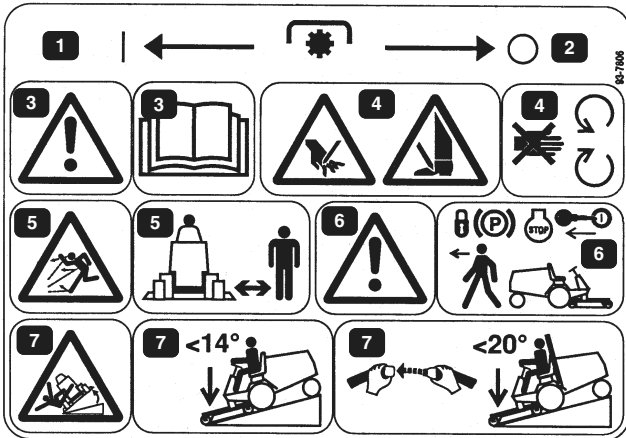

93-7806

1. Power take off on
2. Power take off off
3. Warning—read the operator's manual.
4. Cutting hazard to hands or feet—stay away from rotating blades and moving parts.
5. Throw object hazard—keep bystanders away.
6. Warning—set the parking brake, stop the engine, and remove the key before leaving the operator's position.
7. Tipping hazard—when driving down slopes less than 14 degrees, lower the cutting unit to the ground. When driving down slopes less than 20 degrees, use the roll-over protection system, fasten the seat belt, and lower the cutting unit to the ground.

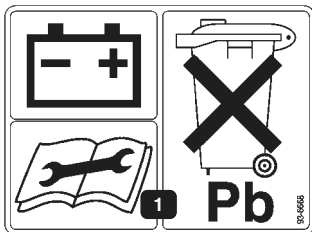

93-6668

1. The battery contains lead. Do not throw it in the garbage.

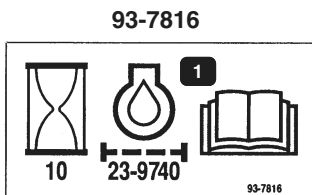

93-7816

1. Change the hydraulic filter after first 10 operating hours—read the operator's manual for further instructions.

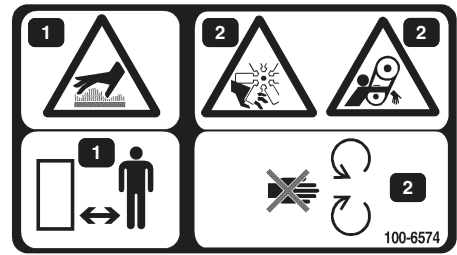

100-6574

1. Hot surface hazard—stay away.
2. Cutting/dismemberment hazard—stay away from moving parts.

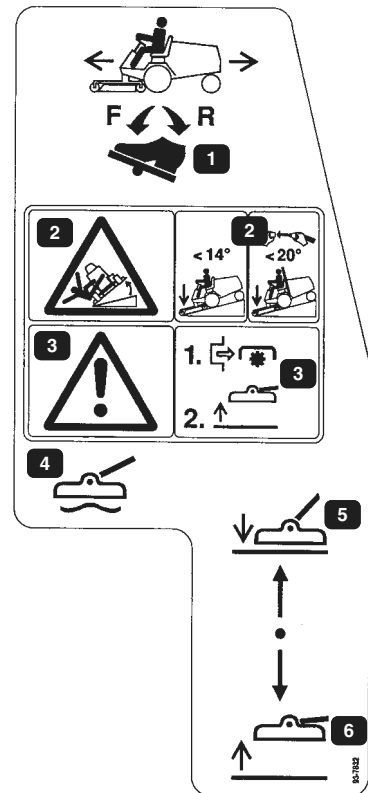

93-7832

1. To move the traction unit forward or backward, depress the traction pedal.
2. Tipping hazard—when driving down slopes less than 14 degrees, lower the cutting unit to the ground. When driving down slopes less than 20 degrees, use the roll-over protection system, fasten the seat belt, and lower the cutting unit to the ground.
3. Warning—disengage the power take off before raising the cutting unit.
4. Float cutting unit
5. Lower the cutting unit
6. Raise the cutting unit

Specifications

Note: Specifications and design subject to change without notice.

General Specifications

Engine	Kubota, three-cylinder, 4-cycle liquid cooled diesel engine. 26 hp @ 3000. The engine is governed to 3200–3250 rpm high idle, no load.
Air Cleaner:	Heavy-duty, remote mounted
Muffler:	Volume equal to approximately five times engine displacement for excellent silencing.
Cooling System	The radiator has tube-and-fin construction with the hydraulic oil cooler in the lower tank. Cooling system capacity is approximately 6 quarts (5.7 l) of a 50% mixture of permanent, ethylene glycol anti-freeze and water.
Electrical	The 12-volt battery has 630-amp., cold cranking performance at 0° F (– 18° C). The fuse block is located under the control panel.
Fuel System	Fuel tank capacity is approximately 6-½ gal. (25 l). 12-volt electric fuel pump . Fuel filter/water separator with replaceable cartridge is mounted on frame.
Front Axle	The heavy-duty Dana GT 20 axle has a 20:9:1 reduction. Axle has automotive-type differential, bevel gear pinion and ring gear with spur gear reduction from transmission. All axle components are mounted in tapered roller bearings.
Transmission	A Sauer-Danfoss, in-line hydrostatic transmission is mounted directly to the front axle and driven by flexible drive couplings. Operating pressure is 500 to 3000 psi (3447 to 20685 kPa) and normal charge pressure is 70 to 150 psi (453 to 1034 kPa). The implement relief valve setting is 700 to 900 psi (4826 to 6205 kPa). Displacement is 0.913 cubic inch (15 cm ³) per revolution, and transmission is controlled by foot-actuated pedal. Front axle is the hydraulic fluid reservoir, and its capacity is 5 quarts (4.7 l) of SAE 10W-30 or 10W-40 engine oil. The 25-micron hydraulic oil filter is a screw-on replaceable type. For replacement filters, order Toro Part No. 23-9740.
Ground Speed:	Speed is infinitely variable from 0 to 9.5 MPH (0 to 15 km/h) forward or reverse.
Tires	The two rear tires are 16 x 6.50-8, 4-ply, tubeless ribbed type, on demountable, drop-center wheels. The two front tires are 23 x 8.50-12, extra traction tread, 4-ply rating, on demountable wheels. Recommended air pressure for both the front and rear tires is 21 psi (145 kPa).
Brakes	The brakes are controlled by three pedals. Two are for steering assist, and are individually controlled by the driver's left foot. The third pedal operates both brakes; it is controlled by either foot. A parking brake latch is provided for the third pedal. Pedals are connected to brakes by a multi-stranded cable and conduit.
Steering	The 15-inch (38 cm) steering wheel is mounted on a steering valve consisting of a control valve and metering section, which regulates pressure and meters flow to the steering cylinder. Minimum turning radius is 18 in. from the center of a turn to the closest side of the drive wheel; however, zero turning radius occurs when individual wheel brakes are used. Steering wheel adjustable fore and aft for operator comfort.
Main Frame	The frame is welded 11-gauge steel, reinforced with square and rectangular tubing.

Interlock Switches Power take off switch—shuts the engine off when the power take off is engaged with no operator on the seat. Traction switch—shuts the engine off when the traction pedal is engaged with no operator on the seat. Seat switch—shuts the engine off if operator leaves the seat without disengaging the power take off and/or traction pedal. The engine will not start if the power take off or traction pedal is engaged. Brake switch—shuts the engine off when the power take off or traction pedal is engaged with the parking brake set.

Instrument Panel and Controls Hour meter, fuel gauge, oil pressure warning light, charge indicator, ignition switch, engine coolant temperature warning light, temperature gauge, temperature override switch, glow plug indicator light, and throttle control are on instrument panel. Hand-operated power take-off lever is located the right of the seat. Traction pedal for traction operation at the right of the steering column.

Power Take Off Drive Directly clutched by a belt from the engine’s output shaft. It is clutched by pivoting the shaft support with a hand-operated lever. Power take-off speed is 1810 rpm@3200 rpm engine speed. The implement is connected with a high-quality universal joint.

Implement Lift Cutting unit or the implement is lifted by a hydraulic cylinder that has 2-½ in. (64 mm) bore and 3-¼ in. (82 mm) stroke.

Dimensions and Weights (approx.)

Width:	46 in. (117 cm)	Quick Attach (for 72” Side Discharge Cutting Unit, Model No. 30722, 72” Rear Discharge Cutting Unit, Model No. 30710 and Rotary Broom, Model No. 30743)	Model No. 30719
Length:	91 in. (231 cm)		
Height:	50 in. (127 cm)		
w/roll-over protection system:	78.5 in. (199 cm)		
Dry Weight:	1250 lb. (567 kg)		
Wheel Base:	49 in. (124 cm)		

Tire Chains (front) (set of 2)	Part No. 11-0390
Wheel Weight Kit (set of 2)	Part No. 11-0440
Rear Weight Kit (set of 2)	Part No. 24-5780
Rear Weight Kit (set of 1)	Part No. 24-5790
4-Ply Wide Tire w/Rim, 23 x 10.5 x 12 (2 required; will not fit with 72” Rear Discharge Deck, Model No. 30710)	Part No. 69-9870

Optional Equipment

72” Side Discharge Cutting Unit	Model No. 30722		
72” Rear Discharge Cutting Unit	Model No. 30710		
72” Flex Deck Cutting Unit	Model No. 30799		
Guardian 72 , Recycler Cutting Unit	Model No. 30716		
Cushion Seat	Model No. 30623		
Deluxe Suspension Seat Kit (requires Model No. 30628)	Model No. 30625		
	Model No. 30711	6-Ply Wide Tire w/Rim 23 x 10.5 x 12 (2 required; will not fit with 72” Rear Discharge Deck, Model No. 30710)	Part No. 62-7020
	Model No. 30729		
Seat Adapter Kit	Model No. 30628	Jack Pad Kit	Part No. 76-0900
Armrest Kit	Model No. 30707		
Speed Control Kit	Model No. 30677		
48 in. V-Plow (requires Model No. 30757)	Model No. 30750		
V-Plow Mounting Kit (without tire chains)	Model No. 30757		
Debris Blower	Model No. 30855		
Spark Arrestor Screen	Part No. 75-6880		
Rotary Broom	Model No. 30743		

Quick Attach Receiver Kit (for traction unit) Model No. 30711

Quick Attach (for Guardian 72 , Recycler Model No. 30729 Cutting Unit, Model No. 30716

Before Operating

Hood Prop

(Model 30630 only)

1. Position the machine on a level surface.
2. Disengage the hood latch and open the hood.
3. Slide the bottom of the hood prop (Fig. 2) from the retaining bracket. Lower the hood prop, pivot it upward, then downward to prop up the hood.

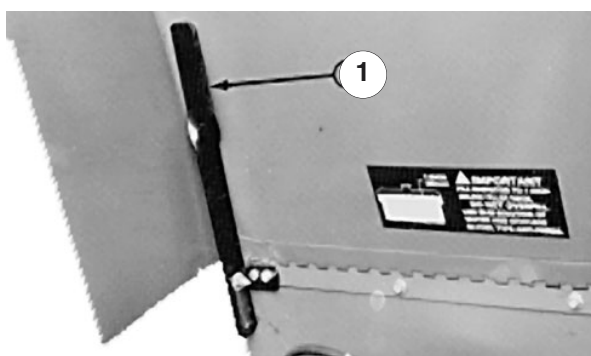

Figure 2

1. Hood prop

Check the Engine Oil

The engine is shipped with 4 qt (=3.8 l) of oil in the crankcase; however, the oil level must be checked before and after you first start the engine.

1. Park the machine on a level surface, stop the engine and remove the key from the ignition switch. Open the hood and install the hood prop.
2. Remove the dipstick (Fig. 3), wipe it clean and reinsert it. Remove the dipstick and check the oil level. The oil level should be to the FULL mark on the dipstick
3. If the oil level is below the FULL mark, remove the fill cap and add SAE 10W-30 CD, CE, CF, CF-4 or CG-4 classification oil until the level reaches the FULL mark on the dipstick. **DO NOT OVERFILL.**

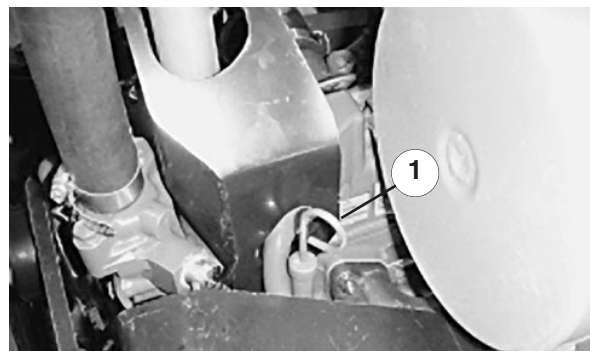

Figure 3

1. Dipstick

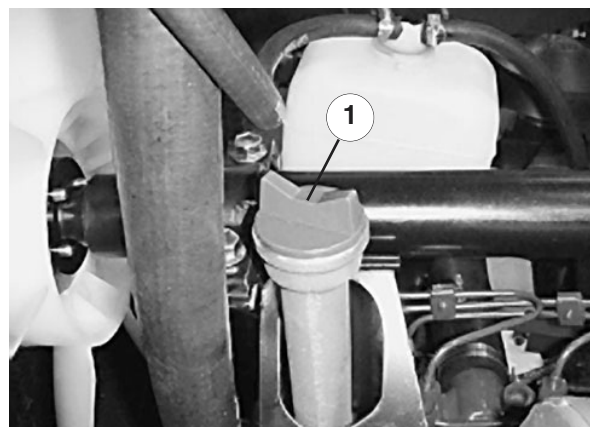

Figure 4

1. Oil fill

4. Install the oil fill cap and close the hood.

Filling the Fuel Tank

1. Tip the seat forward and prop it with the support rod so it cannot fall accidentally. Using a clean cloth, clean area around the fuel tank cap (Fig. 5).
2. Remove the cap from the fuel tank and fill the 6-½ gallon (25 l) tank to within 1 in. (25 mm) from the top with diesel fuel. Install the fuel tank cap tightly after filling tank.



DANGER



Under certain conditions, diesel fuel and fuel vapors are highly flammable and explosive. A fire or explosion from fuel can burn you and others and can cause property damage.

- Use a funnel and fill the fuel tank outdoors, in an open area, when the engine is off and is cold. Wipe up any fuel that spills.
- Do not fill the fuel tank completely full. Add fuel to the fuel tank until the level is 1 in. (25 mm) below the bottom of the filler neck. This empty space in the tank allows the fuel to expand.
- Never smoke when handling fuel, and stay away from an open flame or where fuel fumes may be ignited by a spark.
- Store fuel in a clean, safety-approved container and keep the cap in place.

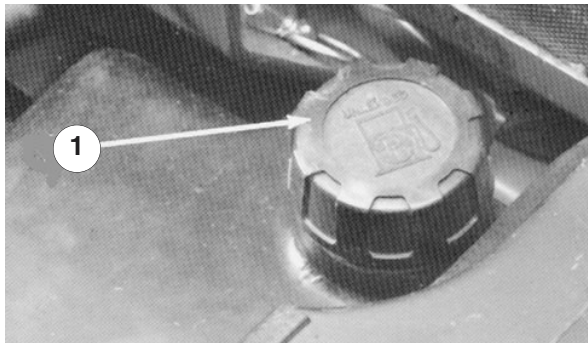

Figure 5

1. Fuel tank cap

Check the Cooling System

Clean debris from the screen and radiator/oil cooler daily, more often if conditions are extremely dusty and dirty.

The cooling system is filled with a 50/50 solution of water and permanent ethylene glycol anti-freeze. Check the coolant level in the expansion tank at the beginning of each day before starting the engine. Cooling system capacity is 6 quarts (5.6 l).

1. Check the coolant level in the expansion tank. It

should be between the marks on the side of the tank.



CAUTION



If the engine has been running, pressurized hot coolant can escape when the radiator cap is removed and cause burns.

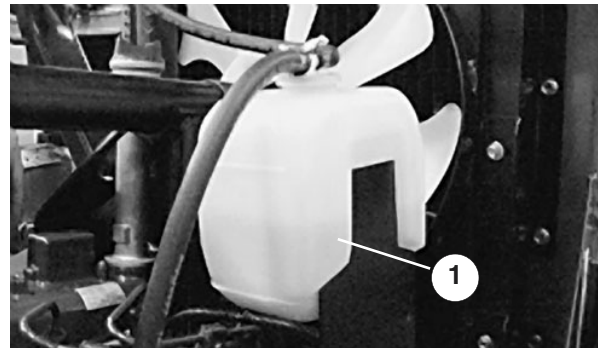

Figure 6

1. Expansion tank

2. If coolant level is low, remove the expansion tank cap and replenish the system. **DO NOT OVERFILL.**
3. Install the expansion tank cap.

Checking the Hydraulic System Oil

The hydraulic system is designed to operate on any high-quality detergent oil having the American Petroleum Institute—API —“ service classification” SF/CC or CD. Oil viscosity—weight—must be selected according to anticipated ambient temperature.

Temperature/viscosity recommendations are:

Expected Ambient Temperature	Recommended Viscosity and Type
(Extreme) over 32° C	SAE 30, Type SF/CC or CD engine oil
(Normal) 4–37° C	SAE 10W-30 or 10W-40, Type SF/CC or CD engine oil
(Cool) –1 to 10° C	SAE 5W-30, Type SF/CC or CD engine oil
(Winter) Below –1° C	Type “F” or “FA” ATF Automatic Transmission Fluid

Note: Do not mix engine oil and automatic transmission fluid or hydraulic system component damage may result. When changing fluids, also change transmission filter. Do not use Dexron II ATF.

Note: Cold weather start-up may result in “stiff” steering until the hydraulic system has warmed up. Using a proper weight hydraulic oil minimizes this condition.

The transmission and axle housing are shipped from the factory with approximately 5 quarts (4.7 l) of SAE 10W-30 engine oil. However, check the level of transmission oil before first starting the engine and daily thereafter.

1. Position the machine on a level surface, raise the implement, and stop the engine.
2. Unscrew the dipstick cap (Fig. 7) from the filler neck and wipe it with a clean cloth. Screw the dipstick cap finger-tight onto the filler neck, then unscrew the dipstick and check the oil level. If the level is not within ½ in. (13 mm) from the groove in the dipstick (Fig. 7), add enough oil to raise the level to the groove mark. Do not overfill by more than ½ in. (13 mm) above the groove.

Important When adding oil to the hydraulic system, use a funnel with a fine wire screen—200 mesh—and ensure the funnel and oil are immaculately clean. This procedure prevents accidental contamination of the hydraulic system.

3. Screw the dipstick filler cap finger-tight onto the filler neck. It is not necessary to tighten the cap

with a wrench.

4. Lower the implement.

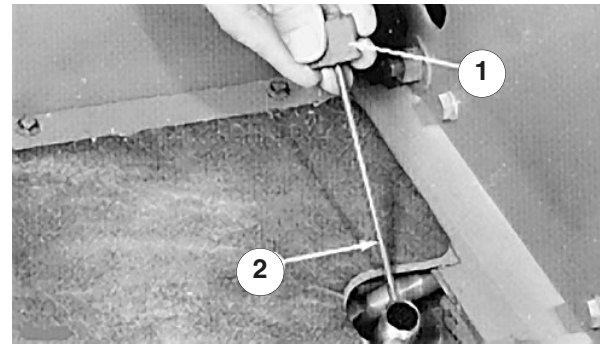

Figure 7

1. Dipstick cap
2. Groove

Operation

Note: Determine the left and right sides of the machine from the normal operating position.

Controls

Traction Pedal

The traction pedal (Fig. 8) makes the machine move forward and backward. Using the heel and toe of your right foot, press the top of the pedal to move forward and the bottom of the pedal to move backward.

Ground speed is proportionate to how far you press the pedal. For maximum ground speed with no load, the traction pedal must be fully depressed while the throttle is in the FAST position. Maximum speed forward is approximately 9.5 mph (15 km/h). For maximum power under a heavy load or when ascending a hill, have the throttle in the FAST position while depressing the traction pedal slightly to keep engine rpm high. If engine rpm begins to decrease, release the traction pedal slightly to allow engine rpm to increase.

⚠CAUTION⚠

When your foot is removed from the traction pedal, the machine should stop; It must not creep in either direction. If it does, don't operate it until the neutral assembly has been repaired and adjusted; refer to *Adjusting the Traction Drive for Neutral*, page 30.

Turn Pedals

The left- and right-turn pedals (Fig. 8) are connected to the left and right front wheel brakes, since both brakes work independently of each other. You can use the brakes to turn sharply or to increase traction if one wheel slips while operating on a hillside. However, wet grass or soft turf could be damaged when you use brakes to turn.

Tilt Steering Control

The tilt steering control is a lever on the right side of the steering column (Fig. 8). Pull the lever rearward to adjust steering wheel to desired fore or aft operating

position and push the lever forward to lock adjustment.

Brake Pedal

Whenever you shut off the engine, you must engage the parking brake (Fig. 8) to prevent accidental machine movement.

The hydrostatic transmission will not, at any time, act as a parking brake for the machine. To engage the parking brake, push down fully on the brake pedal and pull the parking brake knob out; then release the pedal. To release the parking brake, depress the brake pedal until the parking brake knob retracts. To stop quickly, remove your foot from the traction pedal and press the brake pedal. For straight stops, the brake cables must be evenly adjusted.

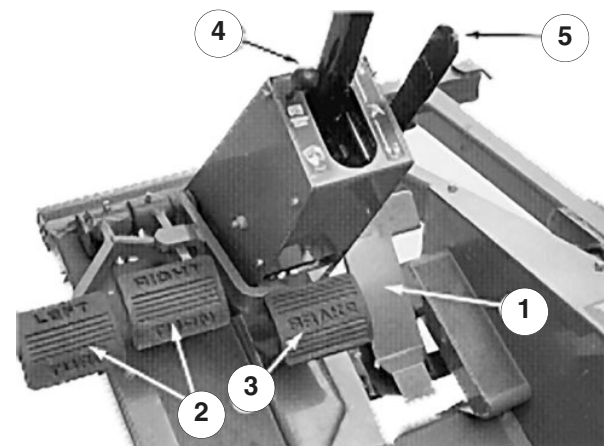

Figure 8

1. Traction pedal
2. Turn pedals
3. Brake pedal
4. Parking brake knob
5. Tilt steering control

Lift Lever

The hydraulic lift lever (Fig. 9) has three positions: FLOAT, TRANSPORT, and RAISE. To lower the implement to the ground, move the lift lever forward into the notch, which is the FLOAT position. The FLOAT position is used for operation and also when the machine is not in operation. To raise the implement, pull the lift lever backward to the RAISE position. After the implement is raised, allow the lift

lever to move to the TRANSPORT position. The implement should be raised when driving from one work area to another, except when descending steep slopes.



Figure 9

1. Lift lever

! **CAUTION** !

The exposed, rotating blades of the cutting unit or other implements are hazardous.

Never raise a cutting unit or implement while the blades or other components are rotating.

Power Take Off Lever

The power take-off lever (Fig. 10) has two positions: ON (engage) and OFF (disengage). Slowly push the power take-off lever fully forward to the ON position to start the implement or the cutting unit blades. Slowly, pull the lever backward to the OFF position to stop implement operation. The only time the power take-off lever should be in the ON position is when the implement or cutting unit is down in operating position.

Fuel Gauge

The fuel gauge (Fig. 10) indicates quantity of fuel remaining in the fuel tank.

Hour Meter

The hour meter (Fig. 10) shows the accumulated hours of engine operation.

Oil Pressure Warning Light

The oil pressure warning light (Fig. 10) glows when oil pressure in the engine drops below a safe level. If low oil pressure ever occurs, stop the engine and determine the cause. Repair the damage before starting the engine again.

Charge Indicator

Illuminates when the system charging circuit malfunctions (Fig. 10).

Engine Coolant Temperature Warning Light

The light illuminates and the engine shuts down when coolant reaches an excessively high temperature (Fig. 10).

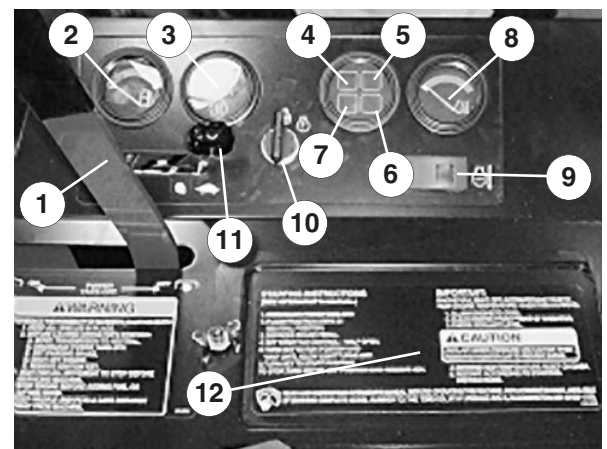

Figure 10

1. Power take-off lever
2. Fuel gauge
3. Hour meter
4. Oil pressure indicator
5. Engine temperature
6. Glow plug indicator
7. Charge indicator
8. Temperature gauge
9. Temperature override switch
10. Key switch
11. Throttle control
12. Battery cover

Temperature Gauge

The temperature gauge (Fig. 10) registers the temperature of the coolant in the cooling system. If temperature becomes too high, the engine will shut off automatically.

Temperature Override Switch

Press and hold the override switch to start the engine after a high-temperature shut down. Use it only for emergency operation.

Glow Plug Indicator

When lit, indicates glow plugs are on (Fig. 10).

Key Switch

Three positions: OFF, ON/Preheat and START (Fig. 10).

Throttle Control

Use the throttle (Fig. 10) to operate the engine at different speeds. Moving the throttle forward increases engine speed—FAST; moving it backward decreases engine speed—SLOW. The throttle regulates the speed of the cutter blades or other implement components and, with the traction pedal, controls the traction unit's ground speed.

Seat Adjusting Lever

To adjust the standard seat, push the lever (Fig. 11) backward and slide the seat to the desired position. Release the lever to lock the seat in place. The suspension seat may be adjusted forward or rearward by pulling out the lever at the left side of the seat, sliding the seat to the desired position, and releasing the lever. The weight adjustment knob may be adjusted for any operator's comfort.

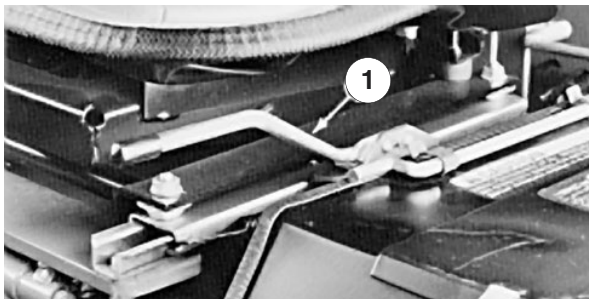

Figure 11

1. Seat adjusting lever

Starting/Stopping the engine

Important The fuel system must be bled if any of the following situations have occurred.

- A. Initial start up of a new machine.
- B. The engine has ceased running due to lack of fuel.
- C. Maintenance has been performed on fuel system components; i.e., filter replaced, separator serviced, etc.



Refer to *Bleeding the Fuel System*.

1. Set the parking brake, put the power take-off switch in the OFF position and the lift lever in the TRANSPORT or FLOAT position. Remove your foot from the traction pedal and make sure it is in neutral.
2. Move the throttle control to the ½-throttle position.
3. Turn the ignition switch to ON/Preheat position. An automatic timer will control preheat for 10 seconds. After preheat, turn the key to the START position. **CRANK THE ENGINE FOR NO LONGER THAN 15 SECONDS.** Release the key when the engine starts. If additional preheat is needed, turn the key to the OFF position then to the ON/preheat position. Repeat the process as needed.
4. Run the engine at idle speed or partial throttle until it warms up.

Note: Move the throttle to the ½-throttle position when restarting a warm engine.

5. When the engine is started for the first time, or after an engine oil change, or overhaul of the engine, transmission or axle, operate the machine in forward and reverse for one or two minutes. Also operate the lift lever and power take-off lever to assure all parts operate correctly. Turn the power steering wheel to the left and right to check steering response. Then shut the engine off and check fluid levels, check for oil leaks, loose



parts and any other noticeable malfunctions.

 CAUTION 
Shut off the engine and wait for all moving parts to stop before checking for oil leaks, loose parts or other malfunctions.

6. To stop the engine, move the throttle control backward to the SLOW position, move the power take-off switch to the OFF position and turn the ignition key to OFF. Remove the key from the switch to prevent accidental starting.

Bleeding the Fuel System

1. Park the machine on a level surface. Make sure the fuel tank is at least half full.
2. Unlatch and raise the hood.

 DANGER 
Under certain conditions, diesel fuel and fuel vapors are highly flammable and explosive. A fire or explosion from fuel can burn you and others and can cause property damage.
<ul style="list-style-type: none">• Use a funnel and fill the fuel tank outdoors, in an open area, when the engine is off and is cold. Wipe up any fuel that spills.• Do not fill the fuel tank completely full. Add fuel to the fuel tank until the level is 1 in. (25 mm) below the bottom of the filler neck. This empty space in the tank allows the fuel to expand.• Never smoke when handling fuel, and stay away from an open flame or where fuel fumes may be ignited by a spark.• Store fuel in a clean, safety-approved container and keep the cap in place.

3. Open the air bleed screw on the fuel injection pump (Fig. 12).

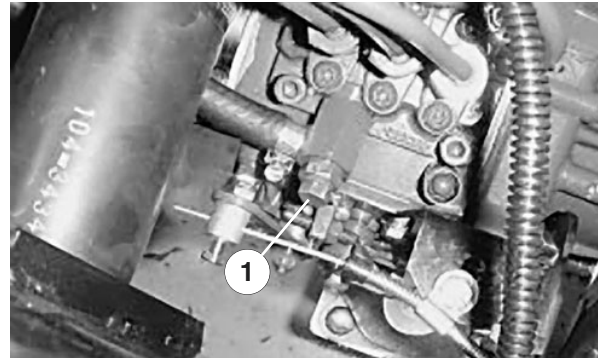



Figure 12

1. Fuel injection pump bleed screw

4. Turn the key in the ignition switch to ON. The electric fuel pump will begin operation, and force air out around the air bleed screw. Leave the key in the ON position until a solid stream of fuel flows out around the screw. Tighten the screw and turn the key to OFF.

Note: Normally, the engine should start after these bleeding procedures. However, if it doesn't, air may be trapped between the injection pump and injectors; refer to *Bleeding Air from Injectors*, page 27.

Checking the Interlock Switches

 CAUTION 
If safety interlock switches are disconnected or damaged the machine could operate unexpectedly causing personal injury.
<ul style="list-style-type: none">• Do not tamper with the interlock switches.• Check interlock switch operation daily and replace any damaged switches before operating the machine.• Replace switches every two years or 1,000 hours, whichever occurs first.

The machine has interlock switches in the electrical system. They are designed to stop the engine when you get off the seat while the power take-off lever is engaged or the traction pedal is depressed. However, you may get off the seat while the engine is running. Although the engine will continue to run if the power

take-off lever is disengaged and the traction pedal is released, it is strongly recommended that you stop the engine before dismounting from the seat.

To check interlock switch operation:

1. Drive the machine slowly to a large, relatively open area. Lower the cutting unit, stop the engine and apply the parking brake.
2. Sit on the seat. Move the power take-off lever to the ON position. With the traction pedal in neutral, try to start the engine. The engine should not crank. If it does, there is a malfunction in the interlock system that should be corrected before beginning operation.
3. Sit on the seat. Move the power take-off lever to OFF and depress the traction pedal. Try to start the engine. The engine should not crank. If it does, there is a malfunction in the interlock system that should be corrected before beginning operation.



WARNING



Do not operate the machine without an implement unless the power take-off drive shaft is also removed.

4. Sit on the seat and start the engine. Disengage the parking brake. Rise from the seat and move the power take-off lever to ON. The engine should stop within 2–3 seconds. If it doesn't, there is a malfunction in the interlock system that should be corrected before beginning operation.
5. Engage the parking brake. Depress the traction pedal while the engine is running and the power take-off lever is disengaged. The engine should stop within 2 seconds. If the engine stops, the switch is operating correctly. If it doesn't, there is a malfunction in the interlock system that should be corrected before beginning operation.

Pushing or Towing the Traction Unit

In an emergency, the traction unit can be pushed or

towed for a very short distance. However, Toro does not recommend this as standard procedure.

Important Do not push or tow the traction unit faster than 2 to 3 MPH (3 to 4.8 km/h) because the transmission may be damaged. If the traction unit must be moved a considerable distance, transport it on a truck or trailer. Whenever the traction unit is pushed or towed, the bypass valve must be open.

1. Reach under the traction unit and turn the bypass valve (Fig. 13) $\frac{1}{2}$ to 1 turn counterclockwise. Opening the valve opens an internal passage in the transmission, thereby bypassing transmission oil. Because fluid is bypassed, the traction unit can be moved without damaging the transmission.

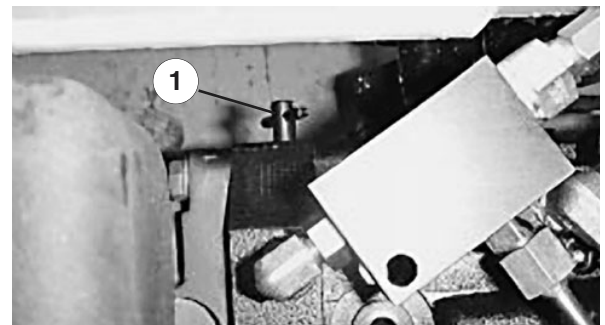

Figure 13

1. Bypass valve

2. Before starting the engine, close the bypass valve by turning it clockwise until it is securely seated. Do not exceed 5 to 8 ft.-lb. (7 to 11 N•m). Do not start the engine when the valve is open.

Important Running the machine with the bypass valve open will overheat the transmission.

Operating Characteristics

Practice driving the machine because it has a hydrostatic transmission and its characteristics are different than many turf maintenance machines. Some points to consider when operating the traction unit, cutting unit, or other implement are the transmission, engine speed, load on the cutting blades or other implement components, and the importance of the brakes.

To maintain enough power for the traction unit and implement while operating, regulate the traction pedal to keep engine rpm high and somewhat constant. A good rule is: decrease ground speed as the load on the implement increases, and increase ground speed as the load decreases.

Therefore, let the traction pedal move backward as engine rpm decrease, and depress the pedal slowly as rpm increase. By comparison, when driving from one work area to another—with no load and the cutting unit raised—have the throttle in the FAST position and depress the traction pedal slowly but fully to attain maximum ground speed.



Also consider the operation of the turning pedals that are connected to the brakes. You can use the brakes to help turn the machine. However, use them carefully, especially on soft or wet grass because the turf may be torn accidentally.

Another benefit of the turning brakes is to maintain traction. For example: in some slope conditions, the uphill wheel slips and loses traction. If this situation occurs, depress the up-hill turn pedal gradually and intermittently until the up-hill wheel stops slipping, thus, increasing traction on the downhill wheel.

Use extra care when operating the machine on slopes. Always have the seat pivot retaining pin installed. To prevent roll overs, drive slowly and avoid sharp turns on slopes. For steering control, the cutting deck must be lowered when going downhill.

The grass deflector must always be installed and in lowest position on the side discharge cutting unit.

Before stopping the engine, disengage all controls and move the throttle to SLOW. Moving the throttle to SLOW reduces high engine rpm, noise, and vibration. Turn the key to OFF to stop the engine.

	WARNING	
<p>Careless operation, combined with terrain angle, ricochets, or improperly positioned safety guards can lead to thrown object injuries.</p> <p>A person or pet may suddenly appear in or near the mowing area.</p> <p>Stop mowing and do not resume mowing until the area is cleared.</p>		

Maintenance

Note: Determine the left and right sides of the machine from the normal operating position.

Recommended Maintenance Schedule

Maintenance

Service Interval

Maintenance Procedure

After the first 10 hours

- Check the power take-off belt tension.
- Check the fan and alternator belt tension.
- Change the transmission filter.
- Torque the wheel lug nuts.

After first 50 hours

- Change the engine oil filter.
- Check engine RPM.

Every 50 hours

- Check the battery electrolyte level.
- Check the battery cable connections.
- Lubricate all grease fittings.
- Lubricate the brake cables.
- Check the cutting unit gear box oil level.
- Clean under the cutting unit belt covers.
- Check the cutting unit drive belt adjustment.
- Change the engine oil.
- Inspect the air filter.

Every 100 hours

- Change the engine oil filter.
- Check the power take off belt tension.
- Check the fan and alternator belt tension.
- Inspect the cooling system hoses.

Every 200 hours

- Service the air filter.
- Check rear wheel toe-in and steering linkage.
- Change the transmission filter.
- Torque the wheel lug nuts.

Every 400 hours

- Drain and clean the fuel tank.
- Replace the cutting unit gear box oil.
- Change the fuel filter.
- Change the fuel/water separator filter.
- Pack the rear wheel bearings.
- Adjust valves
- Check engine RPM.

Every 1000 hours or 2 years, whichever occurs first

- Replace moving hoses.
- Replace safety switches.
- Flush and replace the coolant system fluid.
- Replace the hydraulic oil.

Important

Refer to your engine operator's manual for additional maintenance procedures.

Daily Maintenance Checklist

- ✓ Check safety interlock operation.
- ✓ Check that the grass deflector is in the down position.
- ✓ Check brake operation.
- ✓ Check the engine oil level.
- ✓ Check the cooling system fluid level.
- ✓ Drain the water/fuel separator.
- ✓ Check the air cleaner.
- ✓ Check the radiator and screen for debris.
- ✓ Check unusual engine noises. ¹
- ✓ Check the transmission oil level.
- ✓ Check the hydraulic hoses for damage.
- ✓ Check for fluid leaks.
- ✓ Check the tire pressure.
- ✓ Check instrument operation.
- ✓ Check blade condition.
- ✓ Lubricate all grease fittings. ²
- ✓ Touch up damaged paint.

¹Check the glow plug and injector nozzles if hard starting, excess smoke, or rough running is noted.

²Immediately **after every** washing, regardless of the interval listed.

Lubricating the Machine

The traction unit must be lubricated regularly. If the machine is operated under normal conditions, lubricate all bearings and bushings after every 50 hours of operation or whenever water is used to clean the machine.

1. The traction unit bearings and bushings that must be lubricated are: power take off shaft and yokes (Fig. 14); lift arm pivots (Fig. 14); right and left push arm ball joints (Fig. 14); push arm pivot bushings (Fig. 15); power take off pivot housing blocks (Fig. 16); brake pivot bushings (Fig. 17); rear wheel spindle bushings (Fig. 18); steering

plate bushings (Fig. 18); axle pin bushing (Fig. 18) and engine output shaft bearing (Fig. 19). Also apply grease to both brake cables at the drive wheel and brake pedal ends.

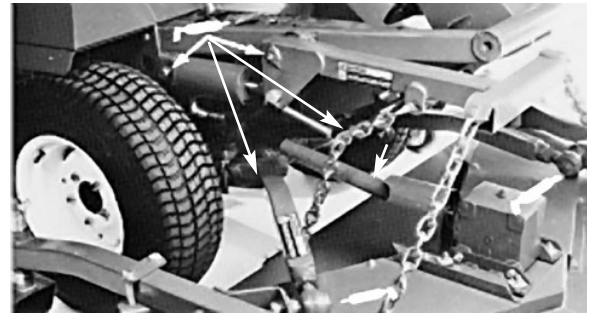

Figure 14

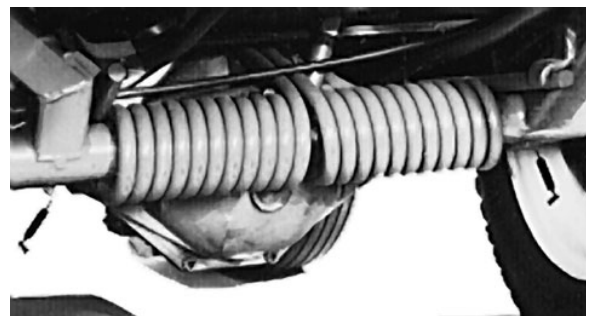

Figure 15

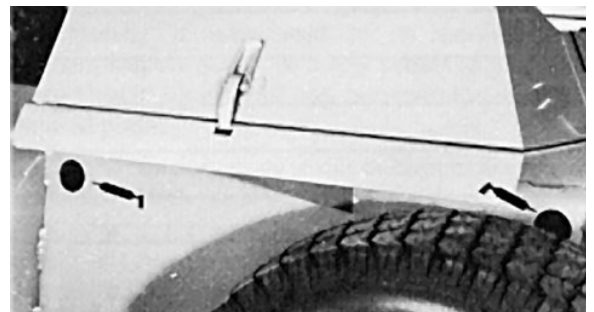

Figure 16

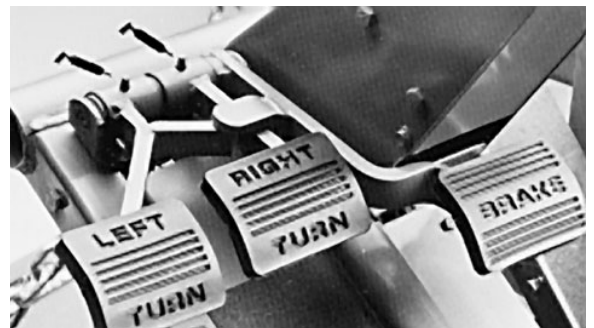

Figure 17

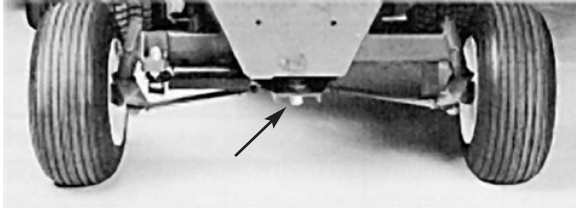

Figure 18

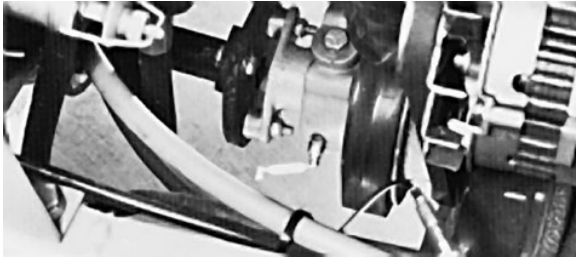

Figure 19

General Air Cleaner Maintenance

1. Check the air cleaner body for damage that could possibly cause an air leak. Replace a damaged air cleaner body.
2. Service the air cleaner filters when the air cleaner indicator (Fig. 20) shows red or every 400 hours (more frequently in extreme dusty or dirty conditions). Do not over service the air filter.

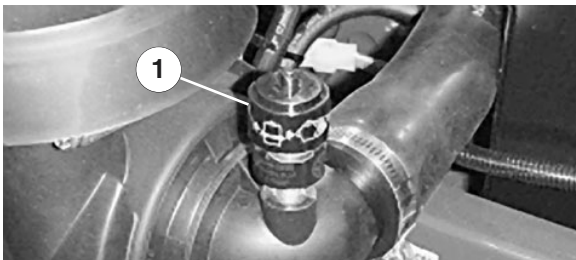

Figure 20

1. Air cleaner indicator

3. Be sure the cover seals around the air cleaner body.

Servicing the Air Cleaner

1. Pull the latch outward and turn the air cleaner cover counter-clockwise. Remove the cover from the body (Fig. 21). Clean inside of the air cleaner cover.

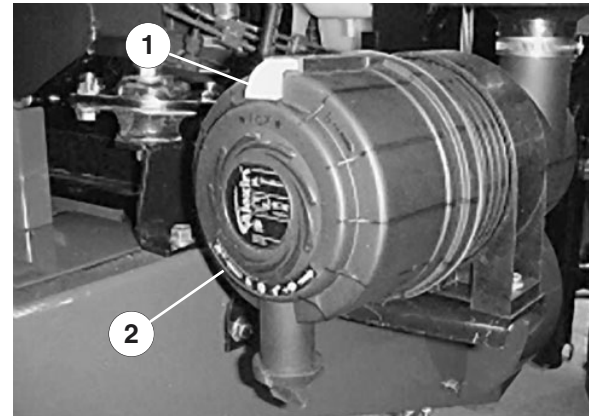

Figure 21

1. Air cleaner latch
2. Air cleaner cover

2. Gently slide the primary filter (Fig. 22) out of the air cleaner body to reduce the amount of dust dislodged. Avoid knocking the filter against the air cleaner body.

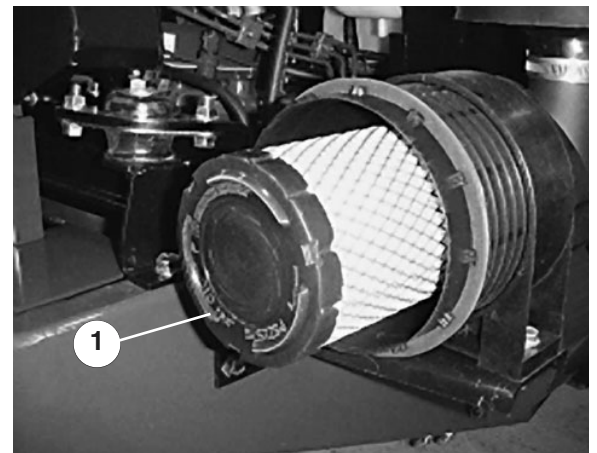

Figure 22

1. Primary filter

3. Inspect primary filter and discard if damaged. Do not wash or reuse a damaged filter.

Cleaning the Air Filter

- A. Blow compressed air from the inside to the outside of a dry filter element. To prevent damage to the element, don't exceed 689 kPa.
- B. Keep the air hose nozzle at least 5cm from the filter and move the nozzle up and down while turning the filter element. Inspect for holes and tears by looking through the filter

toward a bright light.

4. Inspect the new filter for shipping damage. Check the sealing end of the filter. Don't install a damaged filter.
5. Take care to insert the new filter correctly into the air cleaner body. Make sure the filter is sealed properly by applying pressure to the outer rim of the filter when installing. Don't press on the flexible center of the filter.
6. Reinstall the cover and secure the latch. Make sure the cover is positioned with the TOP side up.
7. Reset the indicator (Fig. 20) if it shows red.

Cleaning the Radiator and Screen

The screen and front of the radiator must be kept clean to prevent the engine from overheating. Check the screen and front of the radiator daily and, if necessary, clean any debris from these parts. However, in extremely dusty and dirty conditions, check and clean the screen each quarter hour and check the radiator every hour.

Note: This situation may be particularly prevalent if the rear discharge cutting unit is being used. The front of the radiator can be cleaned thoroughly by blowing with compressed air from the fan side of the radiator. Make sure to clean out any debris that settles to the bottom of the screen. The screen in front of the radiator can be removed—by loosening wing nuts at the top of screen—to make cleaning easier.

Changing Engine Oil and Filter

Check the oil level after each day's operation or each time the machine is used. Change the oil after every 50 hours of operation; change the oil filter after first 50 hours and every 100 hours operation thereafter. If possible, run the engine just before changing oil because warm oil flows better and carries more contaminants than cold oil.

1. Position the machine on a level surface.

2. Open the hood. Set drain pan under the oil pan and in line with drain plug (Fig. 23).

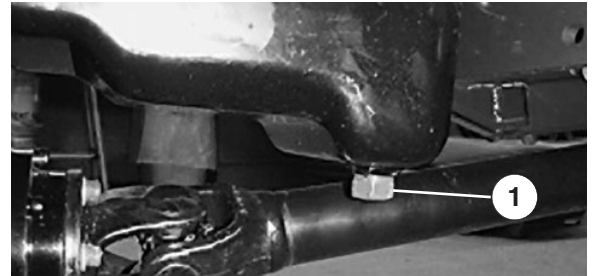

Figure 23

1. Drain plug

3. Clean the area around the drain plug.
4. Remove the oil drain plug and let oil flow into a drain pan.
5. Remove and replace the oil filter (Fig. 24).

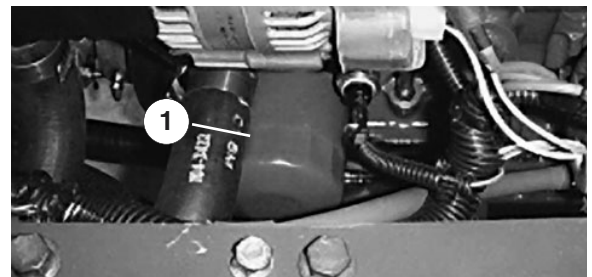

Figure 24

1. Oil filter

6. After the oil is drained, reinstall drain plug and wipe up any oil that is spilled.
7. Fill crankcase with oil; refer to *Check the Engine Oil*, page 13.

Servicing the Fuel System

Note: Refer to *Fill the Fuel Tank*, page 13, for fuel recommendations.

Under certain conditions, diesel fuel and fuel vapors are highly flammable and explosive. A fire or explosion from fuel can burn you and others and can cause property damage.

- Use a funnel and fill the fuel tank outdoors, in an open area, when the engine is off and is cold. Wipe up any fuel that spills.
- Do not fill the fuel tank completely full. Add fuel to the fuel tank until the level is 25 mm below the bottom of the filler neck. This empty space in the tank allows the fuel to expand.
- Never smoke when handling fuel, and stay away from an open flame or where fuel fumes may be ignited by a spark.
- Store fuel in a clean, safety-approved container and keep the cap in place.

Fuel Tank

Drain and clean the fuel tank after every 800 hours operation or yearly, whichever comes first. Also, drain and clean the tank if the fuel system becomes contaminated or if the machine will be stored for an extended period. Use clean diesel fuel to flush out the tank.

Fuel Lines and Connections

Check the fuel lines and connections every 400 hours or yearly, whichever comes first. Inspect for deterioration, damage or loose connections.

Water Separator

Drain water or other contaminants from the water separator (Fig. 25) daily.

1. Place a clean container under the water separator (the water separator is mounted to the inside of the frame, next to the left side of the engine).

2. Loosen the drain plug on the bottom of the filter canister. Tighten the plug after draining.

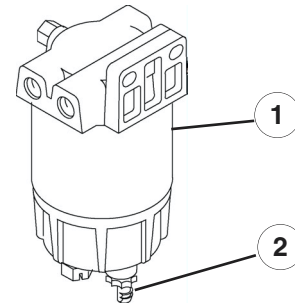

Figure 25

1. Water separator
2. Drain plug

Replace the filter canister after every 400 hours of operation.

1. Clean the area where the filter canister mounts.
2. Remove the filter canister and clean the mounting surface.
3. Lubricate the gasket on the filter canister with clean oil.
4. Install the filter canister by hand until the gasket contacts the mounting surface, then rotate an additional $\frac{1}{2}$ turn.

Replacing the Fuel Pre Filter

Replace the fuel pre filter (Fig. 26), located between the fuel tank and fuel pump after every 400 operating hours or yearly, whichever occurs first.

1. Clamp both fuel lines that connect to the fuel filter so fuel cannot drain when you remove the lines.
2. Loosen the hose clamps at both ends of the filter and pull the fuel lines off the filter.

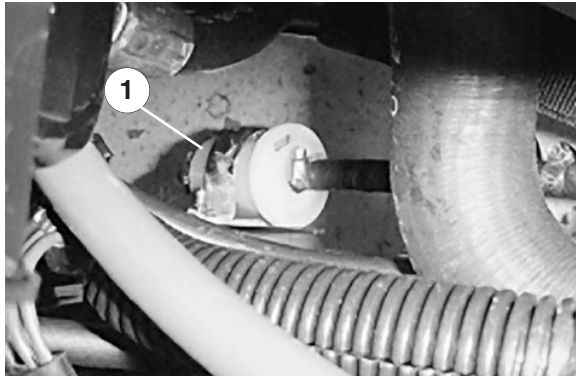

Figure 26

1. Fuel pre filter

3. Slide hose clamps onto the ends of the fuel lines. Push the fuel lines onto the fuel filter and secure them with hose clamps. Be sure the arrow on the side of the filter points toward the injection pump.

Bleeding Air from Injectors

Note: This procedure should be used only if the fuel system has been purged of air through normal priming procedures and the engine will not start; refer to *Bleeding the Fuel System* page 19.

1. Loosen the pipe connection to the No. 1 injector nozzle and holder assembly at the injection pump (Fig. 27).

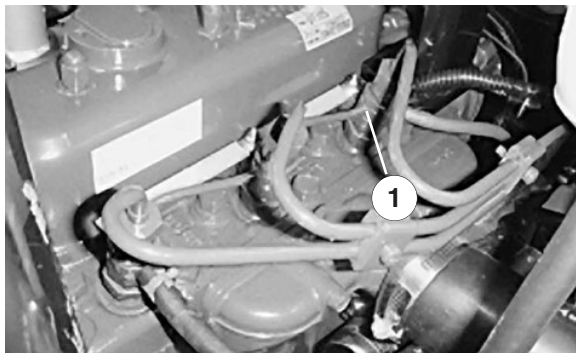

Figure 27

1. No. 1 injector nozzle

2. Move the throttle to FAST.
3. Turn the key in the key switch to START and watch fuel flow around the connector. Turn the key to OFF when you observe solid flow.
4. Tighten the pipe connector securely.

5. Repeat the previous steps on the remaining nozzles.

Cleaning Radiator and Screen

To prevent engine overheating, keep the screen and radiator clean. Normally, check the screen and radiator daily and, if necessary, clean any debris from these parts. However, it will be necessary to check and clean the screen and radiator frequently in extremely dusty and dirty conditions.

Note: If the engine shuts off due to overheating, first check the radiator and screen for an excessive buildup of debris.

To thoroughly clean the radiator:

1. Remove the screen.
2. Working from the fan side of the radiator, either spray the radiator with a water hose or blow with compressed air.
3. After the radiator is thoroughly cleaned, clean out debris that may have collected in the channel at the radiator base.
4. Clean and install the screen.

Changing Coolant in the Cooling System

Capacity of cooling system is approximately 6 quarts (5.7 L). The cooling system must be filled with a 50/50 solution of water and permanent ethylene glycol anti-freeze. Every two years, drain the coolant from the radiator by opening the drain cock (Fig. 28). After coolant has drained, flush the entire system and refill it with a 50/50 solution of water and anti-freeze.

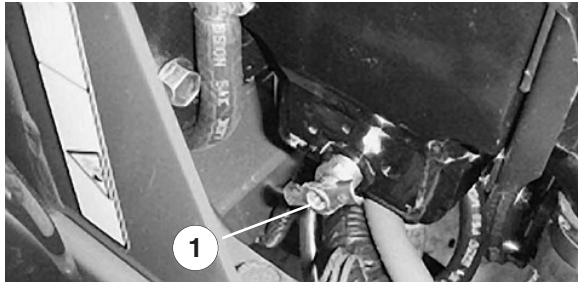

Figure 28

1. Drain cock

When filling the radiator, the coolant level must be above the core and 1 inch (25 mm) below the bottom of the filler neck. **DO NOT OVERFILL.** Always install the radiator cap (Fig. 29) securely.

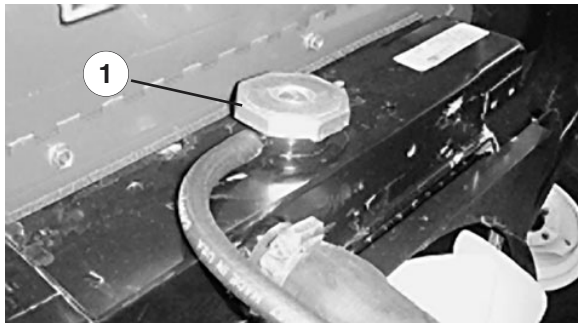

Figure 29

1. Radiator cap

The level of coolant in the expansion tank (Fig. 30) should be between the marks on the side of the tank.

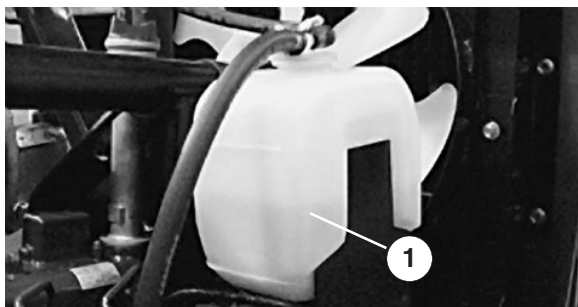

Figure 30

1. Expansion tank

Servicing the Engine Belts

Check the tension of all belts initially after the first day of operation and every 100 hours thereafter.

Alternator Belt

1. Unlatch and open the hood.
2. Proper tension will allow $\frac{3}{8}$ in. (10 mm) deflection when a force of 10 lbs. is applied on the belt (Fig. 31) midway between the pulleys.
3. If deflection is not $\frac{3}{8}$ in. (10 mm), loosen the alternator mounting bolts. Increase or decrease alternator belt tension and tighten the bolts. Check belt deflection again to assure tension is correct.

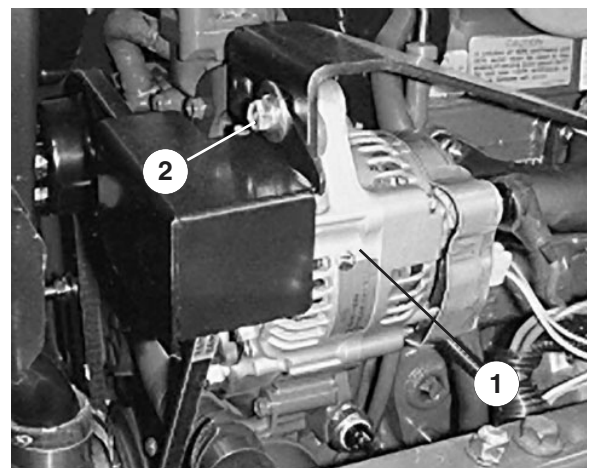

Figure 31

1. Alternator
2. Mounting bolt

Cooling Fan Belt

1. Unlatch and open the hood.
2. Remove the capscrews (5) securing the fan belt guard and remove the guard (Fig. 32).

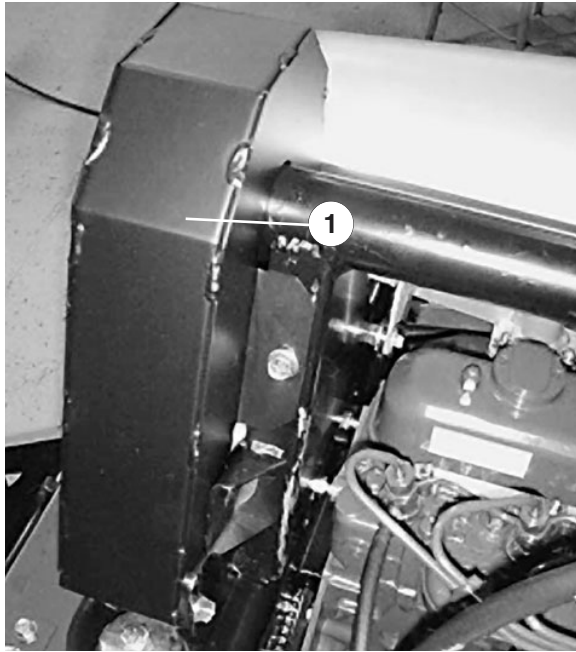

Figure 32

1. Fan belt guard

3. The belt should deflect $\frac{1}{4}$ in. (6 mm) midway between the pulleys with 5 lb. force (22 N•m) (Fig. 33). If deflection is incorrect, go to step 4. If correct, go to step 5.

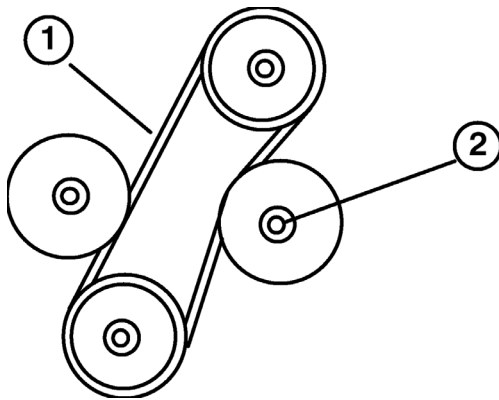

Figure 33

1. $\frac{1}{4}$ in. (6 mm) deflection here
2. Adjustable Idler pulley locknut

4. Loosen the locknut securing the adjustable idler pulley (Fig. 33). Push the idler pulley against the belt until proper deflection is achieved, then tighten the idler pulley locknut (Fig. 33).
5. Install the fan belt guard and secure it with capscrews (Fig. 32). Close and latch the hood.

To replace the belt:

1. Follow the procedures in step 1 and 2 above.
2. Loosen the locknut securing the adjustable idler pulley, slide the pulley away from the belt, and remove the belt from the pulleys (Fig. 33).
3. Install the new belt and adjust its tension. Push the idler pulley against the belt until the belt deflects $\frac{1}{4}$ inch (6 mm) with 5 lb. of force (22 N•m) midway between the top pulley and stationary idle pulley. Tighten the idler pulley locknut to secure adjustments (Fig. 33).
4. Install the fan belt guard and secure it with capscrews (Fig. 32). Close and latch the hood.

Note: Check the fan belt tension after the first day's operation. Readjust tension, if necessary. Follow regular maintenance check procedure thereafter.

Adjusting the Throttle

1. Adjust the throttle cable (Fig. 34) so the governor lever on the engine contacts the low- and high-speed set bolts before the throttle lever contacts the slot in the control panel.

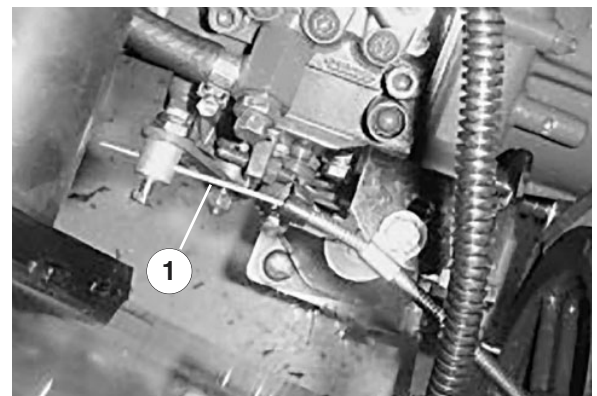

Figure 34

1. Throttle cable

Adjusting the Traction Control Rod

1. Check the traction drive neutral position to assure the front wheels do not creep; refer to *Adjusting the Traction Drive for Neutral*.

2. Press down on the front of the traction pedal and check travel. There should be approximately 89mm clearance between the end of the pedal and floor plate when the pedal is fully depressed (Fig. 35). Adjust the pump control rod (Fig. 36) to attain dimension.

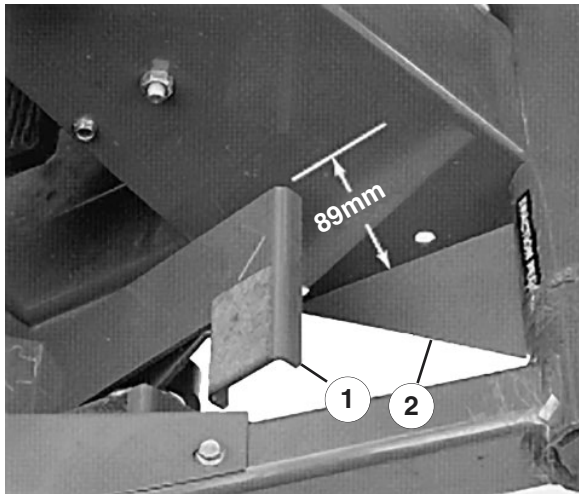

Figure 35

1. End of the pedal
2. Floor plate

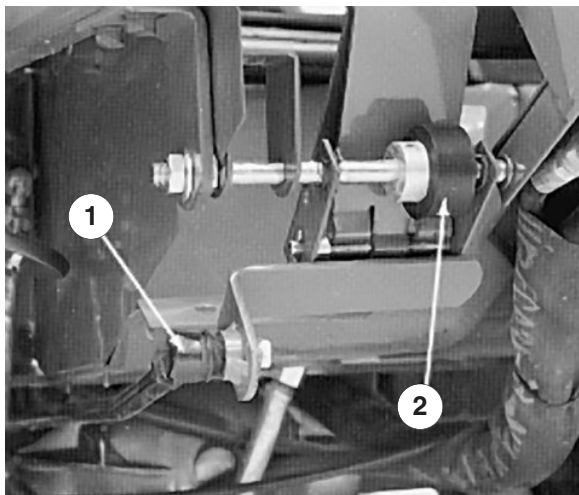

Figure 36

1. Control rod
2. Friction wheel

Adjusting the Traction Pedal Friction Wheel

1. Loosen the two nuts securing the traction pedal shaft on the right side of the pedal (Fig. 36).
2. Rotate the shaft to move the worn surface of the

friction wheel away from the underside of the traction pedal.

3. Tighten the nuts to secure the shaft and wheel in position.

Adjusting the Traction Drive for Neutral

1. Park vehicle on a level surface and turn the engine off. Apply the parking brake, tip the seat forward, and actuate pump lever (Fig. 37) to ensure assembly is properly seated and operating freely. Correct any discrepancy.
2. Block the right front tire and both rear tires so the vehicle cannot roll forward or backward.
3. Jack up the frame so the left front wheel is off the shop floor. Use a jack stand to support the frame.
4. Start the engine and allow it to idle for 5 minutes to heat the transmission oil to operating temperature.
5. Release the parking brake; then check the left front wheel that is off shop floor. The wheel must not be rotating. If the wheel is rotating, go to step 11 for an adjustment. If the wheel is not rotating, go to step 13. Verify the adjustment with the throttle in the SLOW and FAST position.
6. Because the wheel is rotating, the pump plate must be adjusted. But before adjusting the pump plate, move the throttle to SLOW. If the wheel is rotating forward, loosen the capscrews, and lightly tap the bottom of the pump plate counterclockwise (Fig. 37). By contrast, tap the pump plate clockwise if wheel is rotating backward (Fig. 37). When the wheel stops rotating, tighten the capscrews holding the pump plate against the side of the transmission. Verify the adjustment with the throttle in the SLOW and FAST position.

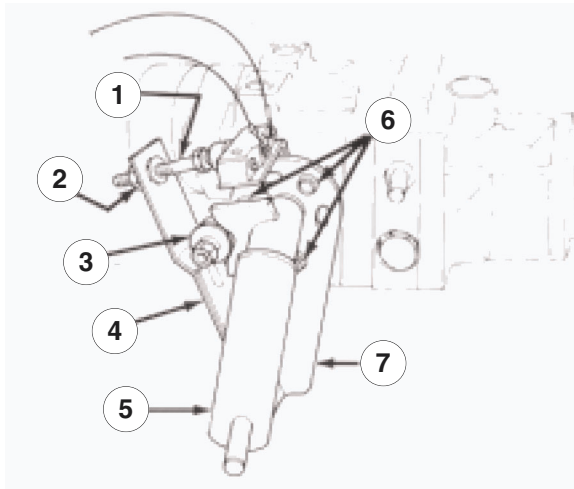

Figure 37

1. Switch adjusting screw
2. Jam nut
3. Ball bearing
4. Leaf springs
5. Pump lever
6. Capscrews
7. Pump plate

7. Block the right front tire and both rear tires so the vehicle cannot roll forward or backward.
8. Jack up the frame so the left front wheel is off the shop floor. Use a jack stand to support the frame.
9. Start the engine and allow it to idle for 5 minutes to heat the transmission oil to operating temperature.
10. Release the parking brake; then check the left front wheel that is off the floor. The wheel must not be rotating. If the wheel is rotating, go to step 11 for an adjustment. If wheel is not rotating, go to step 13. Verify the adjustment with the throttle in the SLOW and FAST position.
11. Because the wheel is rotating, the pump plate must be adjusted. But before adjusting the pump plate, move the throttle to SLOW. If the wheel is rotating forward, loosen the capscrews, and lightly tap the bottom of the pump plate counterclockwise (Fig. 37). By contrast, tap the pump plate clockwise if the wheel is rotating backward (Fig. 37). When wheel stops rotating, tighten the capscrews holding the pump plate against the side of the transmission. Verify the adjustment with the throttle in the SLOW and

FAST position.

12. If the front wheel continues to rotate, check for the following:
 - Loose or worn out ball bearing (Fig. 37).
 - The plunger on the interlock switch is sticking.
 - Loose or missing fasteners
 - Worn roll pin securing the pump lever to the transmission
 - The pump lever is loose on the control shaft. (Correct by applying Loc-tite 271 or 601 to shaft.)
 - Weak or damaged leaf springs (Fig. 37). Replace.
 - Internal transmission component malfunction. Contact your local Toro distributor for assistance.
13. Shut off the engine.
14. Adjust the traction control rod; refer to *Adjusting the Traction Control Rod*, page 29

Adjusting the Traction Interlock Switch

1. Adjust the transmission for neutral; refer to *Adjusting the Traction Drive for Neutral*, page 30.
2. Actuate the pump lever (Fig. 37) to ensure all parts are operating freely and seated properly.
3. Loosen the jam nut. Rotate the switch adjusting screw (Fig. 37) until there is a gap between the head of the screw and the switch button.
4. Rotate the adjusting screw until it contacts the switch button. Continue to rotate the screw until the circuit is completed (switch “clicks”). After the switch clicks, rotate the adjusting screw an additional ½ turn. Tighten the jam nut.

Replacing the Power Take-Off Switch

1. Remove the instrument cover and disconnect the negative battery cable from the battery.
2. Move the power take-off lever forward to the ON position.
3. Remove the boot from the button end of the power take-off switch (Fig. 38). Retain the boot for re-installation. Separate the switch wire connectors.



Figure 38

1. Power take-off switch

4. Remove the front jam nut securing the switch to the mounting bracket and remove the switch.
 5. Install a new power take off switch to the mounting bracket. Adjust the switch so it is depressed (13 mm) when the power take-off lever is moved to OFF. Tighten the jam nuts. Install the boot to the switch.
- Important** : Switch threads will be damaged if you overtighten the jam nuts.
6. Connect a continuity tester or ohm meter to the switch connector. With the power take-off lever in the ON position, the switch circuit should not have any continuity. If there is continuity, recheck the switch installation. If there is no continuity, go to the next step.
 7. Move the power take-off lever to the OFF position. When the power take-off lever is in its normal, released position, the power take off switch should have continuity. If there is no continuity, recheck switch installation. If there is no continuity, go to the next step.

8. Push the switch connectors together.
9. Connect the battery cable and install the instrument cover.

Correcting Power Take-Off Drive Belt Slippage

If the belt begins to slip because it has stretched or because of worn linkage:

1. Unlatch and remove instrument cover.
2. Move the power take off control lever to the ON position.
3. Measure the length of the power take-off spring between the flat washers (Fig. 52). There should be a spring length of 3- $\frac{3}{16}$ in. (81 mm).
4. To adjust, hold the head of the adjusting screw with a wrench (under the power take-off actuating arm) and turn the locknut (Fig. 39).
5. Move the power take-off lever to OFF and install the instrument cover.

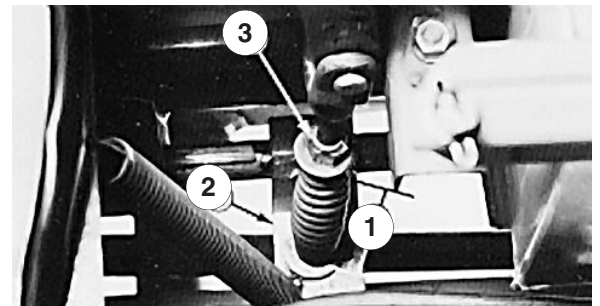

Figure 39

1. 3- $\frac{3}{16}$ in. (81 mm)
2. Power take-off actuating arm
3. Locknut

Adjusting the Parking Brake Interlock Switch

1. The gap between the parking brake shaft pivot paddle and the bottom of the interlock switch (Fig. 40) should be approximately $\frac{1}{16}$ " (the paddle must not contact switch).

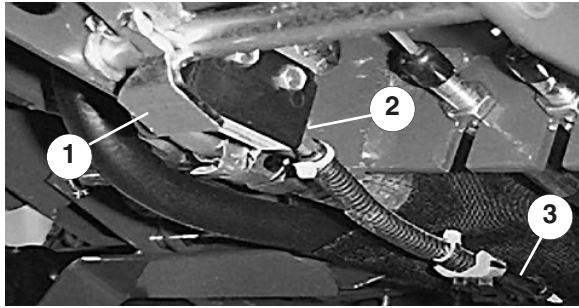

Figure 40

1. Parking brake interlock switch
2. Parking brake shaft pivot paddle
3. Wire harness connector

2. To adjust the gap, loosen the switch mounting screws, adjust the gap and tighten the screws.
3. Disconnect switch pigtail connector from wire harness.
4. Pull up on the parking brake lever and depress the brake pedal to lock the pedal into first click on latch.
5. Connect a continuity tester or ohm meter to the switch harness connector. With the parking brake engaged, the switch circuit should not have continuity. If there is continuity, recheck the switch or switch installation.

Adjusting the Tilt Steering Control

If the steering wheel tilt control lever must be adjusted, proceed as follows:

1. Remove the knob from the parking brake and the self-tapping screws from the steering column cover. Slide the cover up the steering shaft to expose the pivot bracket (Fig. 41).
2. Loosen the small nut, rotate pivot bracket until it tightens the large nut below (Fig. 41). Retighten the small nut.
3. Reinstall the steering column cover and the parking brake knob.

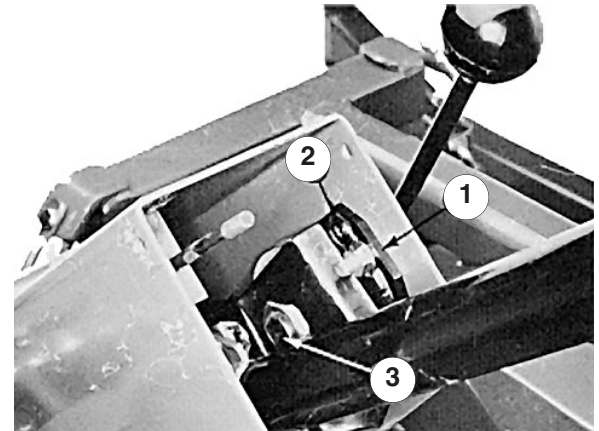

Figure 41

1. Pivot plate
2. Small nut
3. Large nut

Adjusting Rear Wheel Toe-In

The rear wheels should not toe-in or toe-out when they are adjusted correctly. To check the rear wheel toe-in, measure the center-to-center distance at wheel hub height, in front and in back of the rear tires. If the wheels toe-in or toe-out, an adjustment is required.

1. Turn the steering wheel so the rear wheels are straight ahead.
2. Loosen the jam nuts on both tie rods. Adjust both tie rods until center-to-center distance at the front and back of the rear wheels is the same (Fig. 42).
3. When rear wheels are adjusted correctly, tighten jam nuts against tie rods.

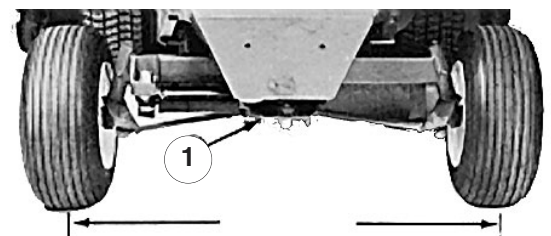

Figure 42

1. Steering plate

Adjusting the Rear Wheel Bearings

1. Jack up the rear of the machine until the wheel is off the floor. Use jack stands or block the machine to prevent it from accidentally falling.
2. Remove the dust cap from end of the wheel spindle. Also remove the cotter pin that keeps the slotted nut in place (Fig. 43).



Figure 43

1. Slotted nut

3. Rotate the wheel by hand and tighten the slotted nut until the bearing binds slightly. Then loosen the nut until the nearest slot and hole in the spindle line up. Install the cotter pin to keep the slotted nut in place.
4. Install the dust cap on the end of the wheel spindle.
5. Remove the jack stands and lower the machine to the floor.

Adjusting the Brakes

Adjust the service brakes when the turn pedals have more than 25 mm of “free travel”, or when the brakes don’t work effectively. Free travel is the distance the brake pedal moves before you feel braking resistance.

The brakes should only need adjustment after considerable use. These periodic adjustments can be performed where the brake cables connect to the brake pedal mount. When the cables are no longer adjustable, the star nut on the inside of the brake drum must be adjusted to move the brake shoes outward. However, the brake cables must be adjusted again to compensate for this adjustment.

1. To reduce free travel of the turn pedals—tighten the brakes—loosen the front nut on the threaded end of the brake cable (Fig. 44). Then tighten the rear nut to move the cable backward until the turn pedals have 13 to 25 mm of free travel. Tighten the front nut after brakes are adjusted correctly.

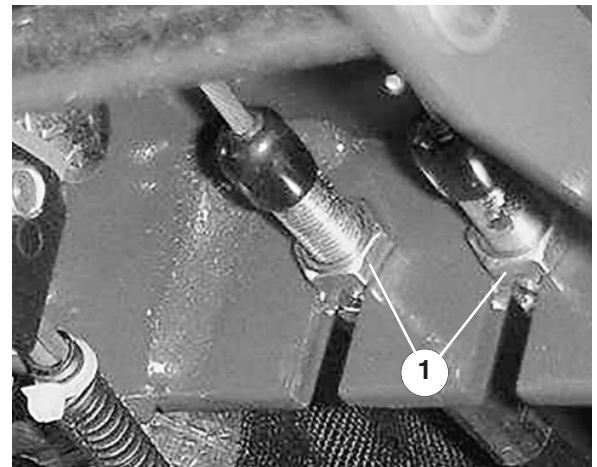

Figure 44

1. Jam nuts

2. When the brake cable cannot get free travel within 13 to 25 mm, the star nut inside the brake drum must be adjusted. However, before adjusting the star nut, loosen the brake cable nuts to prevent unnecessary strain on the cables.
3. Loosen the five wheel nuts holding the wheel and tire assembly on the wheel studs.
4. Jack up the machine until the front wheel is off the floor. Use jack stands or block the machine to prevent it from falling accidentally.
5. Remove the wheel nuts and slide the wheel and tire assembly off the studs. Rotate the brake drum until the adjusting slot is at the bottom and centered over the star nut that adjusts the brake

shoes (Fig. 45).



Figure 45

1. Slot

- Using a brake adjusting tool or screwdriver, turn the star nut (Fig. 45) down until the brake drum (Fig. 46) locks because of outward pressure of the brake shoes (Fig. 46).

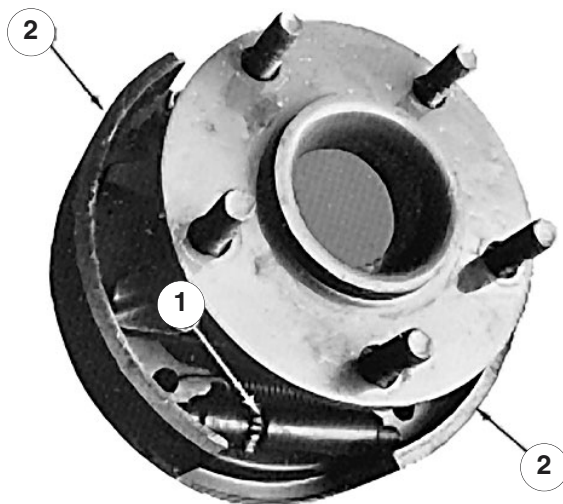

Figure 46

1. Star nut
2. Brake shoes

- Loosen the star nut about 12 to 15 notches or until the brake drum rotates freely.
- Install the wheel and tire assembly on studs with five wheel nuts. Tighten the nuts to 45–55 ft-lb (61–75 N•m).
- Remove the jack stands or blocking and lower the machine to the floor.

- Adjust the brake cables using step 1.

Adjusting the Lift Lever Latch

A lift lever latch that is positioned incorrectly can cause the lift lever to hold the spool in an actuated position when the implement is in the FLOAT position. This causes the oil in the hydraulic system to overheat. When the lift lever latch is adjusted correctly, the lift lever should just clear the rounded part of the latch as the lever is moved into the FLOAT position.

- Unscrew the ball from the lift lever.
- Remove the self-tapping screws and lift the cover off the lift lever to expose the latch.
- Loosen the two capscrews on the top of the lift lever latch (Fig. 47). Place the lever on rounded tip of the latch (Fig. 47), and slide the latch w/the lever forward until you feel stopping resistance. Then tighten the capscrews to lock the latch in place. Check for free operation of the lift lever by moving the lever from RAISE or TRANSPORT to FLOAT. The lift lever should just clear the rounded position of the latch as you move the lever into the FLOAT position.
- Slide the cover into place and install it with self-tapping screws. Screw the ball onto the lift lever.

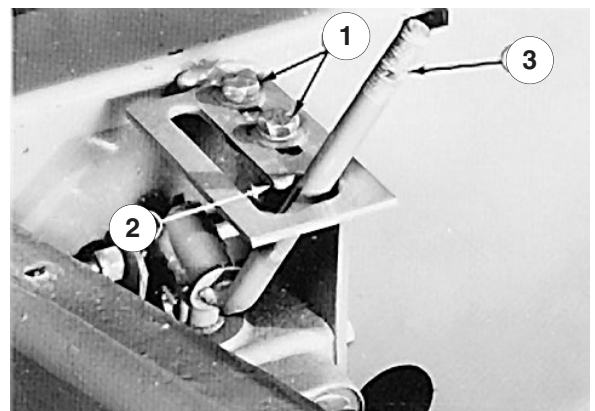

Figure 47

1. Capscrews
2. Rounded tab
3. Lift lever

Replacing the Hydraulic Oil Filter

The hydraulic oil filter keeps the hydraulic system relatively free of contaminants and must be serviced at regular intervals. **Initially, change the filter after first ten hours of engine operation, and thereafter, after every 125 hours of operation or yearly, whichever comes first.** Use Toro oil filter, Part No. 23-9740, as a replacement.

1. Clean the area where the hydraulic oil filter mounts. Remove the filter from the base (Fig. 48) and clean the filter mounting surface.
2. Lubricate the filter gasket with proper viscosity and type oil. Then fill the filter using the same oil.
3. Install the filter by hand until the gasket contacts the mounting head. Then rotate an additional $\frac{1}{2}$ turn.
4. Start the engine and check for hydraulic oil leaks. Allow the engine to run for about two minutes so any air in the system is purged (removed).
5. Shut the engine off and check the fluid level of hydraulic system; refer to *Checking the Hydraulic System Oil*, page 14.

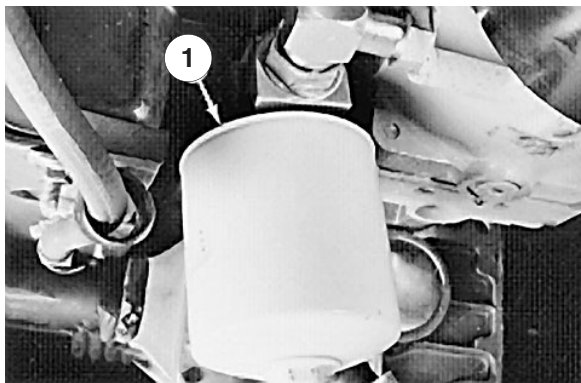

Figure 48

1. Hydraulic oil filter

Changing the Hydraulic System Oil

The hydraulic system oil must be changed after every 250 hours of operation or seasonally, whichever comes first. The hydraulic system is designed to operate on any high-quality detergent oil having the American Petroleum Institute—API—“service classification” SF/CC or CD. Oil viscosity—weight—must be selected according to anticipated ambient temperature for the season in which product will be used.

Expected Ambient Temperature	Recommended Viscosity and Type
(Extreme) over 32° C	SAE 30, Type SF/CC or CD engine oil
(Normal) 4–37° C	SAE 10W-30 or 10W-40, Type SF/CC or CD engine oil
(Cool) –1 to 10° C	SAE 5W-30, Type SF/CC or CD engine oil
(Winter) Below –1° C	Type “F” or “FA” ATF Automatic Transmission Fluid

Note: Do not mix engine oil and automatic transmission fluid or hydraulic system component damage may result. When changing fluids, also change transmission filter. **Do not use Dexron II ATF.**

Note: Fluid to operate the power steering is supplied by the hydraulic system transmission charge pump. Cold weather start-up may result in “stiff” steering until the hydraulic system has warmed up. Using proper weight hydraulic oil in system minimizes this condition.

The transmission and axle housing are shipped from the factory with approximately 5 quarts (4.7 l) of SAE 10W-30 engine oil. However, check the transmission oil level before you first start the engine and daily thereafter.

1. Start the engine, park the machine on a level surface, lower the implement to the floor, set the parking brake, and shut the engine off. Block the two rear wheels.
2. Jack up both sides of the front axle and support it

with jack stands.

3. Clean the area around the hydraulic oil filter and remove the filter.
4. Remove drain plug from the fitting between axle housing and oil filter and let the oil flow into a drain pan (Fig. 49).

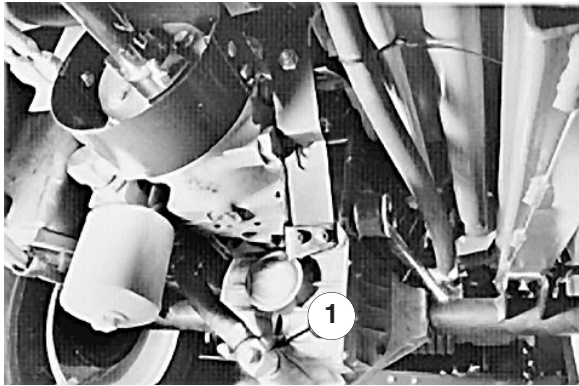

Figure 49

1. Drain plug

5. Install a new filter; refer to steps 1–2 in *Replacing Hydraulic Oil Filter*, page 14, for proper procedures.
6. Install the drain plug in the fitting between the axle housing and oil filter (Fig. 49).
7. Remove the dipstick from the axle filler tube (Fig. 50) and fill the axle to proper level with correct type and viscosity oil recommended for expected ambient temperature conditions; refer to table above.
8. Start and run the engine at idle speed for about two minutes and turn the steering wheel lock to lock to purge air trapped in the system. Shut the engine off.
9. Let the machine sit for two additional minutes, then remove the dipstick and check the oil level in axle (Fig. 50). If the level is low, add oil until the level matches the groove in the dipstick (Fig. 50). If the level is too high, remove the drain plug (Fig. 49) and drain oil until the oil level matches the groove in the dipstick.

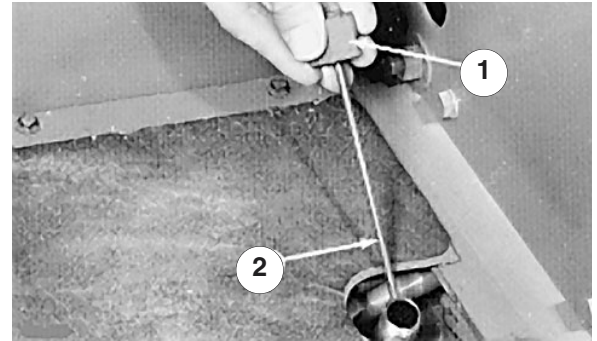

Figure 50

1. Dipstick
2. Groove

Fuses

There are 3 fuses in the machine's electrical system, located below control panel.



Figure 51

1. Fuse block

Servicing the Battery

!

WARNING

!

Battery posts, terminals, and related accessories contain lead and lead compounds, chemicals known to the State of California to cause cancer and reproductive harm. Wash your hands after handling.

Important Before welding on the machine, disconnect the ground cable from the battery to prevent damage to the electrical system.

Note: Check battery condition weekly or after every 50 hours of operation. Keep the terminals and battery case clean because a dirty battery will discharge slowly. To clean the battery, wash the entire case with solution of baking soda and water. Rinse with clear water. Coat the battery posts and cable connectors

with Grafo 112X (skin-over) grease (Toro Part No. 505-47) or petroleum jelly to prevent corrosion.

Seasonal Storage Traction Unit

1. Thoroughly clean the traction unit, cutting unit and the engine, paying special attention to these areas:
 - Radiator screen
 - Underneath the cutting unit
 - Under the cutting unit belt covers
 - Counterbalance springs
 - Power take-off shaft assembly
 - All grease fittings and pivot points
2. Check the tire pressure. Inflate all traction unit tires to 21 psi (145 kPa).
3. Remove, sharpen, and balance the cutting unit's blades. Reinstall the blades and torque the blade fasteners to specifications.
4. Check all fasteners for looseness; tighten as necessary.
5. Grease or oil all grease fittings and pivot points. Wipe up any excess lubricant.
6. Ensure that the power take-off belt remains in the disengaged position so that the power take-off belt does not take a "set."
7. Lightly sand and use touch-up paint on painted areas that are scratched, chipped, or rusted. Repair any dents in the metal body.
8. Service the battery and cables as follows:
 - A. Remove the battery terminals from the battery posts.
 - B. Clean the battery, terminals, and posts with a wire brush and baking soda solution.

- C. Coat the cable terminals and battery posts with Grafo 112X skin-over grease (Toro Part No. 505-47) or petroleum jelly to prevent corrosion.
- D. Slowly recharge the battery every 60 days for 24 hours to prevent lead sulfation of the battery.

Engine

1. Drain the engine oil from the oil pan and replace the drain plug.
2. Remove and discard the oil filter. Install a new oil filter.
3. Remove fill cap and add 4 quarts (3.8 l) of SAE 10W-30 CD, CE, CF, CF-4 or CG-4 classification oil until the level reaches FULL mark on the dipstick. DO NOT OVERFILL.
4. Start the engine and run at idle speed for approximately two minutes.
5. Stop the engine.
6. Thoroughly drain all fuel from the fuel tank, lines, fuel pump filter, and the fuel filter/water separator assembly.
7. Flush the fuel tank with fresh, clean diesel fuel.
8. Secure all fuel system fittings.
9. Thoroughly clean and service the air cleaner assembly.
10. Seal the air cleaner inlet and the exhaust outlet with weatherproof tape.
11. Check anti-freeze protection and add as needed for expected minimum temperature in your area.

