



MODEL NO. 04052TE—200000001 & UP

**OPERATOR'S  
MANUAL**

**GREENSMASTER® 1000**





# Safety

## Training

1. Read the instructions carefully. Be familiar with the controls and the proper use of the equipment.
  2. Never allow children or people unfamiliar with these instructions to use the lawn mower. Local regulations may restrict the age of the operator.
  3. Never mow while people, especially children, or pets are nearby.
  4. Keep in mind that the operator or user is responsible for accidents or hazards occurring to other people or their property.
  5. Do not carry passengers.
  6. All drivers should seek and obtain professional and practical instruction. Such instruction should emphasize:
    - the need for care and concentration when working with ride-on machines;
    - control of a ride-on machine sliding on a slope will not be regained by the application of the brake. The main reasons for loss of control are:
      - insufficient wheel grip;
      - being driven too fast;
      - inadequate braking;
      - the type of machine is unsuitable for its task;
      - lack of awareness of the effects of ground conditions, especially slopes;
      - incorrect hitching and load distribution.
2. Thoroughly inspect the area where the equipment is to be used and remove all objects which may be thrown by the machine.
  3. **WARNING—Petrol is highly flammable.**
    - Store fuel in containers specifically designed for this purpose.
    - Refuel outdoors only and do not smoke while refueling.
    - Add fuel before starting the engine. Never remove the cap of the fuel tank or add petrol while the engine is running or when the engine is hot.
    - If petrol is spilled, do not attempt to start the engine but move the machine away from the area of spillage and avoid creating any source of ignition until petrol vapors have dissipated.
    - Replace all fuel tanks and container caps securely.
  4. Replace faulty silencers.

## Operation

## Preparation

1. While mowing, always wear substantial footwear and long trousers. Do not operate the equipment when barefoot or wearing open sandals.
1. Do not operate the engine in a confined space where dangerous carbon monoxide fumes can collect.
  2. Mow only in daylight or in good artificial light.
  3. Before attempting to start the engine, disengage all blade attachment clutches and shift into neutral.
  4. Do not use on slopes of more than:
    - Never mow side hills over 5°
    - Never mow uphill over 10°
    - Never mow downhill over 15°
  5. Remember there is no such thing as a “safe” slope. Travel on grass slopes requires particular care. To guard against overturning:
    - do not stop or start suddenly when going up or downhill;

- engage the clutch slowly, and always keep the machine in gear, especially when travelling downhill;
  - machine speeds should be kept low on slopes and during tight turns;
  - stay alert for bumps and hollows and other hidden hazards;
  - never mow across the face of the slope, unless the lawn mower is designed for this purpose.
- 6.** Use care when pulling loads or using heavy equipment.
- Use only approved drawbar hitch points.
  - Limit loads to those you can safely control.
  - Do not turn sharply. Use care when reversing.
  - Use counterweight(s) or wheel weights when suggested in the instruction handbook.
- 7.** Watch out for traffic when crossing or near roadways.
- 8.** Stop the blades rotating before crossing surfaces other than grass.
- 9.** When using any attachments, never direct discharge of material toward bystanders nor allow anyone near the machine while in operation .
- 10.** Never operate the lawn mower with defective guards, shields or without safety protective devices in place.
- 11.** Do not change the engine governor settings or overspeed the engine. Operating the engine at excessive speeds may increase the hazard of personal injury.
- 12.** Before leaving the operator's position:
- disengage the power take-off and lower the attachments;
  - change into neutral and set the parking brake;
  - stop the engine and remove the key.
- 13.** Disengage the drive to attachments when transporting or not in use.
- 14.** Stop the engine and disengage the drive to the attachment
- before refueling;
  - before removing the grass catcher;
  - before making height adjustments unless the adjustment can be made from the operator's position.
  - before clearing blockages;
  - before checking, cleaning or working on the lawnmower;
  - after striking a foreign object. Inspect the lawnmower for damage and make repairs before restarting and operating the equipment.
- 15.** Reduce the throttle setting during engine runout and, if the engine is provided with a shutoff valve, turn the fuel off at the conclusion of mowing.

## **Maintenance and Storage**

- 1.** Keep all nuts, bolts and screws tight to be sure the equipment is in safe working condition.
- 2.** Never store the equipment with petrol in the tank inside a building where fumes may reach an open flame or spark.
- 3.** Allow the engine to cool before storing in any enclosure.
- 4.** To reduce the fire hazard, keep the engine, silencer, battery compartment and petrol storage area free of grass, leaves, or excessive grease.
- 5.** Check the grass catcher frequently for wear or deterioration.
- 6.** Replace worn or damaged parts for safety.
- 7.** If the fuel tank has to be drained, this should be done outdoors.

8. Be careful during adjustment of the machine to prevent entrapment of the fingers between moving blades and fixed parts of the machine.
9. On multi-bladed machines, take care as rotating one blade can cause other blades to rotate.
10. When the machine is to be parked, stored or left unattended, lower the cutting means unless a positive mechanical lock is used.





### **Sound Pressure Level**



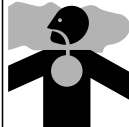

This unit has an equivalent continuous A-weighted sound pressure at the operator ear of: 83 dB(A), based on measurements of identical machines per 84/538/EEC.

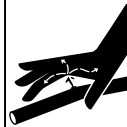

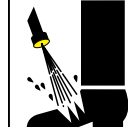
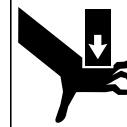
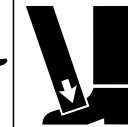

### **Vibration Level**

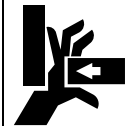
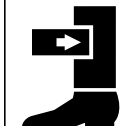
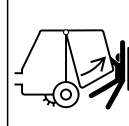
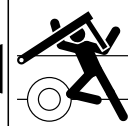
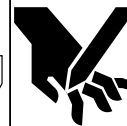

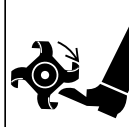

This unit has a hand-arm vibration level of 10.05 m/s<sup>2</sup>, based on measurements of identical machines per ISO 5349 procedures.

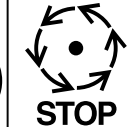
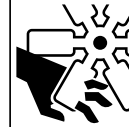
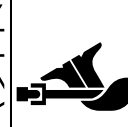



# Symbol Glossary

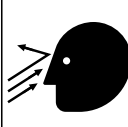
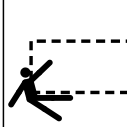
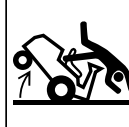

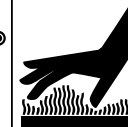

|                                                                                   |                                                                                   |                                                                                   |                                                                                   |                                                                                   |                                                                                    |                                                                                     |                                                                                     |
|-----------------------------------------------------------------------------------|-----------------------------------------------------------------------------------|-----------------------------------------------------------------------------------|-----------------------------------------------------------------------------------|-----------------------------------------------------------------------------------|------------------------------------------------------------------------------------|-------------------------------------------------------------------------------------|-------------------------------------------------------------------------------------|
|  |  |  |  |  |  |  |  |
| Caustic liquids, chemical burns to fingers or hand                                | Poisonous fumes or toxic gases, asphyxiation                                      | Electrical shock, electrocution                                                   | High pressure fluid, injection into body                                          | High pressure spray, erosion of flesh                                             | High pressure spray, erosion of flesh                                              | Crushing of fingers or hand, force applied from above                               | Crushing of toes or foot, force applied from above                                  |

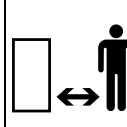
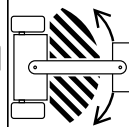
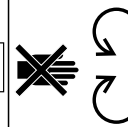
|                                                                                   |                                                                                   |                                                                                   |                                                                                   |                                                                                   |                                                                                    |                                                                                     |                                                                                     |
|-----------------------------------------------------------------------------------|-----------------------------------------------------------------------------------|-----------------------------------------------------------------------------------|-----------------------------------------------------------------------------------|-----------------------------------------------------------------------------------|------------------------------------------------------------------------------------|-------------------------------------------------------------------------------------|-------------------------------------------------------------------------------------|
|  |  |  |  |  |  |  |  |
| Crushing of whole body, applied from above                                        | Crushing of torso, force applied from side                                        | Crushing of fingers or hand, force applied from side                              | Crushing of leg, force applied from side                                          | Crushing of whole body                                                            | Crushing of head, torso and arms                                                   | Cutting of fingers or hand                                                          | Cutting of foot                                                                     |

|                                                                                    |                                                                                    |                                                                                    |                                                                                    |                                                                                    |                                                                                     |                                                                                      |
|------------------------------------------------------------------------------------|------------------------------------------------------------------------------------|------------------------------------------------------------------------------------|------------------------------------------------------------------------------------|------------------------------------------------------------------------------------|-------------------------------------------------------------------------------------|--------------------------------------------------------------------------------------|
|  |  |  |  |  |  |  |
| Cutting or entanglement of foot, rotating auger                                    | Severing of foot, rotating knives                                                  | Severing of fingers or hand, impeller blade                                        | Wait until all machine components have completely stopped before touching them     | Severing of fingers or hand, engine fan                                            | Whole body entanglement, implement input drive line                                 | Fingers or hand entanglement, chain drive                                            |

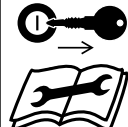
|                                                                                     |                                                                                     |                                                                                     |                                                                                     |                                                                                     |                                                                                      |                                                                                       |                                                                                       |
|-------------------------------------------------------------------------------------|-------------------------------------------------------------------------------------|-------------------------------------------------------------------------------------|-------------------------------------------------------------------------------------|-------------------------------------------------------------------------------------|--------------------------------------------------------------------------------------|---------------------------------------------------------------------------------------|---------------------------------------------------------------------------------------|
|  |  |  |  |  |  |  |  |
| Hand & arm entanglement, belt drive                                                 | Thrown or flying objects, whole body exposure                                       | Thrown or flying objects, face exposure                                             | Runover/backover, (relevant machine to appear in dashed box)                        | Machine tipping, riding mower                                                       | Machine rollover, ROPS (relevant machine to appear in dashed box)                    | Stored energy hazard, kickback or upward motion                                       | Hot surfaces, burns to fingers or hands                                               |

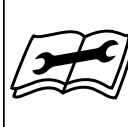
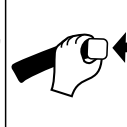
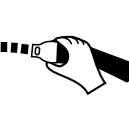
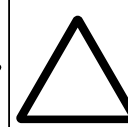
|                                                                                     |                                                                                     |                                                                                     |                                                                                     |                                                                                     |                                                                                      |                                                                                       |                                                                                       |
|-------------------------------------------------------------------------------------|-------------------------------------------------------------------------------------|-------------------------------------------------------------------------------------|-------------------------------------------------------------------------------------|-------------------------------------------------------------------------------------|--------------------------------------------------------------------------------------|---------------------------------------------------------------------------------------|---------------------------------------------------------------------------------------|
|  |  |  |  |  |  |  |  |
| Explosion                                                                           | Fire or open flame                                                                  | Secure lifting cylinder with locking device before getting in hazardous area        | Stay a safe distance from the machine                                               | Stay clear of articulation area while engine is running                             | Do not open or remove safety shields while engine is running                         | Do not step on loading platform if PTO is connected to tractor & engine is running    | Do not step                                                                           |

|                                                                                     |                                                                                                        |                                                                                     |                                                                                     |                                                                                     |                                                                                      |                                                                                       |
|-------------------------------------------------------------------------------------|--------------------------------------------------------------------------------------------------------|-------------------------------------------------------------------------------------|-------------------------------------------------------------------------------------|-------------------------------------------------------------------------------------|--------------------------------------------------------------------------------------|---------------------------------------------------------------------------------------|
|  |                     |  |  |  |  |  |
| Shut off engine & remove key before performing maintenance or repair work           | Riding on this machine is allowed only on a passenger seat & only if the driver's view is not hindered | Consult technical manual for proper service procedures                              | Fasten seat belts                                                                   | Safety alert triangle                                                               | outline safety alert symbol                                                          | Read operator's manual                                                                |

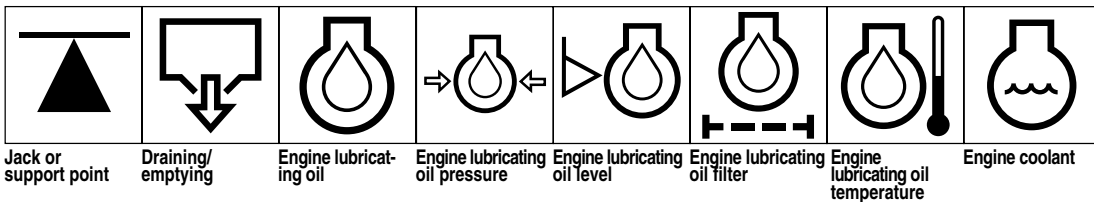
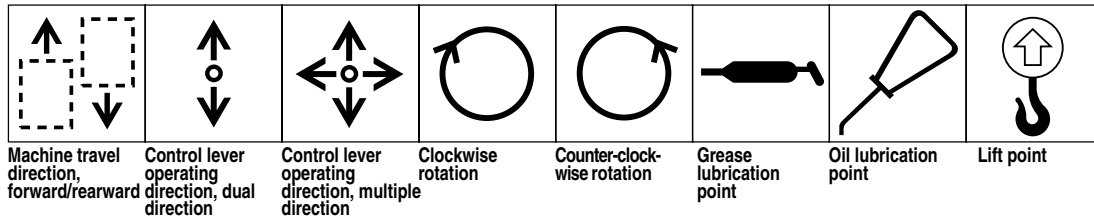
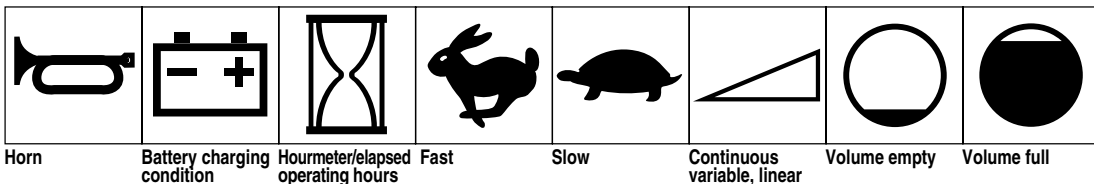
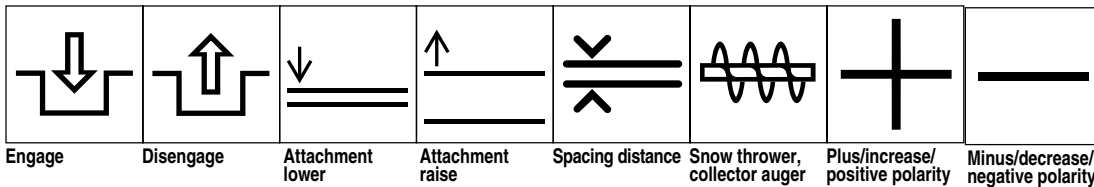
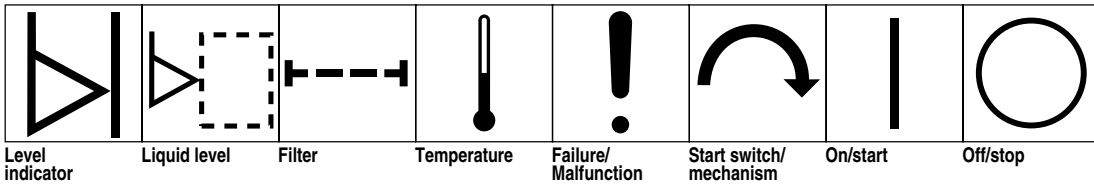
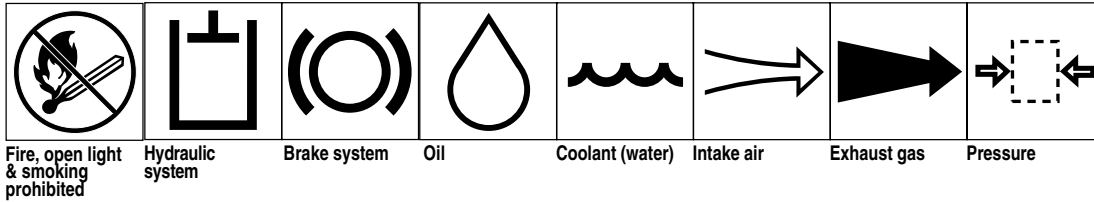

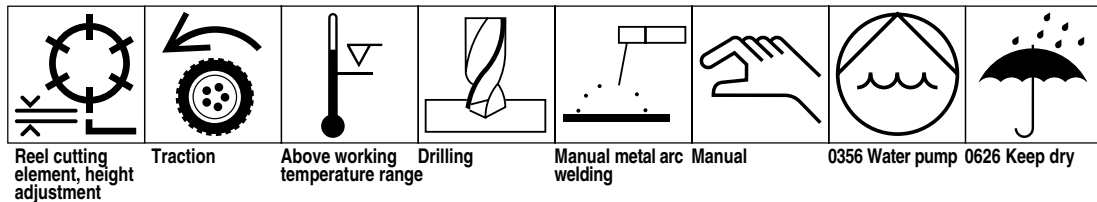
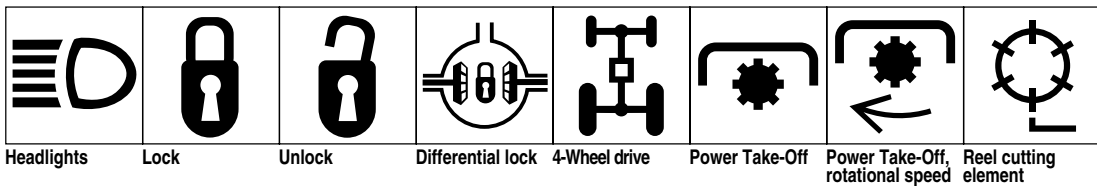
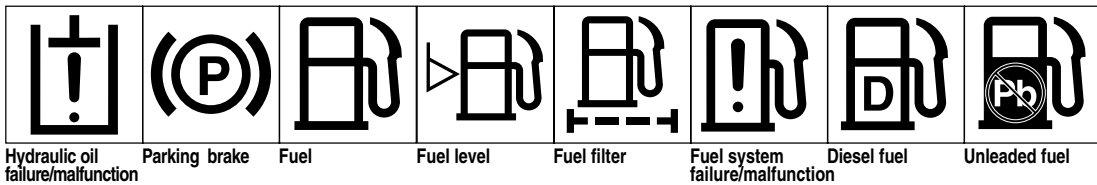
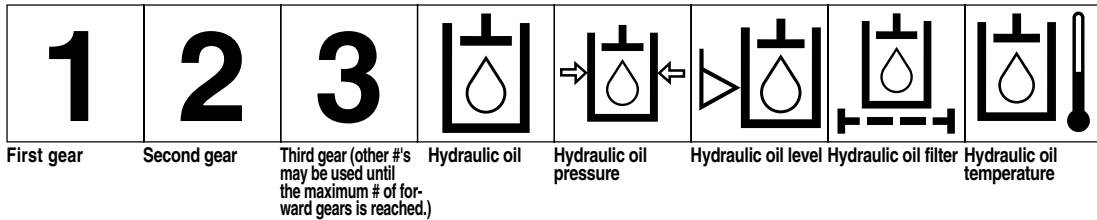
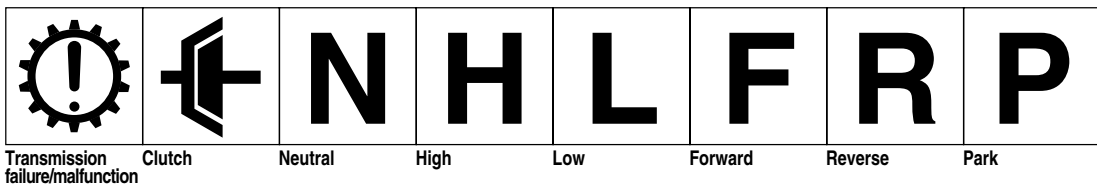
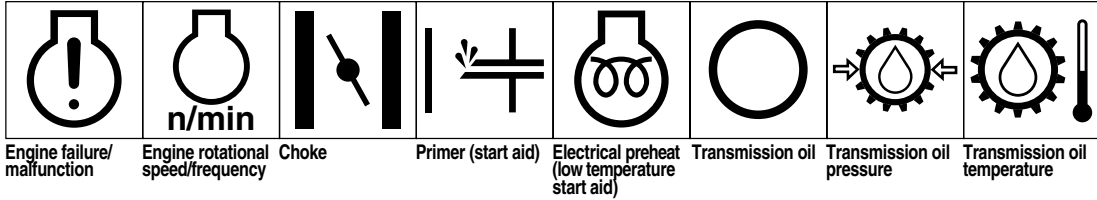
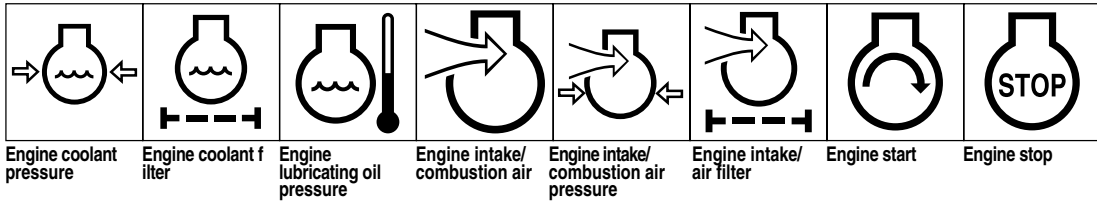

# Specifications

**Engine:** Kawasaki, air cooled, overhead valve, 4 cycle, 2.76 kW (3.7 hp), 2.36" x 1.73" bore and stroke, 7.57 cu. in. (124 cc) displacement, 8.4:1 compression ratio, 14.9 Nm (11 ft. lbs.) @ 1400 rpm. Electronic ignition, maximum noise suppression muffler. 2.5 l (2.64 quart) fuel tank capacity.

**Traction Drive:** Engine to countershaft drive: two "A" section V belts. Countershaft to differential drive: 5mm pitch timing belt. Differential to drum drive: 8mm pitch timing belt.

**Differential:** Peerless Series 100.

**Transport Clutch:** Belt idler

**Brake:** Band drum

**Optional Transport Tires:** Quick detachable, 3.00/3.25 x 6, 32.5 tread width.

**Traction Drum:** Dual cast aluminum, 19 cm (7.5") diameter.

**Controls:** Engine has recoil starter, ON/OFF switch, and choke. Handle has throttle lever, traction engage lever and service/ park brake lever. The mower has reel drive engage lever. Safety devices: neutral interlock system.

**Handle:** Loop style, 2.5cm (1") diameter.

**Reel Construction:** 12.7cm (5") diameter, 11 carbon steel blades welded to 5 stamped steel spiders.

**Width of Cut:** 53.3 cm (21")

**Height of Cut Range:** 2mm–12.25 mm (5/64" to 1/2")

**Clip:** 0.16"

**Reel Clutch:** Jaw Type.

**Bedknife and bedbar:** Single-edged, high-carbon steel bedknife, hardened to Rc 48–55. Fastened to machined, cast iron bedbar. Tournament bedknife (Part No. 93-4263), standard.

**Grass Basket:** Molded polyethylene.

**Dimensions:**

|         |                |
|---------|----------------|
| Width:  | 91.4 cm (36")  |
| Height: | 119.4 cm (47") |
| Length: | 149.9 cm (59") |

**Dry Weight:** 208 lbs. with basket and Wiehle roller, without wheels or grooming reel.

# Preparation Before Operating

## Add Engine Oil

Initially, the crankcase must be filled with 47 cl (16 ounces) of proper viscosity oil (See chart below). Use any high-quality detergent oil having the American Petroleum Institute (API) “service classification”—SG SH, or SJ.

| Temperature   | Oil Viscosity   |
|---------------|-----------------|
| 10°C or below | SAE 10W30       |
| 10°C to 35°C  | SAE 10W30 or 30 |
| Above 35°C    | SAE 40          |

1. Position the mower so the engine is level and clean around the oil level gauge (Fig. 1).

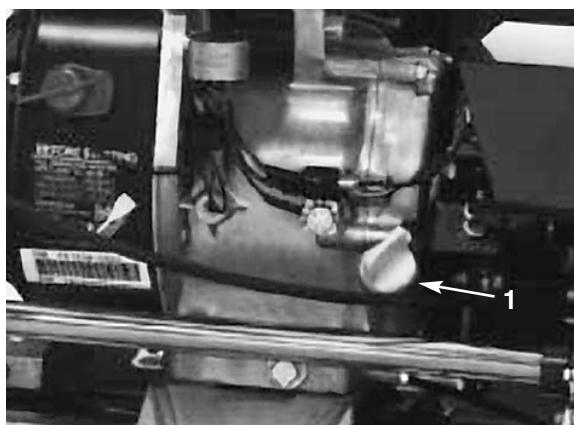

Figure 1

1. Oil level gauge

2. Remove the gauge by turning it counterclockwise.
3. Wipe the gauge clean and insert it into the filler port. Then remove it and check the level of oil. Do not screw the gauge into the port. If the level is low, add only enough oil to raise the level to the filler opening.

**Note:** We recommend that the oil level be checked each time the mower is used or after every 5 operating hours. Initially, change the oil after the first 20 hours of operation; thereafter, change the oil after every 50 hours of operation. **More frequent oil changes are required in dusty or dirty conditions.**

## Fill The Fuel Tank

**NOTE:** NEVER USE METHANOL, GASOLINE CONTAINING METHANOL, GASOLINE CONTAINING MORE THAN 10% ETHANOL, GASOLINE ADDITIVES, PREMIUM GASOLINE OR WHITE GAS BECAUSE FUEL SYSTEM DAMAGE COULD RESULT.

! **DANGER** !

Because fuel is flammable, caution must be used when storing or handling it. Do not fill the fuel tank while the engine is running, hot or when the machine is in an enclosed area. Vapors may build up and be ignited by a spark or flame source many feet away. **DO NOT SMOKE** while filling the fuel tank to prevent the possibility of an explosion. Always fill the fuel tank outside and wipe up any spilled fuel before starting the engine. Use a funnel or spout to prevent spilling, and fill the tank no higher than to the bottom of the filler screen. **DO NOT OVER FILL.**

Store fuel in a clean safety approved container and keep the cap on the container. Keep fuel in a cool, well-ventilated place; never in an enclosed area such as a hot storage shed. To assure volatility, do not buy more than a 30-day supply of gasoline, or a 6-month supply of diesel fuel.

Gasoline is a fuel for internal combustion engines; therefore, do not use it for any other purpose.

Since many children like the smell of gasoline, keep it out of their reach because the fumes are explosive and dangerous to inhale.

1. Clean around the fuel tank cap and remove the cap from tank (Fig. 2). Using unleaded gasoline, fill the fuel tank no higher than to the bottom of the filter screen. **DO NOT OVER FILL.**



Figure 2

1. Fuel tank cap

2. Install the fuel tank cap and wipe up any spilled gasoline.

## Leveling The Rear Drum To The Reel

1. Position the machine on a flat, level surface, preferably a precision steel plate. Place a 6mm x 25mm flat steel strip, 61 cm long, under the reel blades and against the front edge of the bed knife to prevent the bedbar from resting on the work surface.
2. Raise the front roller so that only the rear drum and the reel are on the surface.
3. Firmly press down on the machine above the reel so all reel blades contact the steel strip.
4. While pressing down on the reel, slide a feeler gauge under one end of the drum, then check the other end of the drum. If there is a gap between the drum and the work surface, greater than 0.25mm on either end, an adjustment to the drum is required; go to step 5. If the gap is less than 0.25mm no adjustment is required.
5. Remove the rear belt cover from the right side of the machine.
6. Rotate the drive pulley until the holes align with the (4) roller bearing flange screws (Fig. 3).

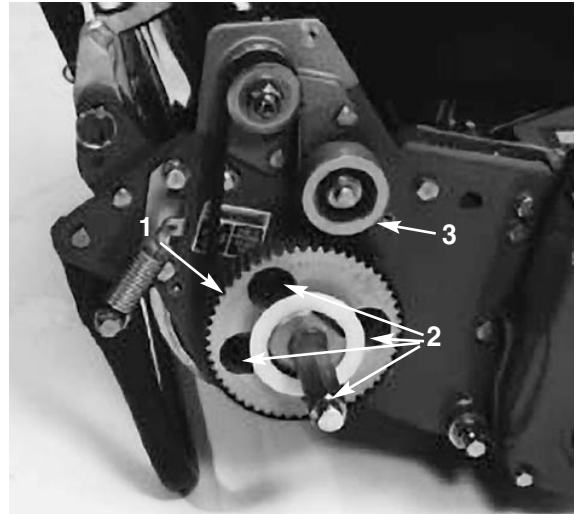

Figure 3.

1. Drive pulley
2. Four holes
3. Idler pulley

7. Loosen the four roller bearing screws and the screw securing the idler pulley. Raise or lower the right side of the roller assembly until the gap is reduced to less than 0.25mm (0.01"). Tighten the roller-bearing screws. Adjust belt tension and tighten idler pulley mounting screw (Fig. 3).

## Adjust The Bedknife To The Reel

Bedknife-to-reel adjustment is done by loosening or tightening the bedknife adjusting screws, located on top of the mower.

1. Position the machine on a flat, level work surface. Make sure the reel contact is removed by loosening jam nuts on the bedknife adjusting screws and rotating the adjusting screws counterclockwise (Fig. 4).
2. Tilt the mower back on the handle to expose the bedknife and reel.

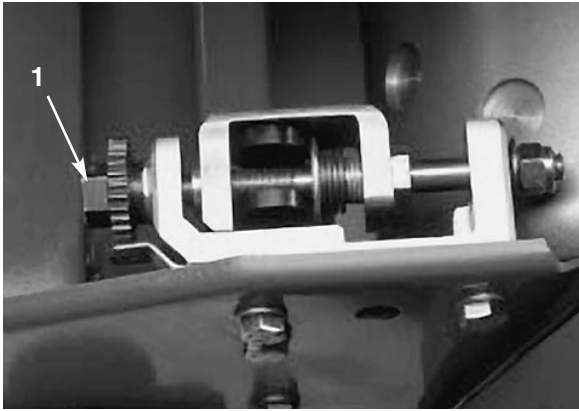

Figure 4

1. Bedknife adjusting screw

3. On one end of the front side of the reel, insert a long strip of newspaper between the reel and the bedknife (Fig. 5). While slowly rotating the reel forward, tighten the bedknife adjusting screw (on same end of the reel), one flat at a time, until the paper is pinched lightly when inserted from the front, parallel to the bedknife, which results in a slight drag when the paper is pulled (Fig. 4).



Figure 5

**Note:** Each time the adjusting screw is rotated one click, the bedknife moves .0018mm closer to the reel. **DO NOT OVERTIGHTEN THE ADJUSTING SCREW.**

4. Check for light contact at the other end of the reel using the paper and adjust as required.
5. After adjustment, check to see if the reel can pinch paper when it is inserted from the front and cut paper when inserted at a right angle to the bedknife (Fig. 5). It should be possible to cut paper with minimum contact between the bedknife and the reel blades. Should excessive reel drag be evident, it will be either necessary

to backlap or regrind the cutting unit to achieve the sharp edges needed for precision cutting (see Toro reel sharpening manual).

## Adjust The Height Of Cut

1. Verify that the rear roller is level and that the bedknife-to-reel contact is correct. Tip the mower back on its handle to expose the front and rear rollers and the bedknife.
2. Loosen the locknuts securing the height-of-cut arms to the height-of-cut brackets (Fig. 6).

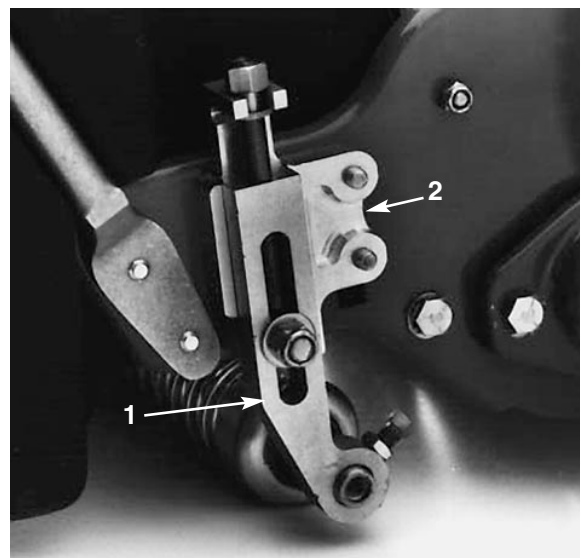

Figure 6

1. Height-of-cut arm  
2. Height-of-cut bracket

3. Loosen the nut on the gauge bar (Fig. 7) and set the adjusting screw to desired height of cut. The distance between the bottom of the screw head and the face of the bar is height of cut.

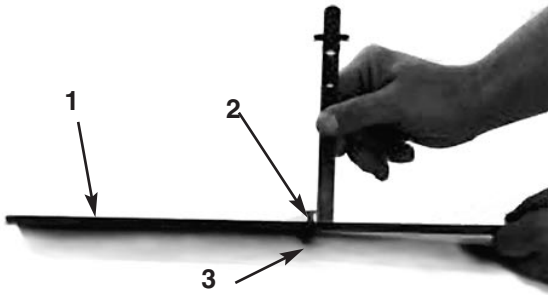

Figure 7

1. Gauge bar
2. Height adjusting screw
3. Nut

4. Hook the screw head on the cutting edge of the bedknife and rest the rear end of the bar on the rear roller (Fig. 8).
5. Rotate the adjusting knob until the roller contacts the front of the gauge bar. Adjust both ends of the roller until the entire roller is parallel to the bedknife.

**IMPORTANT:** When set properly, the rear and front rollers will contact the gauge bar and the screw will be snug against the bedknife. This assures height of cut is identical at both ends of the bedknife.

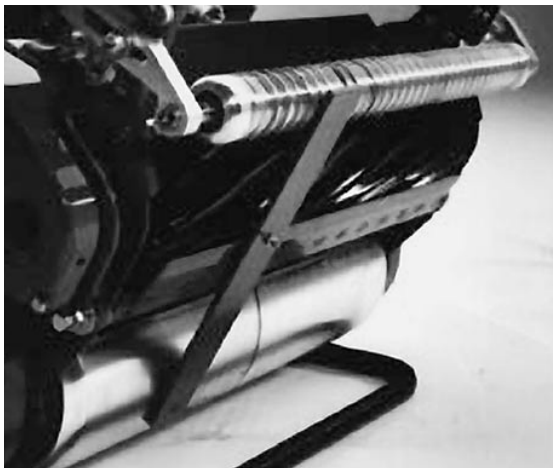

Figure 8

6. Tighten the nuts to lock adjustment.

**IMPORTANT:** To avoid scalping on undulating turf, make sure the roller supports are positioned rearward (roller closer to the reel).

**Note:** The front roller can be put in three different positions (Fig. 9) depending on the application and your needs.

- Use the front position when a groomer is installed.
- Use the middle position without a groomer.
- Use the third position in extremely undulating turf conditions.

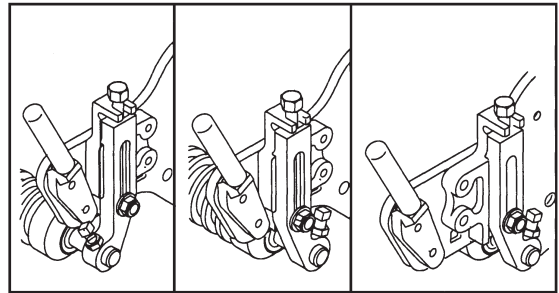

Figure 9

## Adjusting Grass Shield Height

Adjust the shield to assure proper grass clipping discharge into the basket.

1. Measure the distance from the top of the front support rod to the front lip of the shield at each end of the cutting unit (Fig. 10).



Figure 10

1. Support rod
2. Shield

2. The height of the shield from the support rod for normal cutting conditions should be 10 cm (4 inches). Loosen the capscrews and nuts securing each end of the shield to the side plate, adjust the shield to its correct height and tighten the fasteners.

**Note:** The shield can be lowered for drier conditions (clippings fly over the top of the basket) or raised to allow for heavy wet grass conditions (clippings build up on the rear of the basket).

## Adjusting The Cut-Off Bar

Adjust the cut-off bar to assure clippings are cleanly discharged from the reel area:

1. Loosen the screws securing the top bar (Fig. 11) to the cutting unit. Insert a .060 inch feeler gauge between the top of the reel and the bar and tighten the screws. Assure the bar and the reel are equal distance apart across the entire reel.

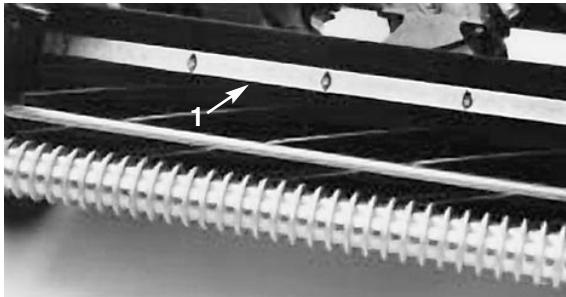

Figure 11

1. Support rod

**Note:** The bar is adjustable to compensate for changes in turf conditions. The bar should be adjusted closer to the reel when turf is extremely wet. By contrast, adjust the bar further away from the reel when turf conditions are dry.

The bar should be parallel to the reel to assure optimum performance and should be adjusted whenever shield height is adjusted or whenever the reel is sharpened on a reel grinder.

## Install The Grass Basket

1. Grasp the basket by the top rear lip and slide it onto the basket mounting rods (Fig. 12).



Figure 12

1. Grass basket

## Check Interlock Switch Operation

1. Place the traction lever into the ENGAGE position and the engine controls in STARTING position.
2. Try to start the engine. The engine should not start. If it does, the interlock switch needs service. Correct the problem before operating. Refer to *Adjusting the Interlock Switch*.

# Controls

**Traction Engagement Lever** (Fig. 13)—Located on the front right side of the control panel. The lever has two positions: NEUTRAL and FORWARD. Pushing the lever forward engages the traction drive.

**Operator Presence Control (Optional)** (Fig. 13)—Located on the rear of the handle. Push the control lever forward to engage the traction drive. The lever must be engaged before engaging the traction engagement level or the engine will stop.

**Service/Park Brake** (Fig. 13)—Located on the left front side of control panel. Use the brake to slow or stop the machine. The brake can also be used as a parking brake. Pulling the lever back over the center will set the parking brake.

**Throttle Control** (Fig. 13)—Located on the rear right side of control panel. The lever connects to and operates the throttle linkage to the carburetor. Engine speed can be varied from 1600 rpm to 3600 rpm.



Fig. 13

1. Throttle control
2. Traction engagement lever
3. Service/park brake
4. Operator presence control (optional)

**Reel Drive Engagement Lever** (Fig. 14)—Located on the right front corner of the machine. The lever has two positions: ENGAGE and DISENGAGE. Pull up on the lever to engage the reel or push down on the lever to disengage the reel.

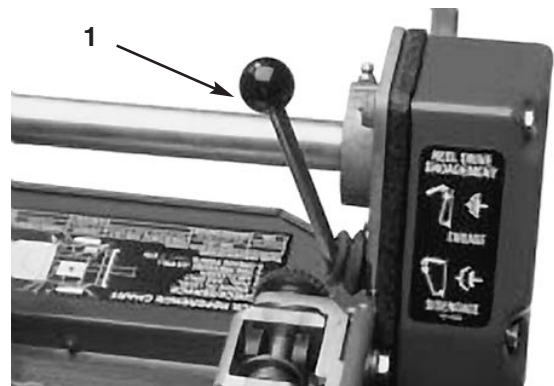

Fig. 14

1. Reel drive engagement lever

**Choke Lever** (Fig. 15)—Located on the left front of the engine. The lever has two positions: RUN and CHOKE. Move the lever to CHOKE when starting a cold engine. After the engine starts, move the lever to RUN.

**Fuel Shut-off Valve** (Fig. 15)—Located on the left front of the engine. The valve has two positions: CLOSED and OPEN. Move the lever to CLOSED when storing or transporting the machine. Move the valve to OPEN before starting the engine.



Fig. 15

1. Choke lever
2. Fuel shut off valve

**Recoil Starter** (Fig. 16)—Pull the recoil starter handle to start the engine.

**Kick Stand** (Fig. 16)—Located at the rear of the machine, the kickstand is used to raise the rear of the machine for installation or removal of transport wheels.

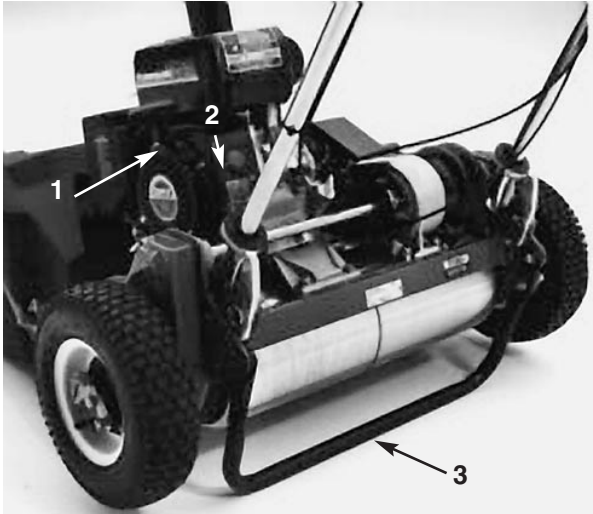

Fig. 16

1. Recoil starter
2. On/Off switch
3. Kickstand

# Operating Instructions

## Starting And Stopping

**Note:** Make sure the spark plug wire is installed on the spark plug.

1. Make sure the traction (Fig. 13 ) and reel drive (Fig. 13) levers are in the DISENGAGED position.

**Note:** The engine will not start if the traction lever is in the engaged position.

2. Open the fuel shut-off valve on the engine (Fig. 15).
3. Move the ON/OFF switch (Fig. 16) to ON.
4. Move the throttle control (Fig. 13) to FAST.
5. Move the choke lever (Fig. 15) to the half-open position when starting a cold engine. The choke may not be required when starting a warm engine.
6. Pull the recoil starter handle out until positive engagement results, then pull vigorously to start the engine. Close the choke as the engine warms up.

**Note:** Do not pull the recoil rope to its limit or let go of the starter handle when pulling the rope because the rope may break or the recoil assembly may be damaged.

7. To stop the engine during operation, move the traction and reel drive controls to DISENGAGED, the throttle control to SLOW and the ON/OFF switch to OFF.
8. Before storing the machine, pull the spark plug wire off the spark plug to prevent accidental starting.
9. Close the fuel shut-off valve before storing or transporting the mower in a vehicle.

## Transport Operation

1. Push the kick stand down with your foot and pull up on the handle to raise the rear of the mower and install the transport wheels.
2. To release the kickstand, push the mower forward and then downward on handle.
3. Assure the traction and reel drive controls are in DISENGAGE and start the engine.
4. Set throttle control in SLOW, tip the front of the machine up and slowly increase engine speed while gradually engaging the traction drive so the mower moves forward slowly.
5. Adjust the throttle to operate the mower at the desired ground speed and transport the mower to desired destination.

## Preparing To Mow

1. Return the traction control lever to DISENGAGE, the throttle to SLOW and stop the engine.
2. Push the kickstand down with your foot and pull up on the handle to raise the wheels off the ground.
3. Push the locking clips on the wheels out of the grooves in the shafts and slide the wheels off the shafts.
4. Release the kick stand.

## Mowing Operation

Proper use of the Greensmaster 1000 provides the smoothest turf cutting available. The instructions will provide the utmost performance from your mower.

**Important:** Excessive operation of the cutting unit with the absence of grass clippings (lubricant) can damage the cutting unit.

## Before Mowing

Be sure the mower is carefully adjusted and is set evenly on both sides of the reel. Improper mower adjustment is magnified many times in the appearance of the clipped turf. Remove all foreign objects from the turf before mowing. Make sure everyone, especially children and pets, is clear of the work area.

## Method Of Mowing

The greens should be mowed in a straight back-and-forth direction across the green. Avoid circular mowing or turning the mower on greens areas since scuffing may occur. Turning the mower should be done off the green by raising the cutting reel (pushing the handle down) and turning on the traction drum. Mowing should be done at a normal walking pace. Fast speeds saves very little time and will result in an inferior mowing job.

## Control Operation

To operate the controls while mowing:

1. Start the engine, set the throttle at reduced speed, push down on the handle to raise the cutting unit, move the traction lever to ENGAGED and transport the mower onto the collar of green.
2. Move the traction lever to DISENGAGED and ENGAGE the reel drive lever.
3. Move the traction lever to the ENGAGED position, increase the throttle speed until the mower is traveling at the desired ground speed, drive the mower out onto the green area, lower the front of the mower and begin operation.

## After Mowing

1. Drive off the green, move the traction control lever to DISENGAGE, stop the engine and push the reel drive lever to DISENGAGED.
2. Empty the grass catcher of clippings, install grass catcher and commence transport operation.

# Maintenance

## Minimum Recommended Maintenance Intervals

| Maintenance Procedure                                                                                    | Maintenance Interval & Service |                                                                               |                            |                            |
|----------------------------------------------------------------------------------------------------------|--------------------------------|-------------------------------------------------------------------------------|----------------------------|----------------------------|
| Service air filter pre-cleaner.<br>Lubricate all grease fittings.<br>Check for loose fasteners.          | <b>Every<br/>25 hours</b>      | <b>Every<br/>50 hours</b>                                                     | <b>Every<br/>100 hours</b> | <b>Every<br/>200 hours</b> |
| Clean the fuel filter and sediment bowl.<br>Adjust the traction drive belts.<br>†Change the engine oil.  |                                |                                                                               |                            |                            |
| Check the cut-off bar adjustment.<br>Service the air cleaner filter.                                     |                                |                                                                               |                            |                            |
| Clean the combustion chamber.<br>Replace the spark plug.<br>Adjust the valves and torque the head bolts. |                                |                                                                               |                            |                            |
| †Initial break in at 20 hours                                                                            |                                |                                                                               |                            |                            |
| Replace all interlock switches                                                                           |                                | <b>Annual Recommendations:</b><br>Items listed are recommended every 2 years. |                            |                            |

## Daily Maintenance Checklist

Check the following daily:

- |                                                                                                                                                                                                                                   |                                                                                                                                                                                                                                                                                                                          |
|-----------------------------------------------------------------------------------------------------------------------------------------------------------------------------------------------------------------------------------|--------------------------------------------------------------------------------------------------------------------------------------------------------------------------------------------------------------------------------------------------------------------------------------------------------------------------|
| <ul style="list-style-type: none"> <li>✓ Safety interlock operation</li> <li>✓ Park brake operation</li> <li>✓ Fuel level</li> <li>✓ Engine oil level</li> <li>✓ Air filter</li> <li>✓ Clean the engine's cooling fins</li> </ul> | <ul style="list-style-type: none"> <li>✓ Unusual engine noises</li> <li>✓ Unusual operating noises</li> <li>✓ Reel-to-bedknife adjustment</li> <li>✓ Height-of-cut adjustment</li> </ul> <p>Lubricate all grease fittings immediately after every washing, regardless of the interval.</p> <p>Touch-up damaged paint</p> |
|-----------------------------------------------------------------------------------------------------------------------------------------------------------------------------------------------------------------------------------|--------------------------------------------------------------------------------------------------------------------------------------------------------------------------------------------------------------------------------------------------------------------------------------------------------------------------|

## Lubrication

The (13) grease fittings on the mower should be greased at least every 25 hours. Lubricate using No. 2 multi-purpose lithium base grease. A hand-operated grease gun is recommended for best results.

1. Wipe each grease fitting with a clean cloth.
2. The grease fitting locations are: (2) on the front roller (Fig. 17), (2) on the reel bearings (Fig. 17), (2) on the drum axles (Fig. 18), (3) on the differential (Fig. 18), (2) on the reel countershaft bearings (Fig. 19) and (2) on the belt idler pivots (Fig. 20).

**IMPORTANT: Do not apply too much pressure or the grease seals will become permanently damaged.**

3. Wipe off excess grease.

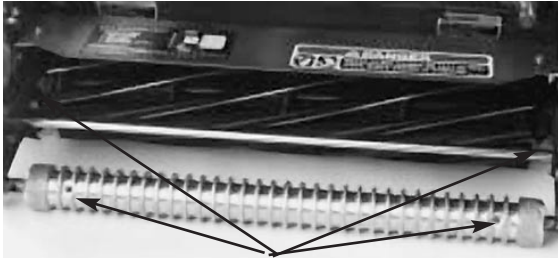

Figure 17

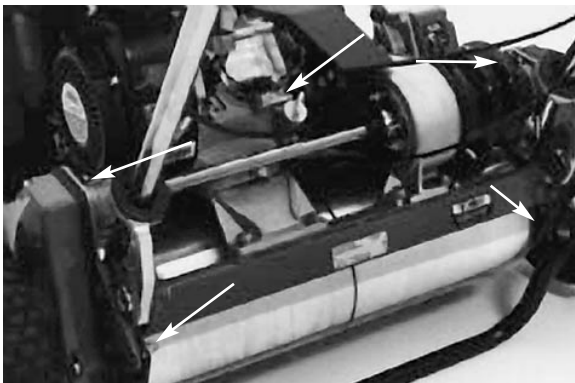

Figure 18

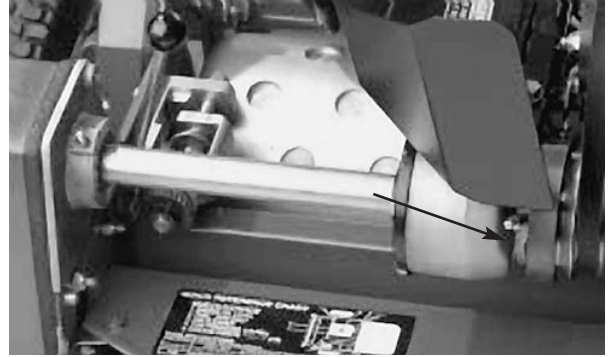

Figure 19



Figure 20

**CAUTION**

Shut the engine off, wait for all moving parts to stop and disconnect the spark plug wire (Fig. 21) before performing any maintenance procedures on the mower.

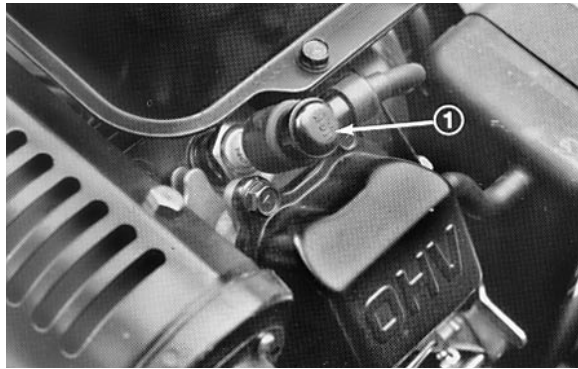
**Figure 21**

1. Spark plug

## Engine Oil

The TORO Company recommends that the oil level be checked each time mower is used or after every 5 operating hours. Initially, change oil after the first 20, every 50 hours of operation; thereafter, change oil after 50 hours of operation. More frequent oil changes are required in dusty or dirty conditions.

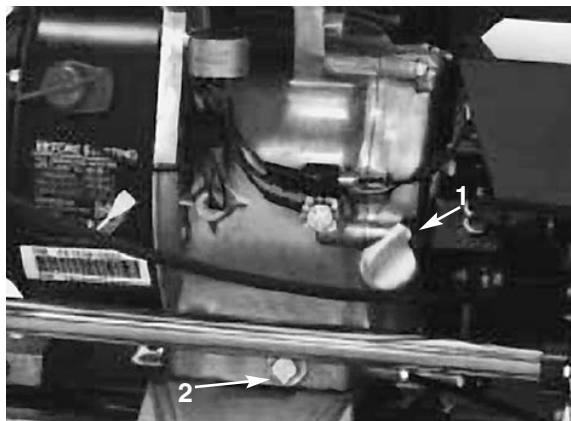
**Figure 22**

1. Oil level gauge  
2. Drain plug

### To check oil level:

1. Position mower so the engine is level and clean around oil level gauge (Fig. 22).

2. Remove oil level gauge by rotating it counterclockwise.
3. Wipe the oil level gauge clean and insert it into the filler port. Do not screw it into port. Then remove it and check the level of oil. If the level is low, add only enough oil (see chart below for proper viscosity) to raise the level to the filler opening.

Use any high-quality detergent oil having the American Petroleum Institute (API) “service classification”- SG, SH or SJ.

| Temperature   | Oil Viscosity   |
|---------------|-----------------|
| 10°C or below | SAE 10W30       |
| 10°C to 35°C  | SAE 10W30 or 30 |
| Above 35°C    | SAE 40          |

4. Reinstall oil level gauge and wipe up any spilled oil.

### To change oil:

1. Start and run the engine for a few minutes to warm the engine oil.
2. Place a drain pan at the rear of the machine under the drain plug (Fig. 22). Remove the drain plug.
3. Push down on the handle to tip the mower and engine backward, allowing more oil to run into a drain pan.
4. Reinstall the drain plug and refill the crankcase with proper oil: refer to *Check The Oil Level*.

## Servicing The Air Cleaner

Normally, clean the air cleaner after every 50 operating hours. More frequent cleaning is required when operating the mower in dusty or dirty conditions.

1. Make sure the spark plug wire is off the spark plug.
2. Remove the wing nuts securing the air cleaner cover to the air cleaner and remove the cover.

Clean the cover thoroughly (Fig. 23).

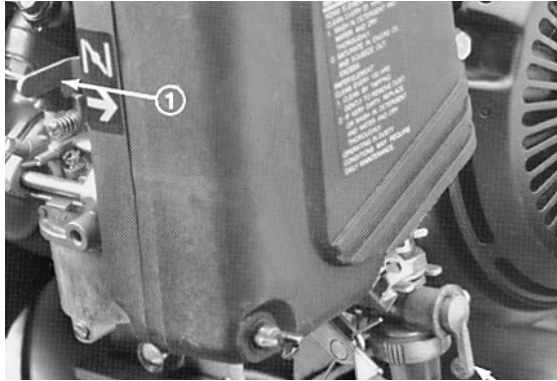

Figure 23

1. Air cleaner cover

3. If the foam element is dirty, remove it from the paper element (Fig. 24). Clean it thoroughly.

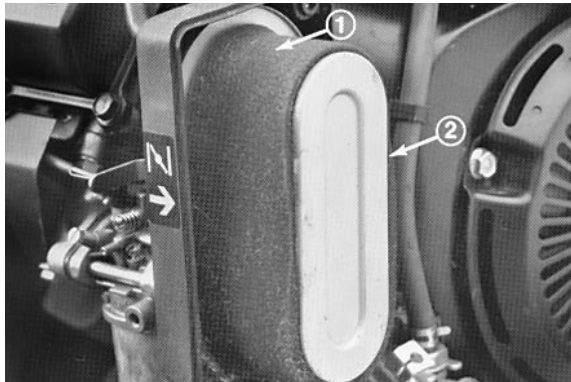

Figure 24

1. Foam element  
2. Paper element

- A. WASH the foam element in a solution of liquid soap and warm water. Squeeze it to remove dirt, but do not twist it because the foam may tear.
  - B. DRY by wrapping it in a clean cloth. Squeeze the cloth and foam element to dry.
  - C. SATURATE the element with clean engine oil. Squeeze the element to remove excess oil and to distribute oil thoroughly. An oil damp element is desirable.
4. When servicing the foam element, check the condition of the paper element. Clean or replace as required.
  5. Reinstall the foam element, paper element and air cleaner cover.

**IMPORTANT: Do not operate the engine without an air cleaner element because extreme engine wear and damage will likely result.**

## Replacing The Spark Plug

Use an NGK BPR 5ES spark plug or equivalent.

Correct air gap is 0.71–0.79mm (0.028”–0.031”). Remove the plug after every 100 operating hours and check its condition.

1. Pull the wire off the spark plug.
2. Clean around the spark plug and remove the plug from the cylinder head (Fig. 25)

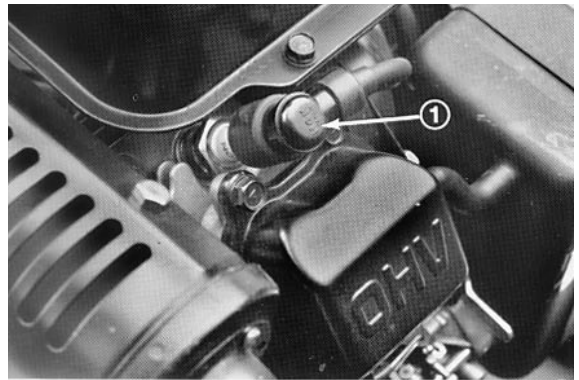

Figure 25

1. Spark plug

**IMPORTANT. Replace a cracked, fouled, or dirty spark plug. Do not sand blast, scrape, or clean electrodes because engine damage could result from grit entering cylinder.**

3. Set the air gap at 0.71–0.79mm (0.028”–0.031”) (Fig. 26). Install the correctly-gapped spark plug and tighten it firmly to 27 Nm (20 ft-lb.)

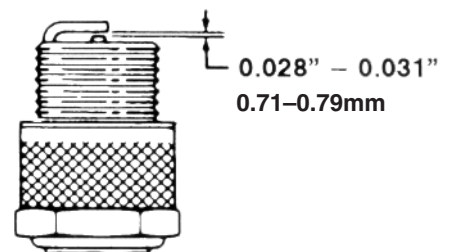

Figure 26

## Cleaning The Fuel Filter

Initially, clean the fuel filter after the first 20 hours of operation; thereafter clean it after every 50 hours operation.

1. Close the fuel shut-off valve and unscrew the bowl from the filter body (Fig. 27).



Figure 27

1. Shut-off valve
2. Bowl

2. Clean the bowl and filter in clean gasoline and reinstall.

## Adjusting Belts

Make sure belts are properly tensioned to assure proper operation of the machine and unnecessary wear. Check belts frequently.

### Reel Drive belt (Fig. 29)

1. Check tension by depressing the belt at mid span of pulleys with  $5 \pm 1$  Nm of force. The belt should deflect 6mm. If deflection is incorrect, go to next step. If correct, continue operation.
2. To adjust belt tension:
  - A. Remove the belt cover mounting screws and belt cover to expose the belt.



Figure 28

1. Reel drive belt cover

- B. Loosen the idler pulley mounting nut and pivot the idler pulley clockwise against the backside of the belt until the desired belt tension is attained. **DO NOT OVER TENSION THE BELT.**

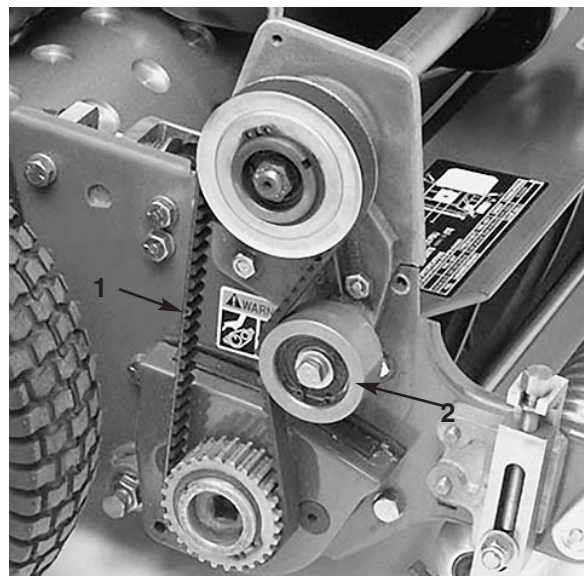

Figure 29

1. Reel drive belt
2. Idler pulley

- C. Tighten the nut to lock adjustment.

- D. Reinstall the belt cover by placing the cover in position. While maintaining a slight gap between the cover seal and the side plate, install each mounting bolt until the threads engage in the insert. The gap will allow visual alignment of the bolt to the threaded insert. After all bolts are installed, tighten until the stand offs inside the cover contact the side plate. Do not overtighten.

**Traction Drive belt (Fig. 30)**

1. Check tension by depressing belt at the mid span of pulleys with  $5 \pm 1$  Nm. of force. The belt should deflect 6mm. If deflection is incorrect, go to the next step. If correct, continue operation.
2. To adjust belt tension:
  - A. Remove the belt cover mounting screws and belt cover to expose the belt.

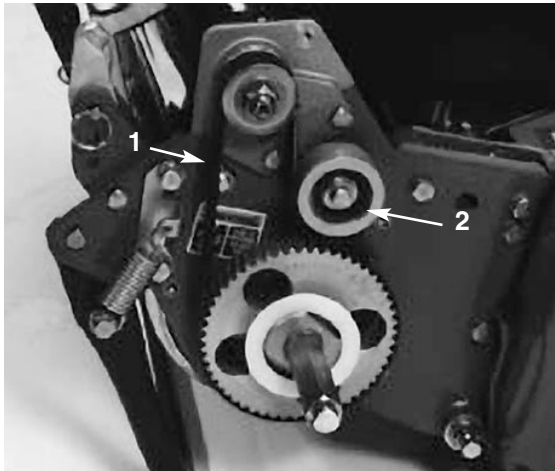

**Figure 30**

1. Traction drive belt
2. Idler pulley

- B. Loosen the idler pulley mounting nut and pivot the idler pulley clockwise against the backside of the belt until desired belt tension is attained. **DO NOT OVER TENSION THE BELT.**
- C. Tighten the nut to lock adjustment.

- D. Install the belt cover by placing the cover in position. While maintaining a slight gap between the cover seal and the side plate, install each mounting bolt until the threads engage in the insert. The gap will allow visual alignment of the bolt to the threaded insert. After all bolts are installed, tighten until the stand offs inside the cover contact the side plate. Do not overtighten.

**Differential belt (Fig. 31)**

1. Check tension by depressing belt at mid span of pulleys with  $7 \pm 1$  Nm of force. The belt should deflect 6mm. If deflection is incorrect, proceed to next step. If correct, continue operation.
2. To adjust belt tension:
  - A. Remove the capscrews securing the front and rear sections of the differential cover to the differential housing and slide the cover sections away to expose the belt.

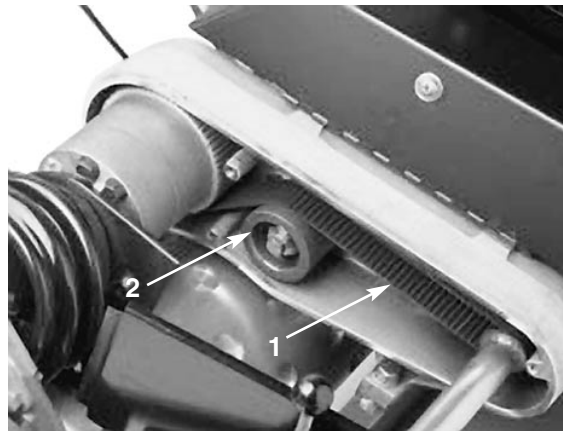

**Figure 31**

1. Differential belt
2. Idler pulley

- B. Loosen the idler pulley mounting nut and pivot the idler pulley clockwise against the backside of the belt until the desired belt tension is attained. **DO NOT OVER TENSION THE BELT.**
- C. Tighten the nut to lock adjustment.

- D. Reinstall the belt cover by placing the cover in position. While maintaining a slight gap between the cover seal and the side plate, install each mounting bolt until the threads engage in the insert. The gap will allow visual alignment of the bolt to the threaded insert. After all bolts are installed, tighten until the stand offs inside the cover contact the side plate. Do not overtighten.

### Primary v-belts (Fig. 32–33)

1. To adjust belt tension on primary V-belts, first check adjustment of the traction control. Refer to *Adjusting The Traction Control*. If unable to attain the 4–7 Nm force required in adjusting traction control, go to next step.
2. Loosen the retainer securing the V-belt cover and pivot the cover open.
3. To increase belt tension, loosen the engine mounting bolts and move the engine backwards in slots. **DO NOT OVER TENSION THE BELTS.** Tighten the mounting bolts.
4. After tensioning the primary V-belts, check the alignment of the engine output shaft pulley and countershaft pulley with a straight edge. If the pulleys are misaligned, loosen the screws securing engine mounting base to the mower frame and slide the engine from side to side until the pulleys are aligned within .0176mm.

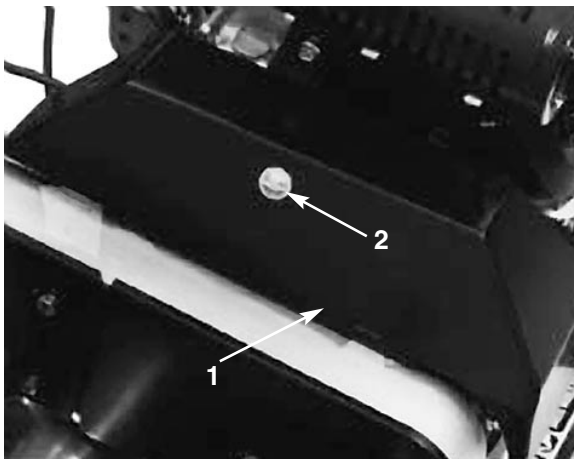

Figure 32

1. V- belt cover
2. Retainer

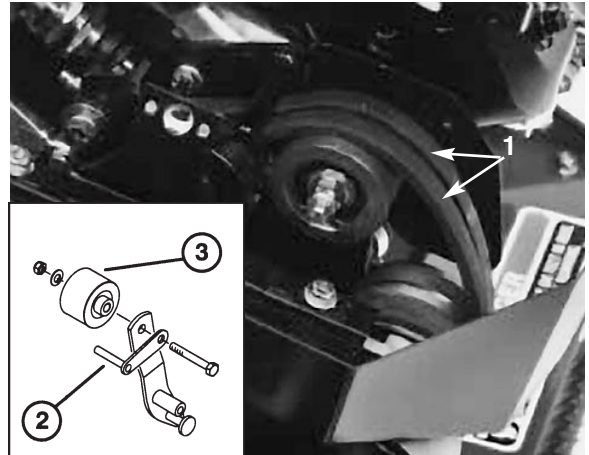

Figure 33

1. Primary V- belts
2. Belt guide
3. idler pulley

5. Tighten the mounting screws and recheck alignment.
6. Close cover and secure the retainer.
7. To push or pull the machine easier without starting the engine, adjust the belt guide (Fig. 33, inset) as follows:
  - A. Engage the clutch.
  - B. Loosen the capscrew securing the idler pulley and belt guide to the idler arm.
  - C. Rotate the belt guide clockwise until a gap of approximately 1.52mm is obtained between guide finger and backside of drive belts.
  - D. Tighten the capscrew and lock nut securing the idler pulley and belt guide to the idler arm. The 1.52mm dimension is a starting recommendation the actual gap may vary per machine.

### Differential Belt Replacement

1. Remove the capscrews securing the traction drive and reel drive belt covers to the right side plate and remove the belt covers.
2. Loosen the idler pulley mounting nut on each idler pulley and pivot each idler pulley counterclockwise away from the backside of each belt to release belt tension. Remove the belts.

3. Remove the capscrews; securing the front and rear sections of the differential cover to differential housing and slide the cover sections away to expose the belt (Fig. 34).
4. Loosen the idler pulley mounting nut on the differential idler pulley and pivot the idler pulley counterclockwise away from the backside of the belt to release belt tension.
5. Cut the old belt and remove it from the pulleys.
6. Remove the (2) capscrews and locknuts securing the front clutch housing to the side plate (Fig. 34). Rotate the housing 180°, so the bottom of housing points upward.
7. Remove (2) capscrews and locknuts securing the right rear bearing housing to the side plate (Fig. 34). Rotate the housing 180°, so the bottom of the housing points upward.

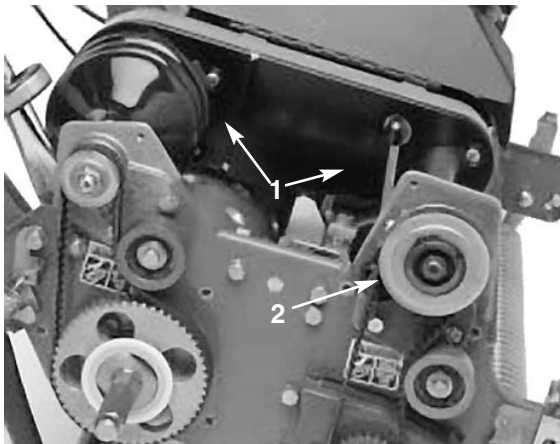

**Figure 34**

1. Differential cover sections
2. Front clutch housing
3. Right rear bearing housing

8. Slide the new belt over the rotated housing covers, differential cover sections and onto the differential pulleys. Make sure the idler pulley is positioned against the backside of the belt.
9. Rotate both housings back into the upright position and secure to side plate with capscrews and nuts previously removed.
10. Adjust differential belt tension, refer to *Adjusting The Differential Belt*.

11. Adjust belt tension on the traction drive and reel drive belts, refer to *Adjusting The Traction Drive and Reel Drive Belts*.
12. Reinstall the differential, traction drive and reel drive covers.

## Adjusting The Traction Control

If the traction control does not engage or it slips during operation, an adjustment is required.

1. Move the traction control to the DISENGAGED position.
2. Loosen the retainer securing V-belt cover and pivot the cover open (Fig. 32).
3. To increase cable tension, loosen the front cable jam nut and tighten back cable jam nut (Fig. 35) until a force of 4–7 Nm. is required to engage the traction control. Measure force at the control knob.
4. Tighten the front cable jam nut.
5. Close the cover and secure the retainer.
6. Check control operation.

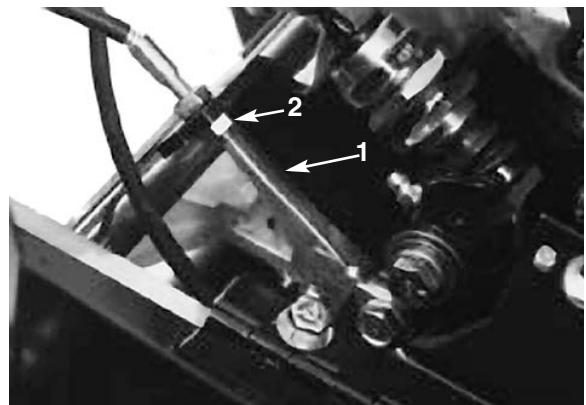

**Figure 35**

1. Traction cable
2. Front jam nut

## Adjusting The Service/Park Brake

If the service/park brake slips when operated, an adjustment is required.

1. Move the service/park brake lever to the OFF position.
2. Loosen the retainer securing the v-belt cover and pivot the cover open (Fig. 36).

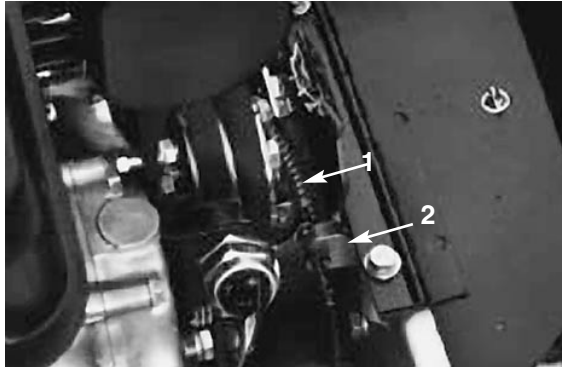

**Figure 36**

1. Service/park brake cable
2. Front jam nut

3. To increase cable tension, loosen the front cable jam nut and tighten back the cable jam nut (Fig. 35) until a force of 4–7 Nm. is required to engage the brake. Measure force at the lever knob. Do not *over* adjust, so brake band drags.
4. Close cover and secure the retainer.

## Adjusting The Throttle Control

If a new throttle cable must be installed or the cable becomes mis-adjusted, adjust as follows:

1. Move the throttle control to the SLOW position.
2. Loosen the screw securing the throttle cable to the carburetor arm (Fig 37).
3. The arm will move to idle position if improperly adjusted. Tighten the screw securing the cable to the arm. Make sure the throttle control is in the SLOW position.
4. Check setting with a tachometer.

Low idle speed is 800 rpm. High idle speed is 1800 rpm (See note below)

5. Adjust the idle speed screws in or out to attain correct speed setting.

**Note:** Speed is measured at the engine output shaft. Actual engine speed is twice the output shaft speed.

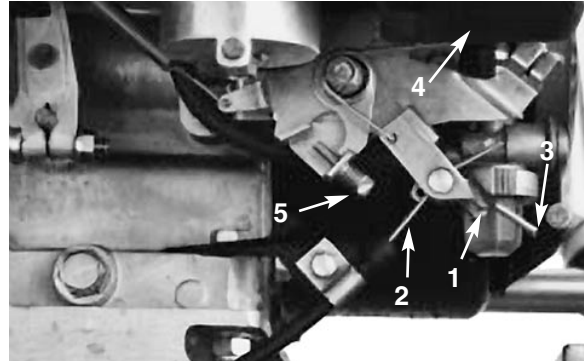

**Figure 37**

1. Throttle cable screw
2. Throttle cable
3. Carburetor arm
4. Low speed idle screw
5. High speed idle screw

## Adjusting The Interlock Switch

Use the following procedure if the switch needs adjustment or replacement.

1. Make sure the engine is OFF and the traction lever is DISENGAGED.
2. Loosen (2) switch mounting nuts (Fig. 38) and move the switch until the switch plunger is depressed  $.457 \pm .15\text{mm}$  (switch closed).
3. Tighten the switch mounting nuts.

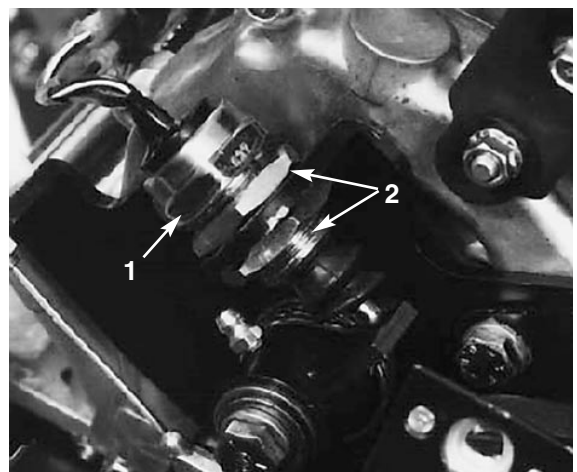

**Figure 38**

1. Interlock switch
2. Mounting nuts

- Engage the traction lever and verify that the switch plunger is depressed no more than 1.5mm (switch open). Readjust as required.

## Servicing The Bedbar

### Removal

- Turn the bedbar adjuster screw counter-clockwise, until the channel bottoms out in the adjuster frame (Fig. 39).

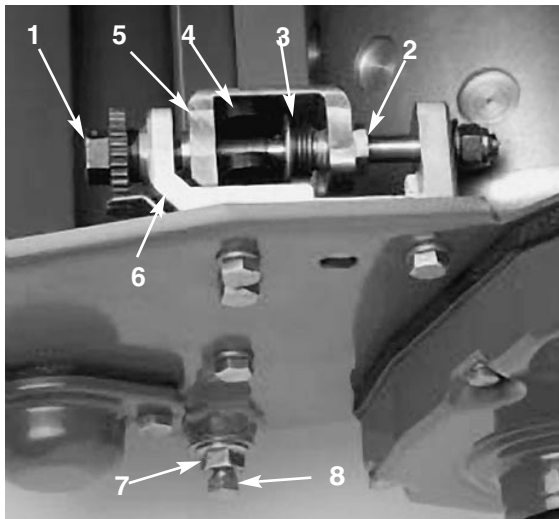

Figure 39

- Bedbar adjusting screw
- Spring tension screw
- Thrust washer
- Bedbar
- Channel
- Adjuster frame
- Jam nut
- Bedbar bolt

- Using a 7/8" standard wrench, back out the spring tension screw, until the trust washer is no longer tensioned against the bedbar (Fig. 38).
- On each side of the machine, loosen the jam nut securing the bedbar bolt (Fig. 39).
- Remove each bedbar bolt allowing bedbar to be pulled downward and removed from machine. Account for (2) nylon and (2) stamped steel washers on each end of bedbar (Fig. 39).

### Assembly

- Install the bedbar, positioning the mounting ears between the thrust washer and channel on

bedbar adjuster.

- Secure the bedbar to each side plate with bedbar bolts (flange nuts on bolts) and (8) washers. A nylon washer is to be positioned on each side of side plate boss. Place a steel washer outside each of the nylon washers. Torque bolts 27–36 Nm. Tighten the flange nuts until the thrust washers just rotate freely.
- Adjust the bedbar, refer to *Adjust The Bedknife To The Reel*.

## Reel Backlapping

- Remove plug in right reel drive cover (Fig, 40)

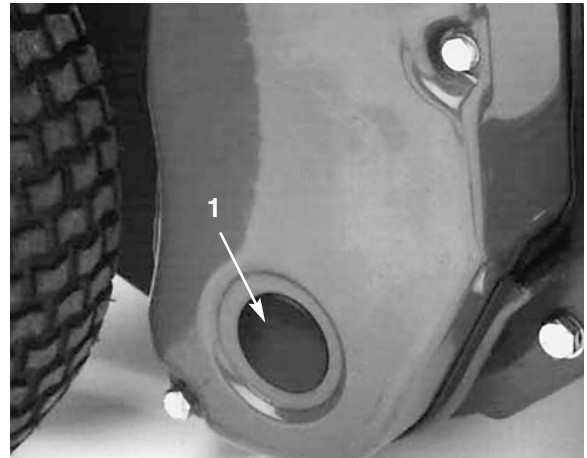

Figure 40

- Cover plug

- Insert a 1/2" socket extension, connected to back lapping machine, into the square hole in the center of reel pulley to backlap.
- Backlap according to procedure in TORO *Sharpening Reel and Rotary Mowers Manual*, Form No. 80-300 PT



### CAUTION



Be careful when lapping the reel because contact with reel or other moving parts can result in personal injury.

**Note:** For a better cutting edge, run a file across the front face of the bedknife when the lapping

operation is completed. This will remove any burrs or rough edges that may have built up on the cutting edge.

4. Reinstall plug in cover when backlap operation is completed.

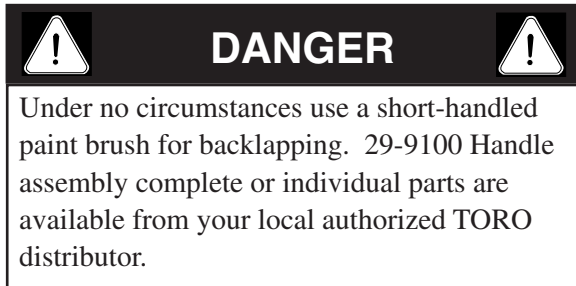

## Identification And Ordering

### Model And Serial Numbers

The Greensmaster® 1000 has two identification numbers: a model number and a serial number. These numbers are stamped into a plate located on rear of frame. In any correspondence concerning the unit, supply the model and serial numbers to ensure correct information and replacement parts are obtained.

**Note:** Do not order by reference number if a parts catalog is being used; use the part number.

To order replacement parts from an authorized TORO Distributor, supply the following information:

1. Model and serial numbers.
2. Part number, description, and quantity of parts desired.





