



MODEL NO. 03200 - 90001 & UP  
 MODEL NO. 03201 - 90151 & UP  
 MODEL NO. 03220  
 MODEL NO. 03221

OPERATOR'S  
 MANUAL

## REELMASTER® 3100-D

To understand this product, and for safety and optimum performance, read this manual before starting the engine. Pay special attention to SAFETY INSTRUCTIONS highlighted by this symbol.



It means CAUTION, WARNING or DANGER—personal safety instruction. Failure to comply with the instruction may result in personal injury.



This operator's manual has instructions on safety, operation, and maintenance.

This manual emphasizes safety, mechanical and general product information. DANGER, WARNING and CAUTION identify safety messages. Whenever the triangular safety alert symbol appears, understand the safety message that follows. "IMPORTANT" highlights special mechanical information and "NOTE" emphasizes general product information worthy of special attention.

## IDENTIFICATION AND ORDERING

### MODEL AND SERIAL NUMBER

The model and serial number for the traction unit is on a plate that is mounted on the left front frame member. The model and serial number for the cutting unit is on a plate that is mounted on the top front of the center cutting unit. Use model and serial number in all correspondence and when ordering parts.

To order replacement parts from an authorized TORO Distributor, supply the following information:

1. Model and serial numbers of the machine.
2. Part number, description and quantity of parts desired.

**NOTE:** Do not order by reference number if a parts catalog is being used; use the part number.

# Table of Contents

	Page
Safety	
Specifications	
Before Operating	
Controls	
Operating Instructions	
Maintenance	
Maintenance Schedule	
Aircleaner Maintenance	
Engine Maintenance	
Hydraulic Maintenance	
Brake Maintenance	
Electrical Maintenance	
Backlapping	
Preparation for Seasonal Storage	
Identification and Ordering	
The Toro Promise	

# Safety Instructions

To reduce the potential for any injury, comply with the following safety instructions.

## SUPERVISORS' RESPONSIBILITIES

1. Make sure operators are thoroughly trained and familiar with the operator's manual and all the labels on the machine.
2. Be sure to establish your own special procedures and work rules for unusual operating conditions (e.g., slopes too steep for machine operation). Survey the complete mowing site to determine which hills can be safely operated on. Always consider the turf condition and the rollover risk. To help determine which hills or slopes may be safely mowed, use the inclinometer provided with each machine. To perform a site survey, lay a 1.5-meter board on the slope surface and measure the angle of the slope. The board will average the slope but will not take into consideration dips or holes. **THE MAXIMUM SIDE HILL ANGLE SHOULD NOT BE GREATER THAN 25 DEGREES.**

## BEFORE OPERATING

3. Operate the machine only after reading and understanding the contents of this manual. A free replacement manual is available by sending complete model and serial number to your local Toro Distributor.
4. Only trained operators, skilled in slope operation and who have read this manual should operate the machine. Never allow children to operate the machine or adults to operate it without proper instructions.
5. Become familiar with the controls and know how to stop the machine and engine quickly.
6. Do not carry passengers on the machine. Keep everyone, especially children and pets, away from the areas of operation.
7. Keep all shields, safety devices and decals in place. If a shield, safety device or decal is damaged, malfunctioning or illegible, repair or replace it

before operating the machine.

8. Always wear substantial shoes. Do not operate the machine while wearing sandals, tennis shoes or sneakers. Do not wear loose fitting clothing because it could get caught in moving parts and possibly cause personal injury.
9. Wearing safety glasses, safety shoes, long pants and a helmet is advisable and required by some local authorities and insurance regulations.
10. Make sure the work area is clear of objects that might be picked up and thrown by the reels.
11. Fill the fuel tank with diesel fuel before starting the engine. Avoid spilling any fuel. Since fuel is highly flammable, handle it carefully.
  - A. Use an approved fuel container.
  - B. Do not remove the cap from the fuel tank when the engine is hot or running.
  - C. Do not smoke while handling diesel fuel.
  - D. Fill the fuel tank outdoors and not over 2.5 cm from the top of the tank, (bottom of the filler neck). Do not overfill.

## WHILE OPERATING

12. Do not run the engine in a confined area without adequate ventilation. Exhaust fumes are hazardous and could be deadly.
13. Sit on the seat when starting and operating the machine.
14. Check the interlock switches daily for proper operation (Refer To Checking The interlock Switches). Do not rely entirely on safety switches; shut off the engine before getting off the seat. If a switch fails, replace it before operating the machine. The interlock system is for your protection, so do not bypass it. Replace all interlock switches every two years.
15. The operator must be skilled and trained in how to

drive on hillsides. Failure to use caution on slopes or hills may cause vehicle to tip or roll, possibly resulting in personal injury or death. Always wear your seat belt.

16. This triplex mower has a unique drive system for superior traction on hills. The uphill wheel will not spin out and limit traction like conventional triplexes. If operated on a side hill that is too steep, rollover will occur before losing traction.
17. The slope angle at which the machine will tip depends on many factors, including mowing conditions such as wet or undulating turf, speed (especially in turns), position of the cutting units (with the sidewinder), tire pressure and operator experience. At hill slope angles of 20 degrees or less the risk of a rollover is low. As the slope angle increases to a maximum limit of 25 degrees, the risk of a rollover increases to a moderate level. **DO NOT EXCEED A 25 DEGREE SIDE HILL ANGLE BECAUSE THE RISK OF A ROLLOVER AND SERIOUS INJURY OR DEATH IS VERY HIGH.** Stay alert for holes in terrain and other hidden hazards. Use extreme caution when operating close to sand traps, ditches, creeks, steep hillsides or other hazards. Reduce speed when making sharp turns. Do not turn on hills. Avoid sudden stops and starts. Use the reverse pedal for braking. Cutting units must be lowered when going down slopes for steering control.
18. When starting the engine:
  - A. Engage the parking brake.
  - B. Be sure the traction pedal is in neutral and the reel drive is in the disengage position.
  - C. After the engine starts, release the parking brake and keep your foot off the traction pedal. The machine must not move. If there is movement, the neutral control linkage is incorrectly adjusted. In that case, shut the engine off and adjust the linkage until the machine does not move when the traction pedal is released. Refer to Adjusting The Transmission for Neutral.
19. Before backing up, look to the rear and assure no one is behind the machine. Watch out for traffic when near or crossing roads. Always yield the right of way.
20. Keep your hands, feet and clothing away from moving parts and the reel discharge area. Grass baskets, if so equipped, must be in place during reel operation for maximum safety.
21. This product may exceed noise levels of 85 dB(A) at the operator position. Ear protectors are recommended for prolonged exposure to reduce the potential of permanent hearing damage.
22. Raise the cutting units when driving from one work area to another.
23. Do not touch the engine, muffler, exhaust pipe or hydraulic tank while the engine is running or soon after it has stopped because these areas could be hot enough to cause burns.
24. If a cutting unit strikes a solid object or vibrates abnormally, stop immediately. Turn the engine off, wait for all motion to stop and inspect for damage. A damaged reel or bedknife must be repaired or replaced before operation is continued.
25. Before getting off the seat:
  - A. Move the traction pedal to neutral.
  - B. Set the parking brake.
  - C. Disengage the cutting units and wait for the reels to stop spinning.
  - D. Stop the engine and remove the key from the ignition switch.
26. Whenever the machine is left unattended, make sure the reels are not spinning, the key is removed from the ignition switch and the parking brake is set.

## MAINTENANCE

27. Before servicing or making adjustments to the machine, stop the engine and remove the key from the switch to prevent accidental starting of the engine.

28. Check performance of all interlock switches daily. Do not defeat the interlock system. It is for your protection.
29. To ensure the entire machine is in good operating condition, frequently check and keep all nuts, bolts, screws and hydraulic fittings tight.
30. Make sure all hydraulic line connectors are tight, and all hydraulic hoses and lines are in good condition before applying pressure to the system.
31. Keep your body and hands away from pin hole leaks or nozzles that eject hydraulic fluid under high pressure. Use paper or cardboard, not hands, to search for leaks. Hydraulic fluid escaping under pressure can have sufficient force to penetrate your skin and do serious damage. If fluid is injected into your skin it must be surgically removed within a few hours by a doctor familiar with this form of injury or gangrene may result.
32. Before disconnecting or performing any work on the hydraulic system, all pressure in the system must be relieved by stopping the engine and lowering the cutting units to the ground.
33. If major repairs are ever needed or if assistance is desired, contact an Authorized Toro Distributor.
34. To reduce potential fire hazard, keep the engine area free of excessive grease, grass, leaves and accumulation of dirt.
35. If the engine must be running to perform a maintenance adjustment, keep hands, feet, clothing, and any other parts of the body away from the cutting units and any moving parts. Keep everyone away.
36. Do not overspeed the engine by changing governor settings. To assure safety and accuracy, have an Authorized Toro Distributor check maximum engine speed with a tachometer.
37. The engine must be shut off before checking the oil or adding oil to the crankcase.

parts and accessories made by other manufacturers could be dangerous, and such use could void the product warranty of The Toro Company.

To insure optimum performance and safety, use genuine TORO replacement parts and accessories. Replacement

# Symbol Glossary

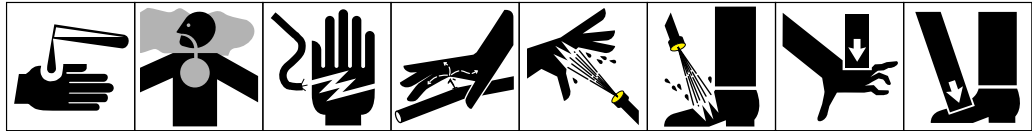

Caustic liquids, chemical burns to fingers or hand  
 Poisonous fumes or toxic gases, asphyxiation  
 Electrical shock, electrocution  
 High pressure fluid, injection into body  
 High pressure spray, erosion of flesh  
 High pressure spray, erosion of flesh  
 Crushing of fingers or hand, force applied from above  
 Crushing of toes or foot, force applied from above

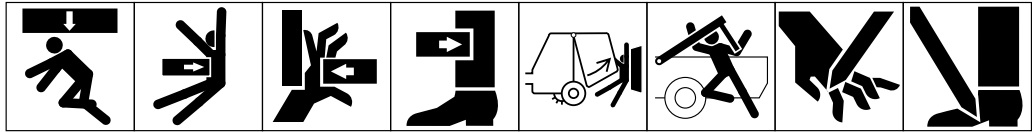

Crushing of whole body, applied from above  
 Crushing of torso, force applied from side  
 Crushing of fingers or hand, force applied from side  
 Crushing of leg, force applied from side  
 Crushing of whole body  
 Crushing of head, torso and arms  
 Cutting of fingers or hand  
 Cutting of foot

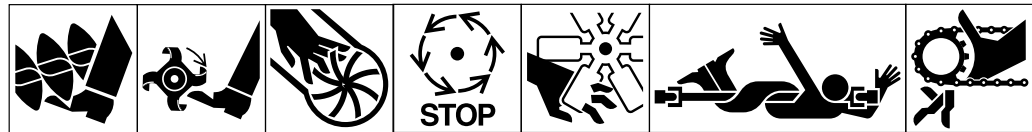

Cutting or entanglement of foot, rotating auger  
 Severing of foot, rotating knives  
 Severing of fingers or hand, impeller blade  
 Wait until all machine components have completely stopped before touching them  
 Severing of fingers or hand, engine fan  
 Whole body entanglement, implement input drive line  
 Fingers or hand entanglement, chain drive

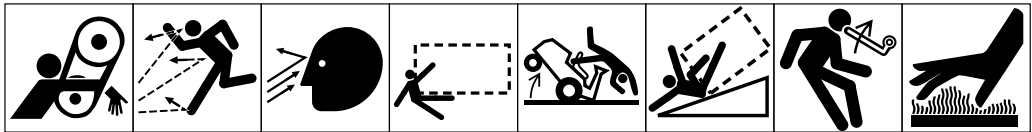

Hand & arm entanglement, belt drive  
 Thrown or flying objects, whole body exposure  
 Thrown or flying objects, face exposure  
 Runover/backover, (relevant machine to appear in dashed box)  
 Machine tipping, riding mower  
 Machine rollover, ROPS (relevant machine to appear in dashed box)  
 Stored energy hazard, kickback or upward motion  
 Hot surfaces, burns to fingers or hands

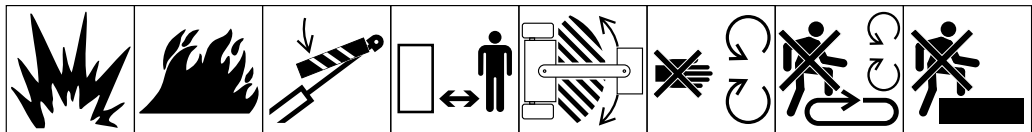

Explosion  
 Fire or open flame  
 Secure lifting cylinder with locking device before getting in hazardous area  
 Stay a safe distance from the machine  
 Stay clear of articulation area while engine is running  
 Do not open or remove safety shields while engine is running  
 Do not step on loading platform if PTO is connected to tractor & engine is running  
 Do not step

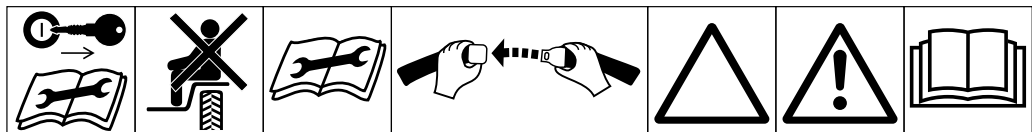

Shut off engine & remove key before performing maintenance or repair work  
 Riding on this machine is allowed only on a passenger seat & only if the driver's view is not hindered  
 Consult technical manual for proper service procedures  
 Fasten seat belts  
 Safety alert triangle  
 Outline safety alert symbol  
 Read operator's manual

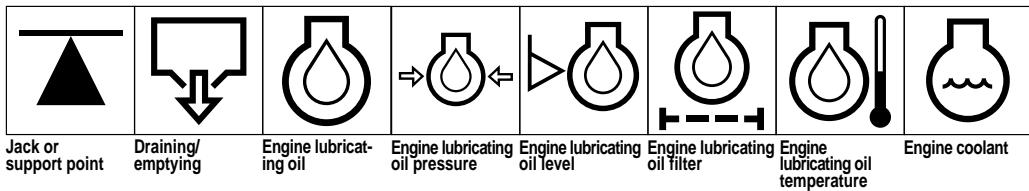
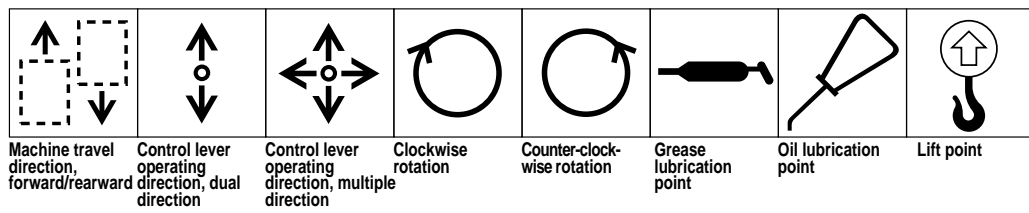
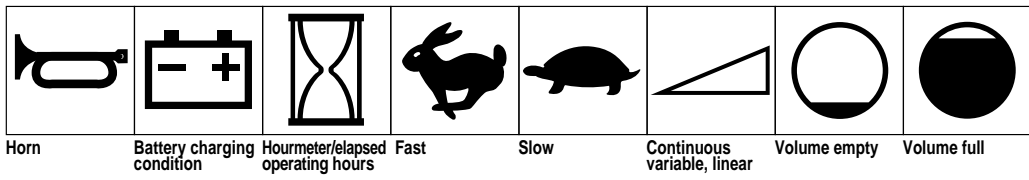
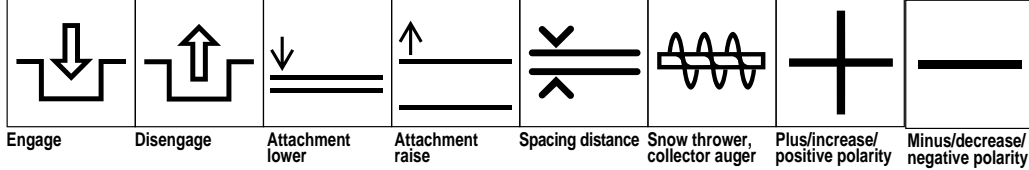
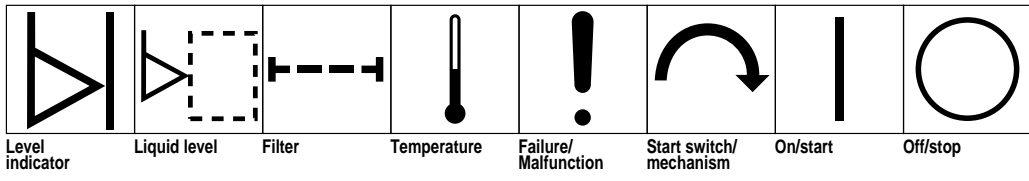
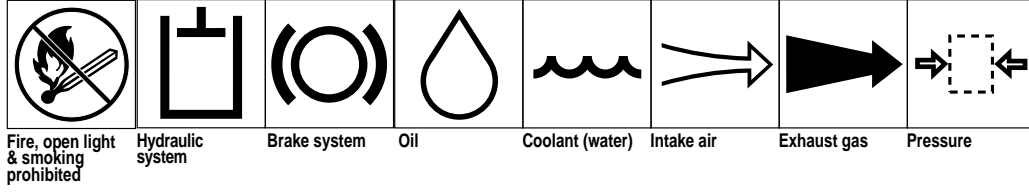
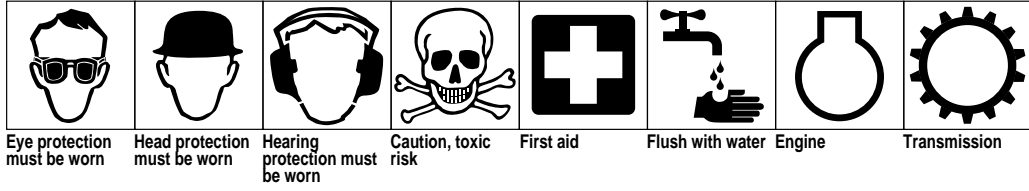

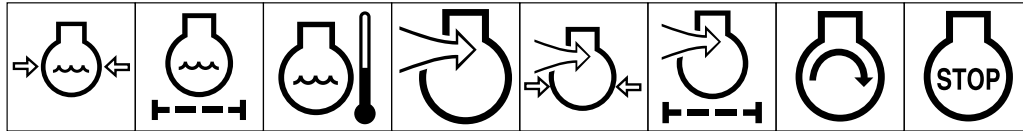

Engine coolant pressure   Engine coolant filter   Engine lubricating oil pressure   Engine intake/combustion air   Engine intake/combustion air pressure   Engine intake/air filter   Engine start   Engine stop

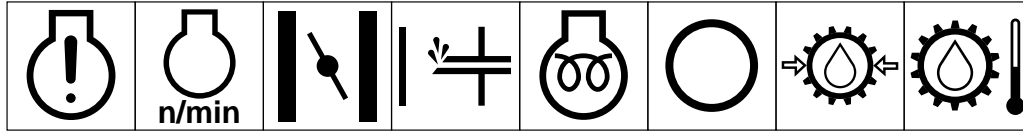

Engine failure/malfunction   Engine rotational speed/frequency   Choke   Primer (start aid)   Electrical preheat (low temperature start aid)   Transmission oil   Transmission oil pressure   Transmission oil temperature

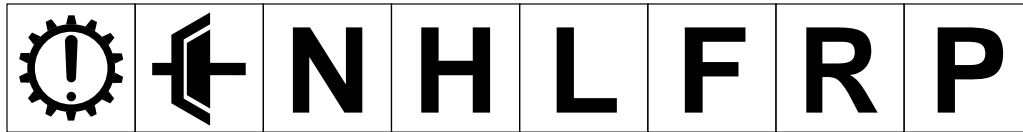

Transmission failure/malfunction   Clutch   Neutral   High   Low   Forward   Reverse   Park

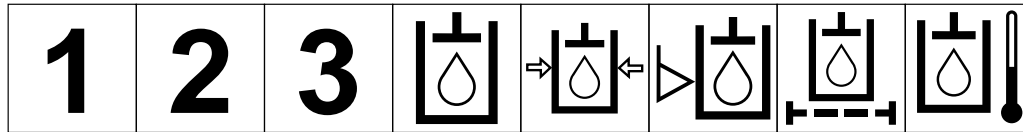

First gear   Second gear   Third gear (other #'s may be used until the maximum # of forward gears is reached.)   Hydraulic oil   Hydraulic oil pressure   Hydraulic oil level   Hydraulic oil filter   Hydraulic oil temperature

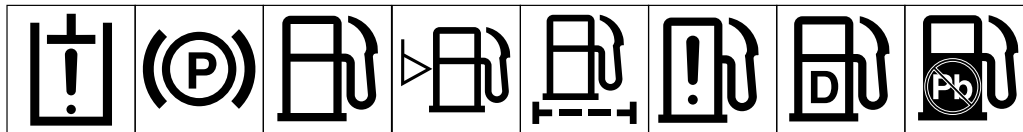

Hydraulic oil failure/malfunction   Parking brake   Fuel   Fuel level   Fuel filter   Fuel system failure/malfunction   Diesel fuel   Unleaded fuel

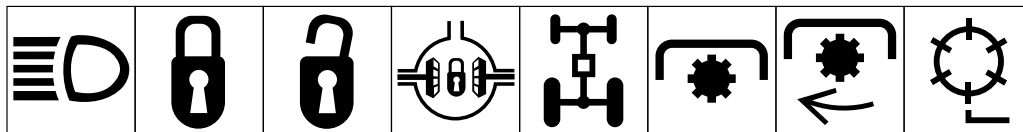

Headlights   Lock   Unlock   Differential lock   4-Wheel drive   Power Take-Off   Power Take-Off rotational speed   Reel cutting element

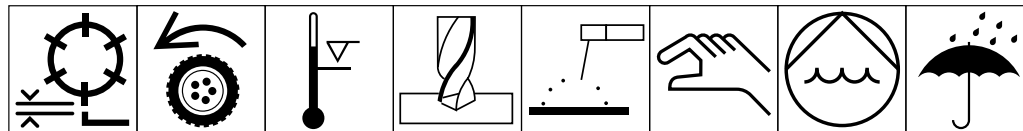

Reel cutting element height adjustment   Traction   Above working temperature range   Drilling   Manual metal arc welding   Manual   0356 Water pump   0626 Keep dry

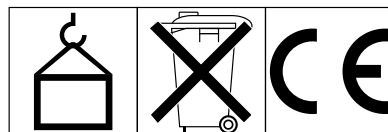

0430 weight   Do not dispose in the garbage   CE logo



# Specifications

**Engine:** Kubota three-cylinder, 4-cycle, liquid-cooled diesel engine. 16kW 2500 rpm. Governed to 2650 rpm. 1124 cc displacement. Heavy-duty, 2-stage, remote mounted air cleaner. High water temperature shutdown switch.

**Cooling System:** Radiator capacity is approximately 5.7 L of 50/50 mixture of ethylene glycol anti-freeze. Remote mounted 1 L expansion tank.

**Electrical:** 12-volt Group 55, 450-cold cranking amps at -18°C, 75-minute reserve capacity at 27°C. 40-amp alternator with regulator/rectifier. Seat switch, PTO, parking brake and traction interlock switches.

**Fuel Capacity:** 28.4 L.

**Traction Drive:** High-torque hydraulic wheel motors. 3-wheel drive. Oil cooler and shuttle valve provide positive closed-loop cooling.

**Hydraulic Oil Capacity/Filter:** Remote-mounted, 13.2 L oil reservoir. 10-micron remote-mounted spin-on filter.

**Ground Speed:** Infinitely variable speed selection in forward and reverse.

**Mowing speed:** 0–9.7 kmh (adjustable) Transport speed: 0–14.5kmh. Reverse speed: 0–5.6 kmh.

**Tires/Wheels:** All tires are 20 x 10-10 tubeless, 4-ply rating with demountable rims. Recommended tire pressure: 97–124 kPa front and rear tires.

**Frame:** Tricycle vehicle with 3-wheel traction drive and rear wheel steering. Frame consists of formed steel, welded steel and steel tubing components.

**Steering:** Power steering.

**Brakes:** Service braking accomplished through dynamic characteristics of Hydrostat. The parking or emergency brake is actuated by ratchet hand lever on the operator's RIGHT hand side.

**Controls:** Foot-operated forward and reverse traction pedals and Mow/Transport slide. Hand-operated throttle, ignition switch, reel engagement switch, reel unit lift and

shift lever, parking brake and seat adjustment.

**Note:** Shift lever only on Model 03201.

**Gauges and Protective Systems:** Hour meter. 4-light warning cluster gauge: oil pressure, water temperature, amps and glow plug.

**Seat:** Optional standard or deluxe seats.

**Cutting Unit Lift:** Hydraulic lift with automatic reel shut off.

**Optional Equipment:**

Standard Seat	Model 03224
Deluxe Suspension Seat	Model 03225

# Before Operating



## CAUTION

Before servicing or making adjustments to the machine, stop the engine and remove the key from the switch.

## CHECK CRANKCASE OIL (Fig. 1–2)

The engine is shipped with oil in the crankcase; however, the oil level must be checked before and after the engine is first started.

Crankcase capacity is 2.8 l with the filter.

1. Position the machine on a level surface.
2. Remove the dipstick and wipe it with a clean cloth. Push the dipstick down into the dipstick tube and make sure it seats fully. Pull the dipstick out and check the oil level. If it is low, add enough oil to raise the level to the FULL mark on the dipstick.



Figure 1

1. Dipstick

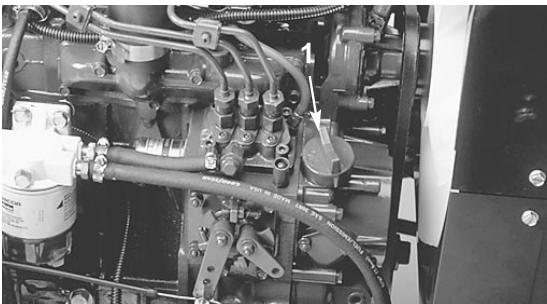

Figure 2

1. Oil fill cap

3. If the oil level is low, remove the oil fill cap and gradually add small quantities of oil, checking the level frequently, until the level reaches the FULL mark on the dipstick.
4. The engine uses any high-quality 10W30 detergent oil having the American Petroleum Institute—API—“service classification” CD, CE, CF CF-4 or CG-4.
5. Install the oil fill cap and close the hood.

**IMPORTANT: Check the level of oil every 5 operating hours or daily. Change the oil after every 50 hours of operation.**

## FILL THE FUEL TANK (Fig. 3)

The engine runs on No. 2 diesel fuel. Fuel tank capacity is approximately 28.4 L.

1. Clean the area around the fuel tank cap.

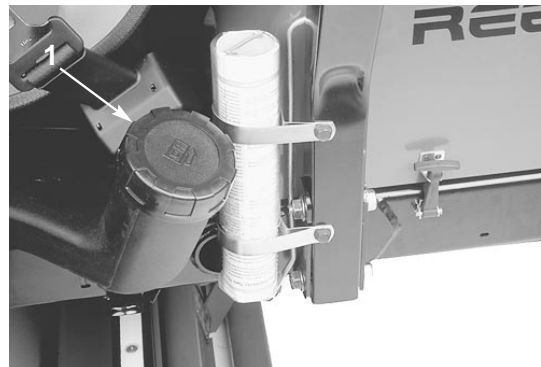

Figure 3

1. Fuel tank cap

2. Remove the fuel tank cap.
3. Fill the tank to bottom of the filler neck. **DO NOT OVERFILL.** Then install the cap.
4. Wipe up any fuel that may have spilled to prevent a fire hazard.

**DANGER**

Because diesel fuel is flammable, use caution when storing or handling it. Do not smoke while filling the fuel tank. Do not fill the fuel tank while the engine is running, hot, or when the machine is in an enclosed area. Always fill the fuel tank outside and wipe up any spilled diesel fuel before starting the engine. Store the fuel in a clean, safety-approved container and keep the cap in place. Use Diesel fuel for the engine only; not for any other purpose.

## CHECK THE COOLING SYSTEM (Fig. 4 & 5)

Clean debris from the radiator and oil cooler daily; hourly if conditions are extremely dusty and dirty; refer to *Cleaning The Radiator*.

1. The cooling system is filled with a 50/50 solution of water and permanent ethylene glycol anti-freeze. Check the level of coolant at the beginning of each day before starting the engine. Cooling system capacity is 5.7 L.

**CAUTION**

If the engine has been running, pressurized hot coolant can escape when the radiator cap is removed and cause burns. Only open the radiator cap when the engine is cold.

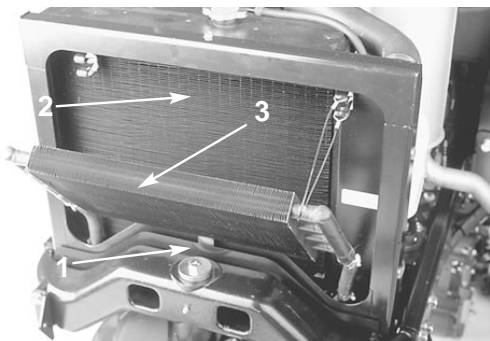
**Figure 4**

1. Access panel
2. Radiator
3. Oil cooler

2. Check the level of coolant in the expansion tank. With a cold engine, coolant level should be midway between the marks on side of the tank.

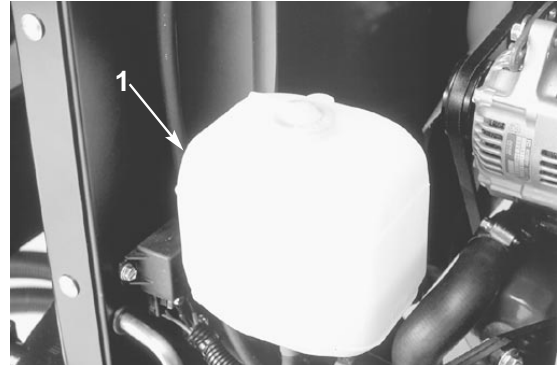
**Figure 5**

1. Expansion tank

3. If coolant level is low, remove the expansion tank cap and replenish the system. **DO NOT OVERFILL.**
4. Install the expansion tank cap.

## CHECK THE HYDRAULIC SYSTEM FLUID (Fig. 6)

The hydraulic system driving the reels is designed to operate on anti-wear hydraulic fluid. The machine's reservoir is filled at the factory with 13.2 L of DTE 15M hydraulic fluid. Check the level of hydraulic fluid before the engine is first started and daily thereafter.

**IMPORTANT: Use only the types of hydraulic fluids specified. Other fluids could cause system damage.**

**Note:** A red dye additive for the hydraulic system fluid is available in 2/3 oz. bottles. One bottle is sufficient for 15-19 L. of hydraulic fluid. Order Part No. 44-2500 from your Authorized Toro Distributor.

1. Position the machine on a level surface, lower the cutting units and stop the engine.
2. Clean the area around the filler neck and cap of hydraulic tank. Remove the cap from the filler neck.

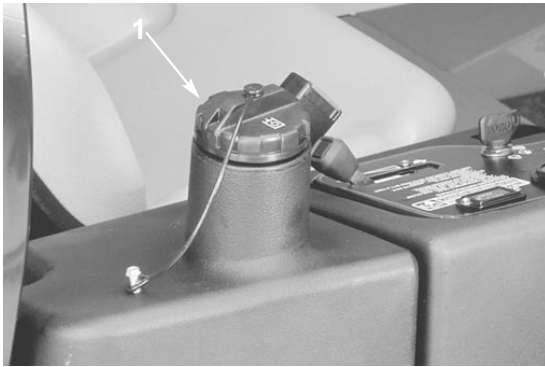

**Figure 6**

1. Hydraulic Tank Cap

3. Remove the dipstick from the filler neck and wipe it with a clean cloth. Insert the dipstick into the filler neck; then remove it and check the level of fluid. Fluid level should be within 6 mm of the mark on the dipstick.
4. If the level is low, add appropriate fluid to raise the level to the full mark.
5. Install the dipstick and cap onto the filler neck.

## CHECK TIRE PRESSURE

The tires are overinflated for shipping. Release some of the air to reduce the pressure. Correct air pressure in tires is 97–124 kPa.

**IMPORTANT: Maintain recommended pressure in all tires to assure a good quality of cut and proper machine performance. DO NOT UNDER INFLATE.**

## CHECK THE REEL-TO-BEDKNIFE CONTACT

Each day before operating, check the reel-to-bedknife contact, regardless of whether the quality of cut was previously acceptable. There must be light contact across the full length of the reel and bedknife (refer to *Adjusting The Reel-to-Bedknife Contact* in the cutting unit operator's manual).

## CHECK WHEEL NUT TORQUE

Torque wheel nuts to 61–88 Nm after 1–4 hours of operation and again after 10 hours of operation and every 200 hours thereafter. Failure to maintain proper torque could result in failure or loss of a wheel and may result in personal injury.



### WARNING

Torque wheel nuts to 61–88 Nm after 1–4 hours of operation and again after 10 hours of operation and every 200 hours thereafter. Failure to maintain proper torque could result in failure or loss of a wheel and may result in personal injury.

# Controls

**Traction Pedals** (Fig. 7)—Depress the traction-forward pedal to move forward. Depress the traction-reverse pedal to move backward or to help stop the machine when moving forward. Also, allow the pedal to move to the neutral position to stop the machine.

**Mow/Transport Slide** (Fig. 7)—Using your heel, move the slide to the left to transport the machine and to the right to mow. The cutting units will only operate in the mow position.

**Note:** Mow speed is set at the factory to 6 mph. It can be increased or decreased by adjusting the speed stop screw (Fig. 8)

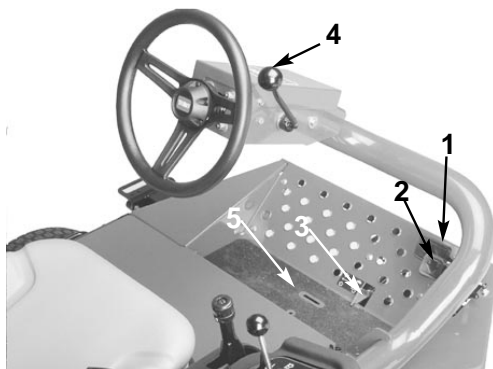

Figure 7

1. Forward traction pedal
2. Reverse traction pedal
3. Mow/Transport slide
4. Tilt steering lever
5. Indicator slot

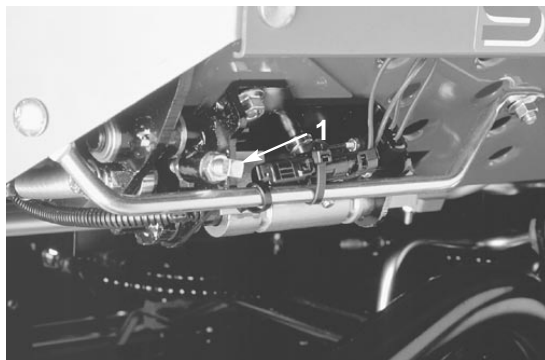

Figure 8

1. Speed Stop Screw

**Tilt Steering Lever** (Fig. 7)—Pull the lever back to tilt the steering wheel to the desired position. Then push the

lever forward to tighten the steering wheel position.

**Starter Switch** (Fig. 9)—The starter switch has three positions: OFF, ON/PREHEAT and START. Turn the key to the ON/PREHEAT position until the glow plug indicator light goes out (approximately 7 seconds), then turn the key to the START position to engage the starter. Release the key when the engine starts. The key will move automatically to the ON/RUN position. To shut the engine off, turn the key to the OFF position. Remove the key from the switch to prevent accidental starting.

**Throttle** (Fig. 9)—Moving the throttle forward increases engine speed; moving it rearward decreases engine speed.

**Cutting Unit Shift Lever** (Fig. 9)—To lower the cutting units to the ground, move the lift lever forward. The cutting units will not drop unless the engine is running and will not operate in the raised position. To raise the cutting units, pull the lift lever rearward to the RAISE position.

**Model 03201 only:** Move the lever to the right or left to move the cutting units in the same direction. This should only be done when the cutting units are raised or if they're on the ground and the machine is moving.

**Note:** The lever does not have to be held in the forward position while the cutting units are lowered.

**Indicator Slot** (Fig. 9)—The slot in the operator's platform indicates when the cutting units are in the center position.

**Cutting Unit Drive Switch** (Fig. 9): The switch has two positions: ENGAGE and DISENGAGE. A rocker switch operates a solenoid valve to drive the cutting units.



**Figure 9**

1. Throttle
2. Hour meter
3. Temperature light
4. Oil pressure light
5. Glow plug indicator light
6. Alternator light
7. Cutting unit drive switch
8. Cutting unit shift lever
9. Ignition switch
10. Parking brake
11. Lift lever lock

**Hour Meter** (Fig. 9)—Indicates the total hours of machine operation. The hour meter functions whenever the key switch is ON.

**Engine Coolant Temperature Warning Light** (Fig. 9)—This light glows if the engine coolant temperature is high. If the traction unit is not stopped and coolant temperature rises, the engine will stop.

**Oil Pressure Warning Light** (Fig. 9)—This light glows if the engine oil pressure drops below a safe level.

**Alternator Light** (Fig. 9)—The light should be off when the engine is running. If it is on, the charging system should be checked and repaired as necessary.

**Glow Plug Indicator** (Fig. 9)—The light will glow when the glow plugs are operating.

**Parking Brake** (Fig. 9)—Whenever the engine is shut off, the parking brake must be engaged to prevent accidental movement of the machine. To engage the parking brake, pull up on the lever. The engine will stop if the traction pedal is depressed with the parking brake engaged.

**Lift Lever Lock** (Fig. 9)—Move the lever rearward to prevent the cutting units from dropping.

**Reel Speed Control** (Fig. 10)—(Located under console

cover)—To obtain the desired clip rate (reel speed), turn the reel speed control knob to the appropriate setting for height of cut and mower speed. Refer to the *Selecting Clip Rate* section of the manual.

**Backlap Control** (Fig. 10)—(Located under console cover) Turn the knob clockwise for backlapping and counterclockwise for mowing. Do not change the knob position when the reels are turning.

**Fuel Gauge** (Fig. 11)—Shows the amount of fuel in the tank.

**Seat Adjustments** (Fig. 11) Fore and Aft Adjustment—Move the lever on the side of the seat outward, slide the seat to the desired position and release the lever to lock the seat into position.

**Deluxe Seat Adjustments Weight Adjustment**—Push the lever up or down to adjust to the operator's weight. Lever up—light operator, lever in middle position—medium-weight operator or lever down for a heavy operator. Inclining Backrest—Turn the handle to adjust the angle of the backrest.

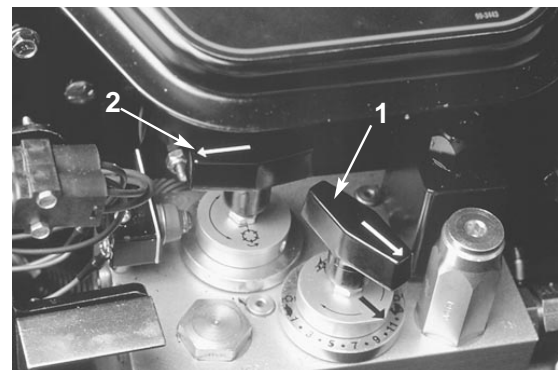

**Figure 10**

1. Reel speed control
2. Backlap control



**Figure 11**

1. Fore and aft lever
  2. Fuel gauge
-

# Operating Instructions

## STARTING/STOPPING THE ENGINE

**IMPORTANT:** The fuel system may have to be bled if any of the following situations have occurred:

- A. Initial start up of a new engine.
- B. The engine has run out of fuel.
- C. Maintenance has been performed on fuel system components; i.e., filter replaced, etc.

Refer to Bleeding The Fuel System

1. Be sure the parking brake is set and the reel drive switch is in the DISENGAGE position.
2. Remove your foot from the traction pedal and make sure the pedal is in the neutral position.
3. Move the throttle lever to half-throttle position.
4. Insert the key into the switch and turn it to ON/PREHEAT until the glow plug indicator light goes out (approximately 7 seconds). Then turn the key to START. Release the key when the engine starts. The key will move automatically to the ON/RUN position.

**IMPORTANT:** To prevent overheating of the starter motor, do not engage the starter longer than 15 seconds. After 10 seconds of continuous cranking, wait 60 seconds before engaging the starter motor again.

5. When the engine is started for the first time, or after overhaul of the engine, operate the machine in forward and reverse for one to two minutes. Also operate the lift lever and the reel drive switch to be sure of proper operation of all parts.

Turn steering wheel to the left and right to check steering response. Then shut the engine off and check for oil leaks, loose parts and any other noticeable malfunctions.



### CAUTION

Shut the engine off and wait for all moving parts to stop before checking for oil leaks, loose parts and other malfunctions.

6. To stop the engine, move the throttle control to IDLE position, move the reel drive switch to DISENGAGE and turn starter key to OFF. Remove the key from the switch to prevent accidental starting.

## BLEEDING THE FUEL SYSTEM (Fig. 12)

1. Park the machine on a level surface. Make sure the fuel tank is at least half full.
2. Unlatch and raise the hood.



### DANGER

Because diesel fuel is flammable, use caution when storing or handling it. Do not smoke while filling the fuel tank. Do not fill the fuel tank while the engine is running, hot, or when the machine is in an enclosed area. Always fill the fuel tank outside and wipe up any spilled diesel fuel before starting the engine. Store fuel in a clean, safety-approved container and keep the cap in place. Use diesel fuel for the engine only; not for any other purpose.

3. Open the air bleed screw on the fuel injection pump (Fig. 16).
4. Turn the key in the ignition switch to the ON position. The electric fuel pump will begin operation, forcing air out around the air bleed screw. Leave the key in the ON position until a solid stream of fuel flows out around the screw. Tighten the screw and turn the key to OFF.





**Figure 12**

1. Fuel injection pump bleed screw

**Note:** Normally, the engine should start after the above bleeding procedures. However, if the engine does not start, air may be trapped between the injection pump and the injectors; refer to *Bleeding Air From The Injectors*.

## CHECK OPERATION OF THE INTERLOCK SWITCHES



### CAUTION

Do not disconnect the safety switches because they are for the operator's protection. Check switch operation daily to be sure the interlock system is operating correctly. If a switch is not operating correctly, replace it before operating the machine. Replace the switches every two years to be sure of maximum safety.

1. Make sure all bystanders are away from the area of operation. Keep your hands and feet away from the cutting units.
2. With the operator on the seat, the engine must not start with either the reel switch engaged or the traction pedal engaged. Correct problem if not operating properly.
3. With the operator on the seat, the traction pedal in neutral, the parking brake off and the reel switch in the OFF position, the engine should start. Rise from the seat and slowly depress the traction pedal; the engine should stop in one to three seconds. Correct the problem if this does not happen.

4. With the operator on the seat, the engine running, the reel transport slide in mow and the reel switch in the ON position, lower the cutting units. The reels should come on. Pull back on the lift lever, the reels should stop when fully raised. Correct the problem if this does not happen.

**Note:** The machine is equipped with an interlock switch on the parking brake. The engine will stop if the traction pedal is depressed with the parking brake engaged.

## TOWING THE TRACTION UNIT (Fig. 13)

In case of emergency, the Reelmaster can be towed for a short distance. However, Toro does not recommend this as a standard procedure.

**IMPORTANT:** Do not tow the machine faster than 2–3 mph because drive system may be damaged. If the machine must be moved a considerable distance, transport it on a truck or trailer.

1. Locate the by-pass valve on the pump and turn it 90°

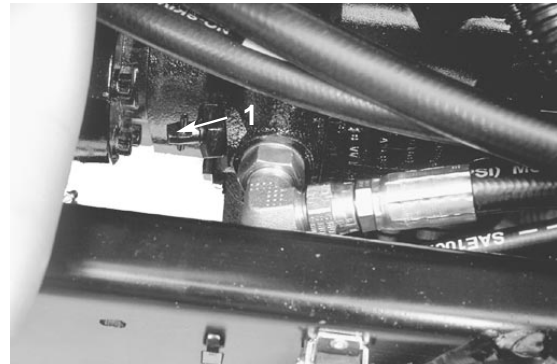

**Figure 13**

1. By-pass valve

2. Before starting the engine, close the by-pass valve by rotating it 90°. Do not start the engine when the valve is open.

## OPERATING CHARACTERISTICS



### DANGER

The mower has a unique traction system that will allow the machine to move forward on side hills, even if the uphill wheel should rise off the ground. If this should happen, the operator or any bystanders can be seriously injured or killed in a rollover.

The slope angle at which the machine will tip depends on many factors including mowing conditions such as wet or undulating turf, speed (especially in turns), position of the cutting units (with Sidewinder), tire pressure and operator experience.

At side hill angles of 20 degrees or less, the risk of a rollover is low. As the slope angle increases to a Toro-recommended maximum limit of 25 degrees the risk of a rollover increases to a moderate level. **DO NOT EXCEED A 25-DEGREE SIDE HILL SLOPE ANGLE BECAUSE THE RISK OF A ROLLOVER AND SERIOUS INJURY OR DEATH IS VERY HIGH.**

To determine on which hills or slopes you may safely operate, a site survey of the mowing area must be done. When performing this site survey always take into consideration the turf condition and the rollover risk. Use the inclinometer provided with each machine. To perform a site survey, lay a 1.5-meter board on the slope surface and measure the angle of the slope. The board will average the slope but will not take into consideration dips or holes. **THE MAXIMUM SIDE HILL ANGLE SHOULD NOT BE GREATER THAN 25 DEGREES.**

Practice operating the Reelmaster and become thoroughly familiar with it.

Start the engine and run it at half idle until it warms up. Push the throttle lever all the way forward, lift the cutting units, disengage the parking brake, press the forward-traction pedal and carefully drive to an open area.

Practice going both forward and in reverse, starting and stopping the machine. To stop, take your foot off the

traction pedal and let it return to neutral or press down on the reverse pedal to stop. Going down a hill, you may need to use the reverse pedal to stop.

When driving on slopes, drive slowly to maintain steering control and avoid turns to prevent rollovers. In side hill situations, shift the sidewinder cutting units to the up-hill side for more stability. Always do this before going on a side hill. Conversely, shifting the cutting units to the down-hill side results in less stability. .

When possible, mow up and down hills rather than across them. Have the cutting units lowered when going down a hill to maintain steering control. Do not attempt to turn on a hill.

Practice driving around obstacles with the reels up and down. Be careful when driving between narrow objects so that you don't damage the machine or cutting units.

On the Sidewinder unit, develop an understanding for the reach of the cutting units so that you don't hang them up or damage them in any way.

Don't shift the units from side to side unless the cutting units are down and the machine is moving, or the cutting units are up in the transport position. Shifting the cutting units when they are down while *not* moving may cause turf damage.

The Reelmaster is a precision mowing machine so always drive it slowly in rough areas.

If a person enters or near the operating area, stop the machine, and don't start it up again until the area is cleared. The Reelmaster is a one-person machine. Never let anyone else ride on the machine with you. This is extremely dangerous and could result in serious injury.

Accidents can happen to anyone. The most common causes are excessive speed, sudden turns, terrain (with the Reelmaster 3100-D that's knowing which slopes and hills can be mowed safely), not stopping the engine before leaving the operator's seat, and using drugs that impair your alertness. Cold capsules or prescription drugs may cause drowsiness, as can alcohol and other drugs. Stay alert and stay safe. Failure to do so could result in serious injury.

The Sidewinder offers up to a maximum of 58 cm of

overhang, allowing you to trim closer to the edge of traps and other obstacles while keeping the tractor tires as far away from the edge of traps or water hazards as possible.

If an obstacle is in the way, shift the cutting units to easily mow around it.

**CAUTION: This product may exceed noise levels of 85 dB(A) at the operator position. Ear protectors are recommended for prolonged exposure to reduce the potential of permanent hearing damage.**

When transporting the machine from one work area to another, raise the cutting units fully, move the Mow/Transport slide to the left to transport and place the throttle in the FAST position. (The cutting units will not operate in transport.)

## MOWING TECHNIQUES

To begin cutting, engage the reels, then slowly approach the mowing area. Once the front reels are over the mowing area, lower the cutting units.

To achieve the professional straight-line cut and striping that is desirable for some applications, find a tree or other object in the distance and drive straight toward it.

As soon as the front reels reach the edge of the mowing area, lift the cutting units and perform a tear drop turn to quickly line you up for your next pass.

Mowing around bunkers, ponds or other contours is easily done with The Reelmaster 3100-D with Sidewinder. To use the Sidewinder application, move the control lever left or right, depending on your mowing application. The cutting units can also be shifted to vary tire tracking.

The Reelmaster 3100-D cutting units can throw clippings to the front or rear. Front throw should be used when cutting off smaller amounts of grass; thus, leaving a better after-cut appearance. To throw clippings to the front, simply close the rear shield on the cutting units.



## CAUTION

Shut the engine off and wait for all moving parts to stop before opening or closing the cutting unit shields.

When cutting off larger amounts of grass, the shields should be positioned to just below horizontal. **Do not open the shields too far or excessive clippings can build up on the frame, rear radiator screen and the engine area.**

The cutting units are also equipped with balance weights, on the non-motor end, to give an even cut. Weights can be added or removed if mismatch occurs on your turf.

## AFTER MOWING

After mowing, thoroughly wash the machine with a garden hose—without a nozzle—so excessive water pressure will not cause contamination and damage to seals and bearings. Make sure the radiator and oil cooler are kept free of dirt or grass clippings. After cleaning, inspect the machine for possible hydraulic fluid leaks, damage or wear to hydraulic and mechanical components. Also check the cutting units for sharpness and proper reel-to-bedknife adjustment.

**IMPORTANT: After washing, move the Sidewinder mechanism (model 03201 only) from left to right several times to remove water from between the bearing blocks and cross tube.**

## SELECTING CLIP RATE (REEL SPEED)

To achieve a consistent, high quality of cut, and a uniform after-cut appearance, match the reel speed to the height of cut.

**IMPORTANT: If the reel speed is too slow, clip marks may be visible. If the reel speed is too fast the cut may have a fuzzy appearance.**

Adjust the clip rate (reel speed) as follows:

1. Verify the height-of-cut setting on the cutting units. Using the column of the chart listing either 5- or 8-

blade reels, find the height-of-cut listing nearest the actual height-of-cut setting. Look across the chart to find the number corresponding to that height of cut.

**Note:** The higher the number, the higher the speed.

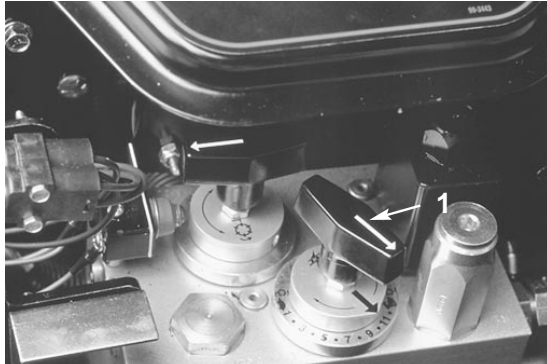

**Figure 14**

1. Reel speed control

2. Turn the reel speed control knob to the number setting determined in step 1.
3. Operate the machine for several days, then examine the cut to ensure satisfaction with the quality of cut. The reel speed knob may be set one position on either side of the position indicated on the chart to account for differences in grass condition, grass length removed and personal preference.

2-1/4	2.25	3*
2-1/8	2.13	3*
2	2.00	3*
1-7/8	1.88	3*
1-3/4	1.75	3*
1-5/8	1.63	3*
1-1/2	1.50	4
1-3/8	1.38	4
1-1/4	1.25	4
1-1/8	1.13	5
1	1.00	6
7/8	0.88	7
3/4	0.75	11
5/8	0.63	11*
1/2	0.50	11*
3/8	0.38	11*

\* This height of cut and/or mowing speed not recommended for 8-blade reels.

Note: Positions 9 to 11 give the same reel speed.

## 1 5 BLADE REEL

### REEL SPEED SELECTION CHART

2-1/2	2.50	3
2-3/8	2.38	4
2-1/4	2.25	4
2-1/8	2.13	4
2	2.00	4
1-7/8	1.88	5
1-3/4	1.75	5
1-5/8	1.63	6
1-1/2	1.50	7
1-3/8	1.38	8
1-1/4	1.25	11
1-1/8	1.13	11*
1	1.00	11*
7/8	0.88	11*
3/4	0.75	11*
5/8	0.63	11*
1/2	0.50	11*
3/8	0.38	11*

\* This height of cut and/or mowing speed not recommended for 5 blade reels.

## 8 BLADE REEL

### REEL SPEED SELECTION CHART

2-1/2	2.50	3*
2-3/8	2.38	3*

# Maintenance

## Maintenance Schedule

Maintenance Procedure	Maintenance Interval & Service				
Inspect the air filter, Dust Cup and Burp Valve Lubricate all grease fittings Change the engine oil Check battery fluid level Check battery cable connections †Check alternator fan belt tension	Every 50 hours	Every 100 hours	Every 200 hours	Every 400 hours	Every 800 hours
†Change the engine oil and filter Inspect the Traction Belt					
Replace the air filter †Replace the hydraulic filter †Torque the wheel lug nuts					
Replace the hydraulic fluid Replace the fuel/water separator filter Replace the fuel pre-filter Inspect traction cable movement Inspect the spider coupling for wear ‡Check engine RPM (idle and full throttle)					
Adjust valves					
†Initial break in at 8 hours ‡Initial break in at 50 hours					
Replace moving hoses Replace safety switches Fuel tank—drain and flush Hydraulic tank—drain and flush Cooling system—drain and flush					
					<p style="text-align: center;"><b>Recommendations</b>                      Items are recommended every 2000 hours or 2 years, whichever occurs first.</p>

## Daily Maintenance Checklist

- |                                 |                                 |
|---------------------------------|---------------------------------|
| ✓ Safety interlock operation    | ✓ Hydraulic hoses for damage    |
| ✓ Brake operation               | ✓ Fluid leaks                   |
| ✓ Engine oil & fuel level       | ✓ Fuel level                    |
| ✓ Cooling system fluid level    | ✓ Tire pressure                 |
| ✓ Drain water/fuel separator    | ✓ Instrument operations         |
| ✓ Air filter, dust cup and burp | ✓ Reel-to-bedknife adjustment   |
| ✓ Radiator & screen for debris  | ✓ Height-of-cut adjustment      |
| ✓ Unusual engine noises         | ✓ Lubricate all grease fittings |
| ✓ Unusual operating noises      | ✓ Touch-up damaged paint        |
| ✓ Hydraulic system oil level    |                                 |

## LUBRICATION

### GREASING BEARINGS AND BUSHINGS

(Fig. 15-26)

The traction unit has grease fittings that must be lubricated regularly with No. 2 General Purpose Lithium Base Grease. If you operate the machine under normal conditions, lubricate bearings and bushings after every 50 hours of operation. Bearings and bushings must be lubricated daily when operating conditions are extremely dusty and dirty. Dusty and dirty operating conditions could cause dirt to get into the bearings and bushings, resulting in accelerated wear. Lubricate bearings and bushings immediately after every washing, regardless of the interval listed.

The traction unit bearings and bushings that must be lubricated are: Rear cutting unit pivot (Fig. 15), Front cutting unit pivot (Fig. 16), Sidewinder cylinder ends (2) (Model 03201 only) (Fig. 17), Steering pivot (Fig. 18), Rear lift arm pivot and lift cylinder (2) (Fig. 19), Left front lift arm pivot and lift cylinder (2) (Fig. 20), Right front lift arm pivot and lift cylinder (2) (Fig. 21), Neutral adjust mechanism (Fig. 22), Mow/Transport slide (Fig. 23), Belt tension pivot (Fig. 24) Steering cylinder (Fig. 25).

Note: If desired, an additional grease fitting may be installed in other end of steering cylinder. Tire must be removed, fitting installed, greased, fitting removed and plug installed (Fig. 26).

**IMPORTANT: Do not lubricate Sidewinder (model 03201) cross tube, bearing blocks are self-lubricated.**



Figure 16

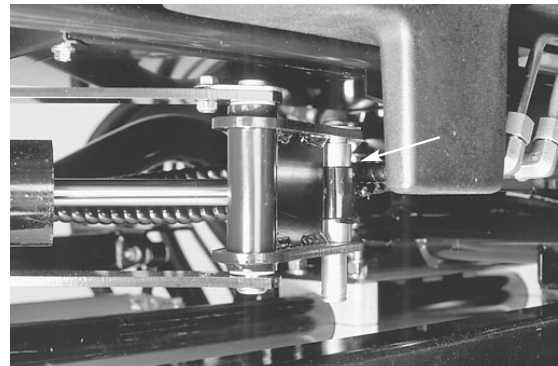

Figure 17

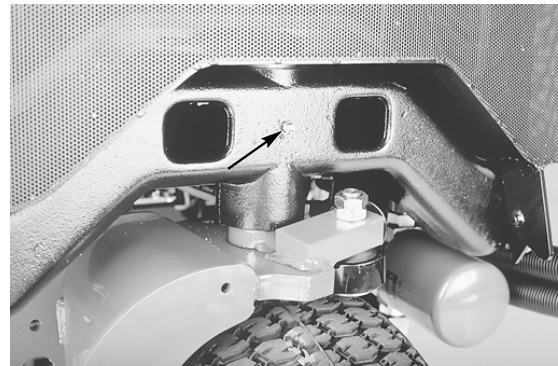

Figure 18



Figure 15

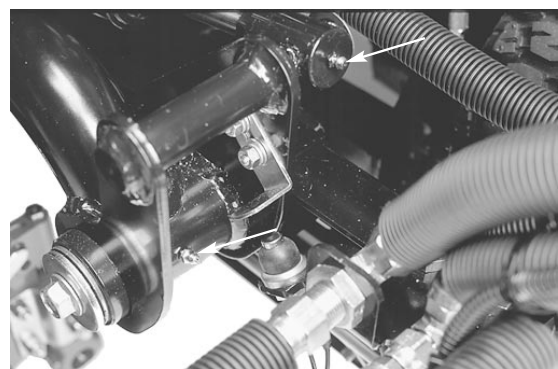

Figure 19



Figure 20

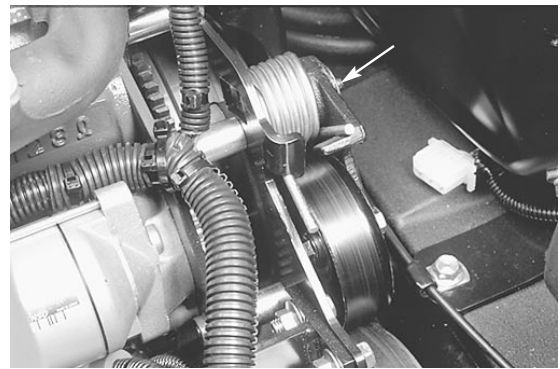

Figure 24

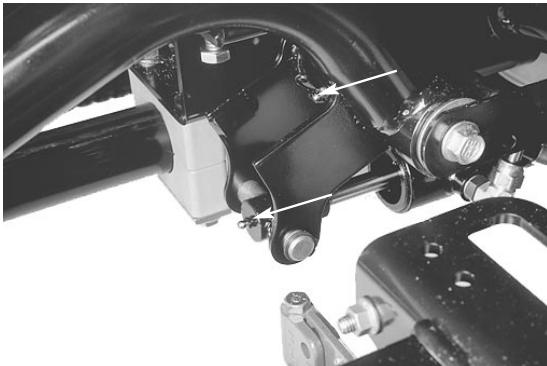

Figure 21



Figure 25



Figure 22



Figure 26

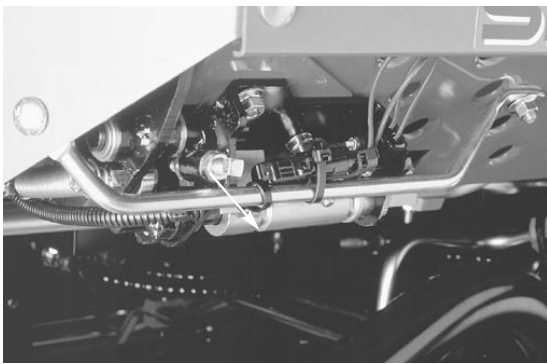

Figure 23



## CAUTION

Before servicing or making adjustments to the machine, stop the engine and remove the key from the switch.

## HOOD REMOVAL (Fig. 27)

The hood may be easily removed to ease maintenance procedures in the engine area of the machine.

1. Unlatch and raise the hood.
2. Remove the cotter pin securing the hood pivot to the mounting brackets.



**Figure 27**

1. Cotter pin

3. Slide the hood to the right side, lift the other side and pull it out of the brackets.
4. Reverse the procedure to reinstall the hood.

## AIR CLEANER MAINTENANCE

### GENERAL AIR CLEANER MAINTENANCE

1. Check the air cleaner body for damage that could possibly cause an air leak. Replace a damaged air cleaner body.
2. Service the air cleaner filter every 200 hours (more frequently in extreme dusty or dirty conditions). Do not overservice the air filter.
3. Be sure the cover seals around the air cleaner body.

## SERVICING THE AIR CLEANER (Fig. 28 & 29)

1. Release the latches securing the air cleaner cover to the air cleaner body. Separate the cover from the body. Clean the inside of the air cleaner cover.

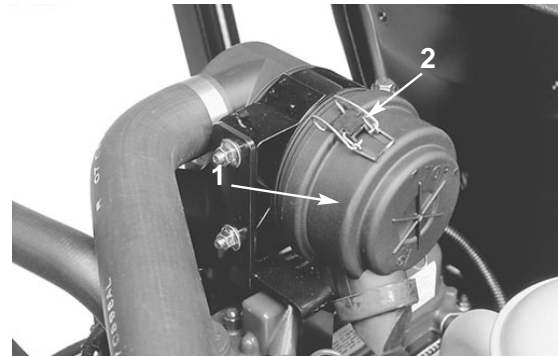

**Figure 28**

1. Air cleaner dust cup
2. Air cleaner latches

2. Gently slide the filter out of the air cleaner body to reduce the amount of dust dislodged. Avoid knocking the filter against the air cleaner body.



**Figure 29**

1. Filter element

3. Inspect the filter and discard it if it is damaged. Do not attempt to wash it.

### Washing Method

- A. Prepare a solution of the filter cleaner and water and soak the filter element about 15 minutes. Refer to directions on the filter cleaner carton for complete information.
- B. After soaking the filter for 15 minutes, rinse it



with clear water. Maximum water pressure must not exceed 276 kPa to prevent damage to the filter element. Rinse the filter from the clean side to the dirty side.

- C. Dry the filter element using warm, flowing air (71° C max), or allow the element to air dry. Do not use a light bulb to dry the filter element because damage could result.

### Compressed Air Method

- A. Blow compressed air from the inside to the outside of a dry filter element. Do not exceed 689 kPa to prevent damage to the element.
- B. Keep the air hose nozzle at least 5 cm from the filter and move the nozzle up and down while rotating the filter element. Inspect for holes and tears by looking through the filter toward a bright light.
4. Inspect the new filter for shipping damage. Check the sealing end of the filter. Do not install a damaged filter.
5. Insert the new filter into the air cleaner body. Make sure the filter is sealed properly by applying pressure to the outer rim of the filter when installing. Do not press on the flexible center of the filter.
6. Reinstall the cover and secure the latches. Make sure the cover is positioned with the TOP side up.

## ENGINE OIL AND FILTER (Fig. 30 & 31)

Change the oil and filter initially after the first 50 hours of operation; thereafter change the oil every 50 hours and the filter every 100 hours.

1. Remove the drain plug and let the oil flow into a drain pan. When the oil stops flowing, install the drain plug.
2. Remove the oil filter. Apply a light coat of clean oil to the new filter seal before screwing it on. DO NOT OVER TIGHTEN.

3. Add oil to the crankcase, refer to Check The Engine Oil.

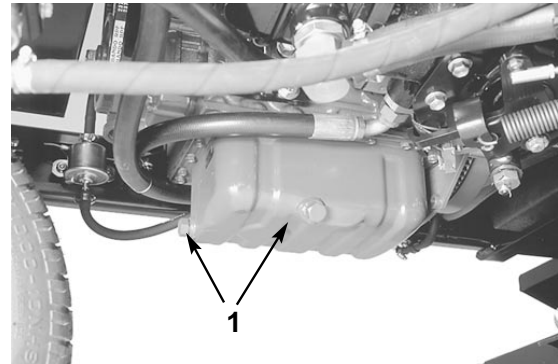

Figure 30

1. Engine Oil Drain Plug

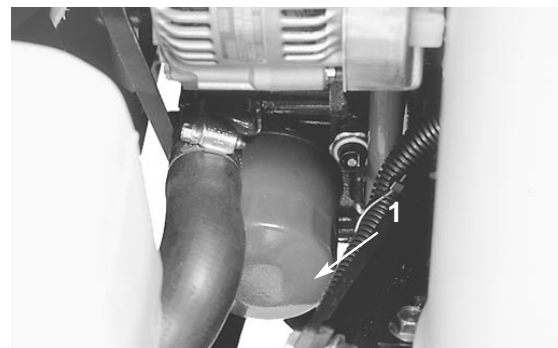

Figure 31

1. Engine Oil Filter

## FUEL SYSTEM

### Fuel Tank

Drain and clean the fuel tank every 2 years. Also, drain and clean the tank if the fuel system becomes contaminated or if the machine is to be stored for an extended period. Use clean fuel to flush out the tank.

### Fuel Lines and Connections

Check lines and connections every 400 hours or yearly, whichever comes first. Inspect for deterioration, damage, or loose connections.

### Water Separator (Fig. 32)

Drain water or other contaminants from the water

separator (Fig. 32) daily,

1. Place a clean container under the fuel filter.
2. Loosen the drain plug on the bottom of the filter canister. Tighten the plug after draining.

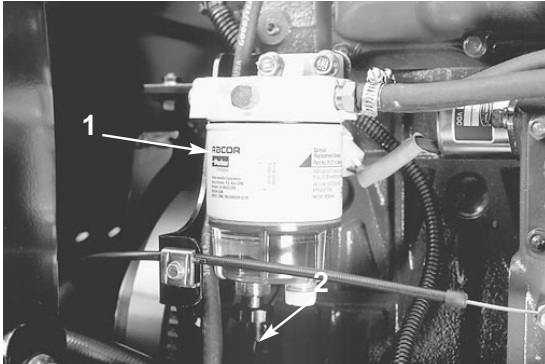

Figure 32

1. Water Separator
2. Drain Plug

Replace the filter canister after every 400 hours of operation.

1. Clean the area where the filter canister mounts.
2. Remove the filter canister and clean the mounting surface.
3. Lubricate the gasket on the filter canister with clean oil.

Install the filter canister by hand until the gasket contacts the mounting surface, then turn an additional 1/2 turn.

### Replacing the fuel Pre Filter (Fig. 33).

Replace the fuel pre filter, located on the inside of the frame rail below the water separator after every 400 operating hours or yearly, whichever occurs first.

1. Remove the screw securing the filter to the frame rail.
2. Clamp both fuel lines that connect to the fuel filter so fuel cannot drain when lines are removed.
3. Loosen the hose clamps at both ends of the filter and pull the fuel lines off the filter.

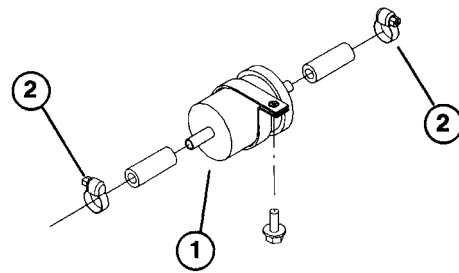

Figure 33

1. Fuel Pre Filter
2. Hose Clamps

4. Slide the hose clamps onto the ends of the fuel lines. Push the fuel lines onto the fuel filter and secure them with hose clamps. Be sure the arrow on the side of the filter points toward the injection pump.



## DANGER

Because diesel fuel is flammable, use caution when storing or handling it. Do not smoke while filling the fuel tank. Do not fill the fuel tank while the engine is running, hot, or when the machine is in an enclosed area. Always fill the fuel tank outdoors and wipe up any spilled diesel fuel before starting the engine. Store fuel in a clean, safety-approved container and keep the cap in place. Use diesel fuel for the engine only; not for any other purpose.

## BLEEDING AIR FROM INJECTORS (Fig. 34)

**Note:** This procedure should be used only if the fuel system has been purged of air through normal priming procedures and the engine will not start; refer to Bleeding The Fuel System.

1. Loosen the pipe connection to the No. 1 nozzle and holder assembly.

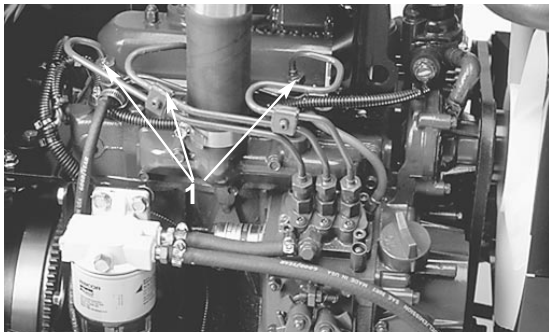
**Figure 34**

1. Fuel Injectors (3)

2. Move the throttle to the FAST position.
3. Turn the key in the key switch to the START position and watch the fuel flow around the connector. Turn the key to the OFF position when solid flow is observed.
4. Tighten the pipe connector securely.
5. Repeat the previous steps on the remaining nozzles.

## ENGINE COOLING SYSTEM (Fig. 35 & 36)

1. Removing Debris—Remove debris from the oil cooler and radiator daily; clean more frequently in dirty conditions.
  - A. Turn the engine off and raise the hood. Clean the engine area thoroughly of all debris.
  - B. Remove the access panel.

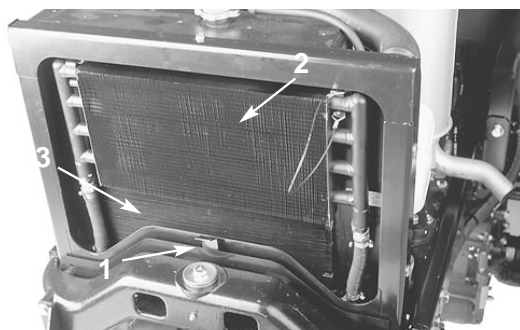
**Figure 35**

1. Access panel  
2. Oil cooler  
3. Radiator

- C. Unlatch the oil cooler and pivot it rearward. Clean both sides of the oil cooler and radiator area thoroughly with water or compressed air. Pivot the oil cooler back into position.

**Figure 36**

- D. Install access panel and close the hood.

## SERVICING THE ENGINE BELTS

Check the condition and tension of all belts after the first day of operation and every 100 operating hours thereafter.

### Alternator/fan Belt (Fig. 37)

1. Open the hood.
2. Check tension by depressing the belt midway between the alternator and crankshaft pulleys with 30 Nm of force. The belt should deflect 11 mm. If deflection is incorrect, go to step 3. If correct, continue operation.
3. Loosen the bolt securing the brace to the engine and the bolt securing the alternator to the brace.
4. Insert a pry bar between the alternator and the engine and pry outward on the alternator.
5. When correct tension is achieved, tighten the alternator and brace bolts to secure adjustment.

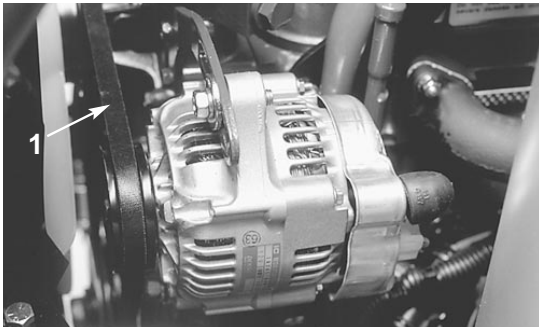

**Figure 37**

1. Alternator/tan Belt

### Hydrostat Drive Belt Replacement (Fig. 38)

1. Insert a nut driver or small piece of tubing onto the end of the belt-tensioning spring.

**WARNING**

Use caution when releasing spring tension—it is under a heavy load.

2. Push down and forward on the spring end to unhook it from the bracket and release tension on the spring.
3. Replace the belt.
4. Reverse the procedure to tension the spring.

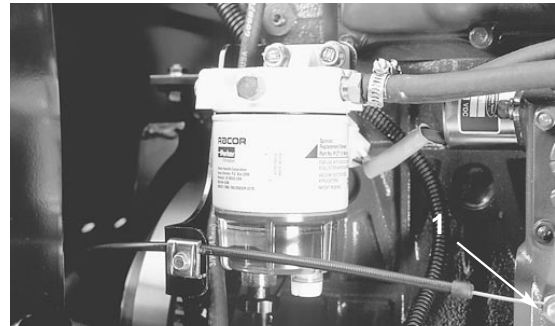

**Figure 38**

1. Hydrostat Drive Belt
2. Spring end

### ADJUSTING THE THROTTLE (Fig. 39)

1. Position the throttle lever rearward so that it stops against the control panel slot.
2. Loosen the throttle cable connector on the lever arm at the injection pump.



**Figure 39**

1. Injection Pump Lever Arm

3. Hold the injection pump lever arm against the low-idle stop and tighten the cable connector.
4. Loosen the screws securing the throttle control to the control panel.
5. Push the throttle control lever all the way forward.
6. Slide the stop plate until it contacts the throttle lever and tighten the screws securing the throttle control to the control panel.
7. If the throttle does not stay in position during operation, torque the lock nut used to set the friction device on the throttle lever. The maximum force required to operate the throttle lever should be 27 Nm.

**CAUTION**

Before servicing or making adjustments to the machine, stop the engine and remove the key from the switch.

## CHANGING HYDRAULIC FLUID (Fig. 40–42)

Change hydraulic fluid after every 400 operating hours in normal conditions. If the fluid becomes contaminated, contact your local TORO distributor because the system must be flushed. Contaminated fluid looks milky or black when compared to clean oil.

1. Turn the engine off and raise the hood.
2. Disconnect hydraulic line or remove hydraulic filter and let hydraulic fluid flow into a drain pan. Reinstall the line after hydraulic fluid stops draining.

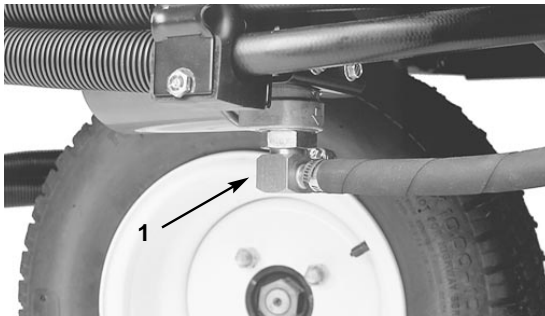

1. Hydraulic line

Figure 40

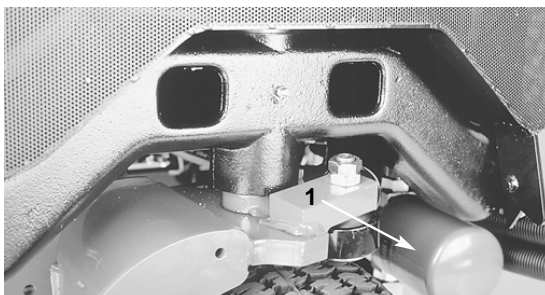

1. Hydraulic Filter

Figure 41

3. Fill the reservoir with approximately 13.2 L of hydraulic fluid. Refer to Checking Hydraulic Fluid.

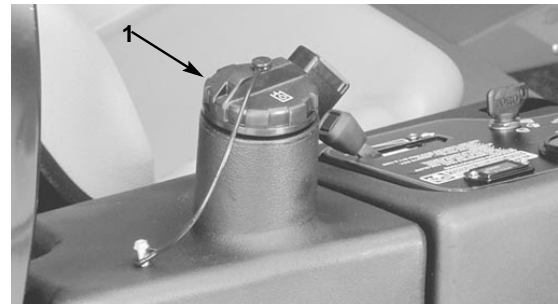

1. Hydraulic Reservoir

Figure 42

**IMPORTANT: Use only hydraulic fluids specified. Other fluids could cause system damage.**

4. Install the reservoir cap. Start the engine and use all hydraulic controls to distribute hydraulic fluid throughout the system. Also check for leaks. Then stop the engine.
5. Check the level of fluid and add enough to raise the level to the FULL mark on the dipstick. **DO NOT OVER FILL.**

## REPLACING HYDRAULIC FILTER (Fig. 43)

The hydraulic system filter must be changed initially, after the first 10 hours of operation, and thereafter every 200 hours of operation or yearly, whichever comes first. Use a genuine Toro oil filter for replacement. The hydraulic oil must be changed every 400 hours of operation or yearly, whichever comes first.

Use the Toro replacement filter (Part No. 54-0110).

**IMPORTANT: Use of any other filter may void the warranty on some components.**

1. Position the machine on a level surface, lower the cutting units, stop the engine, engage the parking brake and remove the key from the ignition switch.
2. Pinch off the hose to the filter mounting plate.
3. Clean the area around the filter mounting area. Place a drain pan under the filter and remove the filter.

4. Lubricate a new filter gasket and fill the filter with hydraulic fluid.
5. Ensure the filter mounting area is clean. Screw the filter on until the gasket contacts the mounting plate. Then tighten the filter one-half turn.
6. Start the engine and let run it for about two minutes to purge air from the system. Stop the engine and check for leaks.

## CHECKING HYDRAULIC LINES AND HOSES

Daily, check the hydraulic lines and hoses for leaks, kinked lines, loose mounting supports, wear, loose fittings, weather deterioration and chemical deterioration. Make all necessary repairs before operating.



### WARNING

Keep your body and hands away from pin hole leaks or nozzles that eject high-pressure hydraulic fluid. Use a piece of cardboard or paper to find hydraulic leaks. Hydraulic fluid escaping under pressure can penetrate skin and cause injury. Fluid accidentally injected into the skin must be surgically removed within a few hours by a doctor familiar with this form of injury or gangrene may result.

## HYDRAULIC SYSTEM TEST PORTS (Fig. 43)

The test port is used to test pressure in the hydraulic circuit. Contact your local Toro distributor for assistance.

1. Test Port #1 is used to assist in trouble shooting the forward traction hydraulic circuit.

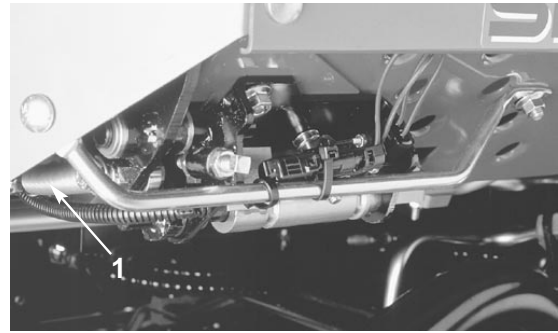

Figure 43

1. Test Port

## ADJUSTING THE TRACTION DRIVE FOR NEUTRAL (Fig. 44)

If the machine “creeps” when the traction pedal is in neutral, the traction cam must be adjusted.

1. Park the machine on a level surface and turn the engine off.
2. Raise one front wheel and rear wheel off the floor and place support blocks under the frame.



### WARNING

One front wheel and rear wheel must be raised off the ground or the machine will move during adjustment. Make sure the machine is supported so it will not accidentally fall injuring anyone under the machine.

3. Loosen the locknut on the traction adjustment cam.

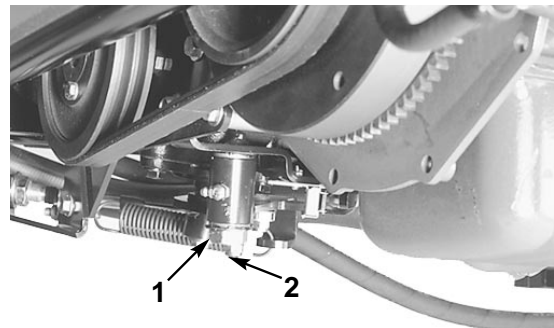

Figure 44

1. Traction adjustment cam
2. Locknut



## WARNING

The engine must be running so final adjustment of the traction adjustment cam can be performed. To guard against possible personal injury, keep hands, feet, face and other parts of the body away from the muffler, other hot parts of the engine, and other rotating parts.

4. Start the engine and turn the cam hex in both directions to determine the mid position of the neutral span.
5. Tighten the locknut securing adjustment.
6. Stop the engine.
7. Remove the support blocks and lower the machine to the shop floor. Test drive the machine to make sure it does not creep.

## BRAKE MAINTENANCE

### ADJUSTING THE PARKING BRAKE (Fig. 45)

Check adjustment every 200 hours.

1. Loosen the set screw securing the knob to the parking brake lever.
2. Turn the knob until a force of 41–54 Nm is required to actuate the lever.
3. Tighten the set screw after adjustment has been attained.

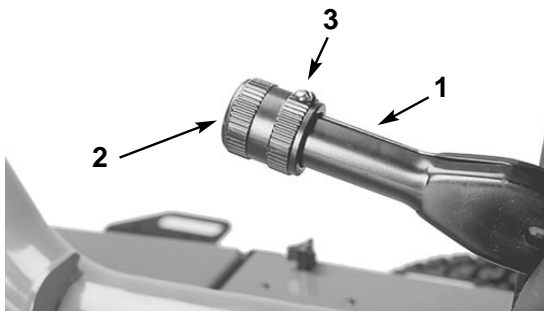

Figure 45

1. Parking brake lever
2. Knob
3. Setscrew

## BATTERY CARE

1. Battery electrolyte level must be properly maintained and the top of the battery kept clean. If the machine is stored in a location where temperatures are extremely high, the battery will run down more rapidly than if the machine is stored in a location where temperatures are cool.
2. Check the electrolyte level every 25 operating hours or, if the machine is in storage, every 30 days.
3. Maintain cell level with distilled or demineralized water. Do not fill cells above the bottom of the split ring inside each cell. Install the filler caps with their vents pointing to the rear (toward the fuel tank).



## CAUTION

Wear safety goggles and rubber gloves when working with electrolyte. Charge the battery in a well-ventilated place that so the gases produced while charging can dissipate. Since the gases are explosive, keep open flames and electrical sparks away from the battery; do not smoke. Nausea may result if the gases are inhaled. Unplug the charger from the electrical outlet before connecting to, or disconnecting, charger leads from the battery posts.

4. Keep the top of the battery clean by washing it periodically with a brush dipped in ammonia or bicarbonate of soda solution. Flush the top surface with water after cleaning. Do not remove the fill caps while cleaning.
5. Battery cables must be tight on the terminals to provide good electrical contact.



## WARNING

Connecting cables to the wrong post could result in personal injury and/or damage to the electrical system

6. If corrosion occurs at the terminals, disconnect the cables (negative (-) cable first) and scrape the clamps and terminals separately. Reconnect the

cables (positive cable first) and coat the terminals with petroleum jelly.

7. Always disconnect battery ground cable (–) first, to prevent possible wiring damage from short outs whenever working with the electrical system.

## BATTERY STORAGE

If the machine will be stored more than 30 days, remove the battery and charge it fully. Store it on the shelf on the machine. Leave the cables disconnected if stored on the machine. Store the battery in a cool atmosphere to avoid quick deterioration of the charge in the battery. To prevent battery from freezing, make sure it is fully charged. The specific gravity of a fully charged battery is 1.265–1.299.

## FUSES

The fuses in the machines electrical system are located under console cover.

## BACKLAPPING

### DANGER

#### TO AVOID PERSONAL INJURY OR DEATH:

Never place your hands or feet in the reel area while the engine is running.

- While backlapping, reels may stall and then restart.
- Do not attempt to restart the reels by hand or foot.
- Do not adjust the reels while the engine is running.
- If the reel stalls, stop the engine before attempting to clear the reel.

1. Position the machine on a clean, level surface, lower the cutting units, stop the engine, engage the parking brake and remove the key from the ignition switch.
2. Remove the console cover to expose the controls.

3. Turn the backlap knob to the backlap position. Turn the reel speed knob to position 1.

**Note:** The seat switch is bypassed when the backlap knob is in the backlap position. The operator does not need to be in the seat, but the parking brake must be engaged or the engine will not run.

### CAUTION

Do not turn the backlap knob from the mow to the backlap position while the engine is running as damage to the reels may occur.

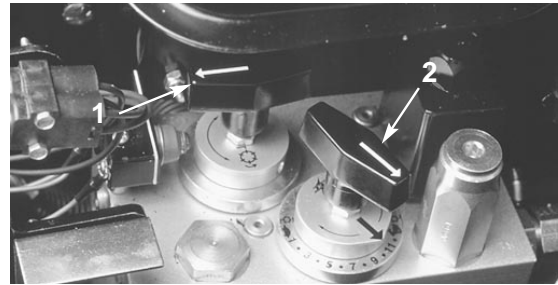

**Figure 46**

1. Backlap knob
2. Reel speed knob

4. Make initial reel-to-bedknife adjustments appropriate for backlapping on all cutting units. Start the engine and set the engine to low idle speed.
5. Engage the reels by engaging the PTO switch on the control panel.
6. Apply lapping compound with a long-handled brush.

### CAUTION

Be careful when lapping the reel because contact with the reel or other moving parts can result in personal injury.

7. To make an adjustment to the cutting units while backlapping, disengage the reels and turn the engine OFF. After adjustments have been completed, repeat steps 4–6.



8. When backlap operation is completed, stop the engine, turn the backlap knob to the MOW position, set the reel speed controls to the desired mowing setting and wash all lapping compound off the cutting units.

**NOTE:** Additional instructions and procedures on Backlapping are available in the TORO Sharpening Reel & Rotary Mowers Manual Form No. 80-300SL.

**NOTE:** For a better cutting edge, run a file across the front face of the bedknife when the lapping operation is completed. This will remove any burrs or rough edges that may have built up on the cutting edge.

## PREPARATION FOR SEASONAL STORAGE

### Traction Unit

1. Thoroughly clean the traction unit, cutting units and the engine.
2. Check the tire pressure. Inflate all tires to 97–124 kPa.
3. Check all fasteners for looseness; tighten as necessary.
4. Grease or oil all grease fittings and pivot points. Wipe up any excess lubricant.
5. Cover the entire length of the Sidewinder (Model 03201) cross tube with a light oil to prevent rust. After storage, wipe off all oil.
6. Lightly sand and use touch-up paint on painted areas that are scratched, chipped, or rusted. Repair any dents in the metal body.
7. Service the battery and cables as follows:
  - A. Remove the battery terminals from the battery posts.
  - B. Clean the battery, terminals, and posts with a wire brush and baking soda solution.
  - C. Coat the cable terminals and battery posts with

Grafo 112X skin-over grease (Toro Part No. 505-47) or petroleum jelly to prevent corrosion.

- D. Slowly recharge the battery every 60 days for 24 hours to prevent lead sulfation of the battery.

### Engine

1. Drain the engine oil from the oil pan and replace the drain plug.
2. Remove and discard the oil filter. Install a new oil filter.
3. Refill the oil pan with approximately 3.8 L of SAE 10W-30 motor oil.
4. Start the engine and run at idle speed for approximately two minutes.
5. Stop the engine.
6. Thoroughly drain all fuel from the fuel tank, lines fuel filter and water separator assembly.
7. Flush the fuel tank with fresh, clean diesel fuel.
8. Secure all fuel system fittings.
9. Thoroughly clean and service the air cleaner assembly.
10. Seal the air cleaner inlet and the exhaust outlet with weatherproof tape.
11. Check anti-freeze protection and add as needed for expected minimum temperature in your area.

## IDENTIFICATION AND ORDERING

### MODEL AND SERIAL NUMBER

The mower has two identification numbers: a model number and a serial number. The two numbers are stamped into a plate that is riveted to the frame of mower. In any correspondence concerning the mower, supply the model and serial numbers to ensure that

correct information and replacement parts are obtained.

**Note:** Do not order by reference number if a parts catalog is being used; use the part number.

To order replacement parts from an Authorized TORO Service Dealer, supply the following information:

1. Model and serial numbers of the mower.
2. Part number, description and quantity of part(s) desired.



