



Count on it.

Parts Catalog

**Reelmaster® 5010-H
Traction Unit**

Model No. 03674—Serial No. 403300001 and Up



Ordering Replacement Parts

To order replacement parts, please supply the part number, the quantity, and the description of each part desired.

Understanding Reference Numbers

Each identified part in an illustration has a reference number. The reference number for a part also appears in the parts list, along with other information about the part.

This catalog uses two special reference number formats, one to indicate parts in a service assembly and another to indicate the quantity of a given part in an illustration.

Service Assembly Reference Numbers

Parts in service assemblies have reference numbers in the form a:b. The a represents the reference number of the entire service assembly and the b represents a sequential number unique to each part within the service assembly.

For example, a wheel assembly might be identified by reference number 6, the tire by 6:1, the valve by 6:2, and the wheel by 6:3. When you order the assembly identified by reference number 6, you receive all parts identified by reference numbers 6:1, 6:2, and 6:3. However, you may also order any part individually. Reference numbers of this type appear in illustration and in parts lists.

Reference Numbers Indicating Quantity

In an illustration, if a reference number indicates more than one part, the reference number has the form nX y. The n represents the quantity of the part, the X is the multiplication symbol, and the y represents the reference number.

For example, in an illustration, the reference number 2X 37 means that two of the parts identified by reference number 37 are indicated.

Contents

Frame Assembly	5
Operator Platform and Front Shroud Assembly	6
Control Pedal Assembly	7
Steering Assembly	9
Steering Tilt Column Assembly No. 106-3622	10
Steering Valve Assembly No. 106-3621	11
Control Arm Assembly	12
Joystick Bracket Assembly No. 120-5280	14
Front Axle Assembly	15
LH Brake Assembly No. 120-6261	16
RH Brake Assembly No. 120-6260	17
Rear Axle Assembly	18
Tie Rod Assembly No. 110-5334-03	19
Hub and Spindle Assembly No. 117-8961	20
No. 1, 4 and 5 Lift Arm Assembly	21
No. 2 and 3 Lift Arm Assembly	22
Battery Mounting Assembly	23
Control Console Electrical Assembly	24
Gear Pump Assembly	25
Tandem Gear Pump Assembly No. 125-1530	26
Seat Base Assembly	27
Hood Assembly	28
Radiator Assembly	29
Fuel System Assembly	31
Hydraulic Tank Assembly	32
Seat Mounting Assembly	33
Mechanical Seat Suspension Assembly No. 110-8851	34
Traction Pump Mounting Assembly	35
Hydraulic Pump Assembly No. 119-6972	36
Traction Hydraulic Assembly	38
Hydraulic Motor Assembly No. 133-2935 (CCW)	39
Hydraulic Motor Assembly No. 133-2934 (CW)	40
Front Lift Hydraulic Assembly	41
Hydraulic Cylinder Assembly No. 119-6988	42
Hydraulic Cylinder Assembly No. 119-6987	43
Hydraulic Manifold Block Assembly No. 105-7577	44
Rear Lift Hydraulic Assembly	45
Steering Hydraulic Assembly	46
Hydraulic Cylinder Assembly No. 110-9035	48
Engine, Air Cleaner and Muffler Assembly	49
Air Cleaner Assembly No. 106-5277	51
48 Volt Battery Assembly	52
48 Volt Contactor Assembly	53
Reel Motor Plumbing Assembly	54
Main Wire Harness Assembly	55
Generator Assembly	56
Generator/Controller Assembly No. 127-2655	57
Generator Assembly No. 127-2653	58
Drive Shaft Assembly No. 125-1191	59
Crankcase Assembly	60
Oil Pan and Dipstick Assembly	61
Cylinder Head Assembly	62
Gear Case and Oil Filter Cartridge Assembly	63
Cylinder Head Cover Assembly	64

Contents (continued)

Main Bearing Case Assembly	65
Camshaft and Idle Gear Shaft Assembly	66
Piston and Crankshaft Assembly	67
Fuel Camshaft and Governor Shaft Assembly	68
Idle Apparatus Assembly	69
Injection Pump Assembly	70
Governor Assembly	71
Speed Control Plate Assembly	72
Nozzle Holder and Glow Plug Assembly	73
Nozzle Holder Assembly	74
Cover Assembly	75
Alternator, Pulley and Fan Assembly	76
Alternator Assembly No. 131-6557	77
Starter and Flywheel Assembly	78
Starter Assembly No. 131-6561	79
Water Flange and Thermostat Assembly	80
Water Pump Assembly	81
Valve and Rocker Arm Assembly	82
Inlet and Exhaust Manifold Assembly	83
Miscellaneous Engine Parts	84
Attachments and Accessories	85

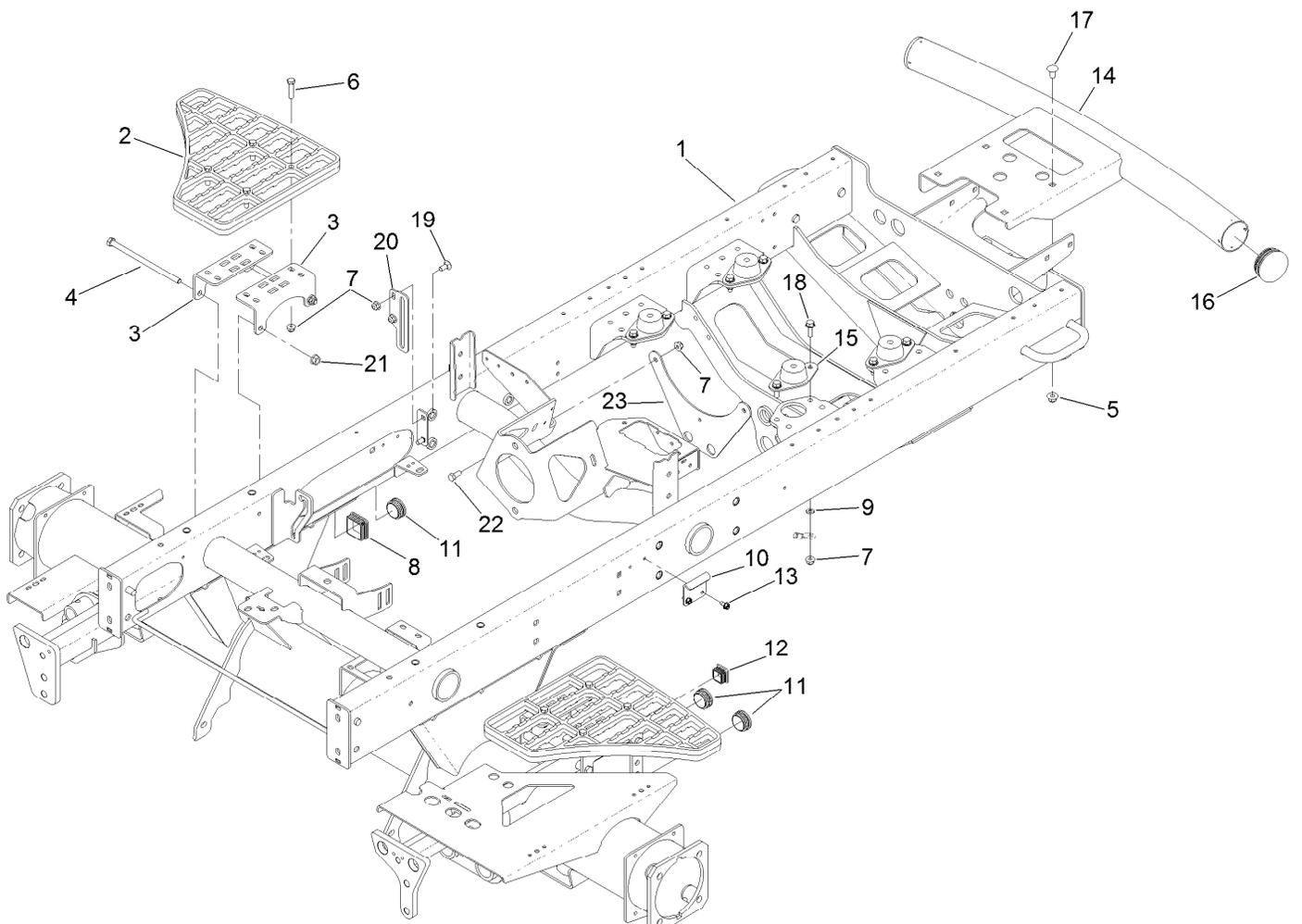

Frame Assembly

<i>Ref.</i>	<i>Part Number</i>	<i>Qty.</i>	<i>Description</i>	<i>Ref.</i>	<i>Part Number</i>	<i>Qty.</i>	<i>Description</i>
1	125-1531	1	Frame ASM	13	32104-17	2	Screw-HWH
2	110-9041	2	Step-Aluminum	14	110-8951-03	1	Bumper
3	127-2697-01	4	Bracket-Step	15	120-6274	4	Mount-Engine
4	323-36	4	Screw-HH	16	2410-42	2	Cap-End
5	104-8301	4	Nut-HF, NI	17	3231-21	4	Screw-CARR
6	322-17	8	Screw-HH	18	3234-29	8	Screw-HHF
7	104-8300	20	Nut-HF, NI	19	3230-1	2	Bolt-CARR
8	95-9495	1	Cap	20	108-7584-01	1	Plate-Guide, Rod
9	3255-8	1	Washer-Lock	21	32128-21	4	Nut-HF Lock
10	110-8972	1	Hook-Latch	22	322-3	2	Screw-HH
11	110-9012	3	Caplug	23	127-2455-01	1	Bracket-Bulkhead
12	110-9013	1	Caplug				

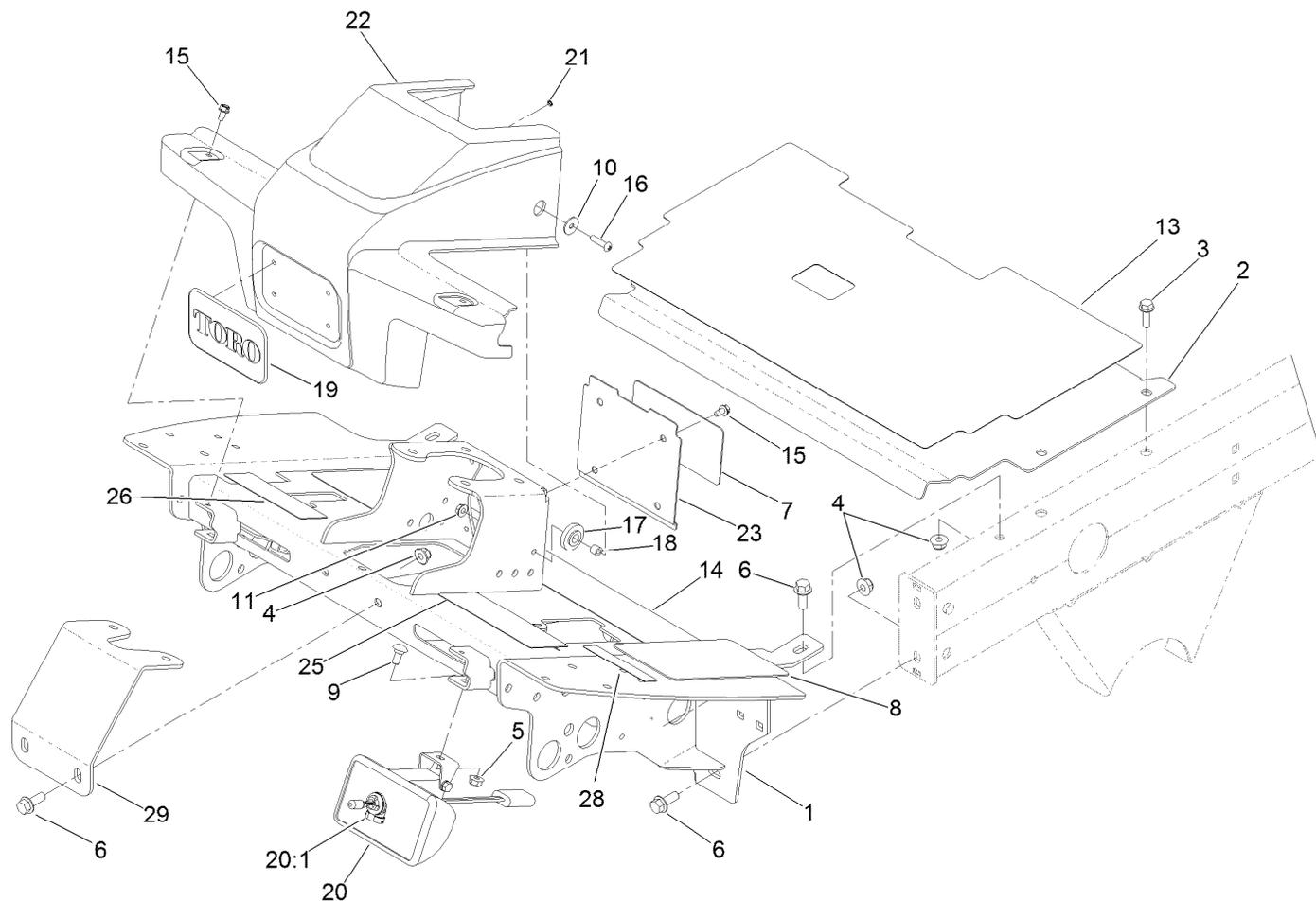

Items 20:2, 20:3 and 20:4
not used on this model.

Operator Platform and Front Shroud Assembly

Ref.	Part Number	Qty.	Description	Ref.	Part Number	Qty.	Description
1	127-2310-01	1	Platform ASM	18	66-8010	2	Spacer
2	115-8064-01	1	Plate-Floor	19	93-6028	1	Plate-Logo
3	3234-17	4	Screw-HHF	20	94-9024	2	Lamp ASM
4	104-8301	6	Nut-HF, NI	20:1	95-0909	1	Lamp-12 Volt
5	104-8300	2	Nut-HF, NI	20:2	3230-28	1	Screw-CARR
6	3234-11	6	Screw-HHF	20:3	3253-33	1	Washer-Lock
7	110-0986	1	Decal-Plate, Cover	20:4	3217-6	1	Nut-Hex
8	125-2910	2	Tread-Floor, Side	21	3254-9	4	Washer-Lock, Internal
9	3230-1	2	Bolt-CARR	22	110-0944	1	Shroud-Platform
10	87-6630	2	Washer-Plain	23	110-0947-03	1	Plate-Cover
11	32128-33	2	Nut-HF	25	133-2930	1	Decal-Danger
13	125-2911	1	Tread-Panel, Service	25	133-2931	1	Decal-Danger (CE)
14	125-2909	1	Tread-Floorboard	26	110-8921	1	Decal-Speed, Mow
15	32104-17	6	Screw-HWH	28	133-8062	1	Decal-Arrestor, Spark
16	106-9518	2	Screw-PRH	29	110-8876-01	1	Brace-Column
17	240-11	2	Bushing-Flange				

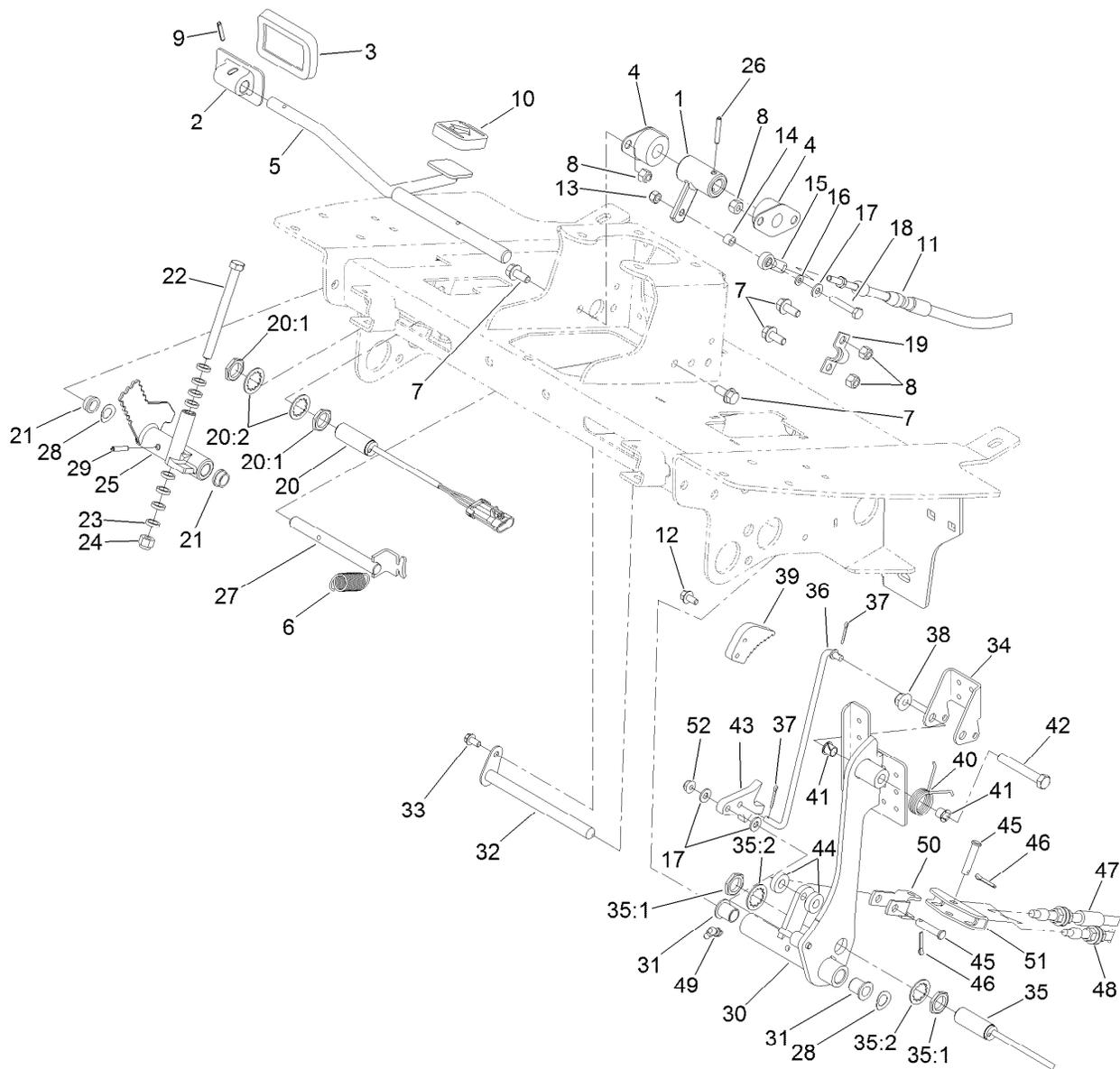

Control Pedal Assembly

Ref.	Part Number	Qty.	Description	Ref.	Part Number	Qty.	Description
1	117-5199	1	Hub-Pedal, Traction	20:2	117-3208	2	Washer-Lock, Internal Tooth
2	117-9507	1	Pedal-Accelerator	21	256-156	2	Bushing-Flange
3	74-9100	1	Pad-Pedal, Forward	22	323-17	1	Screw-HH
4	256-236	2	Bearing-Mount, Flange	23	62-4420	8	Washer
5	106-3840	1	Pedal-Traction	24	3296-39	1	Nut-Lock, NI
6	92-7305	1	Spring-Extension	25	117-8066	1	Mow-Stop
7	3234-5	6	Screw-HHF	26	32121-6	1	Pin-Roll, Slotted
8	3296-29	6	Nut-Lock, NI	27	106-3731	1	Rod-Pivot
9	32121-45	1	Pin-Spring	28	110-8982	2	Washer-Spring
10	74-9110	1	Pad-Pedal, Reverse	29	32121-16	1	Pin-Spring
11	125-1466	1	Traction Cable ASM	30	115-0120-03	1	Pedal-Brake
12	3234-13	2	Screw-HHF	31	125-8775	2	Bushing-Flange
13	3296-42	1	Nut-Lock, NI	32	104-7179	1	Pivot-Pedal
14	66-8010	1	Spacer	33	32144-4	1	Screw-HWH
15	2411-41	1	Rod End-Ball Joint	34	99-7963-03	1	Pedal-Park
16	33093-00	1	Washer-Flat	35	115-5300	1	Proximity Switch ASM
17	3256-22	3	Washer-Flat	35:1	117-3207	2	Nut-Hex
18	321-9	1	Screw-HH	35:2	117-3208	2	Washer-Lock, Internal Tooth
19	93-2092	1	Clamp-Cable	36	115-0129	1	Rod-Pawl, Brake
20	115-0282	1	Proximity Sensor ASM	37	3272-6	2	Pin-Cotter
20:1	117-3207	2	Nut-Hex	38	104-8301	1	Nut-HF, NI

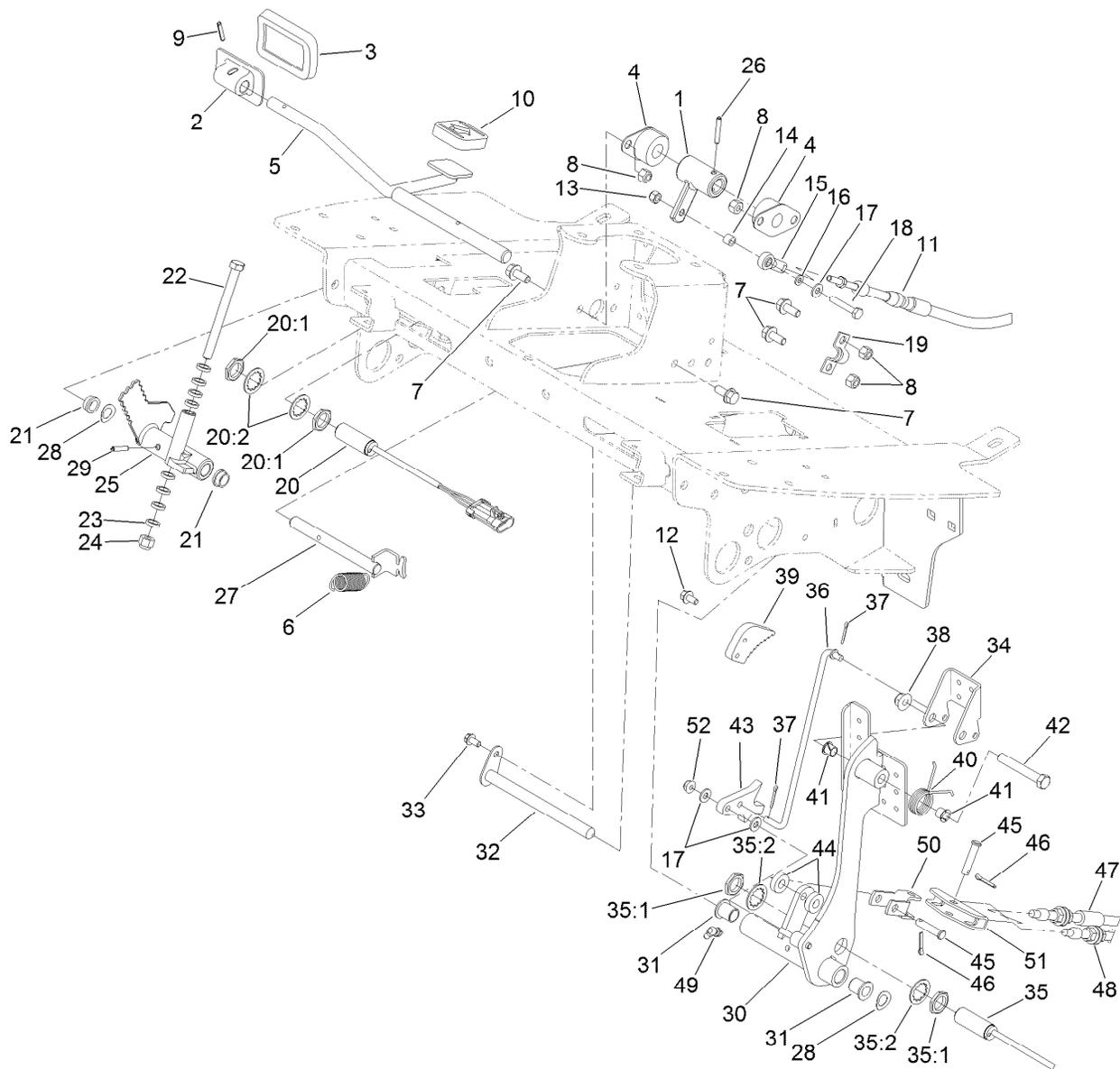

Control Pedal Assembly (continued)

<i>Ref.</i>	<i>Part Number</i>	<i>Qty.</i>	<i>Description</i>
39	99-7214	1	Pawl-Brake
40	99-7140	1	Spring-Torsion
41	52-2891	2	Bushing-Flanged, Nylon
42	323-12	1	Screw-HH
43	117-0238	1	Detent
44	5-0652	2	Spacer
45	283-14	2	Pin-Clevis

<i>Ref.</i>	<i>Part Number</i>	<i>Qty.</i>	<i>Description</i>
46	3272-10	2	Pin-Cotter
47	117-0106	1	Cable-Brake, RH
48	117-0107	1	Cable-Brake, LH
49	302-60	1	Fitting-Grease
50	115-8060	1	Clevis-Double
51	115-8059	1	Yoke-Cable
52	104-7201	1	Nut-HF, NI

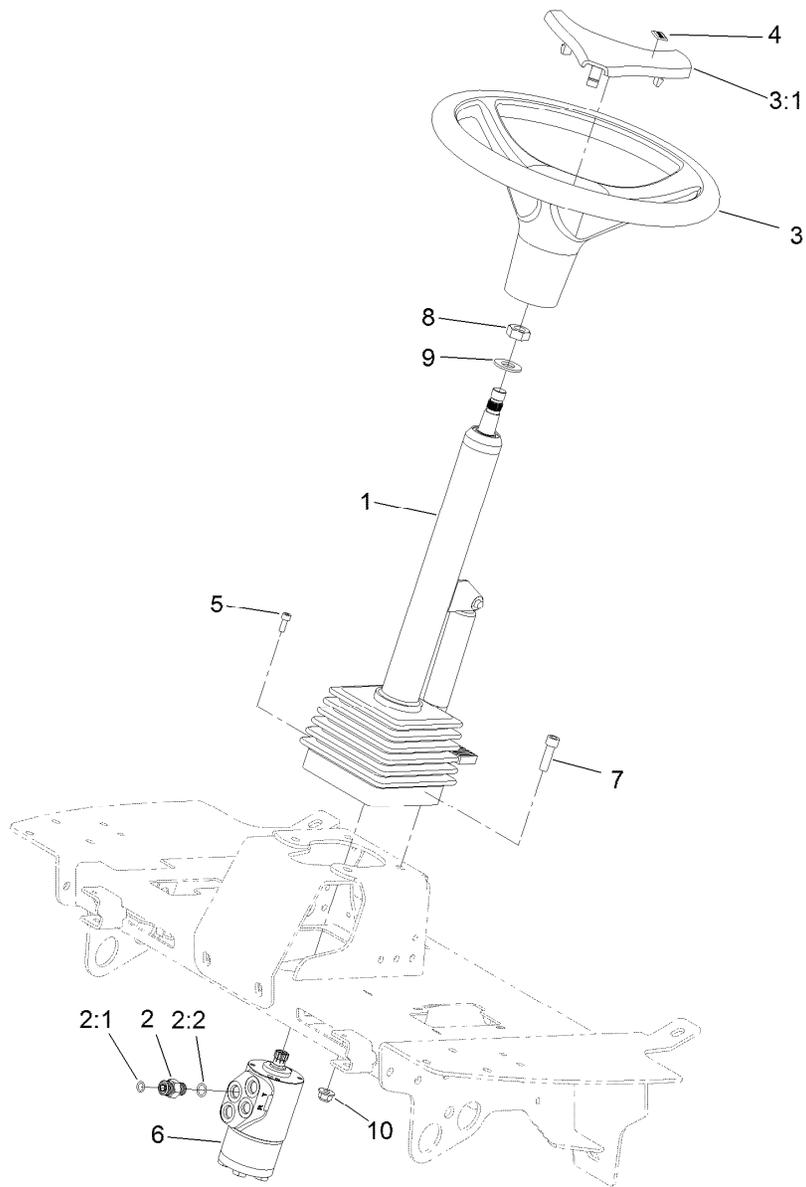

Steering Assembly

Ref.	Part Number	Qty.	Description
1	106-3622	1	Steering Tilt Column ASM
2	340-2	4	Fitting-Straight
2:1	237-22	1	O-Ring
2:2	237-42	1	O-Ring
3	98-1471	1	Wheel-Steering
3:1	98-1468	1	Cover-Wheel, Steering
4	98-1459	1	Decal
5	105-2409	4	Screw-HSH
6	106-3621	1	Steering Valve ASM
7	3274-1	4	Screw-HSH
8	3296-33	1	Nut-Lock, NI
9	3256-27	1	Washer-Flat
10	104-8301	4	Nut-HF, NI

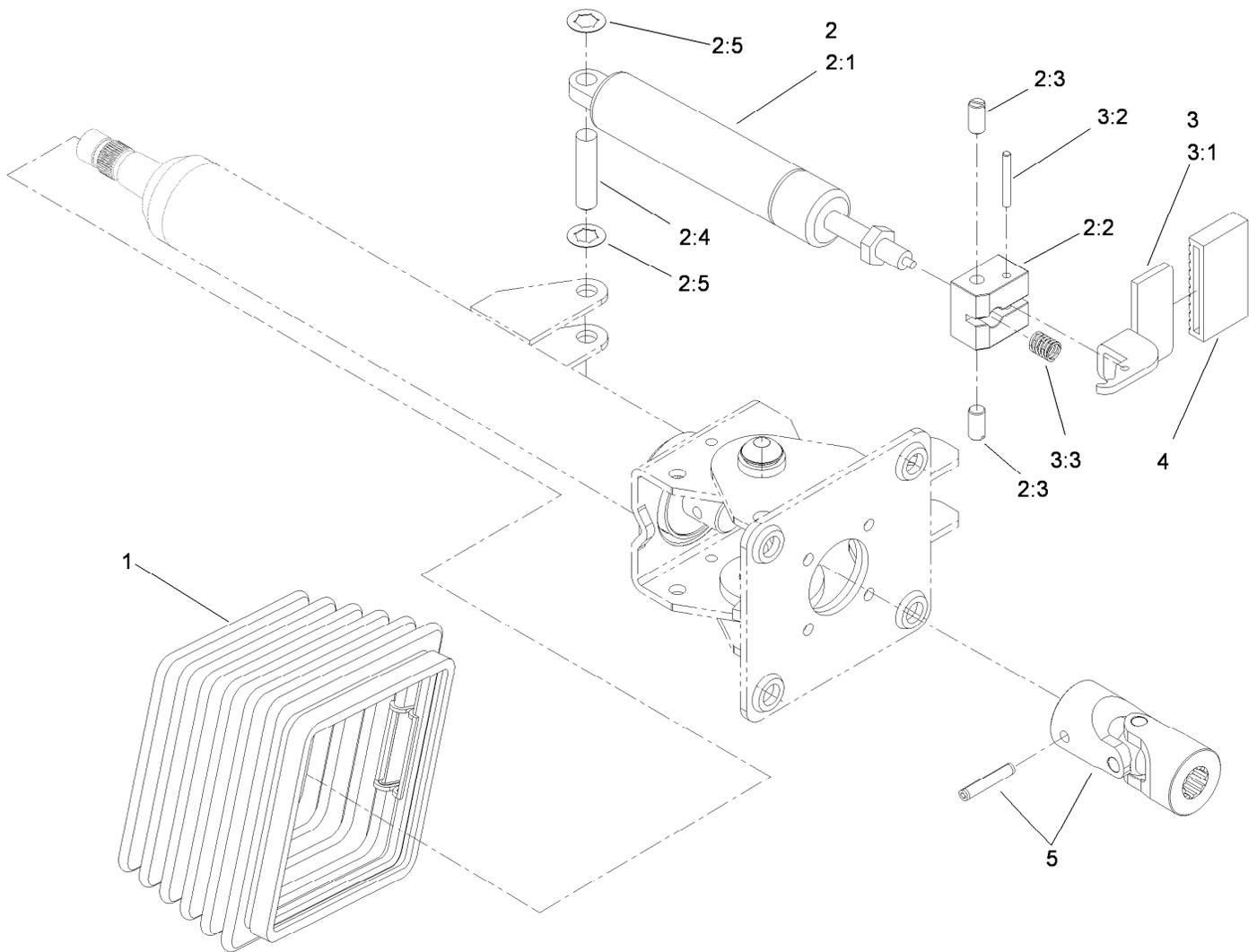

Steering Tilt Column Assembly No. 106-3622

Ref.	Part Number	Qty.	Description
1	110-6462	1	Bellows-Rubber
2	110-6463	1	Cylinder Service Kit
2:1		1	Cylinder-Gas ●
2:2		1	Block-Pedal ●
2:3		2	Bolt ●
2:4		1	Pin ●
2:5		2	Washer-Lock ●
3	110-6464	1	Pedal Service Kit
3:1		1	Pedal ●
3:2		1	Pin ●
3:3		1	Spring ●
4	110-6465	1	Cover-Pedal
5	120-6256	1	Universal Joint Kit

● Not serviced separately

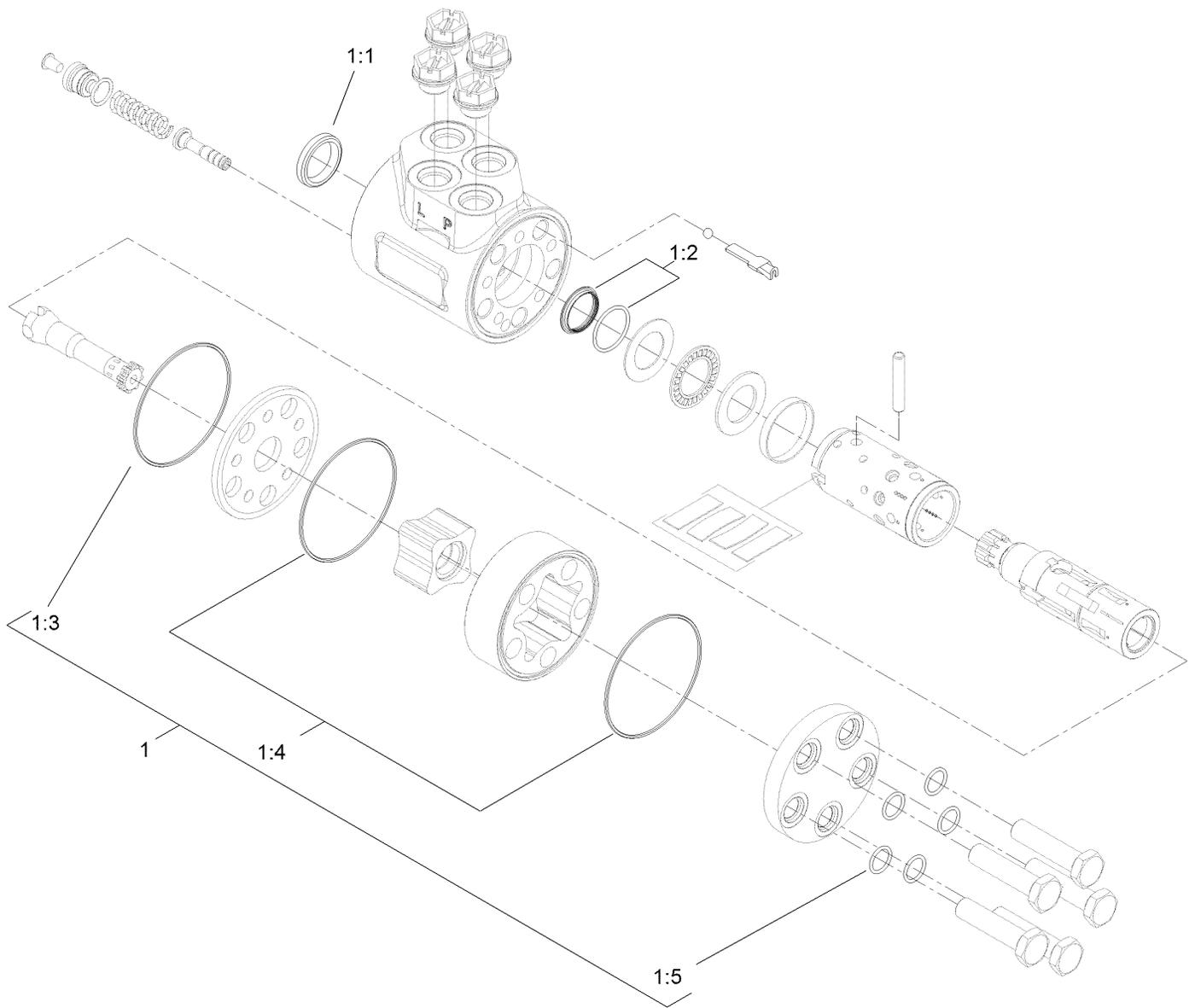

Steering Valve Assembly No. 106-3621

<i>Ref.</i>	<i>Part Number</i>	<i>Qty.</i>	<i>Description</i>
1	106-6716	1	Seal Kit
1:1		1	Ring-Seal, Dust ●
1:2		1	Seal-Shaft ●
1:3		1	O-Ring ●
1:4		2	O-Ring ●
1:5		5	O-Ring ●

● Not serviced separately

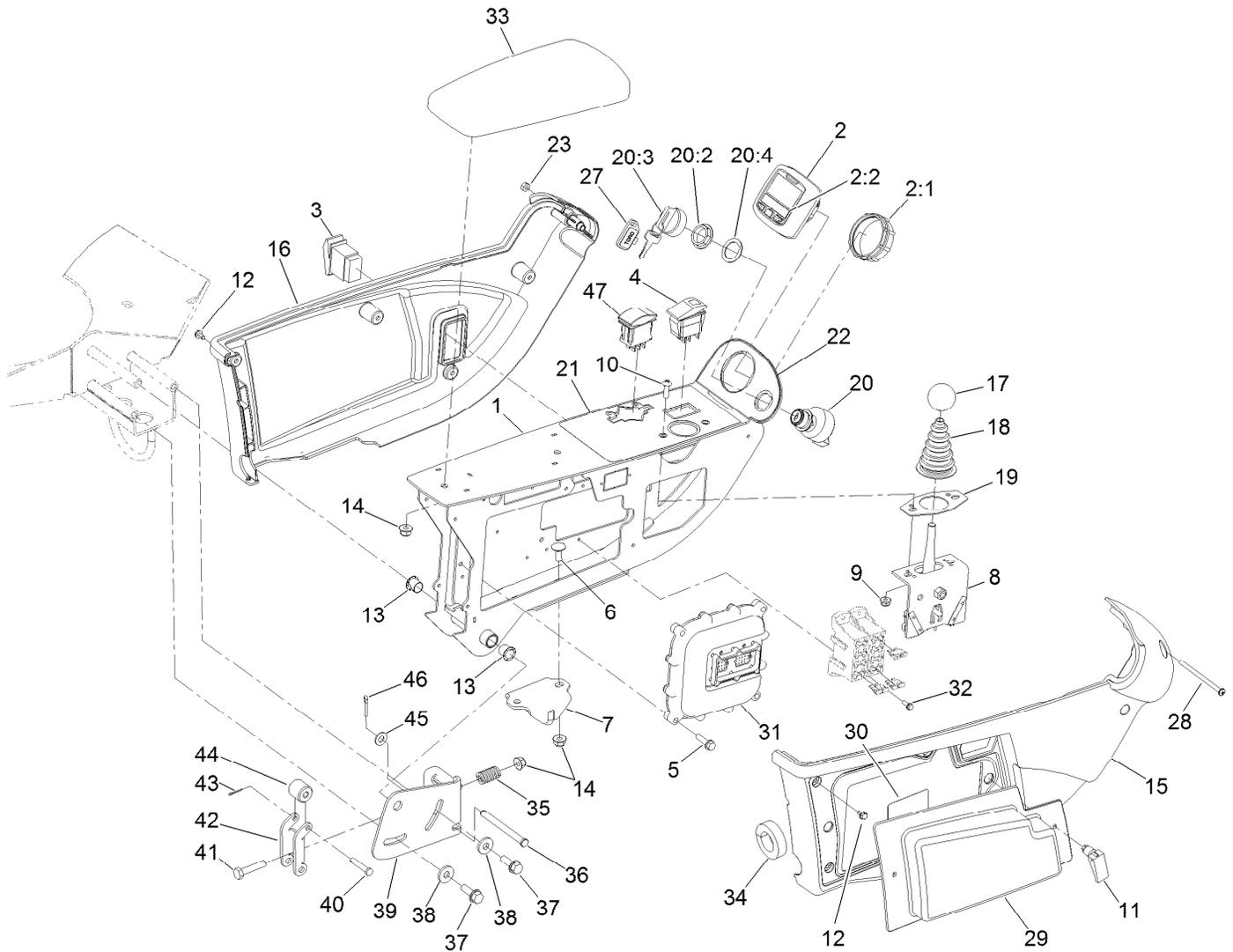

Control Arm Assembly

Ref.	Part Number	Qty.	Description	Ref.	Part Number	Qty.	Description
1	120-3801-03	1	Frame-Arm, Control	20	106-5269	1	Ignition Switch ASM
2	120-6310	1	LCD Display ASM	20:2	108-8660	1	Nut-Mounting
2:1	120-4630	1	Nut-Display	20:3	106-5270	1	Ignition Key Set
2:2	120-6311	1	Decal-Display	20:4	108-8659	1	Washer-Backup
3	95-8999	1	Switch	21	125-8754	1	Decal-Panel, Control
4	105-4232	1	Switch	22	120-4158	1	Decal-Console, Upper
5	32144-86	4	Screw-HWHTF	23	3296-2	1	Nut-Lock, NI
6	3230-23	2	Bolt-CARR	27	99-8970	1	Key-Latch, Hood
7	125-1938	1	Latch	28	3250-22	1	Screw-PPH
8	120-5280	1	Bracket-Joystick	29	114-0446	1	Panel-Access
9	104-7201	2	Nut-HF, NI	30	117-0169	1	Decal-Fuses
10	3258-166	2	Screw-PRH	31	114-3321	1	Controller-Tec
11	74-5950	2	Latch-Swell	32	32144-87	4	Screw-HWHTF
12	104-2065	10	Screw-HWH	33	108-7602	1	Rest-Arm
13	256-257	2	Bushing-Nyliner	34	110-8912	1	Seal-Foam
14	104-8300	5	Nut-HF, NI	35	110-5331	1	Spring-Compression
15	108-7605	1	Cover-RH	36	283-88	1	Pin-Clevis
16	108-7604	1	Cover-LH	37	32144-41	2	Screw-Taptite
17	233-42	1	Knob	38	4-2390	2	Washer-Flat
18	93-5961	1	Boot-Lever	39	110-5313-03	1	Bracket-Retainer
19	112-9181	1	Plate-Boot	40	283-73	1	Pin-Clevis

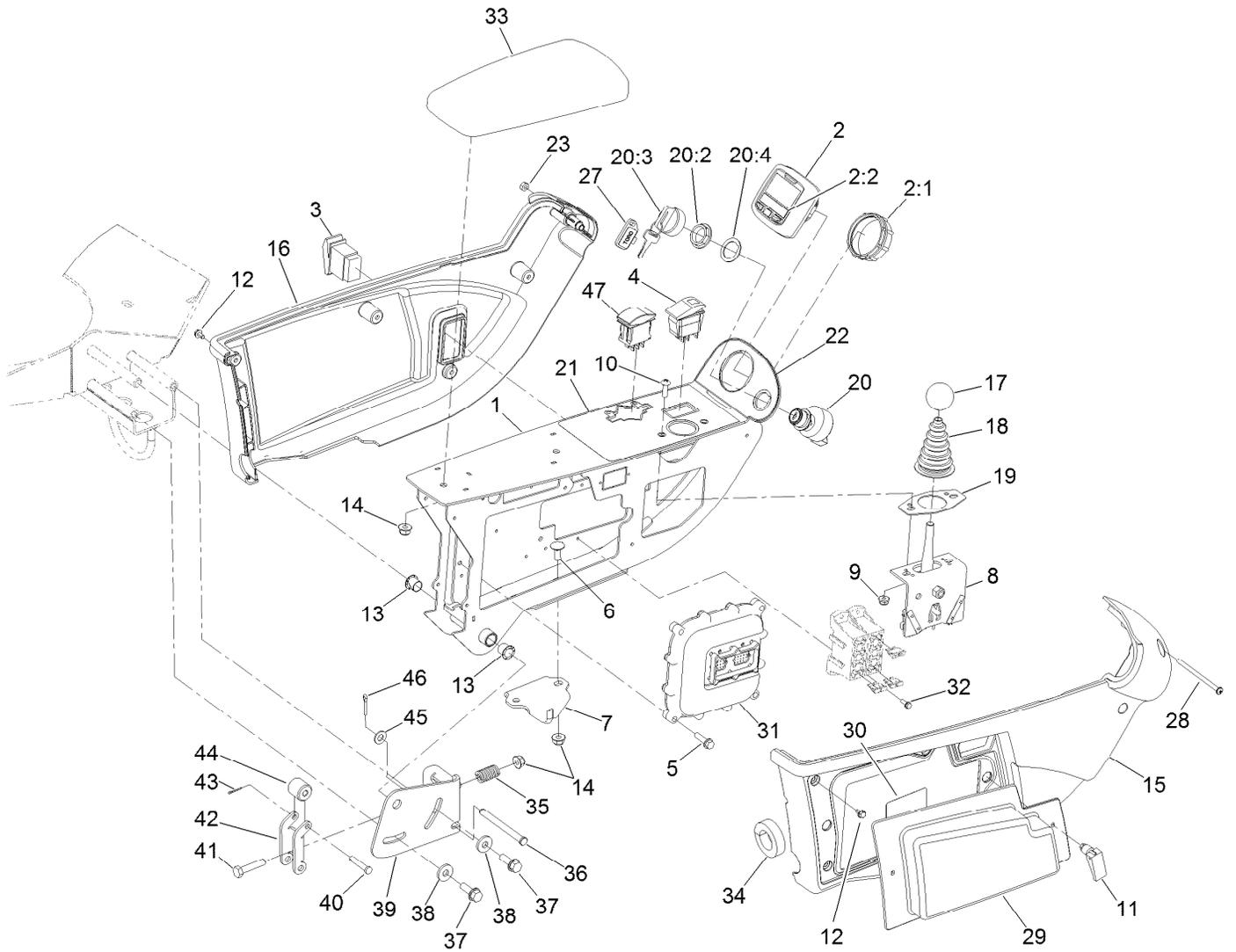

Control Arm Assembly (continued)

Ref.	Part Number	Qty.	Description
41	322-7	1	Screw-HH
42	110-5314	1	Latch
43	3272-1	1	Pin-Cotter
44	110-8856	1	Spacer

Ref.	Part Number	Qty.	Description
45	3256-23	1	Washer-Plain
46	3272-10	1	Pin-Cotter
47	100-1535	1	Switch-Rocker, (On)-Off-(On)

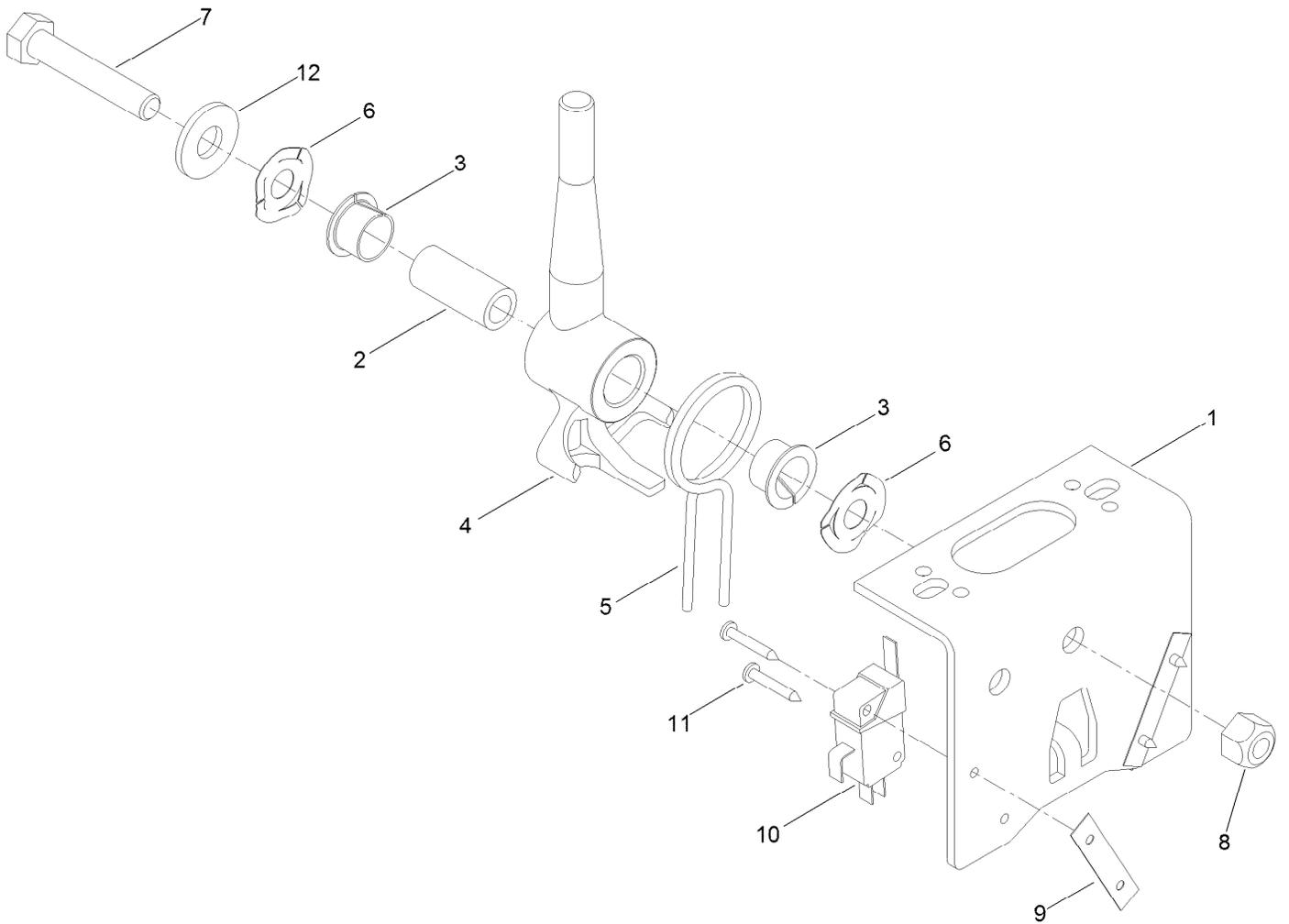

Joystick Bracket Assembly No. 120-5280

<i>Ref.</i>	<i>Part Number</i>	<i>Qty.</i>	<i>Description</i>
1	115-5357-03	1	Bracket-Joystick
2	106-4192	1	Spacer
3	93-5547	2	Bushing-Nylon
4	119-3540	1	Hub-Pivot, Joystick
5	105-8289	1	Spring-Torsion
6	106-4193	2	Washer-Finger, Spring
7	322-9	1	Screw-HH
8	3296-29	1	Nut-Lock, NI
9	3290-354	2	Nut-Speed
10	108-6496	2	Switch (W/Boot)
11	95-3003	4	Screw-PPHTF
12	3256-3	1	Washer-Flat

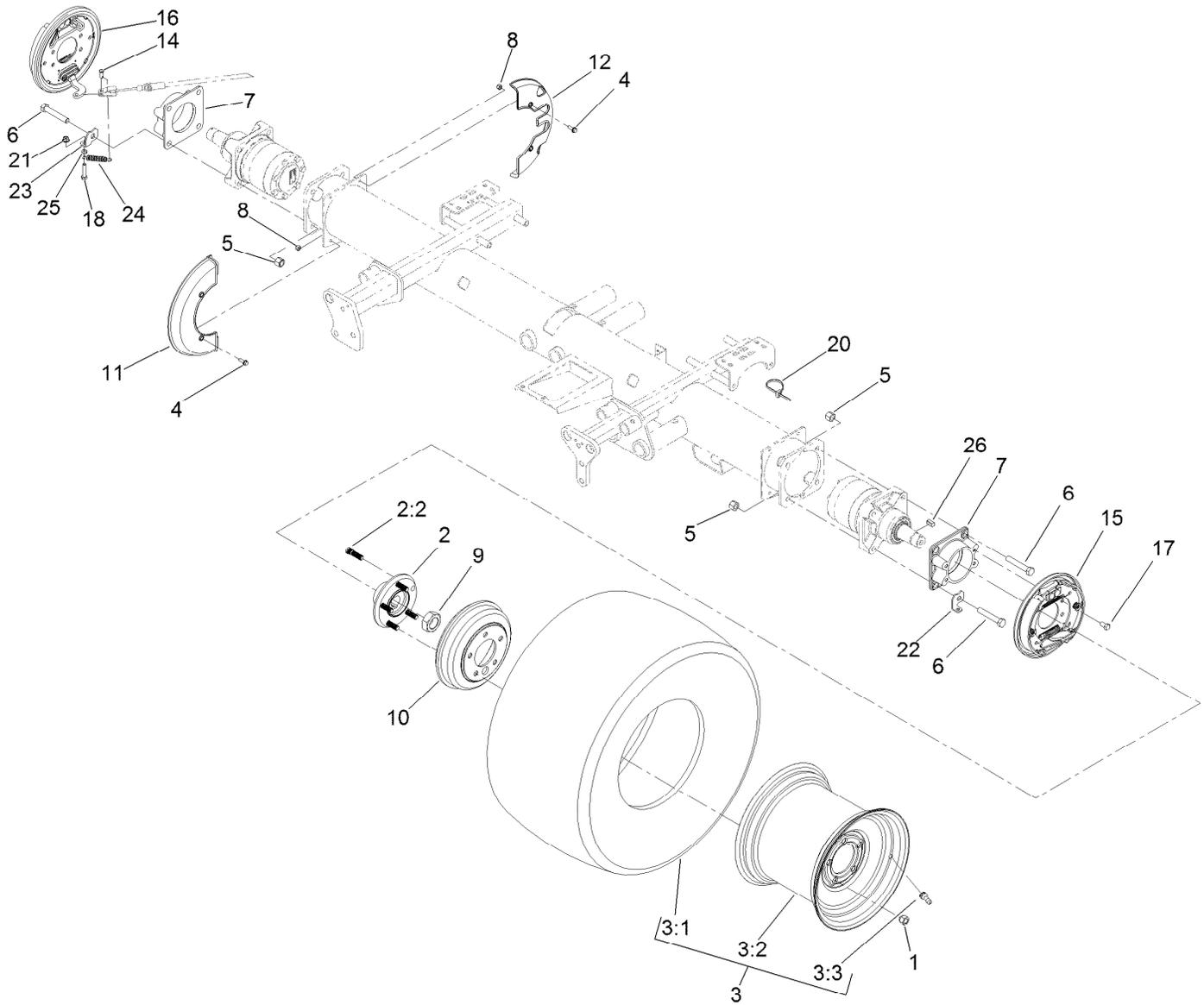

Front Axle Assembly

Ref.	Part Number	Qty.	Description	Ref.	Part Number	Qty.	Description
1	242-50	10	Nut-Lug	11	127-2741	2	Shield-Wheel, Front
2	121-5631	2	Hub ASM	12	127-2742	2	Shield-Wheel, Rear
2:2	114-3918	5	Stud-Wheel	14	283-62	2	Pin-Clevis
3	136-7963	2	Tire ASM	15	120-6261	1	LH Brake ASM
3:1	117-5196	1	Tire	16	120-6260	1	RH Brake ASM
3:2	136-7964	1	Wheel	17	323-4	8	Screw-HH
3:3	232-27	1	Stem-Valve	18	322-7	2	Screw-HH
4	115-5103	8	Screw-HHF	20	3290-378	2	Tie-Cable
5	3296-23	8	Nut-Lock, NI	21	104-8300	2	Nut-HF, NI
6	325-12	8	Screw-HH	22	120-6267	1	Clip-Spring, LH
7	120-6253-03	2	Adapter-Brake	23	120-6266	1	Clip-Spring, RH
8	3296-42	8	Nut-Lock, NI	24	87-4020	2	Spring-Extension
9	117-3290	2	Nut-Hex	25	3218-2	2	Nut-Hex Jam
10	114-8864	2	Drum-Brake	26	117-5198	2	Key-Square

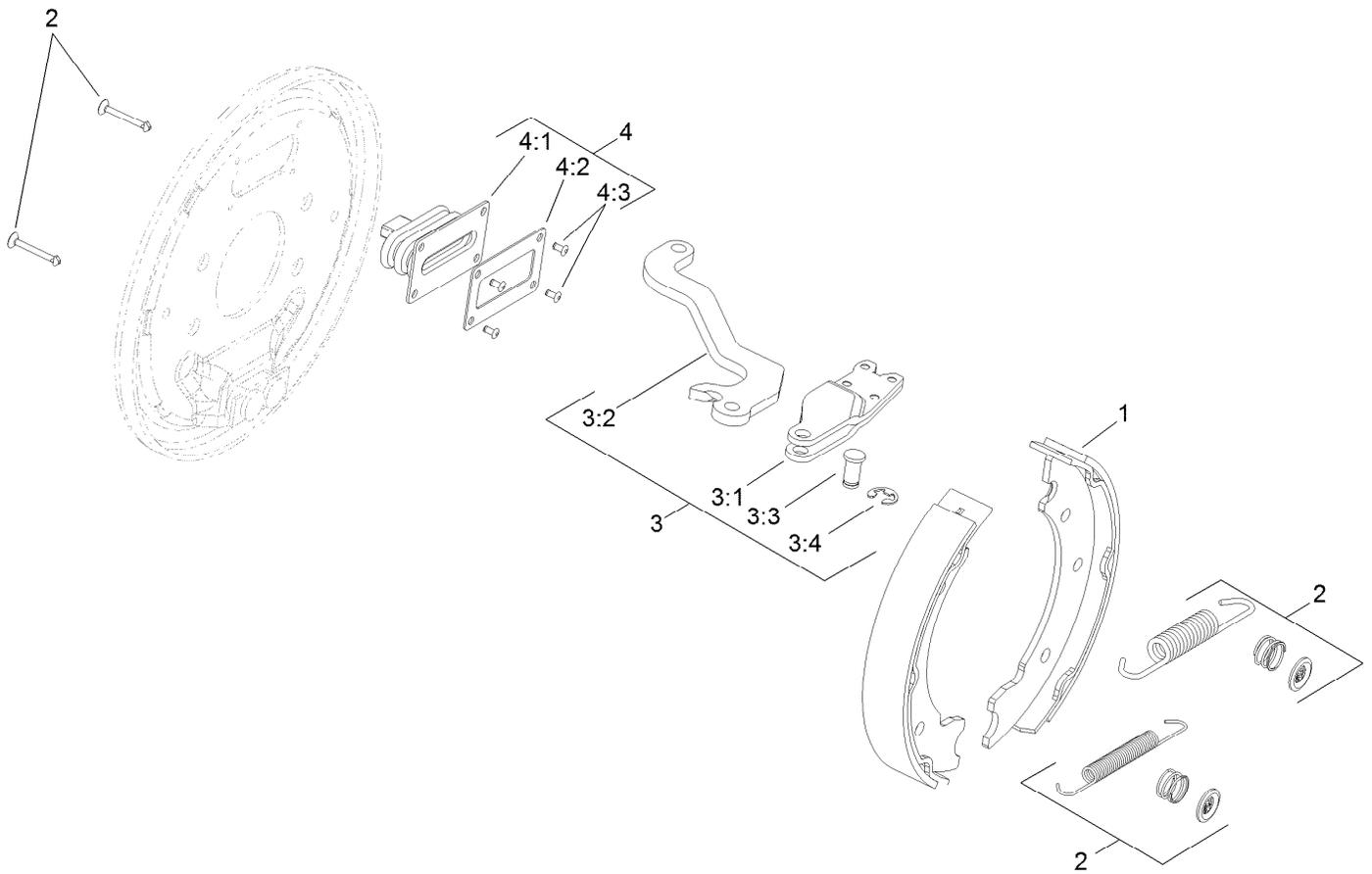

LH Brake Assembly No. 120-6261

Ref.	Part Number	Qty.	Description
1	108-6981	1	Brake Shoe Kit
2	108-6983	1	Brake Hardware Kit
3	110-8910	1	LH Actuator Kit
3:1		1	Housing ●
3:2		1	Lever-LH ●
3:3		1	Pin-Pivot ●
3:4		1	E-Ring ●
4	110-8885	1	Dust Boot Kit
4:1		1	Boot ●
4:2		1	Plate-Back Up ●
4:3		2	Rivet ●

● Not serviced separately

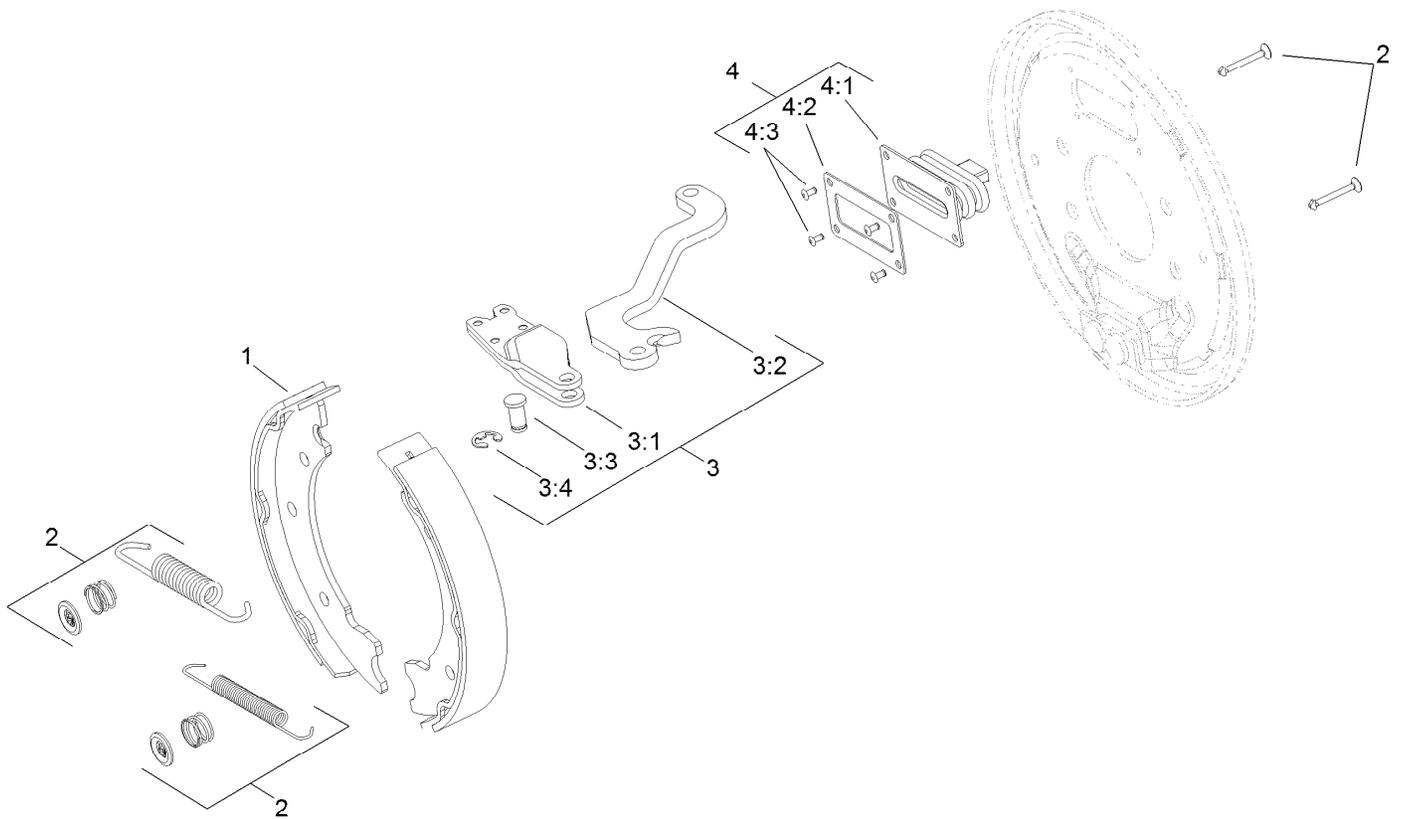

RH Brake Assembly No. 120-6260

Ref.	Part Number	Qty.	Description
1	108-6981	1	Brake Shoe Kit
2	108-6983	1	Brake Hardware Kit
3	110-8884	1	RH Actuator Kit
3:1		1	Housing ●
3:2		1	Lever-RH ●
3:3		1	Pin-Pivot ●
3:4		1	E-Ring ●
4	110-8885	1	Dust Boot Kit
4:1		1	Boot ●
4:2		1	Plate-Back Up ●
4:3		2	Rivet ●

● Not serviced separately

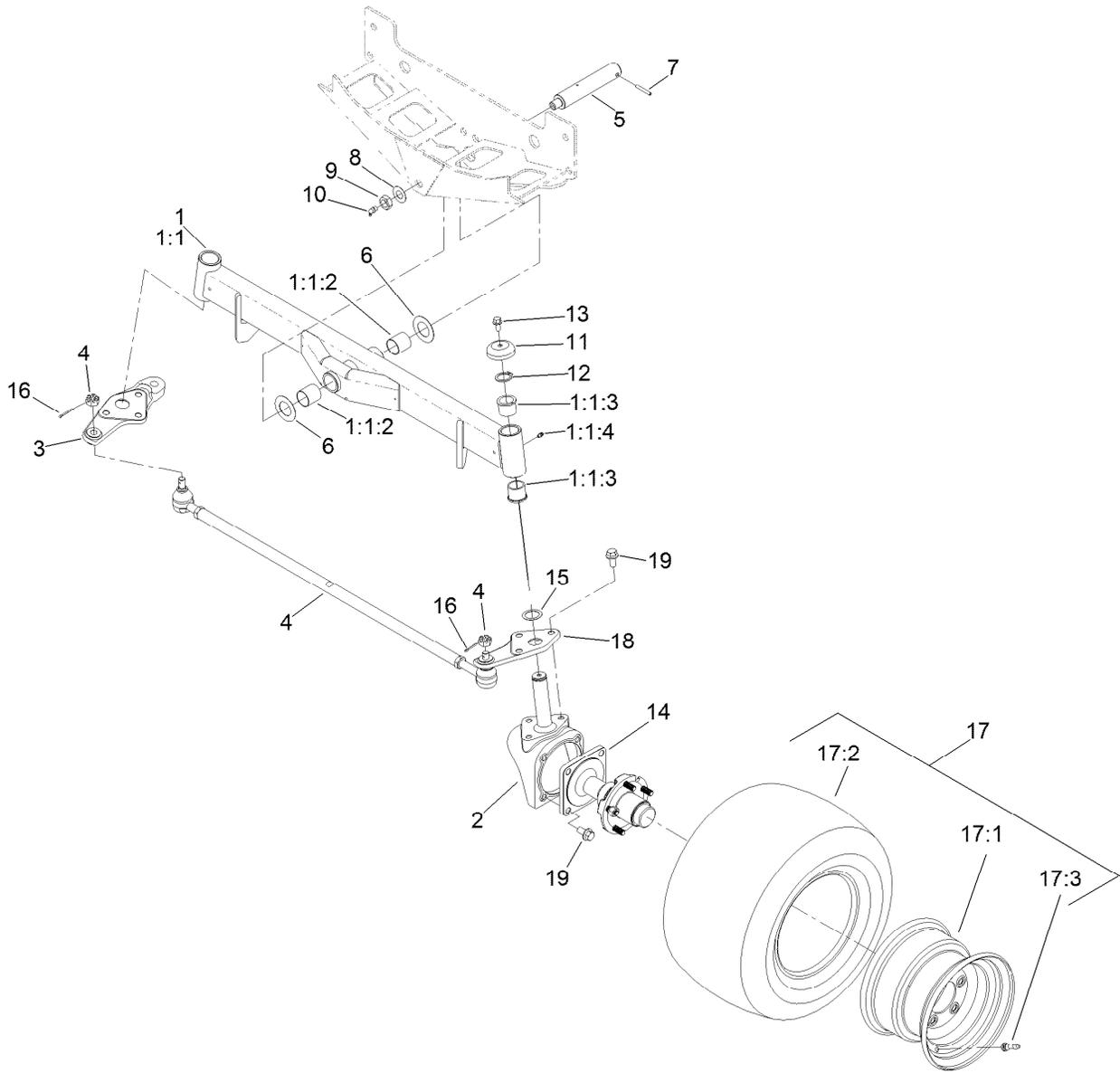

Rear Axle Assembly

Ref.	Part Number	Qty.	Description	Ref.	Part Number	Qty.	Description
1	107-4546-03	1	Axle ASM	10	302-33	1	Fitting-Grease
1:1		1	Axle ●	11	69-8890	2	Cap-Spindle
1:1:2	99-6964	2	Bushing-Axle	12	32151-77	2	Ring-Retaining, External
1:1:3	104-0015	4	Bushing-Flange	13	3234-1	2	Screw-HHF
1:1:4	302-5	2	Fitting-Grease	14	117-8961	2	Hub And Spindle ASM
2	107-4517-03	2	Housing-Motor	15	76-2980	2	Washer-Thrust
3	110-5295-03	1	Link-Drag, RH	16	3272-12	2	Pin-Cotter
4	110-5334-03	1	Tie Rod ASM	17	117-0281	2	Rim And Tire ASM
5	98-8173	1	Pin-Pivot, Axle	17:1	117-0280	1	Rim
6	99-8432	2	Washer-Thrust	17:2	117-5125	1	Tire
7	32121-32	1	Pin-Roll	17:3	232-27	1	Stem-Valve
8	71-4540	1	Washer-Thrust	18	110-5297-03	1	Link-Drag, LH
9	3296-15	1	Nut-Lock, NI	19	3234-6	14	Screw-HHF

● Not serviced separately

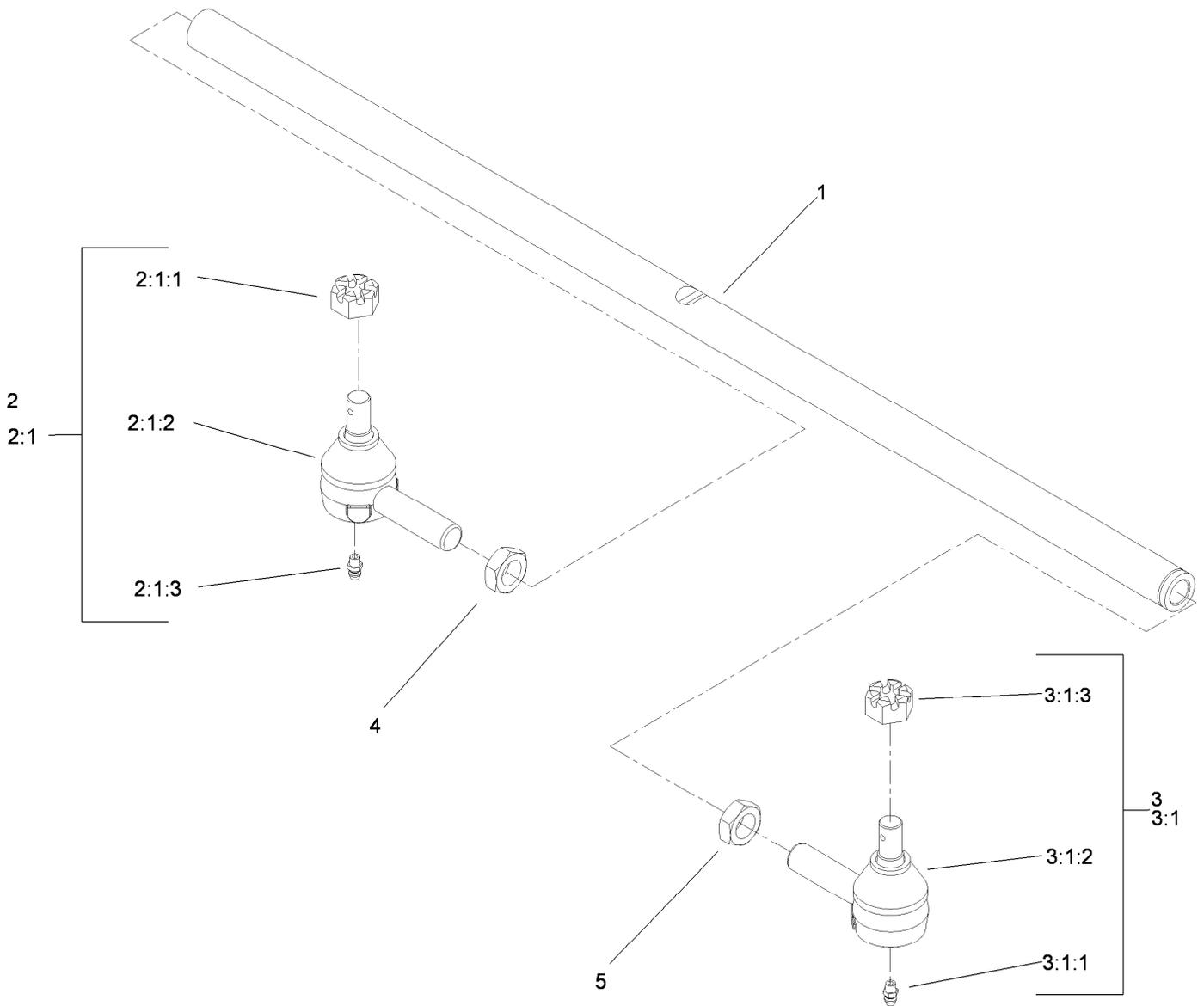

Tie Rod Assembly No. 110-5334-03

Ref.	Part Number	Qty.	Description
1	110-5335	1	Rod-Tie
2	71-4740-03	1	RH Tie Rod End ASM
2:1		1	End-Rod, Tie (RH) ■
2:1:1	105-7941	1	Nut-Hex, Slotted
2:1:2	105-7835	1	Seal
2:1:3	302-5	1	Fitting-Grease
3	2411-46-03	1	LH Tie Rod ASM
3:1		1	End-Rod, Tie (LH) ● ■
3:1:1	302-5	1	Fitting-Grease ●
3:1:2	105-7835	1	Seal ●
3:1:3	105-7941	1	Nut-Hex, Slotted ●
4	84-5300	1	Nut-Jam
5	110-5337	1	Nut-Jam

● Not illustrated

■ Not serviced separately

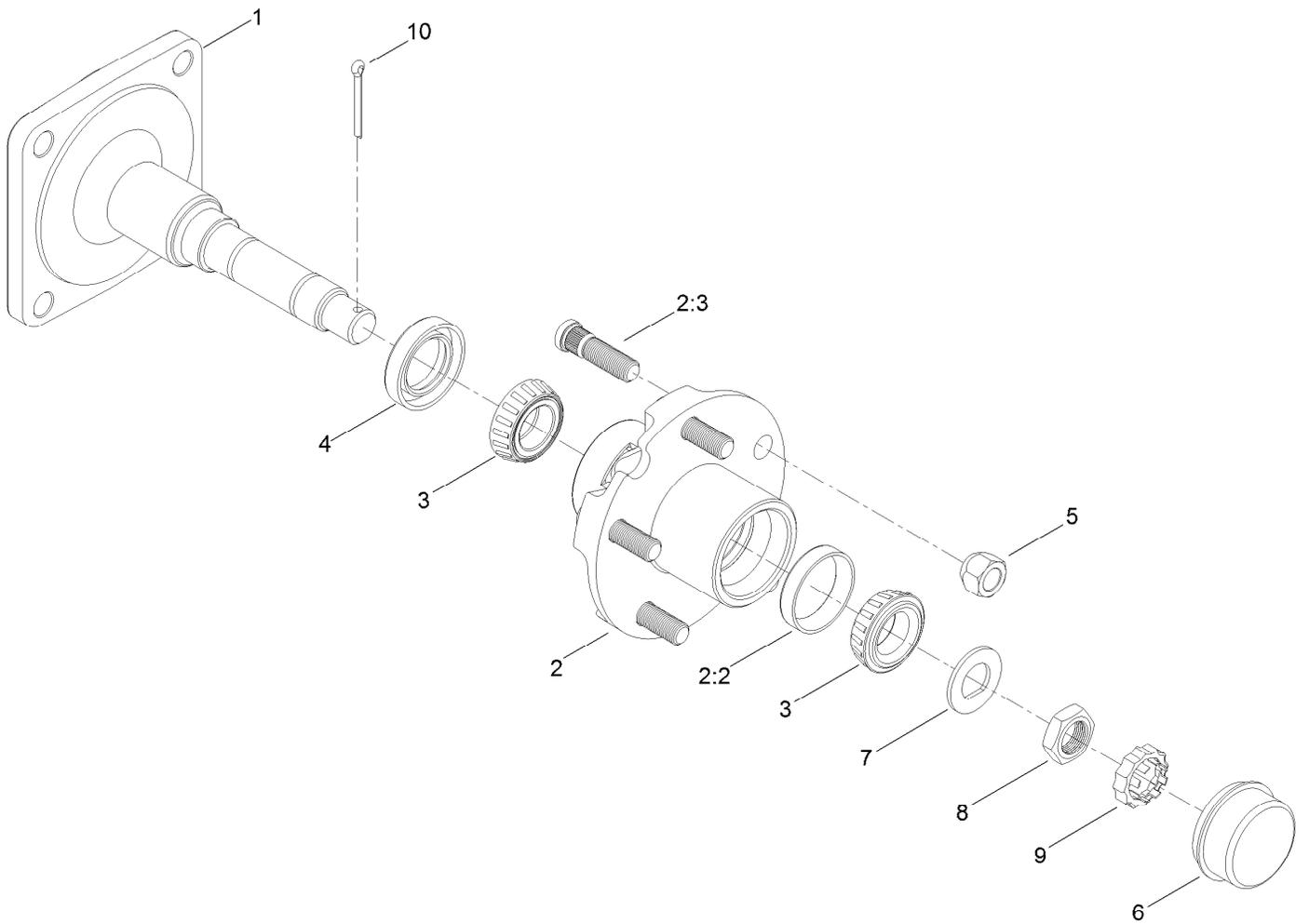

Hub and Spindle Assembly No. 117-8961

<i>Ref.</i>	<i>Part Number</i>	<i>Qty.</i>	<i>Description</i>
1	117-8958	1	Spindle
2	117-8963	1	Hub ASM
2:2	254-72	2	Bearing-Cup, Tapered
2:3	114-3918	5	Stud-Wheel
3	254-94	2	Bearing-Cone, Tapered
4	112-1690	1	Seal-Oil
5	242-50	5	Nut-Lug
6	241-119	1	Cap-Dust
7	117-8259	1	Washer-Spindle
8	117-8260	1	Nut
9	93-0307	1	Nut-Lock, Retainer
10	3272-18	1	Pin-Cotter

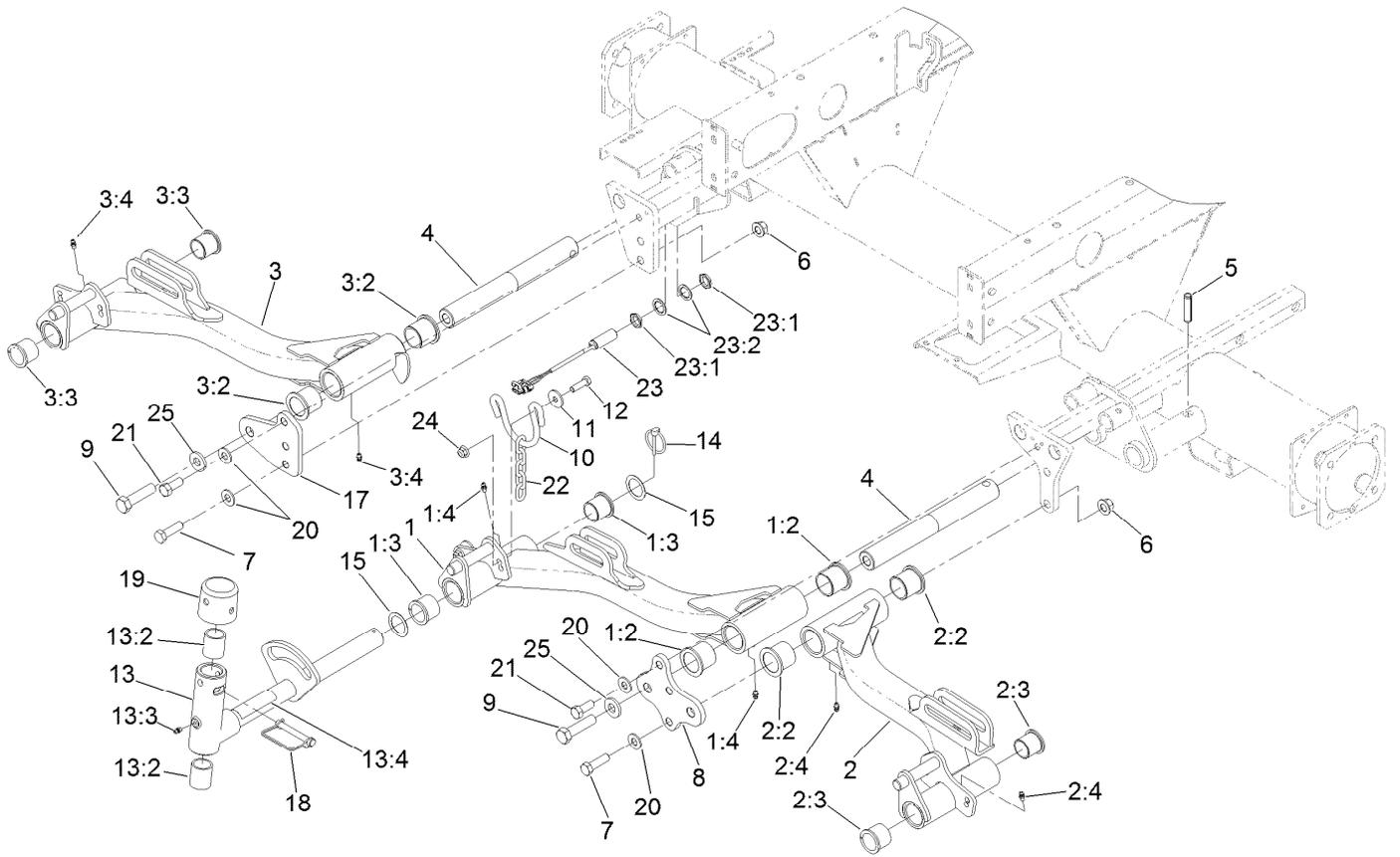

No. 1, 4 and 5 Lift Arm Assembly

Ref.	Part Number	Qty.	Description	Ref.	Part Number	Qty.	Description
1	136-8001	1	Lift Arm #1	11	63-8410	6	Washer
1:2	69-6470	2	Bushing-Caster	12	323-7	6	Screw-HH
1:3	104-0015	2	Bushing-Flange	13	107-2052	3	Pivot Yoke ASM
1:4	302-5	2	Fitting-Grease	13:2	121-3187	2	Bushing
2	136-8004	1	Lift Arm #4	13:3	302-5	1	Fitting-Grease
2:2	69-6470	2	Bushing-Caster	13:4	110-9642	1	Decal-Warning
2:3	104-0015	2	Bushing-Flange	14	92-1298	3	Pin-Lynch
2:4	302-5	2	Fitting-Grease	15	76-2980	6	Washer-Thrust
3	136-8005	1	Lift Arm #5	17	117-5153-01	1	Plate-Bridge 5
3:2	69-6470	2	Bushing-Caster	18	107-7400	3	Pin-Lynch
3:3	104-0015	2	Bushing-Flange	19	107-4027	3	Cap
3:4	302-5	2	Fitting-Grease	20	87-7270	6	Washer-Thrust
4	117-0208	3	Shaft-Pivot, Liftarm	21	325-5	2	Screw-HH
5	32121-122	3	Pin-Roll	22	84-2451	3	Chain-Straight, 5 Link
6	99-5107	4	Nut-Lock	23	115-5300	1	Proximity Switch ASM
7	325-7	4	Screw-HH	23:1	117-3207	2	Nut-Hex
8	117-5154-01	1	Plate-Bridge 1 And 4	23:2	117-3208	2	Washer-Lock, Internal Tooth
9	327-7	3	Screw-HH	24	104-8301	6	Nut-HF, NI
10	110-0922	3	Hoop-Chain	25	99-7667	3	Washer-Flat

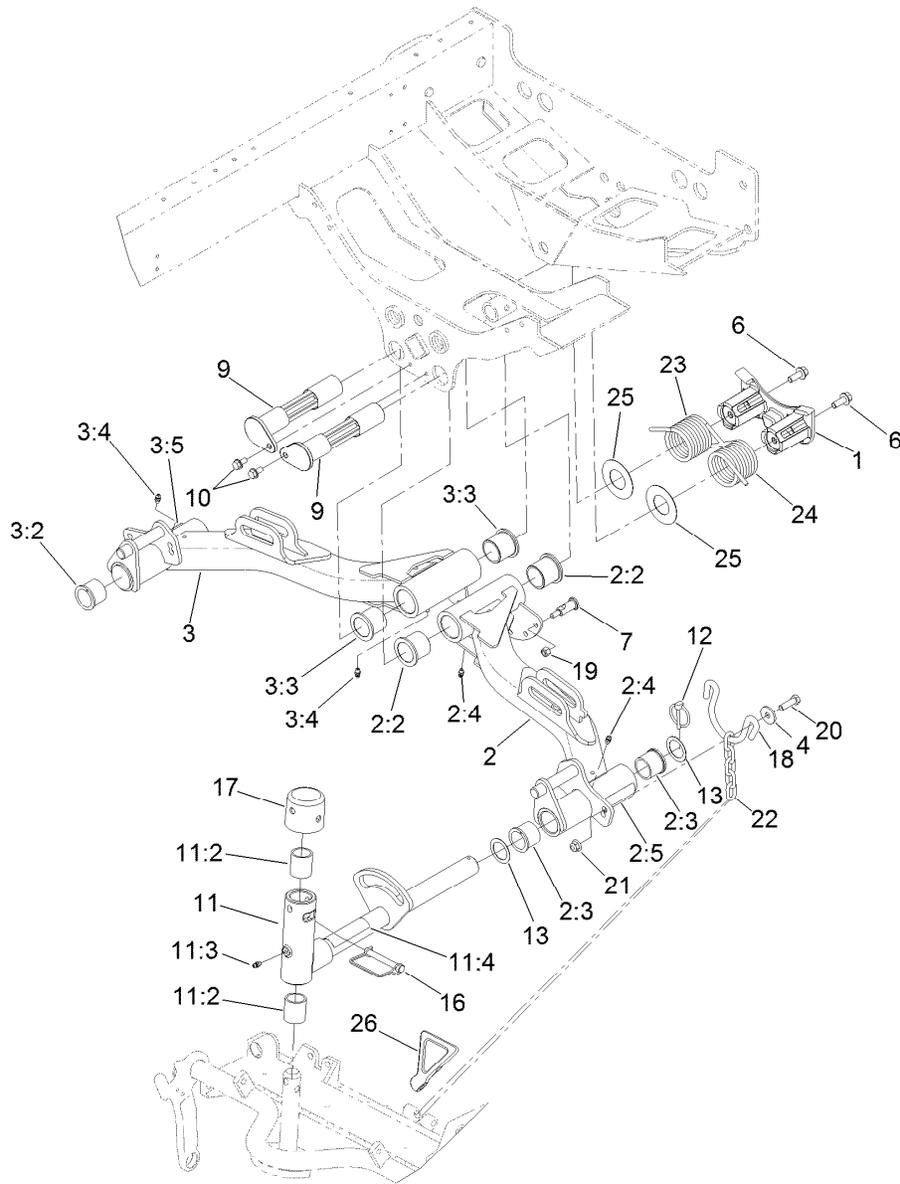

No. 2 and 3 Lift Arm Assembly

Ref.	Part Number	Qty.	Description
1	125-2018	1	Housing
2	136-8002	1	Lift Arm #2
2:2	69-6470	2	Bushing-Caster
2:3	104-0015	2	Bushing-Flange
2:4	302-5	2	Fitting-Grease
2:5	93-6696	1	Decal-Warning
3	136-8003	1	Lift Arm #3
3:2	69-6470	2	Bushing-Caster
3:3	104-0015	2	Bushing-Flange
3:4	302-5	2	Fitting-Grease
3:5	93-6696	1	Decal-Warning
4	63-8410	4	Washer
6	3234-11	2	Screw-HHF
7	120-6283	6	Stud-Shouldered
9	125-2037	2	Shaft
10	32144-14	2	Screw-HWHTF
11	107-2052	2	Pivot Yoke ASM

Ref.	Part Number	Qty.	Description
11:2	121-3187	2	Bushing
11:3	302-5	1	Fitting-Grease
11:4	110-9642	1	Decal-Warning
12	92-1298	2	Pin-Lynch
13	76-2980	4	Washer-Thrust
16	107-7400	2	Pin-Lynch
17	107-4027	2	Cap
18	110-0922	2	Hoop-Chain
19	3296-29	6	Nut-Lock, NI
20	323-7	4	Screw-HH
21	104-8301	4	Nut-HF, NI
22	84-2451	2	Chain-Straight, 5 Link
23	99-5608-03	1	Spring-Torsion, RH
24	99-5609-03	1	Spring-Torsion, LH
25	110-5345	2	Washer
26	119-8010-03	1	Kickstand

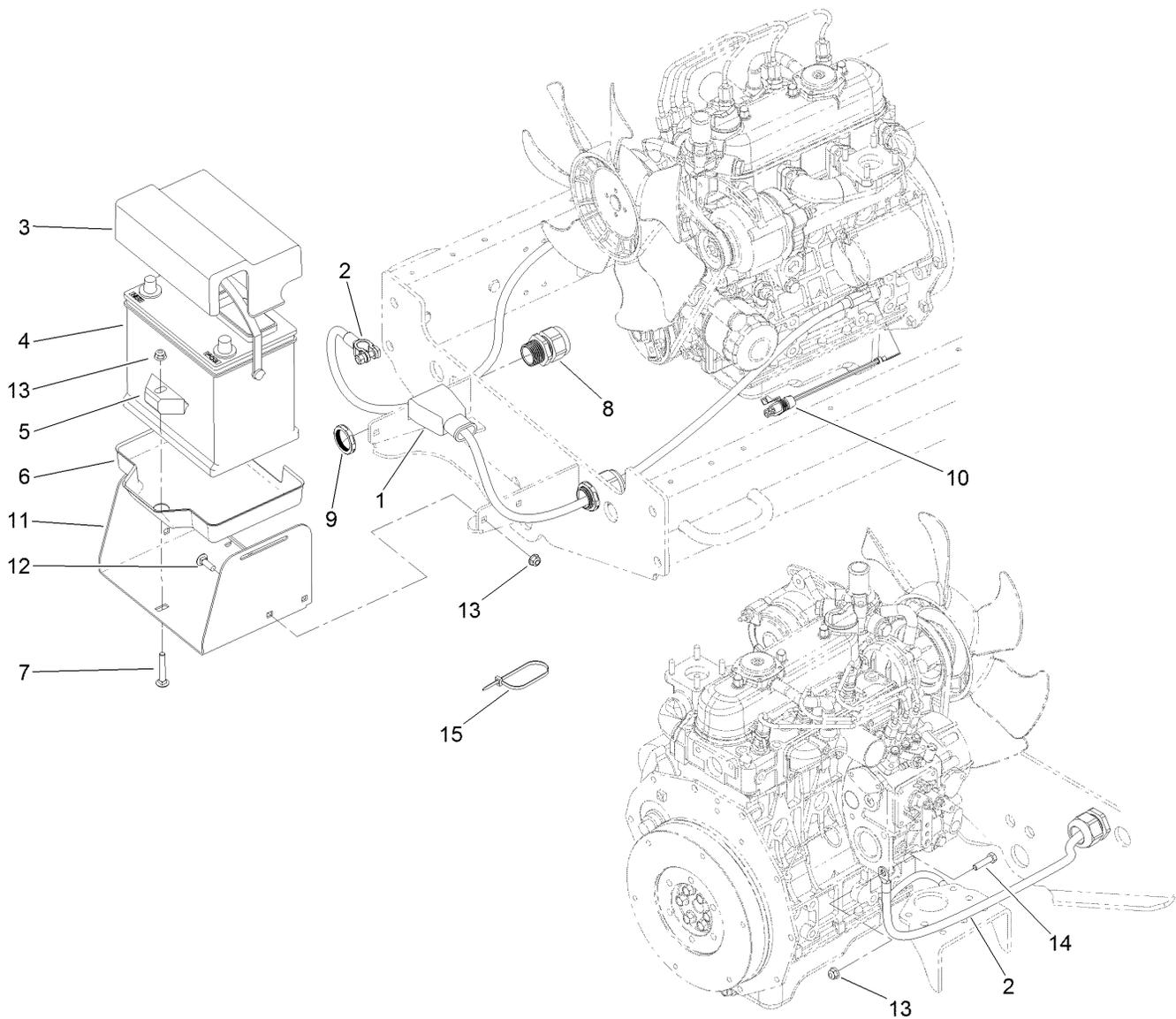

Battery Mounting Assembly

Ref.	Part Number	Qty.	Description
1	120-6398	1	Cable-Battery, Positive
2	120-6399	1	Cable-Battery, Negative
3	121-5615	1	Cover-Battery
4	104-9979	1	Battery
5	66-2490	1	Retainer-Battery
6	127-2781	1	Mat-Battery
7	3230-6	1	Bolt-CARR
8	121-8854	2	Grip-Cord
9	121-8855	2	Locknut-Grip, Cord
10	99-3441	1	Harness-Wire, Fusible Link
11	125-1583-03	1	Tray-Battery
12	3230-2	4	Bolt-CARR
13	104-8300	6	Nut-HF, NI
14	322-6	1	Screw-HH
15	3290-378	5	Tie-Cable

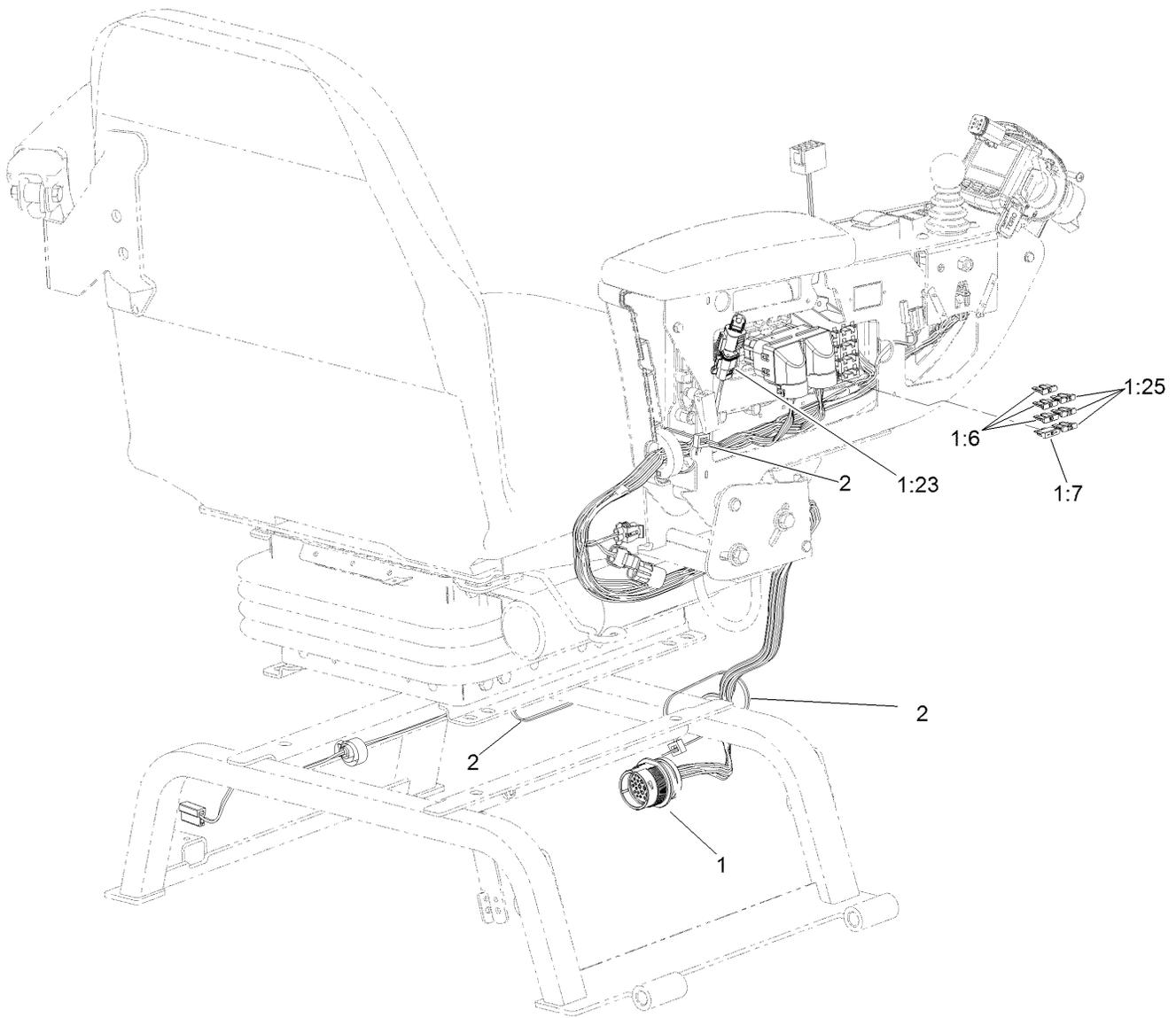

Control Console Electrical Assembly

<i>Ref.</i>	<i>Part Number</i>	<i>Qty.</i>	<i>Description</i>
1	121-6598	1	Harness-Wire, Seat
1:6	218-578	3	Fuse-Blade, 10 Amp
1:7	109355	1	Fuse-Blade, 15 Amp
1:23	32180-043	1	Resistor-120 Ohm
1:25	114241	3	Fuse-Blade, 7.5 Amp
2	3290-378	3	Tie-Cable

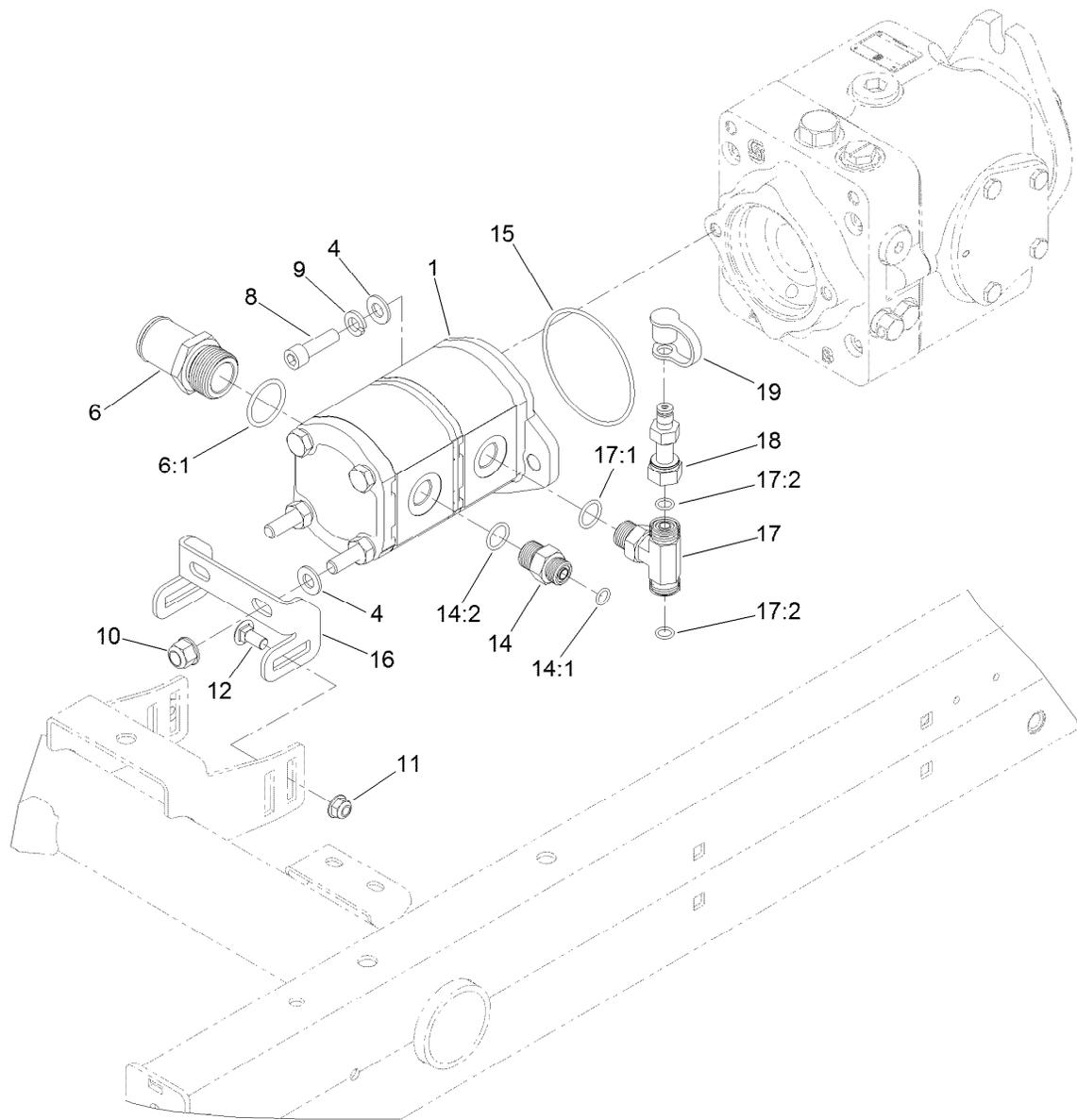

Gear Pump Assembly

<i>Ref.</i>	<i>Part Number</i>	<i>Qty.</i>	<i>Description</i>	<i>Ref.</i>	<i>Part Number</i>	<i>Qty.</i>	<i>Description</i>
1	125-1530	1	Tandem Gear Pump ASM	14:1	237-22	1	O-Ring
4	3256-24	4	Washer-Flat	14:2	237-79	1	O-Ring
6	125-1528	1	Fitting-STR	15	237-161	1	O-Ring
6:1	237-146	1	O-Ring	16	108-1801-01	1	Bracket-Support, Pump
8	3274-1	2	Screw-HSH	17	92-4799	1	Fitting-Tee, HYD
9	3253-5	2	Washer-Lock	17:1	237-79	1	O-Ring
10	103-9511	2	Nut-Lock, NI	17:2	237-22	2	O-Ring
11	104-8300	2	Nut-HF, NI	18	86-5480	1	Nipple-Test
12	3230-1	2	Bolt-CARR	19	354-79	1	Cap-Dust
14	340-3	1	Fitting-Straight				

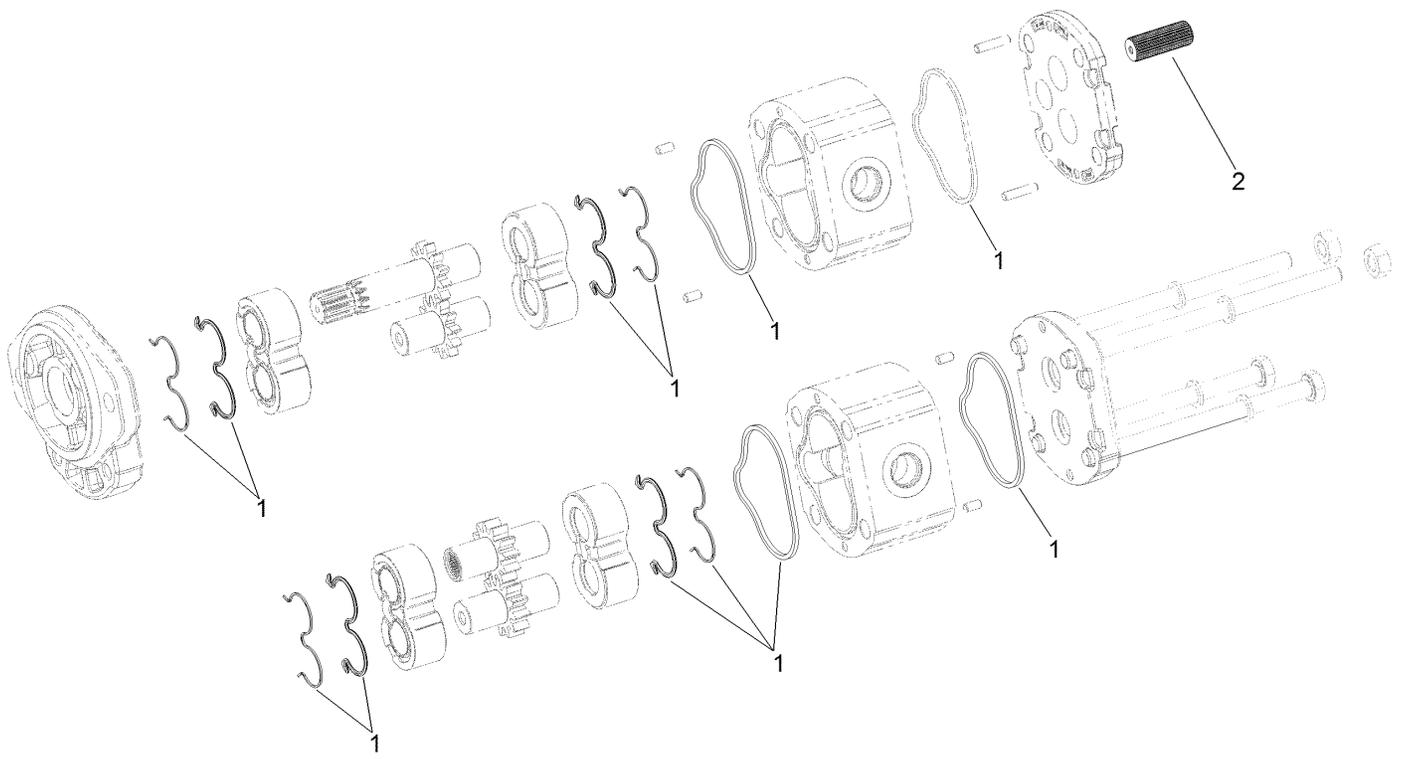

Tandem Gear Pump Assembly No. 125-1530

<i>Ref.</i>	<i>Part Number</i>	<i>Qty.</i>	<i>Description</i>
1	120-5155	1	Seal Kit
2	120-6284	1	Hub-Connecting

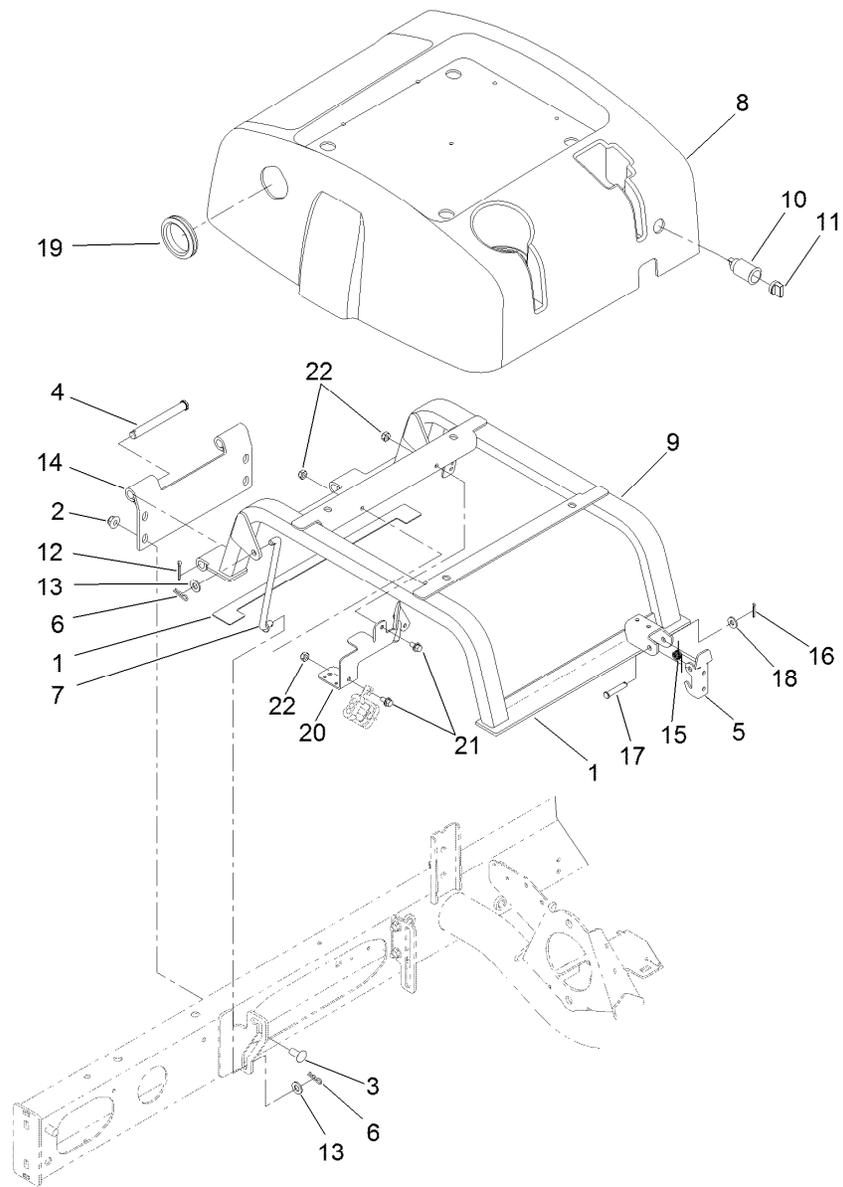

Seat Base Assembly

<i>Ref.</i>	<i>Part Number</i>	<i>Qty.</i>	<i>Description</i>	<i>Ref.</i>	<i>Part Number</i>	<i>Qty.</i>	<i>Description</i>
1	110-5255	2	Bumper-Base, Seat	12	3272-11	2	Pin-Cotter
2	104-8301	4	Nut-HF, NI	13	3256-24	4	Washer-Flat
3	3231-27	4	Screw-CARR	14	125-2121-03	1	Hinge-Seatbase
4	283-83	2	Pin-Clevis	15	104-4821	1	Spring-Torsion
5	110-8971	1	Latch	16	3272-6	1	Pin-Cotter
6	3290-307	4	Pin-Cotter	17	94-3829	1	Pin-Clevis
7	98-0917	2	Rod-Prop	18	3256-2	1	Washer-Flat
8	108-1757	1	Cover-Seatbase	19	240-12	1	Grommet-Rubber
9	125-2122-03	1	Seat Base ASM	20	127-2377-03	1	Bracket-Harness
10	99-7411	1	Point-Power	21	3234-13	2	Screw-HHF
11	99-7416	1	Cap	22	3296-16	2	Nut-Lock, NI

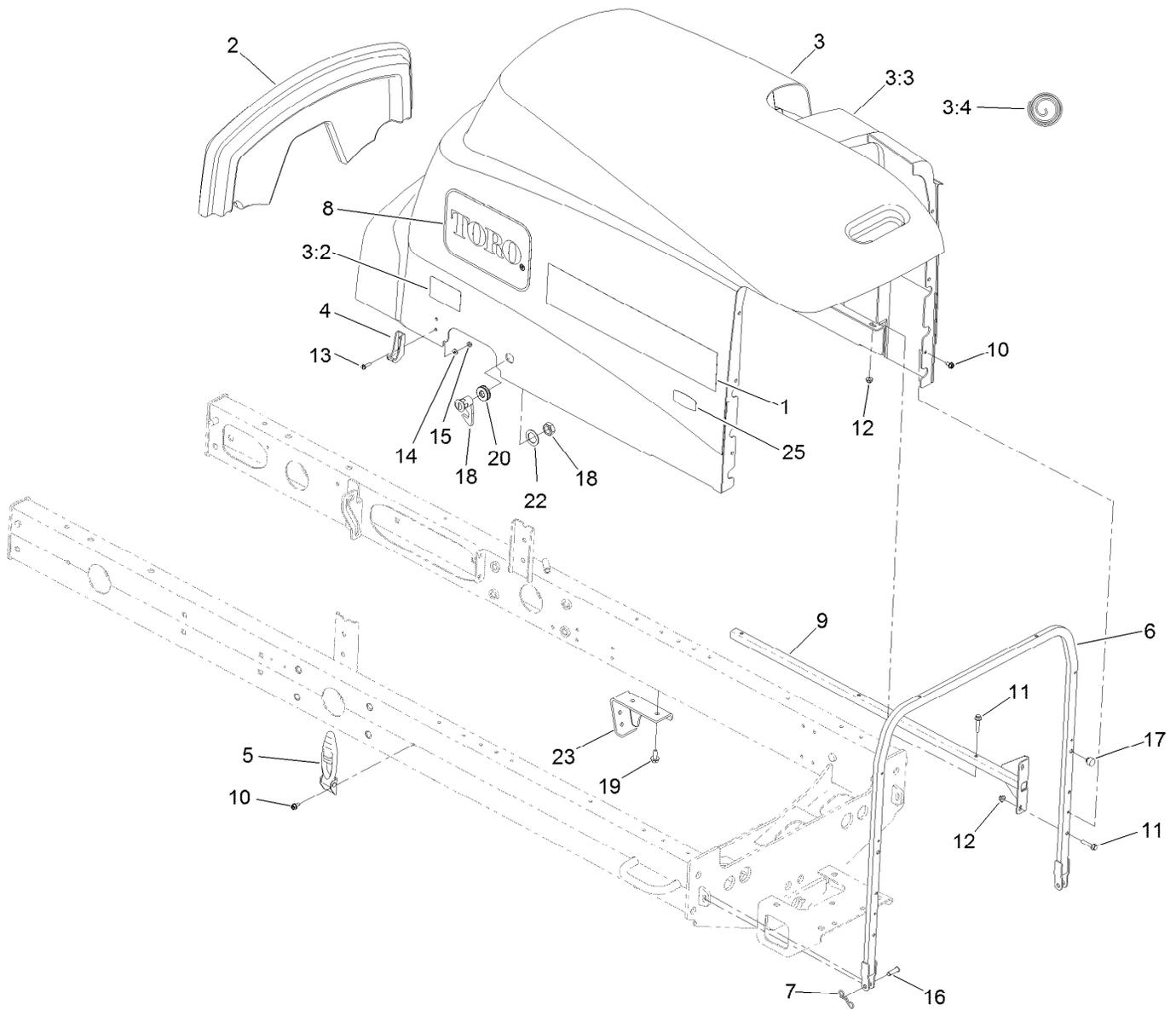

Hood Assembly

<i>Ref.</i>	<i>Part Number</i>	<i>Qty.</i>	<i>Description</i>	<i>Ref.</i>	<i>Part Number</i>	<i>Qty.</i>	<i>Description</i>
1	127-2304	2	Decal	11	3234-21	10	Screw-HHF
2	108-7587	1	Saddle-Hood	12	104-7201	10	Nut-HF, NI
3	110-8994	1	Hood ASM	13	32105-13	4	Screw-HWH
3:2	106-6754	1	Decal-Danger	14	3256-14	4	Washer-Flat
3:3	110-5252	1	Foam-Sealed	15	3296-12	4	Nut-Lock, NI
3:4	110-9002	1	Foil Tape Kit	16	283-61	2	Pin-Yoke
4	103-2897	2	Latch-Catch	17	107-8042	2	Bumper-Rubber
5	103-2898	2	Latch-Rubber	18	98-5398	1	Latch
6	125-8819-03	1	Tube-Frame, Hood	19	32104-32	4	Screw-HWH
7	105-7512	2	Pin-Tie, Bow	20	104-1453	1	Grommet
8	66-6140	2	Decal	22	99-4958	1	Spacer
9	108-1790-03	2	Tube	23	110-0979-03	2	Bracket-Deflector
10	32104-17	8	Screw-HWH	25	119-7580	2	Decal-Smart, Energy

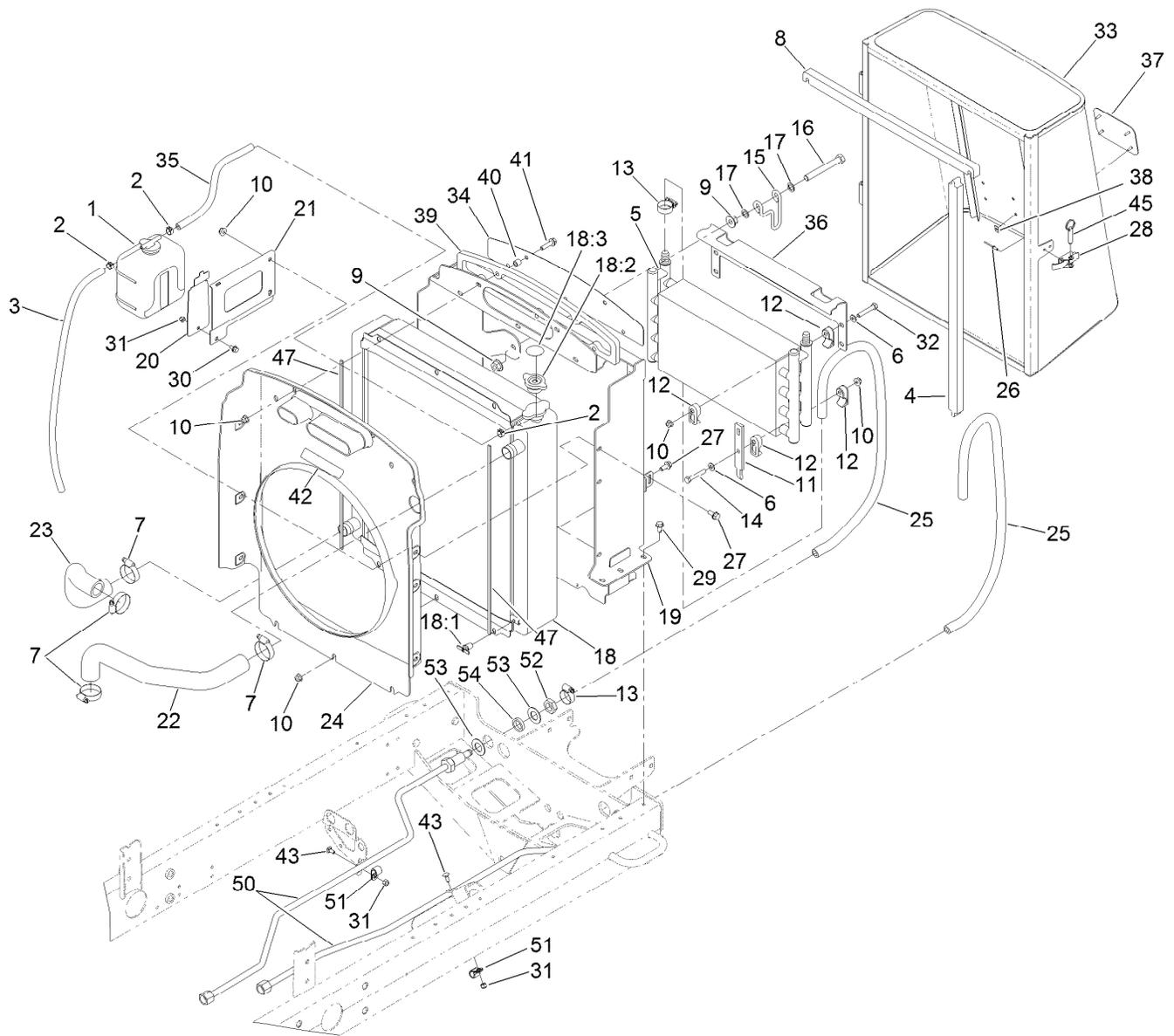

Radiator Assembly

Ref.	Part Number	Qty.	Description	Ref.	Part Number	Qty.	Description
1	108-0638	1	Bottle-Overflow	19	127-2665-03	1	Frame-Support, Radiator
2	92-2379	3	Clamp-Hose	20	108-1665-03	1	Bracket-Reservoir
3	110-3257	1	Hose-Fuel	21	108-1666-03	1	Bracket-Reservoir
4	110-0967	2	Seal-Foam	22	108-1696	1	Hose-Formed
5	127-2480	1	Cooler-Oil	23	108-1697	1	Hose-Formed
6	3256-23	8	Washer-Plain	24	127-2474	1	Shroud-Fan
7	2412-34	4	Clamp-Hose	25	127-2346	2	Hose
8	110-0968	2	Seal-Foam	26	3269-15	2	Rivet-Pop
9	32128-49	4	Nut-HHF	27	3234-5	9	Screw-HHF
10	104-8300	22	Nut-HF, NI	28	115-1554	1	Latch-Draw
11	104-5460-03	2	Plate-Mount, Oil Cooler	29	32104-32	6	Screw-HWH
12	105-3943	16	Clamp-Cooler, Oil	30	3234-13	1	Screw-HHF
13	2412-119	4	Clamp-Hose, Worm Drive	31	3296-42	3	Nut-Lock, NI
14	322-10	4	Screw-HH	32	322-21	4	Screw-HH
15	104-5429	2	Clamp-Form, Wire	33	110-0952-03	1	Screen ASM
16	325-17	2	Screw-HH	34	108-1843-03	1	Screen-Intake, Air
17	41-8440	4	Washer	35	110-4104	1	Hose-Fuel
18	119-6956	1	Radiator ASM	36	107-2043-03	1	Bracket-Oil Cooler, Top
18:1	304-46	1	Draincock	37	93-6028	1	Plate-Logo
18:2	93-5957	1	Cap-Radiator	38	94-2638	4	Nut-Flat
18:3	106-6755	1	Decal-Cap, Radiator	39	110-5324	1	Seal-Foam

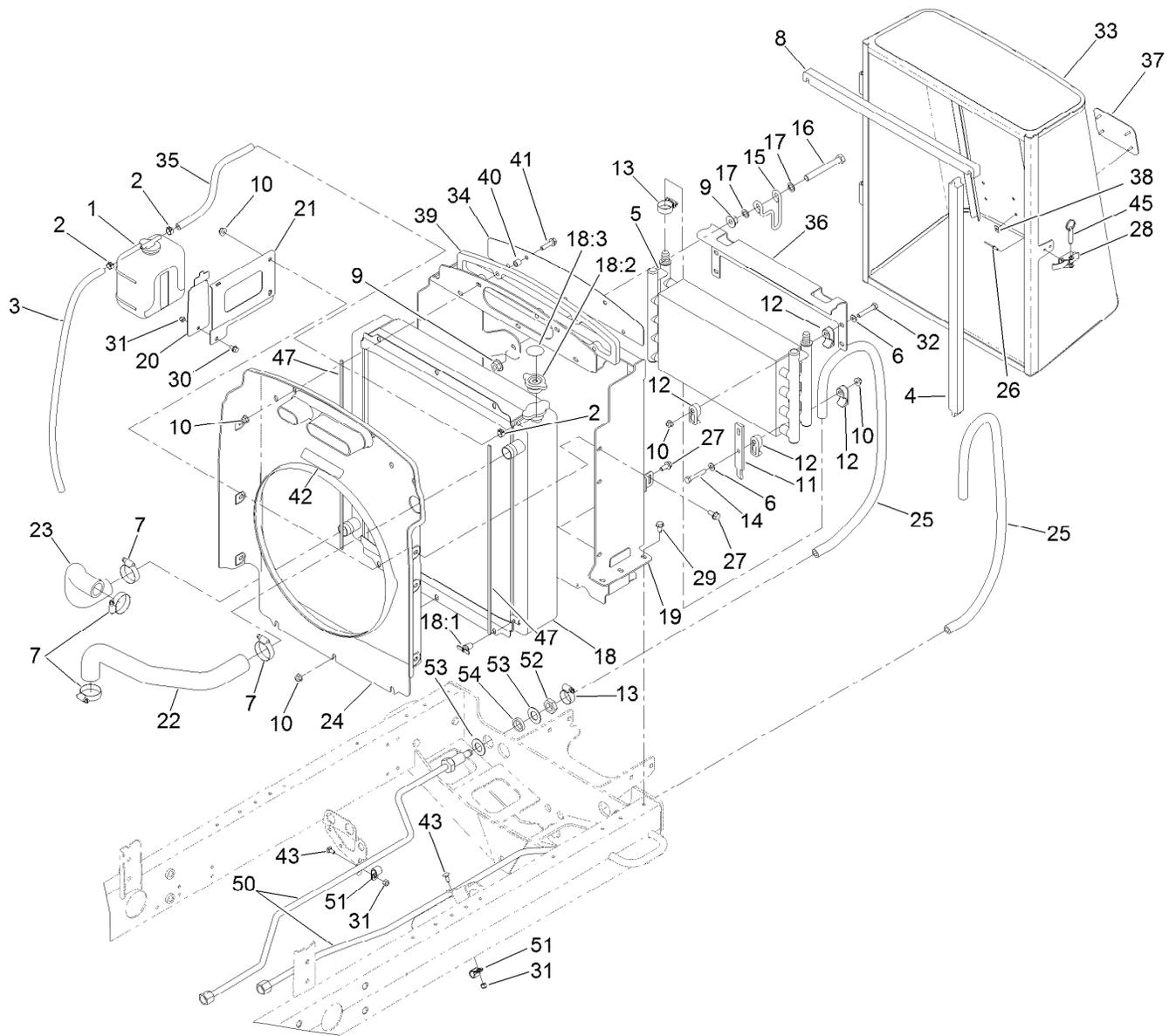

Radiator Assembly (continued)

<i>Ref.</i>	<i>Part Number</i>	<i>Qty.</i>	<i>Description</i>	<i>Ref.</i>	<i>Part Number</i>	<i>Qty.</i>	<i>Description</i>
40	1-603903	5	Spacer	47	110-0971	2	Seal-Foam
41	3234-36	5	Screw-HHF	50	127-2475	2	Tube ASM
42	93-7272	1	Decal-Warning	51	2412-73	2	Clamp-R
43	3229-11	2	Screw-CARR	52	340-127	2	Nut-Bulkhead
44	106-6755	1	Decal-Cap, Radiator	53	69-8930	4	Washer
45	115-1556	1	Pin-Ball, Detent	54	127-2344	2	Spacer

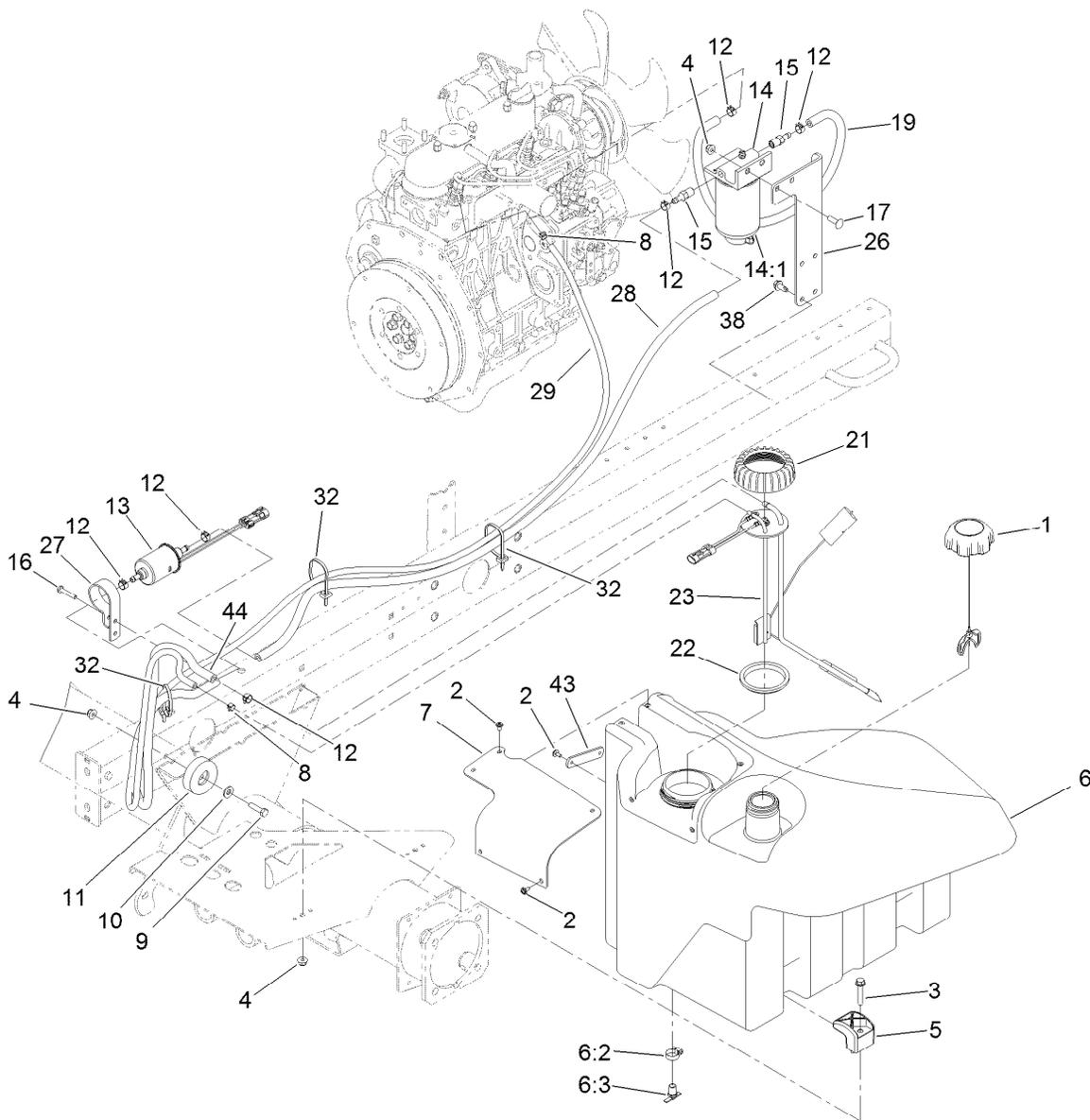

Fuel System Assembly

Ref.	Part Number	Qty.	Description	Ref.	Part Number	Qty.	Description
1	117-5894	1	Fuel Cap ASM	14:1	110-9049	1	Filter-Spin On, Fuel/Water
2	109-2661	7	Screw-PPH	15	353-783	2	Fitting-STR
3	94-5780	2	Screw-HWH	16	32104-96	1	Screw-HH
4	104-8300	5	Nut-HF, NI	17	3230-22	2	Screw-CARR
5	107-4543	2	Clamp	19	109-0309	1	Hose-Fuel
6	125-2907	1	Fuel Tank ASM	21	115-2162	1	Cap-Pump, Fuel
6:2	2412-36	1	Clamp-Hose	22	115-2163	1	Gasket-Pump, Fuel
6:3	304-46	1	Draincock	23	121-5642	1	Sender-Fuel
7	125-2903	1	Cover-Pump/Sender	26	110-8968-01	1	Mount-Separator, Water
8	2412-80	2	Clamp-Hose	27	110-8817	1	Bracket-Pump, Fuel
9	322-6	1	Screw-HH	28	110-3259	1	Hose-Fuel
10	3256-3	1	Washer-Flat	29	125-8808	1	Hose-Fuel
11	108-1605	1	Bumper-Recess	32	3290-378	3	Tie-Cable
12	92-2379	6	Clamp-Hose	38	32104-32	4	Screw-HWH
13	110-8806	1	Pump-Fuel	43	125-2945	1	Strap-Cable
14	110-9044	1	Separator-Filter	44	110-3258	1	Hose-Fuel

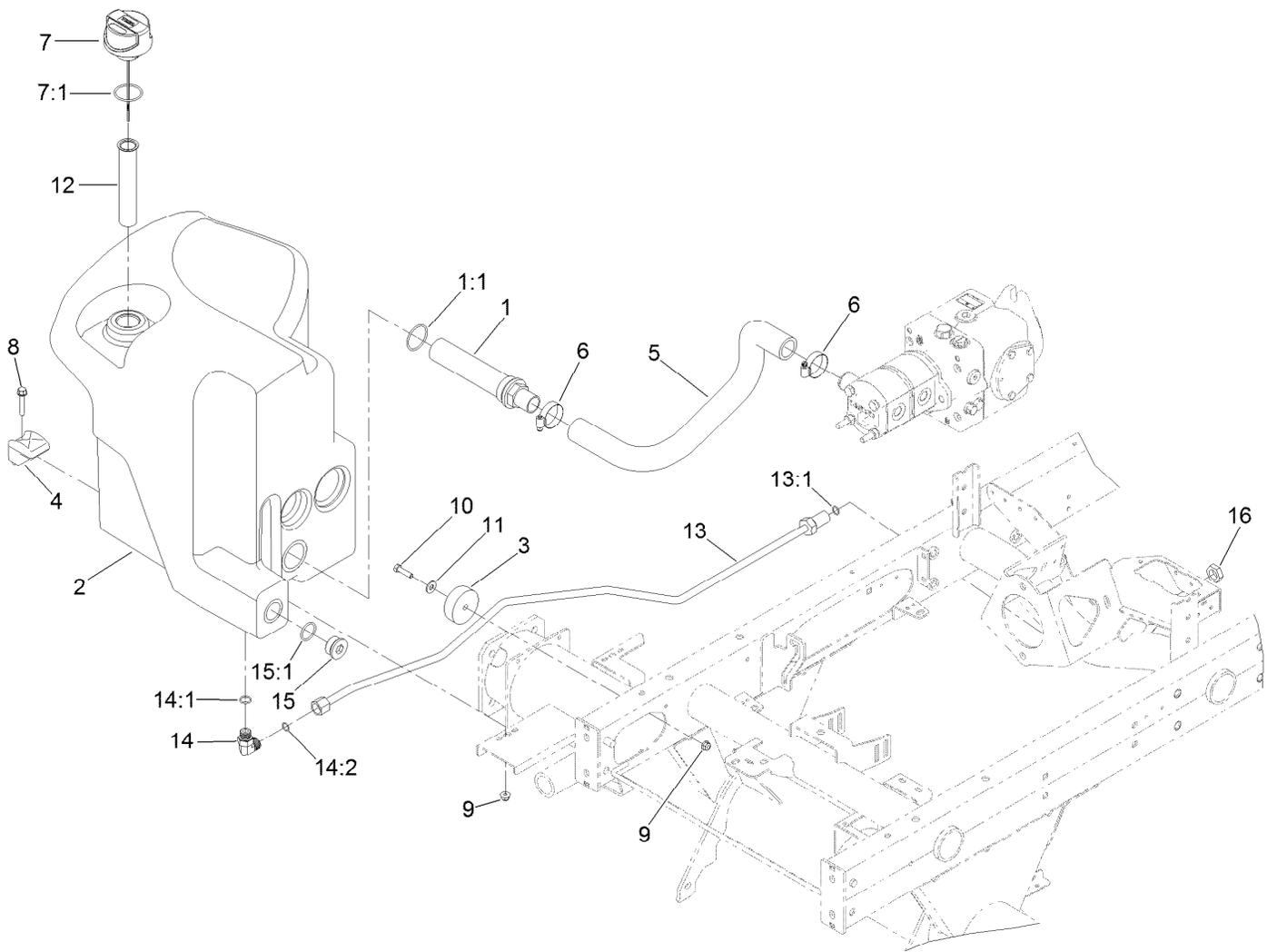

Hydraulic Tank Assembly

<i>Ref.</i>	<i>Part Number</i>	<i>Qty.</i>	<i>Description</i>	<i>Ref.</i>	<i>Part Number</i>	<i>Qty.</i>	<i>Description</i>
1	105-0131	1	Strainer-Tank, Oil	10	322-6	1	Screw-HH
1:1	340-136	1	O-Ring	11	3256-3	1	Washer-Flat
2	121-5587	1	Tank-Hydraulic	12	61-2790	1	Filter-Screen
3	108-1605	1	Bumper-Recess	13	127-2476	1	Tube-ASM.
4	107-4543	2	Clamp	13:1	237-30	1	O-Ring
5	125-1527	1	Hose-Suction	14	340-98	1	Fitting-Elbow, 90 DEG
6	2412-3	2	Clamp-Hose	14:1	237-79	1	O-Ring
7	117-0193	1	Cap-Hydraulic, Vented	14:2	237-30	1	O-Ring
7:1	237-101	1	Breather	15	105-3921	1	Fitting-Plug
8	94-5780	2	Screw-HWH	15:1	237-146	1	O-Ring
9	104-8300	3	Nut-HF, NI	16	340-127	1	Nut-Bulkhead

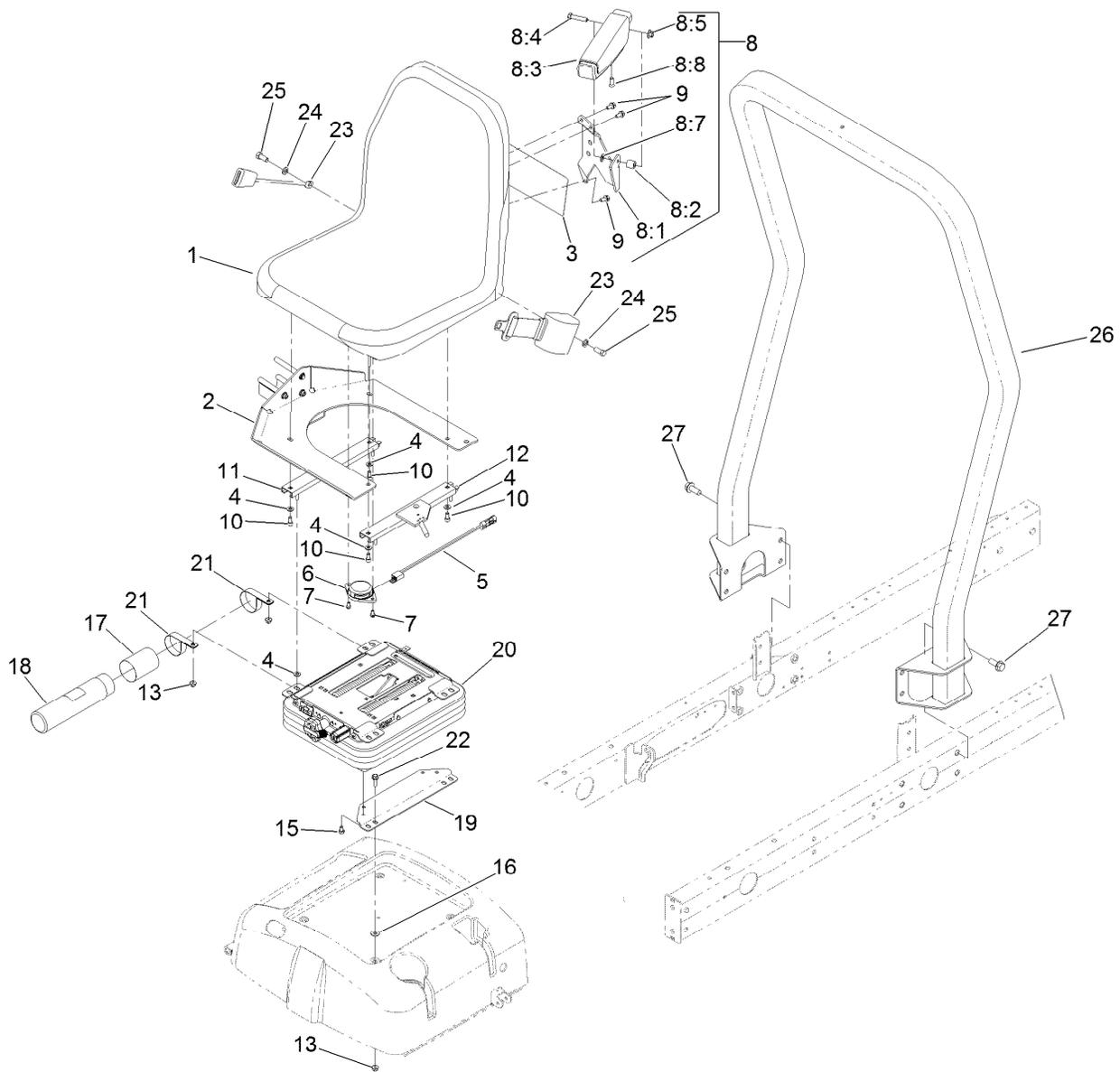

Seat Mounting Assembly

Ref.	Part Number	Qty.	Description	Ref.	Part Number	Qty.	Description
1	104-4620	1	Seat	11	92-8990	1	Adjuster-Seat, Non-Locking
2	125-2900-03	1	Mount-Seat	12	92-8991	1	Adjuster (W/Latch)
3	125-8753	1	Decal-Service	13	104-8300	8	Nut-HF, NI
3	125-8798	1	Decal-Service, Japanese	15	48-7680	4	Screw-HH
4	3256-23	8	Washer-Plain	16	71-9310	4	Spacer
5	108-8657	1	Harness-Wire, Seat	17	104-7048	1	Cap-Housing
6	92-6282	1	Switch-Seat	18	104-7050	1	Tube-Manual
7	9266714	2	Screw-HWH	19	108-6590-03	2	Bracket-Seat, Lower
8	92-7307	1	LH Armrest ASM	20	110-8851	1	Mechanical Suspension ASM
8:1	69-0760	1	Bracket-Arm, LH	21	2412-133	2	Clamp-R
8:2	92-7301	1	Spacer	22	3234-17	4	Screw-HHF
8:3	69-1180	1	Armrest	23	100-4928	1	Belt-Seat
8:4	323-9	1	Screw-HH	24	3253-6	2	Washer-Lock
8:5	32128-19	1	Nut-HF Lock, Large Flg	25	3212-4	2	Screw-HH
8:7	3256-24	1	Washer-Flat	26	136-7954	1	ROPS ASM
8:8	92-7318	1	Screw	27	3234-38	8	Screw-HHF
9	3234-14	3	Screw-HHF				
10	3274-12	4	Screw-HSH				

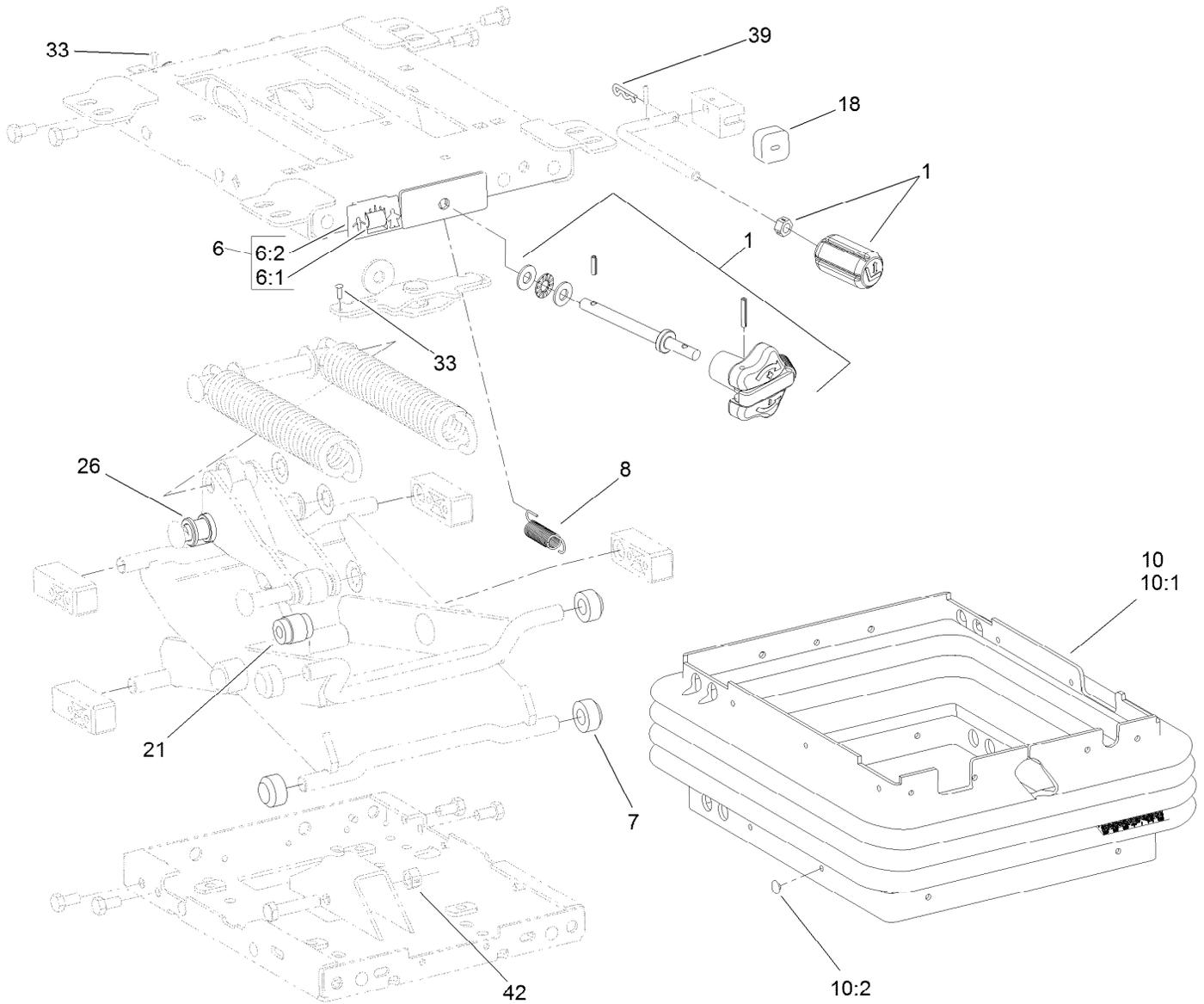

Mechanical Seat Suspension Assembly No. 110-8851

Ref.	Part Number	Qty.	Description
1	119-8040	1	Knobs Service Kit
6	108-4584	1	Weight Indicator Service Kit
6:1		1	Tape-Weight Adjust ●
6:2		1	Guide-Weight Adjust ●
7	108-9632	4	Roller
8	108-9633	1	Spring-Extension
10	112-0164	1	Boot Kit
10:1		1	Boot-Suspension ●
10:2	108-9641	21	Clip-Plug
18	108-9634	1	Bumper
21	108-9614	1	Damper
26	108-9622	2	Tube
33	3290-54	2	Rivet-Blind
39	3272-9	1	Pin-Cotter
42	32152-2	1	Nut-Lock, Cone

● Not serviced separately

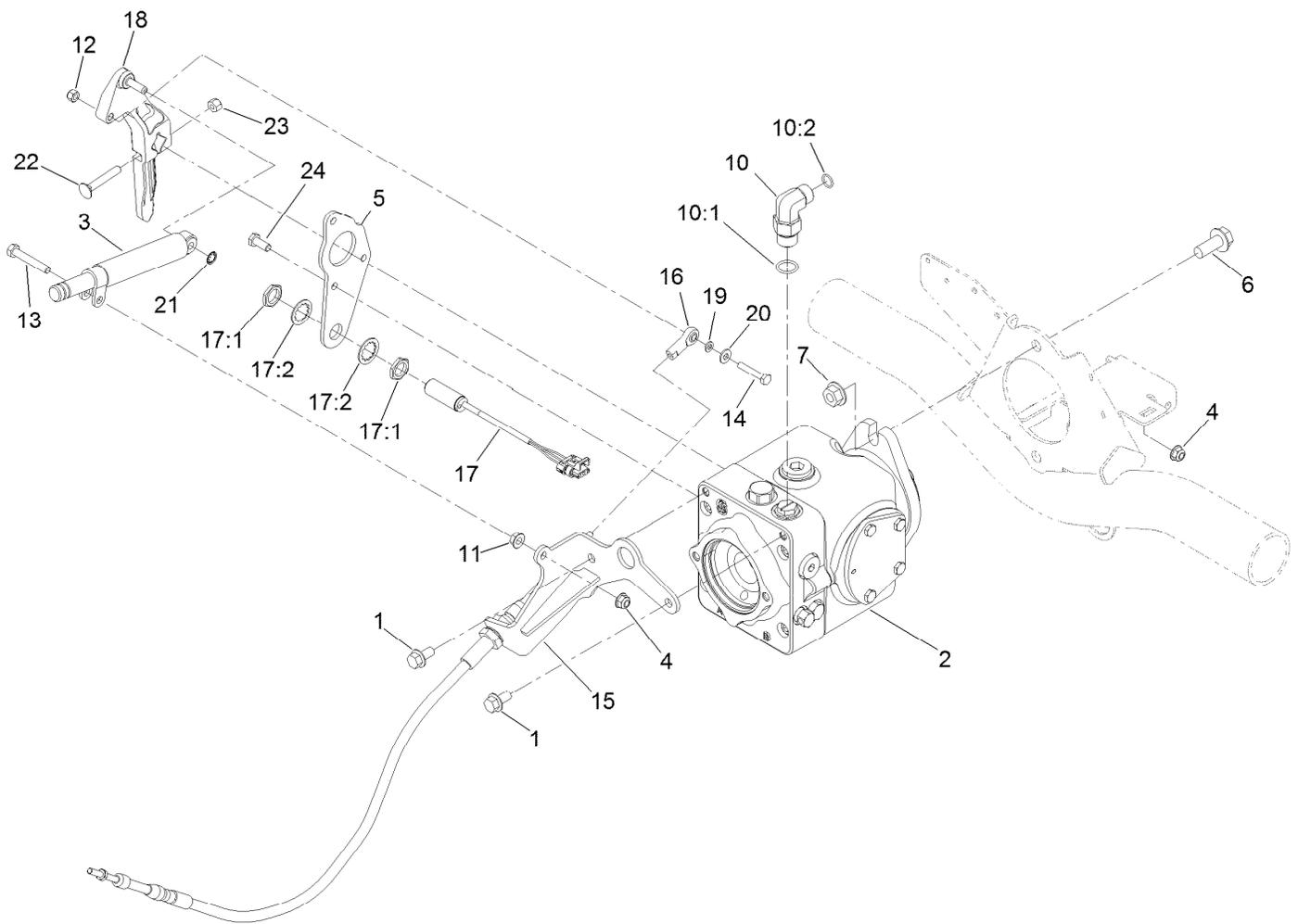

Traction Pump Mounting Assembly

<i>Ref.</i>	<i>Part Number</i>	<i>Qty.</i>	<i>Description</i>	<i>Ref.</i>	<i>Part Number</i>	<i>Qty.</i>	<i>Description</i>
1	3234-1	2	Screw-HHF	14	321-9	1	Screw-HH
2	119-6972	1	Variable Hydraulic Pump ASM	15	127-2356-03	1	Bracket-Cable
3	76-8870	1	Damper-Lever	16	2411-41	1	Rod End-Ball Joint
4	104-8300	1	Nut-HF, NI	17	115-5300	1	Proximity Switch ASM
5	125-8822-03	1	Plate-Pump	17:1	117-3207	2	Nut-Hex
6	3234-38	2	Screw-HHF	17:2	117-3208	2	Washer-Lock, Internal Tooth
7	32128-49	2	Nut-HHF	18	117-0265	1	Lever-Pump
10	340-105	1	Fitting-Elbow, 90 DEG	19	33093-00	1	Washer-Flat
10:1	237-80	1	O-Ring	20	3256-22	1	Washer-Flat
10:2	237-30	1	O-Ring	21	32151-72	1	Ring-Retaining
11	32128-20	1	Nut-HF	22	3230-6	1	Bolt-CARR
12	3296-42	1	Nut-Lock, NI	23	3296-29	1	Nut-Lock, NI
13	322-10	1	Screw-HH	24	33114-020	3	Screw-HH

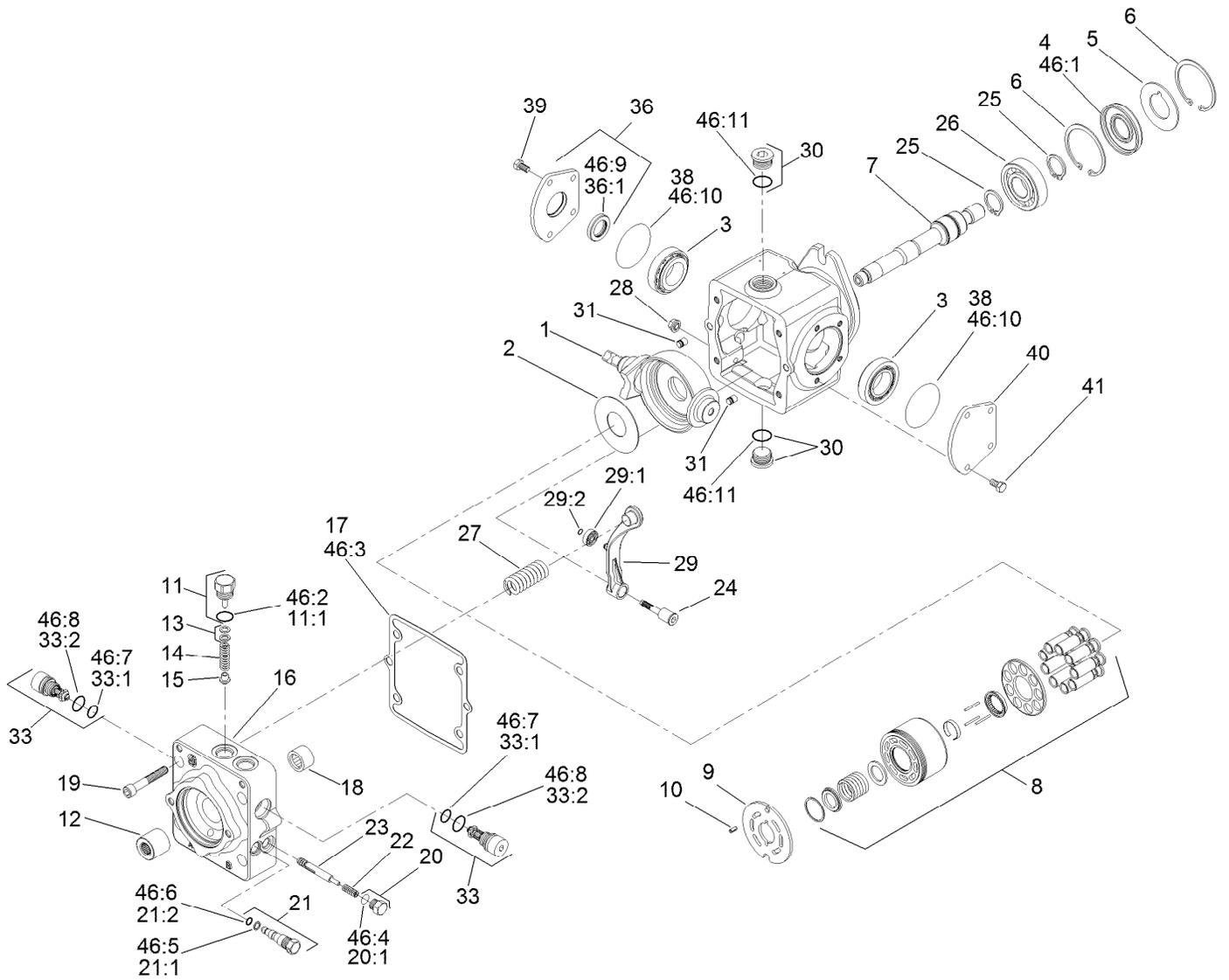

Hydraulic Pump Assembly No. 119-6972

Ref.	Part Number	Qty.	Description	Ref.	Part Number	Qty.	Description
1	115-8092	1	Swashplate	18	75-0500	1	Bearing-Needle
2	75-0400	1	Plate-Thrust	19	110-6489	4	Screw
3	110-6483	2	Bearing Kit	20	94-9415	2	Plug ASM
4	110-6471	1	Seal-Lip	20:1		1	O-Ring ■
5	95-4400	1	Washer-Backup	21	107-4364	1	Bypass Valve ASM
6	69-3200	2	Ring-Retaining	21:1	25-2630	1	Ring-Back Up
7	110-6484	1	Shaft-Auxiliary	21:2	110-6498	1	O-Ring
8	110-6472	1	Cylinder Block Kit ASM	22	110-6491	2	Spring
9	110-6473	1	Plate-Valve (Clockwise)	23	110-6492	1	Spool-Loop, Flush
10	110-6485	1	Pin-Slotted	24	110-6493	1	Pivot-Return, Neutral
11	110-6486	1	Plug-Relief, Charge	25	69-3170	2	Ring-Retaining
11:1	28-3570	1	O-Ring	26	75-0460	1	Bearing-Ball
12	110-6480	1	Coupling	27	115-8085	1	Spring-Neutral Return
13	92-1353	1	Shim Kit	28	110-6496	1	Nut-Seal
14	110-6474	1	Spring	29	110-6497	1	Neutral Return Arm ASM
15	110-6475	1	Poppet	29:1	110-6494	1	Bearing-Cam
16	115-8087	1	Cap-End	29:2	110-3056	1	Ring-Retaining
17	110-6476	1	Gasket-Cap, End	30	69-3130	2	Plug

● Not illustrated

■ Not serviced separately

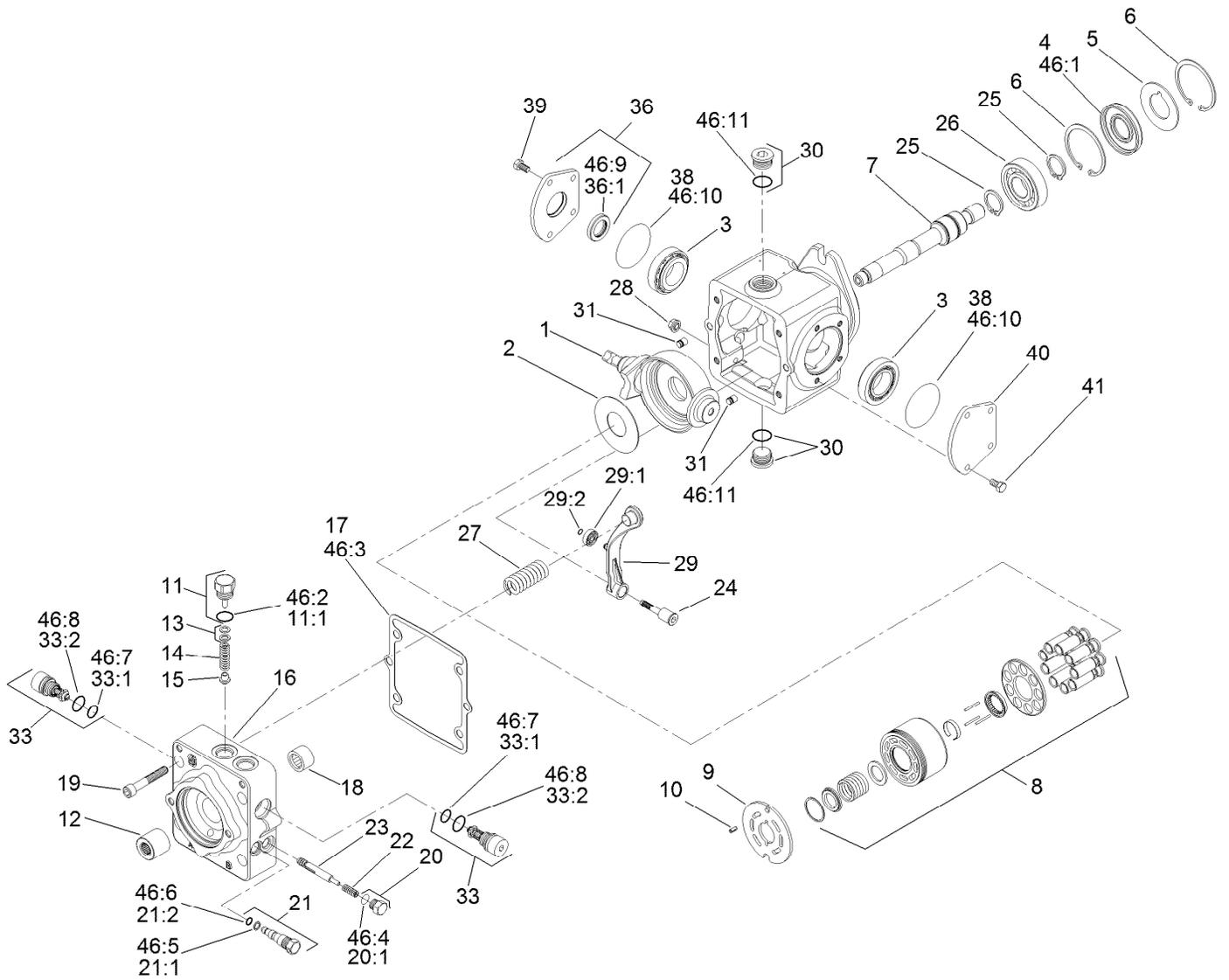

Hydraulic Pump Assembly No. 119-6972 (continued)

Ref.	Part Number	Qty.	Description	Ref.	Part Number	Qty.	Description
31	112-0158	2	Pin	46:1	110-6471	1	Seal-Lip
33	110-6477	2	Valve-Relief	46:2	28-3570	1	O-Ring
33:1	75-0240	1	O-Ring	46:3	110-6476	1	Gasket-Cap, End
33:2	84-0560	1	O-Ring	46:4	131-8631	2	O-Ring
36	110-6499	1	Trunnion Cover ASM	46:5	25-2630	1	Ring-Back Up
36:1	110-6478	1	Seal-Lip	46:6	110-6498	1	O-Ring
38	84-0430	2	O-Ring	46:7	75-0240	2	O-Ring
39	112-0150	4	Screw	46:8	84-0560	2	O-Ring
40	84-0440	1	Cover-Trunnion	46:9	110-6478	1	Seal-Lip
41	112-0151	4	Screw	46:10	84-0430	2	O-Ring
46	110-6481	1	Seal Kit ●	46:11	131-8614	2	O-Ring

● Not illustrated

■ Not serviced separately

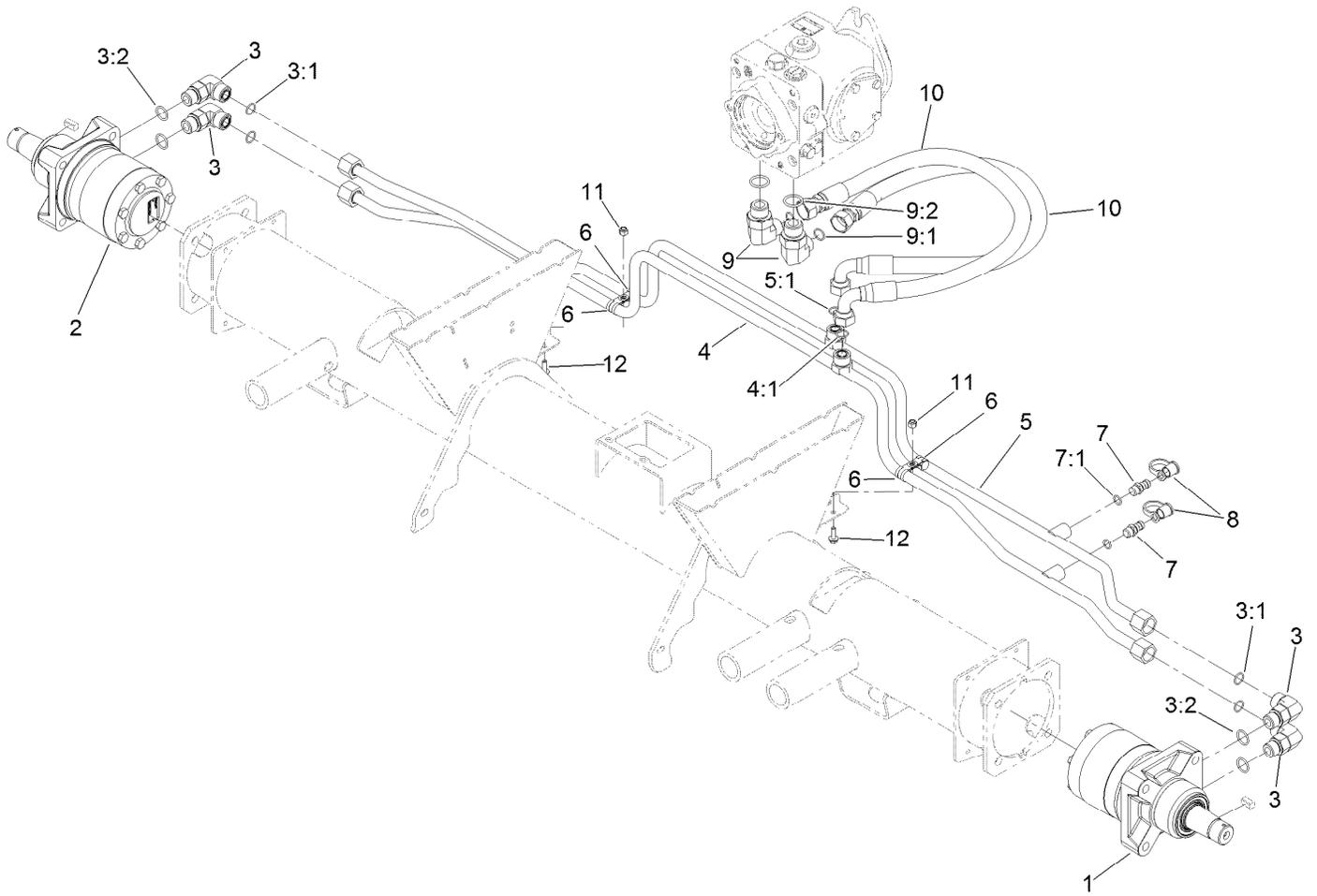

Traction Hydraulic Assembly

<i>Ref.</i>	<i>Part Number</i>	<i>Qty.</i>	<i>Description</i>
1	133-2935	1	Hydraulic Motor ASM
2	133-2934	1	Hydraulic Motor ASM
3	340-17	4	Fitting-Elbow, 90 DEG
3:1	237-65	1	O-Ring
3:2	237-80	1	O-Ring
4	125-1493	1	Tube ASM
4:1	237-65	1	O-Ring
5	125-1494	1	Tube ASM
5:1	237-65	1	O-Ring
6	2412-134	4	Clamp-R

<i>Ref.</i>	<i>Part Number</i>	<i>Qty.</i>	<i>Description</i>
7	59-7410	2	Fitting-Diagnostic
7:1	237-42	1	O-Ring
8	354-79	2	Cap-Dust
9	340-139	2	Fitting-Elbow 90
9:1	237-81	1	O-Ring
9:2	237-65	1	O-Ring
10	127-2300	2	Hose ASM
11	3296-42	2	Nut-Lock, NI
12	3234-4	2	Screw-HHF

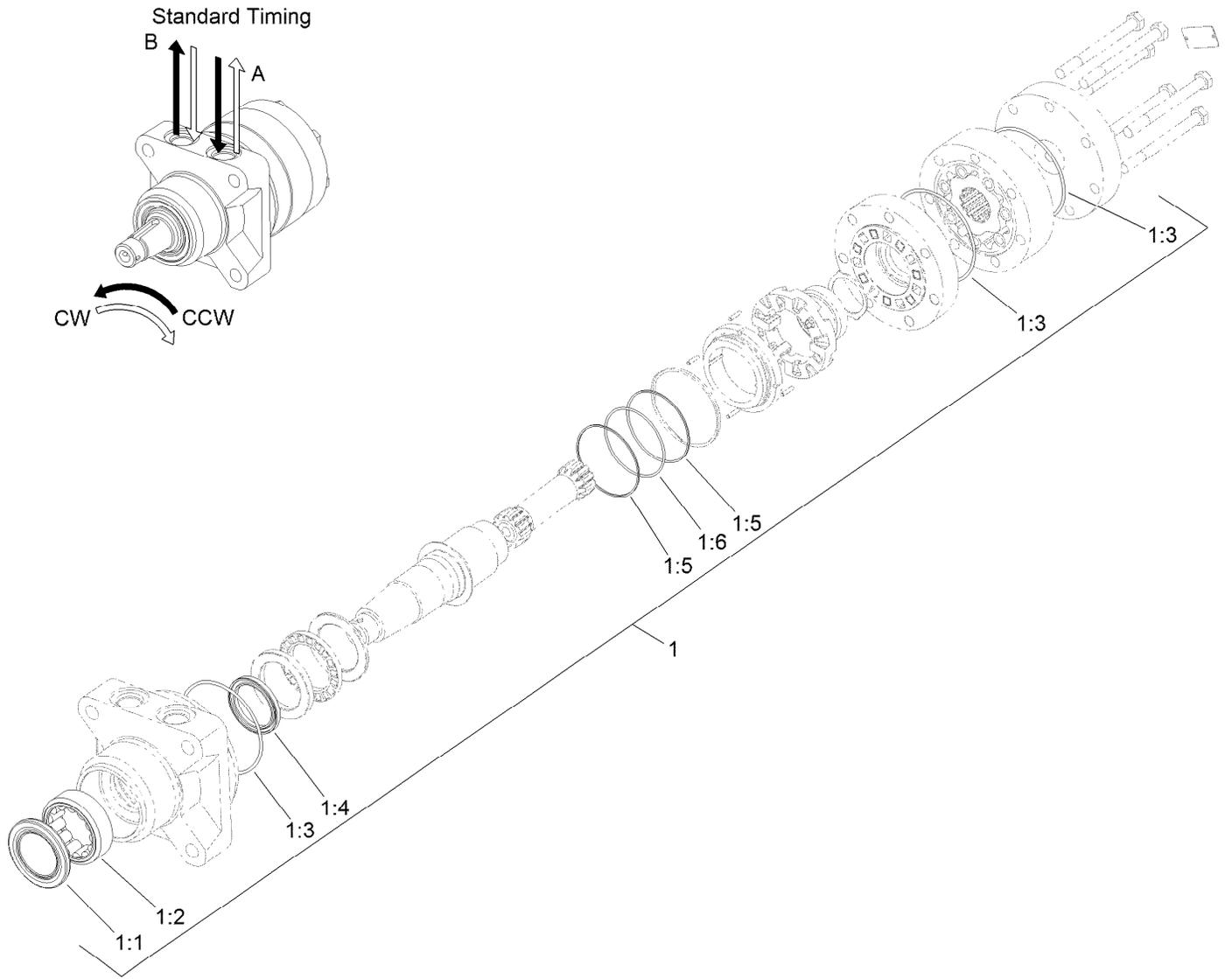

Hydraulic Motor Assembly No. 133-2935 (CCW)

Ref.	Part Number	Qty.	Description
1	120-6268	1	Seal Kit
1:1		1	Seal-Grease ●
1:2		1	Shell-Bearing ●
1:3		3	O-Ring ●
1:4		1	Seal-Shaft ●
1:5		2	Ring-Back Up ●
1:6		1	O-Ring ●

● Not serviced separately

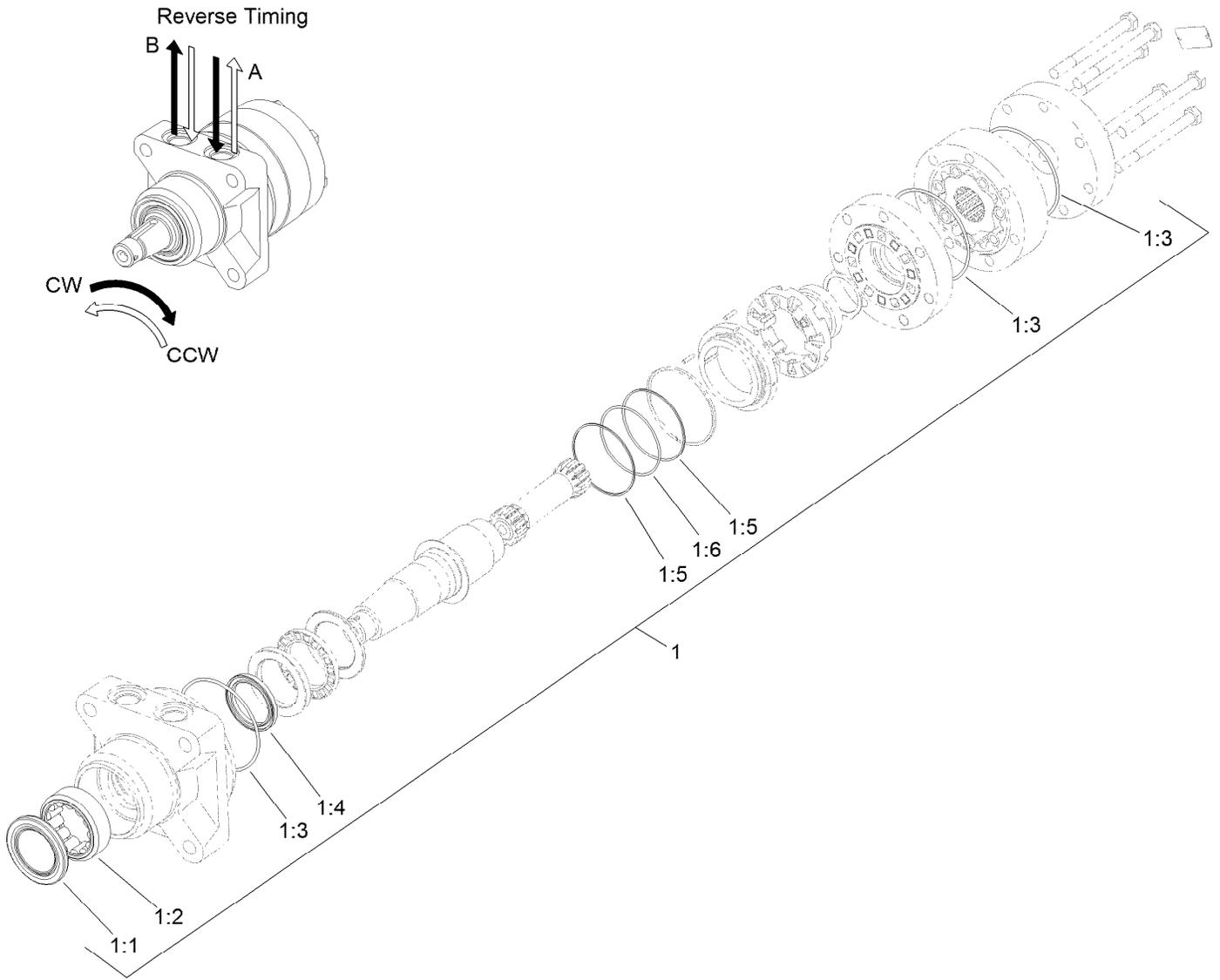

Hydraulic Motor Assembly No. 133-2934 (CW)

Ref.	Part Number	Qty.	Description
1	120-6268	1	Seal Kit
1:1		1	Seal-Grease ●
1:2		1	Shell-Bearing ●
1:3		3	O-Ring ●
1:4		1	Seal-Shaft ●
1:5		2	Ring-Back Up ●
1:6		1	O-Ring ●

● Not serviced separately

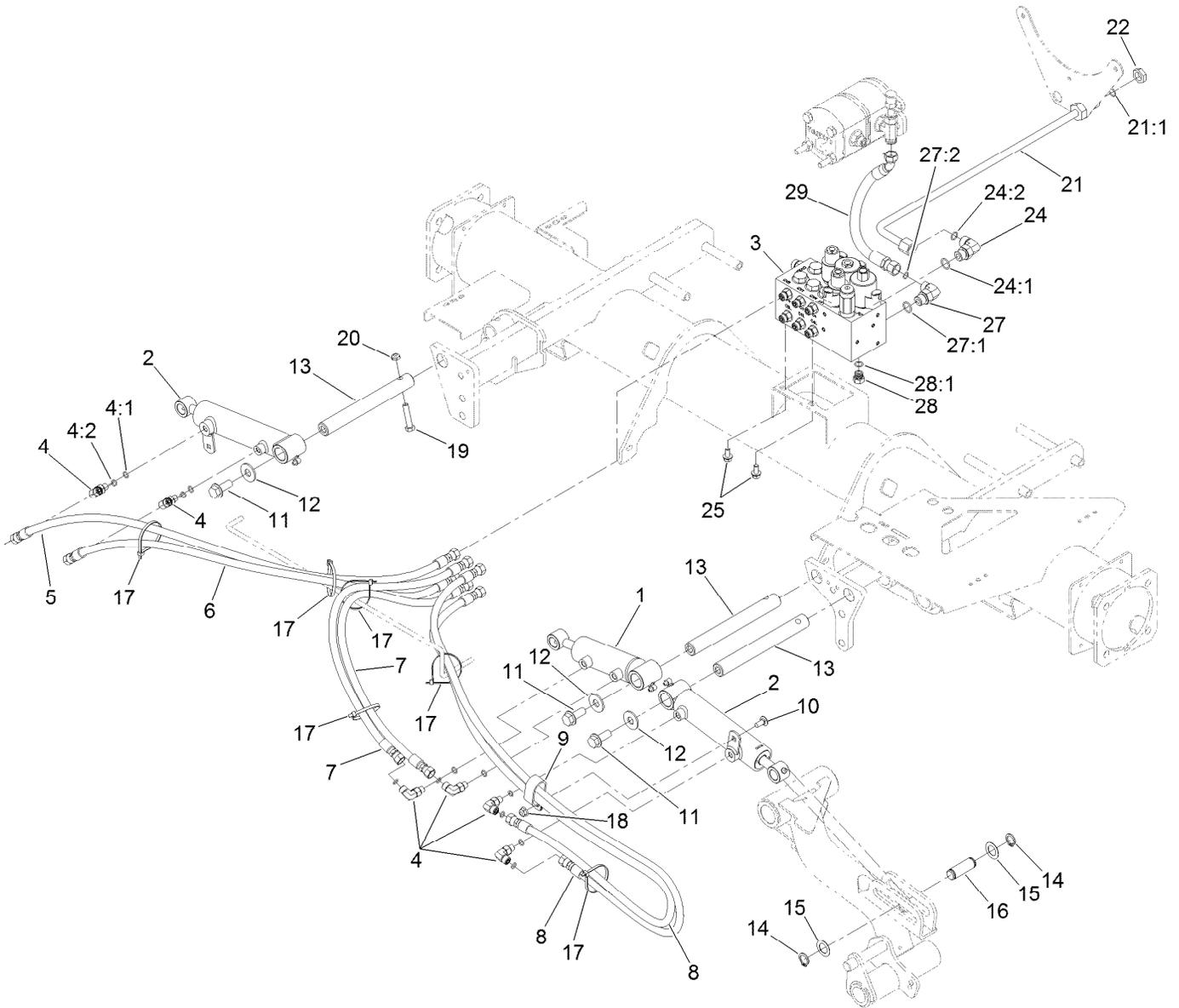

Front Lift Hydraulic Assembly

Ref.	Part Number	Qty.	Description	Ref.	Part Number	Qty.	Description
1	119-6988	1	HYD Cylinder ASM	16	104-0046	3	Pin-Slide, Cylinder
2	119-6987	2	HYD Cylinder ASM	17	3290-379	6	Tie-Cable
3	105-7577	1	HYD Lift Block Manifold ASM	18	104-8300	1	Nut-HF, NI
4	340-132	6	Fitting-Elbow, 90 DEG	19	323-9	3	Screw-HH
4:1	237-78	1	O-Ring	20	3296-59	3	Nut-Lock, NI
4:2	237-21	1	O-Ring	21	127-2477	1	Tube ASM
5	127-2498	1	Hose ASM	21:1	237-30	1	O-Ring
6	127-2499	1	Hose ASM	22	340-127	1	Nut-Bulkhead
7	127-2497	2	Hose ASM	24	340-98	1	Fitting-Elbow, 90 DEG
8	127-2496	2	Hose ASM	24:1	237-79	1	O-Ring
9	2412-137	1	Clamp-R, Double	24:2	237-30	1	O-Ring
10	3230-23	1	Bolt-CARR	25	3234-14	2	Screw-HHF
11	3234-38	3	Screw-HHF	27	340-18	1	Fitting-HYD, 90 DEG
12	3256-6	3	Washer-Flat	27:1	237-79	1	O-Ring
13	117-0148	3	Pin-Cylinder	27:2	237-22	1	O-Ring
14	32120-93	6	Ring-Retaining	28	353-508	1	Plug-HH
15	3-6498	6	Washer-Thrust	28:1	237-42	1	O-Ring
				29	127-2535	1	Hose-ASM

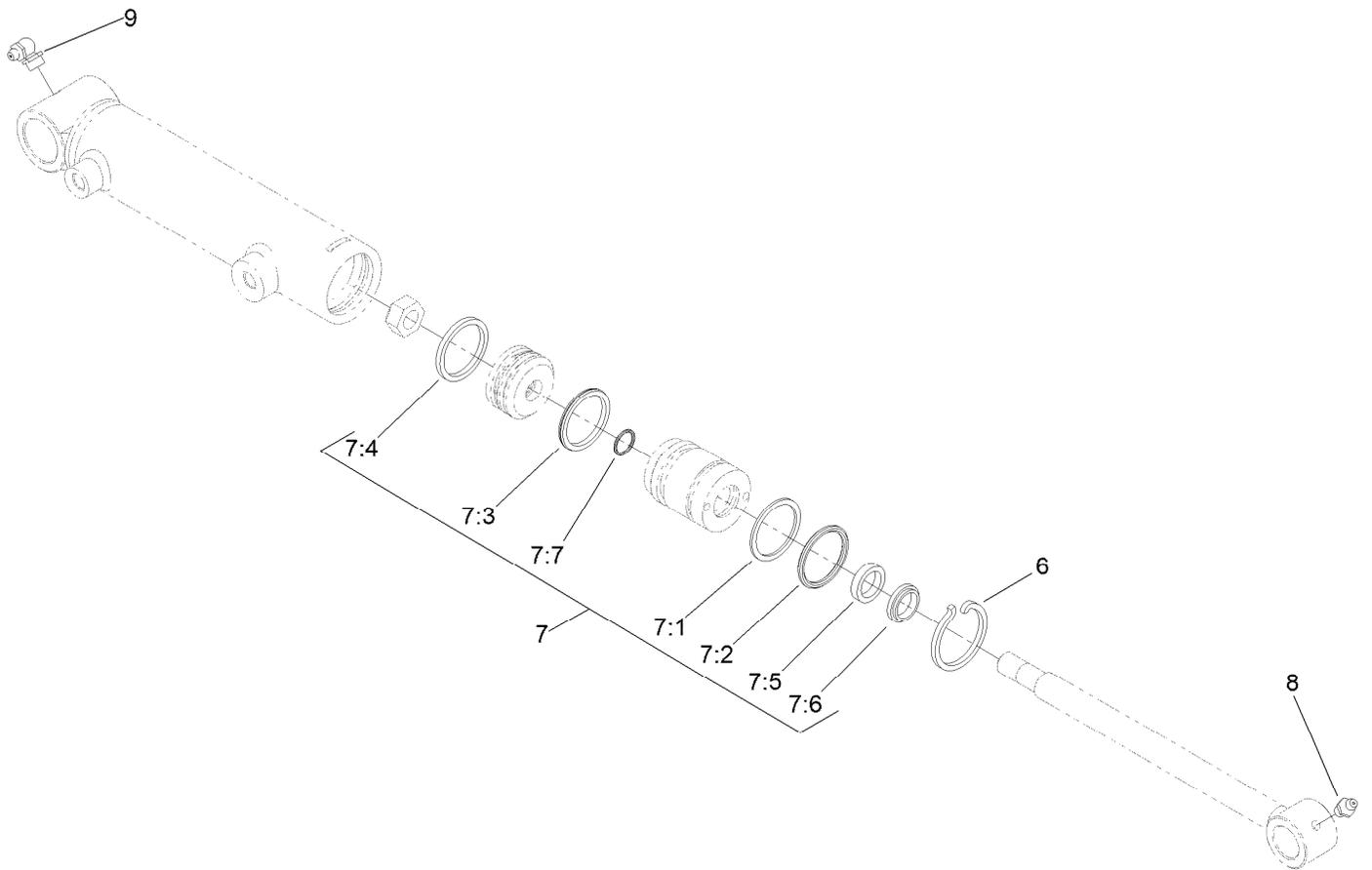

Hydraulic Cylinder Assembly No. 119-6988

Ref.	Part Number	Qty.	Description
6	84-1680	1	Ring-Retaining
7	119-6992	1	Seal Kit
7:1		1	O-Ring ●
7:2		1	Backup ●
7:3		1	Bp Seal ●
7:4		1	Wear Ring-Ht ●
7:5		1	Bs Seal ●
7:6		1	Dust Seal-Dt ●
7:7		1	O-Ring ●
8	302-5	1	Fitting-Grease
9	302-33	1	Fitting-Grease

● Not serviced separately

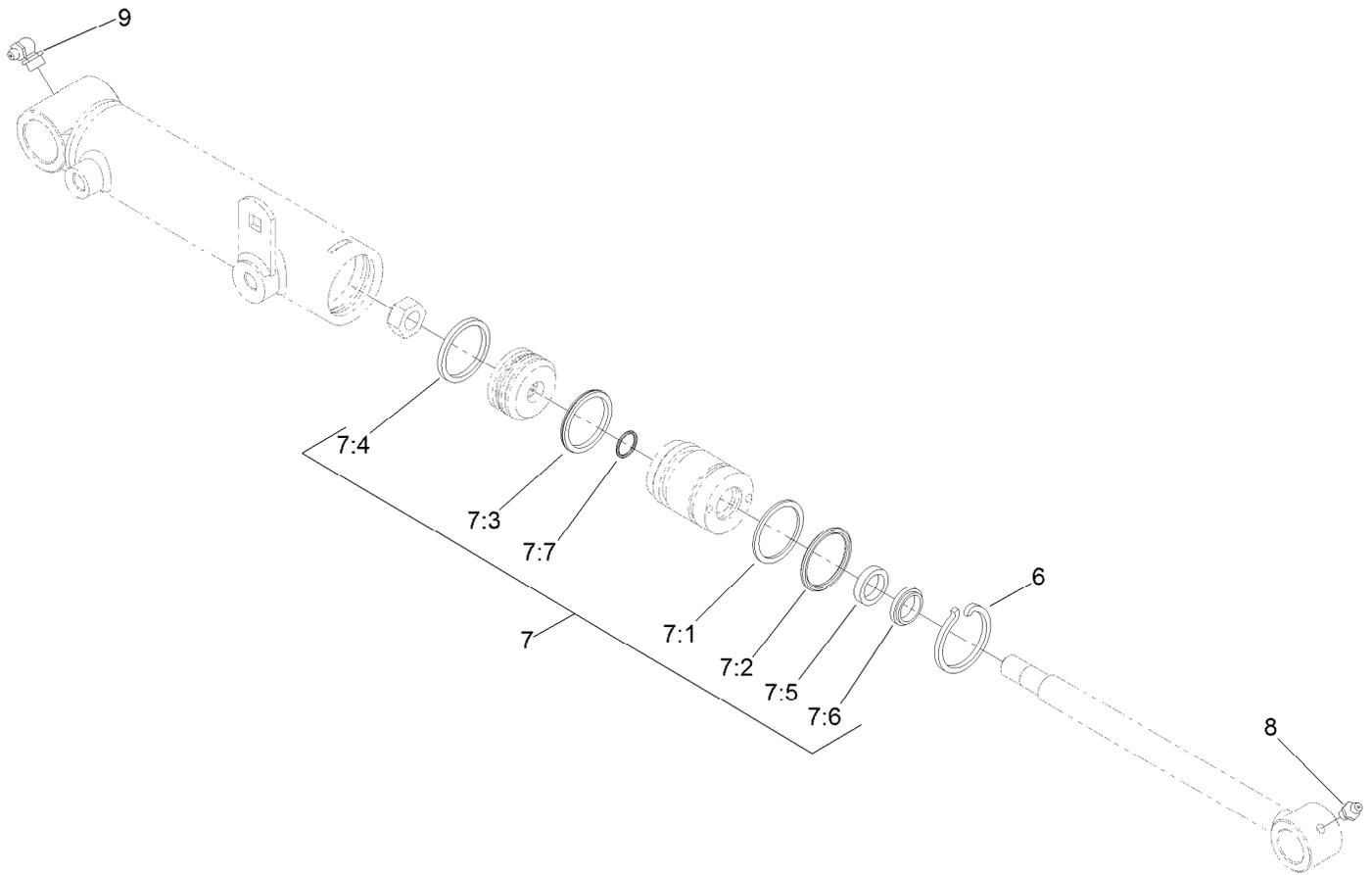

Hydraulic Cylinder Assembly No. 119-6987

Ref.	Part Number	Qty.	Description
6	84-1680	1	Ring-Retaining
7	119-6992	1	Seal Kit
7:1		1	O-Ring ●
7:2		1	Backup ●
7:3		1	Bp Seal ●
7:4		1	Wear Ring-Ht ●
7:5		1	Bs Seal ●
7:6		1	Dust Seal-Dt ●
7:7		1	O-Ring ●
8	302-5	1	Fitting-Grease
9	302-33	1	Fitting-Grease

● Not serviced separately

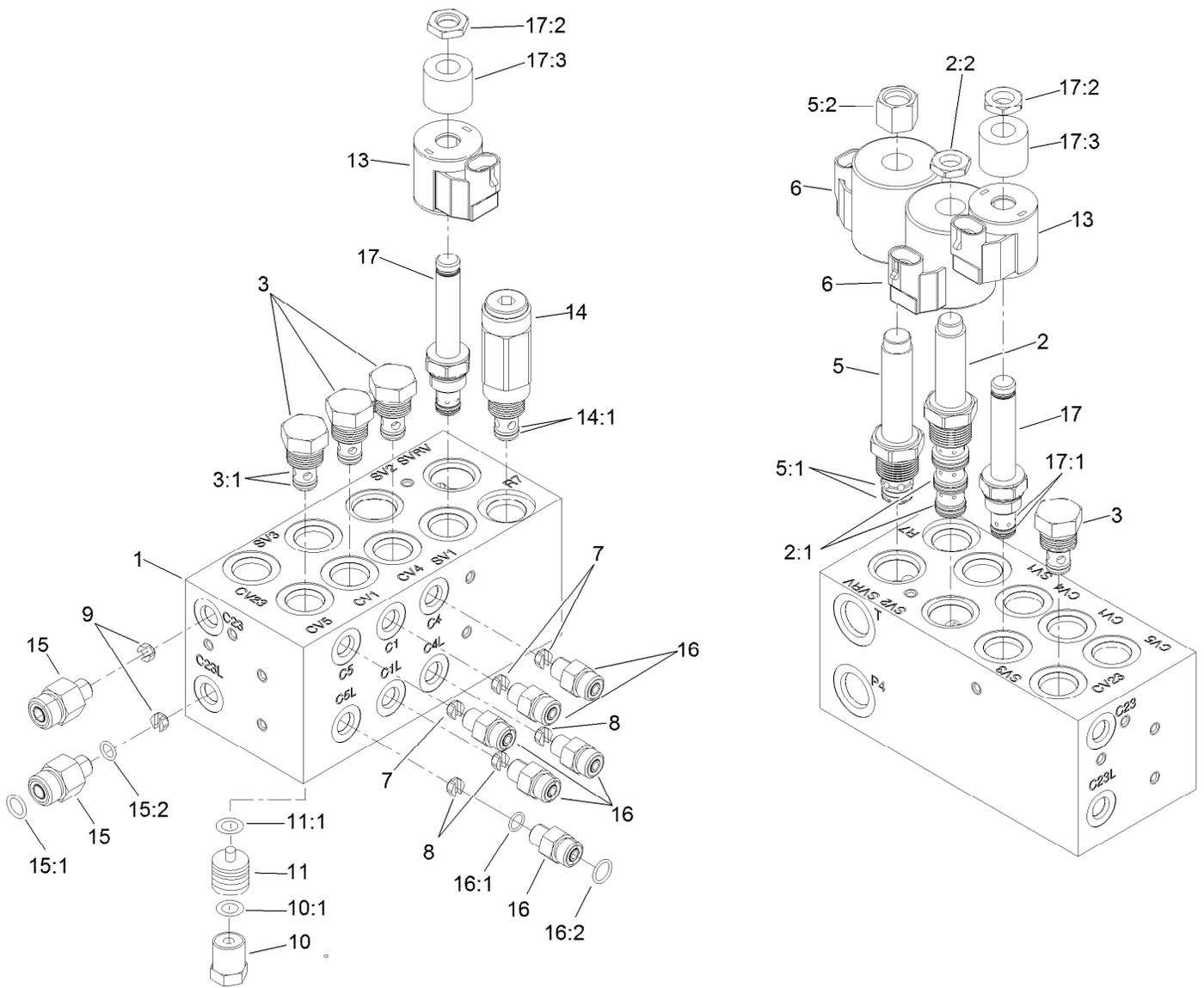

Hydraulic Manifold Block Assembly No. 105-7577

Ref.	Part Number	Qty.	Description
1		1	Block-Manifold ■
2	110-8906	1	Valve-Solenoid
2:1	110-8908	1	Spool Valve Seal Kit
2:2	110-2634	1	Nut-Coil
3	110-9006	4	Valve-Check
3:1	105-9156	1	Seal Kit
5	110-8905	1	Valve-Relief, Solenoid
5:1	110-6316	1	Seal Kit
5:2	130-8180	1	Nut-Coil (9/16-24 Unef-2B)
6	110-6344	2	Coil-12V, DC
7	110-8904	3	Orifice-Control, Flow (0.028)
7	125-8849	3	Orifice-Flow Control ●
8	110-8903	3	Orifice-Control, Flow (0.055)
9	110-8902	2	Orifice-Control, Flow (0.046)
10	354-70	4	Plug-Hex, Hollow
10:1	237-80	1	O-Ring

Ref.	Part Number	Qty.	Description
11	110-8901	4	Piston-Pilot
11:1	110-8900	1	O-Ring
13	110-0497	2	Coil-Solenoid
14	110-8899	1	Valve-Relief
14:1	105-9156	1	Seal Kit
15	340-88	2	Fitting-Straight
15:1	237-22	1	O-Ring
15:2	237-78	1	O-Ring
16	340-92	6	Fitting-Straight
16:1	237-78	1	O-Ring
16:2	237-21	1	O-Ring
17	110-8898	2	Valve-Solenoid
17:1	107-7527	1	Seal Kit
17:2	110-2634	1	Nut-Coil
17:3	110-8909	1	Spacer-Coil

● Optional Equipment

■ Not serviced separately

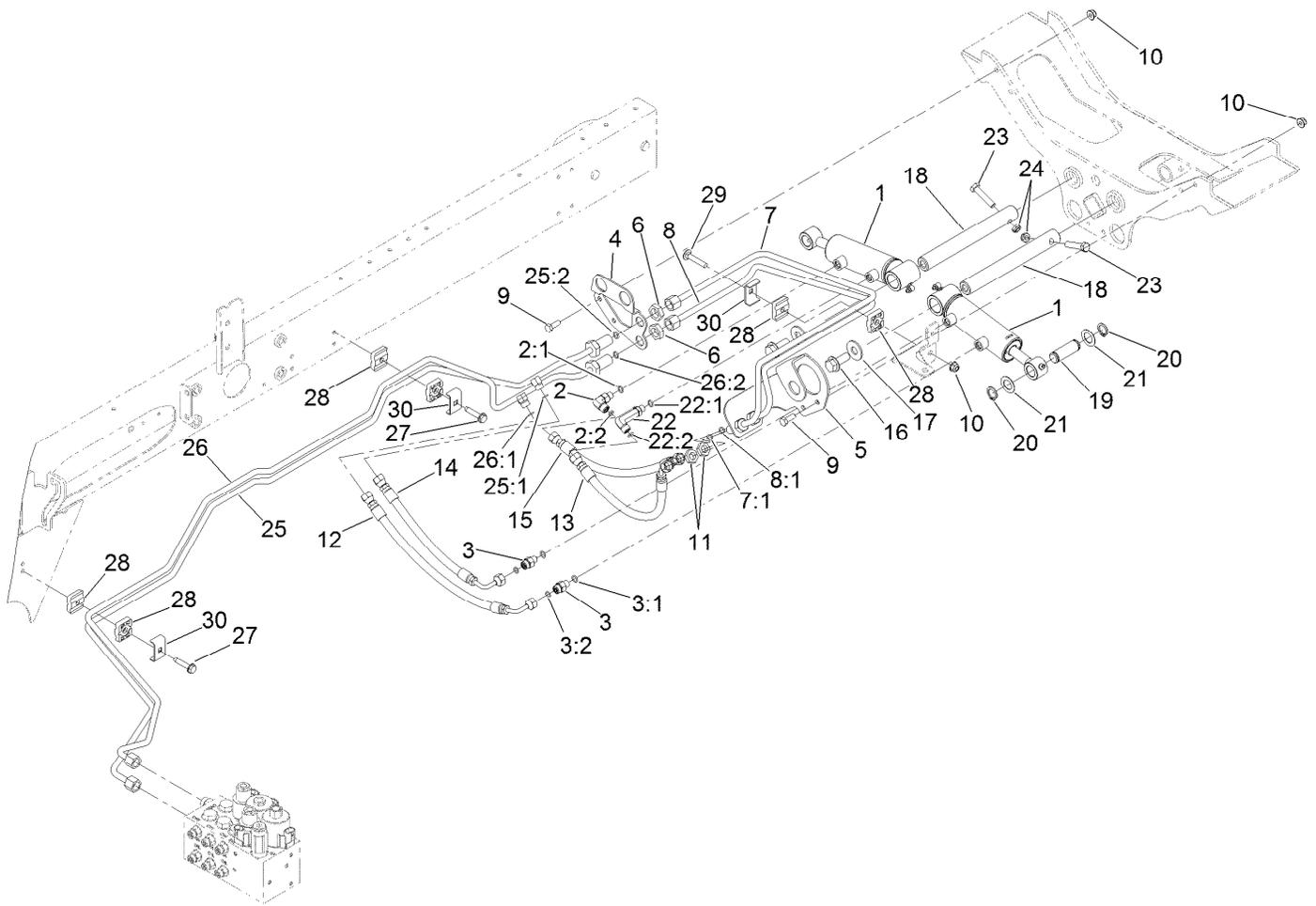

Rear Lift Hydraulic Assembly

<i>Ref.</i>	<i>Part Number</i>	<i>Qty.</i>	<i>Description</i>	<i>Ref.</i>	<i>Part Number</i>	<i>Qty.</i>	<i>Description</i>
1	119-6988	2	HYD Cylinder ASM	16	3234-38	2	Screw-HHF
2	340-132	1	Fitting-Elbow, 90 DEG	17	3256-6	2	Washer-Flat
2:1	237-78	1	O-Ring	18	117-0148	2	Pin-Cylinder
2:2	237-21	1	O-Ring	19	104-0046	2	Pin-Slide, Cylinder
3	340-92	2	Fitting-Straight	20	32120-93	4	Ring-Retaining
3:1	237-78	1	O-Ring	21	3-6498	4	Washer-Thrust
3:2	237-21	1	O-Ring	22	100-7695	1	Fitting-Elbow 90
4	127-2568-01	1	Bracket-Bulkhead, RH	22:1	237-78	1	O-Ring
5	127-2567-01	1	Bracket-Bulkhead, LH	22:2	237-21	1	O-Ring
6	340-70	2	Nut-Lock	23	323-9	2	Screw-HH
7	133-2987	1	Tube-ASM	24	3296-59	2	Nut-Lock, NI
7:1	237-21	1	O-Ring	25	125-1489	1	Tube ASM
8	133-2986	1	Tube-ASM	25:1	237-21	1	O-Ring
8:1	237-21	1	O-Ring	25:2	237-22	1	O-Ring
9	322-4	4	Screw-HH	26	125-1488	1	Tube ASM
10	104-8300	5	Nut-HF, NI	26:1	237-21	1	O-Ring
11	340-78	2	Nut-Lock	26:2	237-22	1	O-Ring
12	110-0930	1	Hose-HYD	27	32144-57	2	Screw
13	110-8966	1	Hose-HYD	28	56-7973	6	Clamp-Tube
14	110-0929	1	Hose-HYD	29	3230-5	1	Bolt-CARR
15	110-0931	1	Hose-HYD	30	119-1418	3	Plate-Clamp, Short

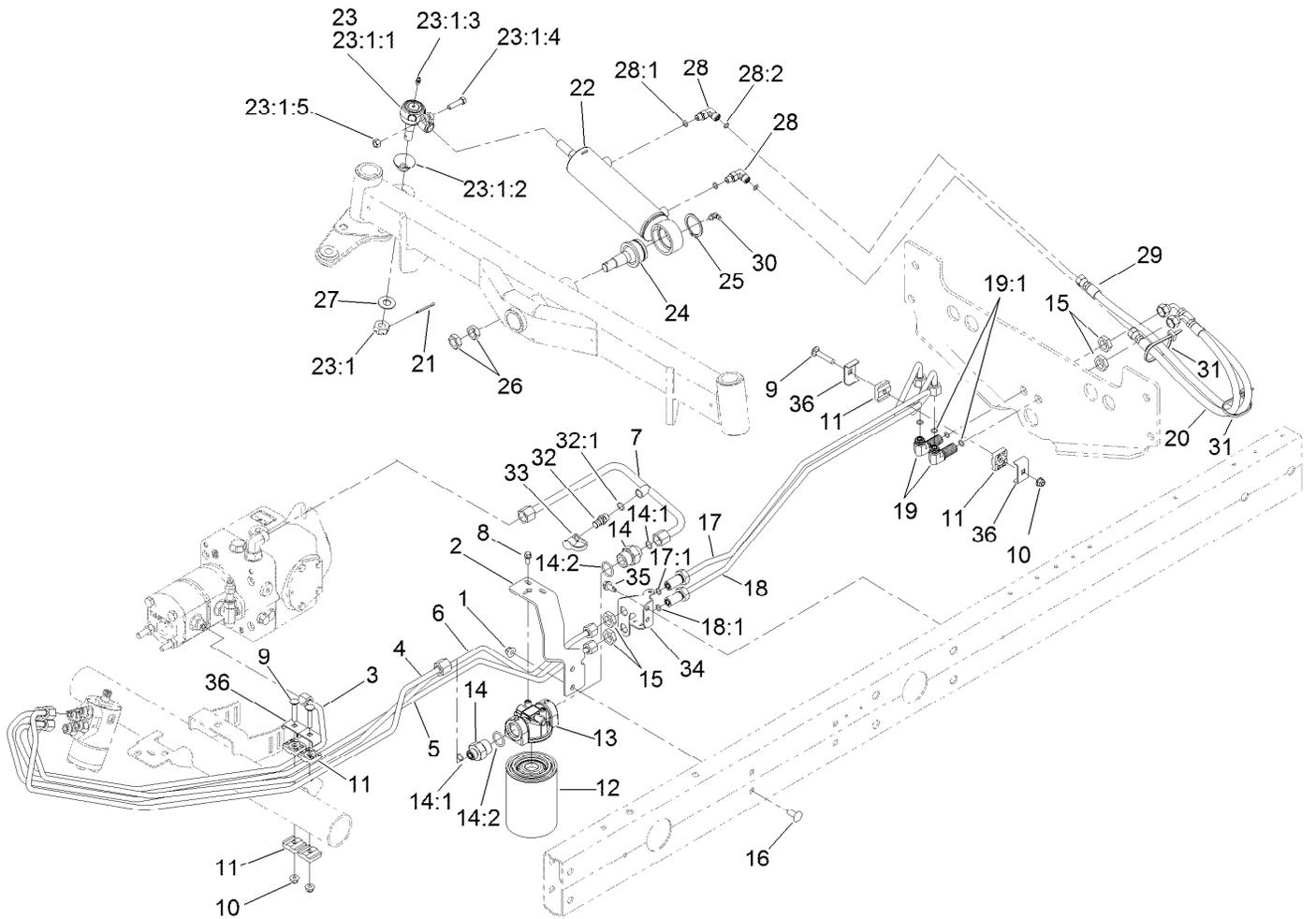

Steering Hydraulic Assembly

Ref.	Part Number	Qty.	Description	Ref.	Part Number	Qty.	Description
1	104-8301	2	Nut-HF, NI	17	127-2337	1	Tube ASM
2	110-0906-01	1	Support-Filter, Oil	17:1	237-22	1	O-Ring
3	127-2500	1	Tube-Assembly	18	127-2338	1	Tube ASM
4	108-1711	1	Tube-HYD	18:1	237-22	1	O-Ring
5	127-2335	1	Tube ASM	19	340-154	2	Union-Bulkhead
6	127-2336	1	Tube ASM	19:1	237-22	2	O-Ring
7	125-1437	1	Tube ASM	20	110-0928	1	Hose-HYD
8	3234-33	2	Screw-HHF	21	3272-12	1	Pin-Cotter
9	3230-5	3	Bolt-CARR	22	110-9035	1	HYD Cylinder ASM
10	104-8300	3	Nut-HF, NI	23	106-6895-03	1	Ball Joint ASM
11	56-7973	6	Clamp-Tube	23:1		1	Joint-Ball ●
12	86-3010	1	Filter-Oil	23:1:1	32136-13	1	Nut-SHH
13	117-5820	1	Head-Filter	23:1:2	106-6896	1	Seal
14	100-4240	2	Fitting-STR	23:1:3	302-5	1	Fitting-Grease
14:1	237-30	1	O-Ring	23:1:4	3210-7	1	Screw-HH
14:2	237-81	1	O-Ring	23:1:5	32152-5	1	Nut-Hex
15	340-70	4	Nut-Lock	24	106-6774	1	Joint-Ball
16	3231-27	2	Screw-CARR	25	32151-104	1	Ring-Retaining, External

● Not serviced separately

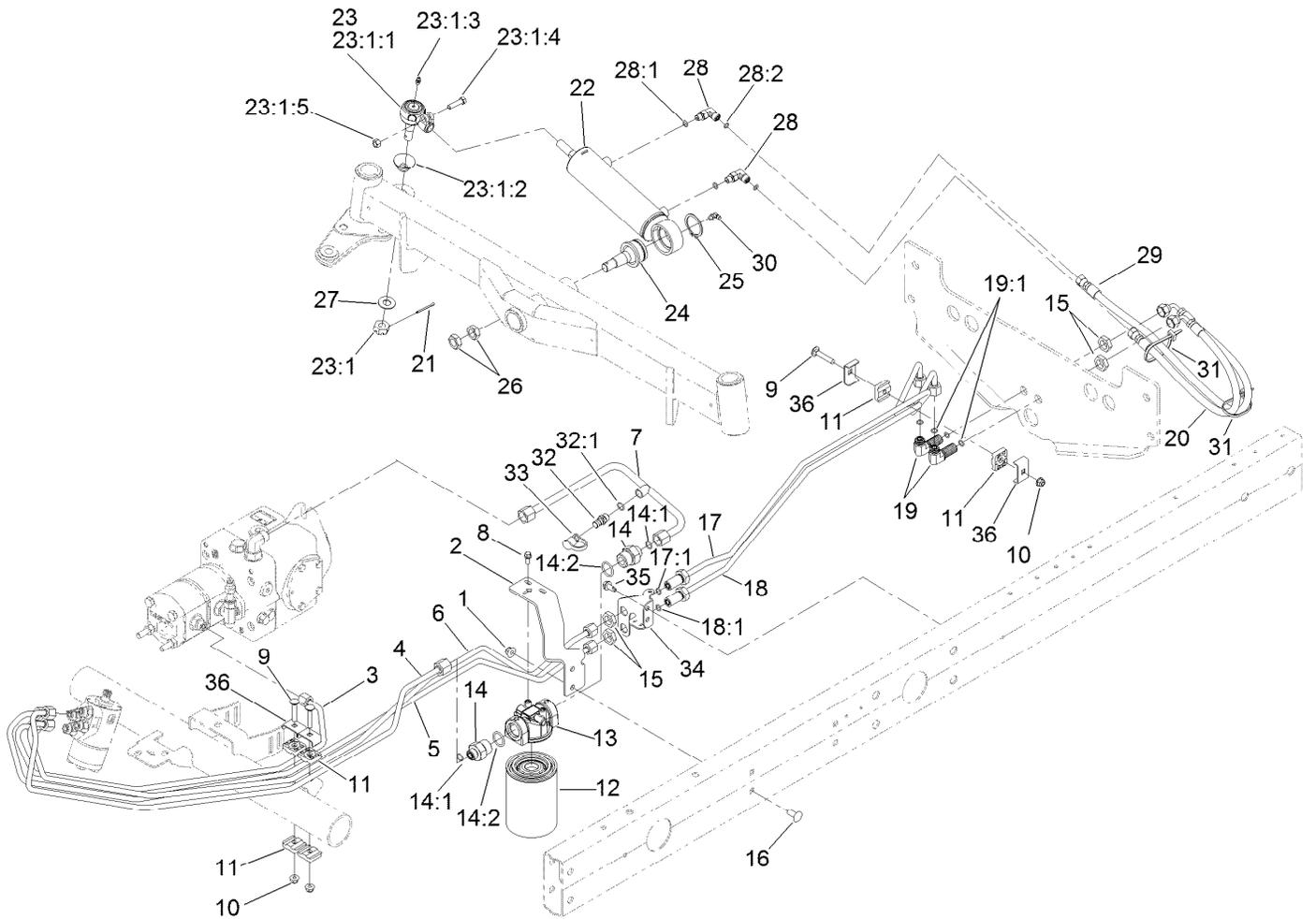

Steering Hydraulic Assembly (continued)

<i>Ref.</i>	<i>Part Number</i>	<i>Qty.</i>	<i>Description</i>	<i>Ref.</i>	<i>Part Number</i>	<i>Qty.</i>	<i>Description</i>
26	3220-6	2	Nut-Jam	31	3290-378	2	Tie-Cable
27	69-8980	1	Washer	32	59-7410	1	Fitting-Diagnostic
28	340-132	2	Fitting-Elbow, 90 DEG	32:1	237-42	1	O-Ring
28:1	237-78	1	O-Ring	33	354-79	1	Cap-Dust
28:2	237-21	1	O-Ring	34	127-2341-01	1	Bracket-Bulkhead, Steer
29	110-0973	1	Hose-HYD	35	32104-32	2	Screw-HWH
30	302-40	1	Fitting-Grease, 90 DEG	36	119-1418	4	Plate-Clamp, Short

● Not serviced separately

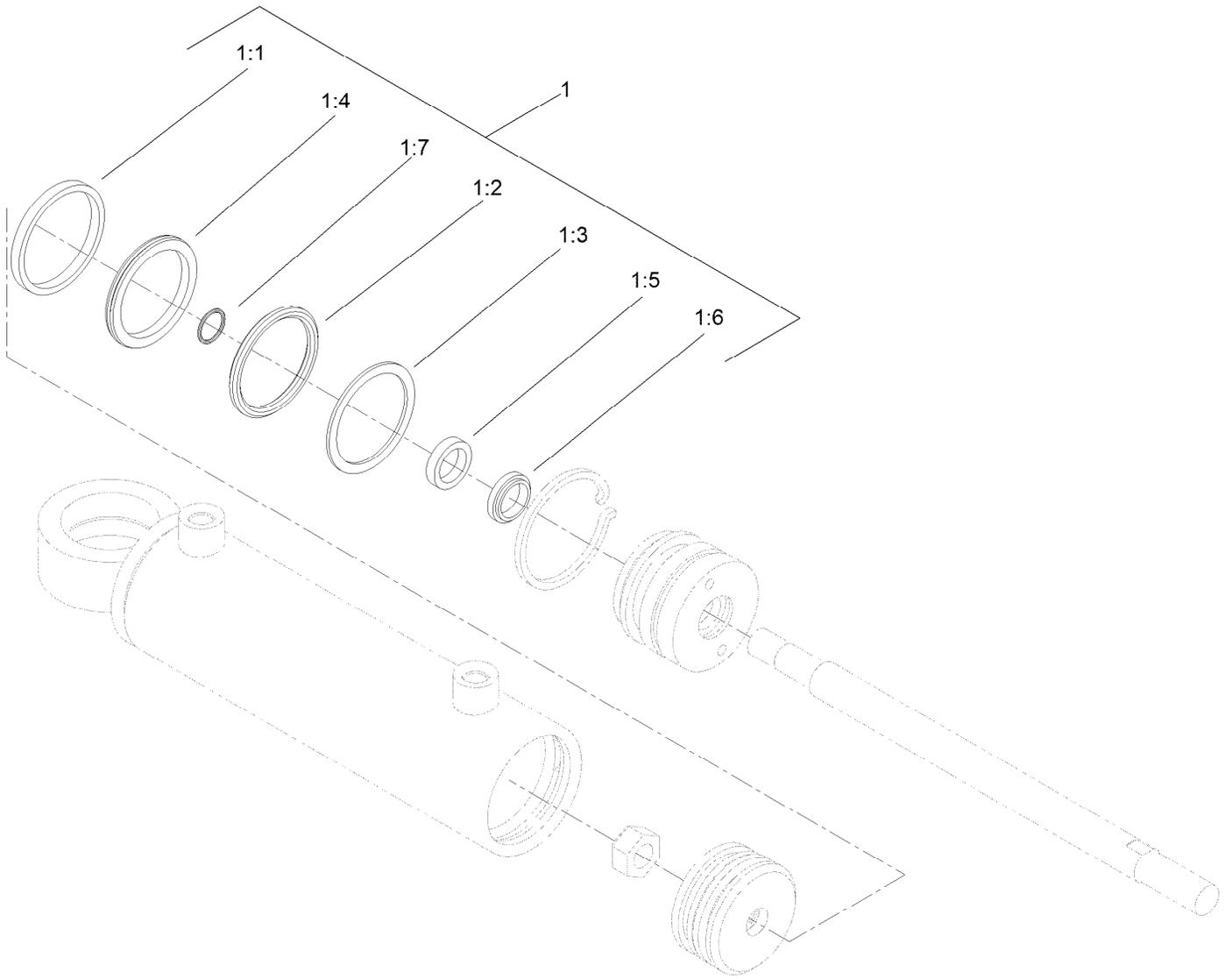

Hydraulic Cylinder Assembly No. 110-9035

<i>Ref.</i>	<i>Part Number</i>	<i>Qty.</i>	<i>Description</i>
1	114-8875	1	Seal Kit
1:1		1	Wear Ring ●
1:2		1	O-Ring ●
1:3		1	Backup ●
1:4		1	Bp Seal ●
1:5		1	Bs Seal ●
1:6		1	Dust Seal ●
1:7		1	O-Ring ●

● Not serviced separately

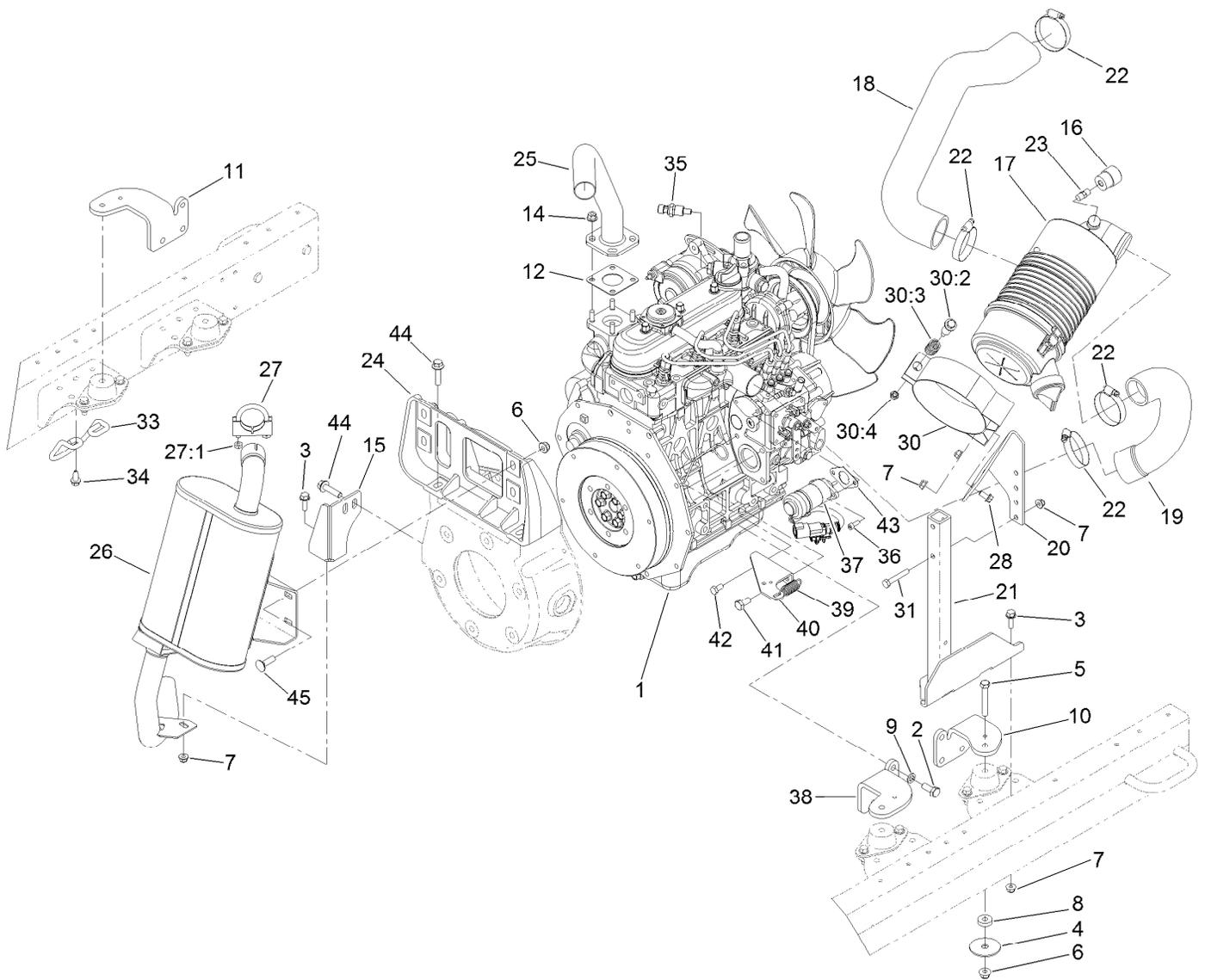

Engine, Air Cleaner and Muffler Assembly

Ref.	Part Number	Qty.	Description	Ref.	Part Number	Qty.	Description
1	138-6909	1	Engine-Kubota, D1105	23	94-1416	1	Adapter-Indicator
2	43-0090	12	Screw-HH	24	127-2550	1	Bracket-Muffler
3	3234-29	4	Screw-HHF	25	127-2698	1	Header-Exhaust
4	87-5100	4	Washer-Snubbing	26	127-2503	1	Muffler-Exhaust
5	323-12	4	Screw-HH	27	2112-9	1	Clamp
6	104-8301	8	Nut-HF, NI	27:1	32128-20	2	Nut-HF
7	104-8300	8	Nut-HF, NI	28	3234-14	2	Screw-HHF
8	62-6660	4	Spacer	30	100-4825	1	Band-Mounting, Air Cleaner
9	48-9590	12	Washer-Lock	30:2	94-3653	1	Bolt
10	115-8066-03	2	Mount-Engine	30:3	94-3654	1	Spring
11	115-8063-03	1	Mount-Engine, RH	30:4	48-9510	1	Nut
12	99-8343	1	Gasket-Muffler	31	322-10	2	Screw-HH
14	104-2612	4	Nut-HF	33	127-2612	1	Guard-Pipe, Tail
15	127-2428-03	1	Tab-Tailpipe	34	32104-32	2	Screw-HWH
16	93-9164	1	Indicator-Mini	35	119-4478	1	Sender-Temperature
17	106-5277	1	Air Cleaner ASM	36	105-2409	2	Screw-HSH
18	127-2696	1	Hose-Formed	37	125-1562	1	Actuator-Fuel
19	117-5164	1	Hose-Formed	38	115-8068-03	1	Mount-Engine LH
20	127-2695-03	1	Bracket-Air Cleaner	39	107-1045	1	Spring-Extension
21	121-5610-03	1	Stand-Air Cleaner	40	125-1472-03	1	Brkt-Spring, Throttle
22	2412-130	4	Clamp-Hose	41	63-7790	1	Screw-Cap

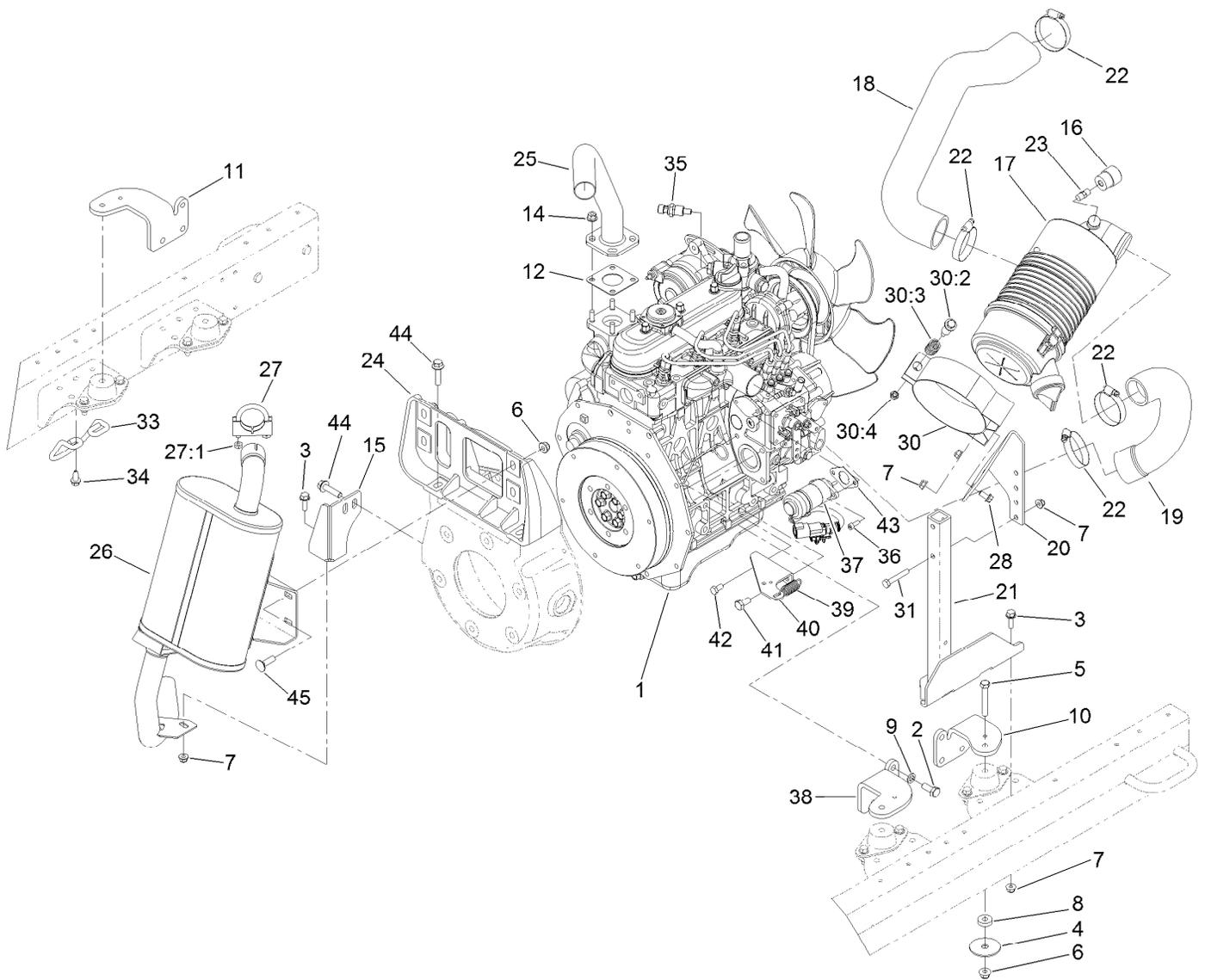

Engine, Air Cleaner and Muffler Assembly (continued)

<i>Ref.</i>	<i>Part Number</i>	<i>Qty.</i>	<i>Description</i>	<i>Ref.</i>	<i>Part Number</i>	<i>Qty.</i>	<i>Description</i>
42	33114-016	1	Screw-HH	44	114-4681	6	Screw-HHF
43	127-2507	1	Gasket-Actuator, Fuel	45	3231-25	4	Bolt-CARR

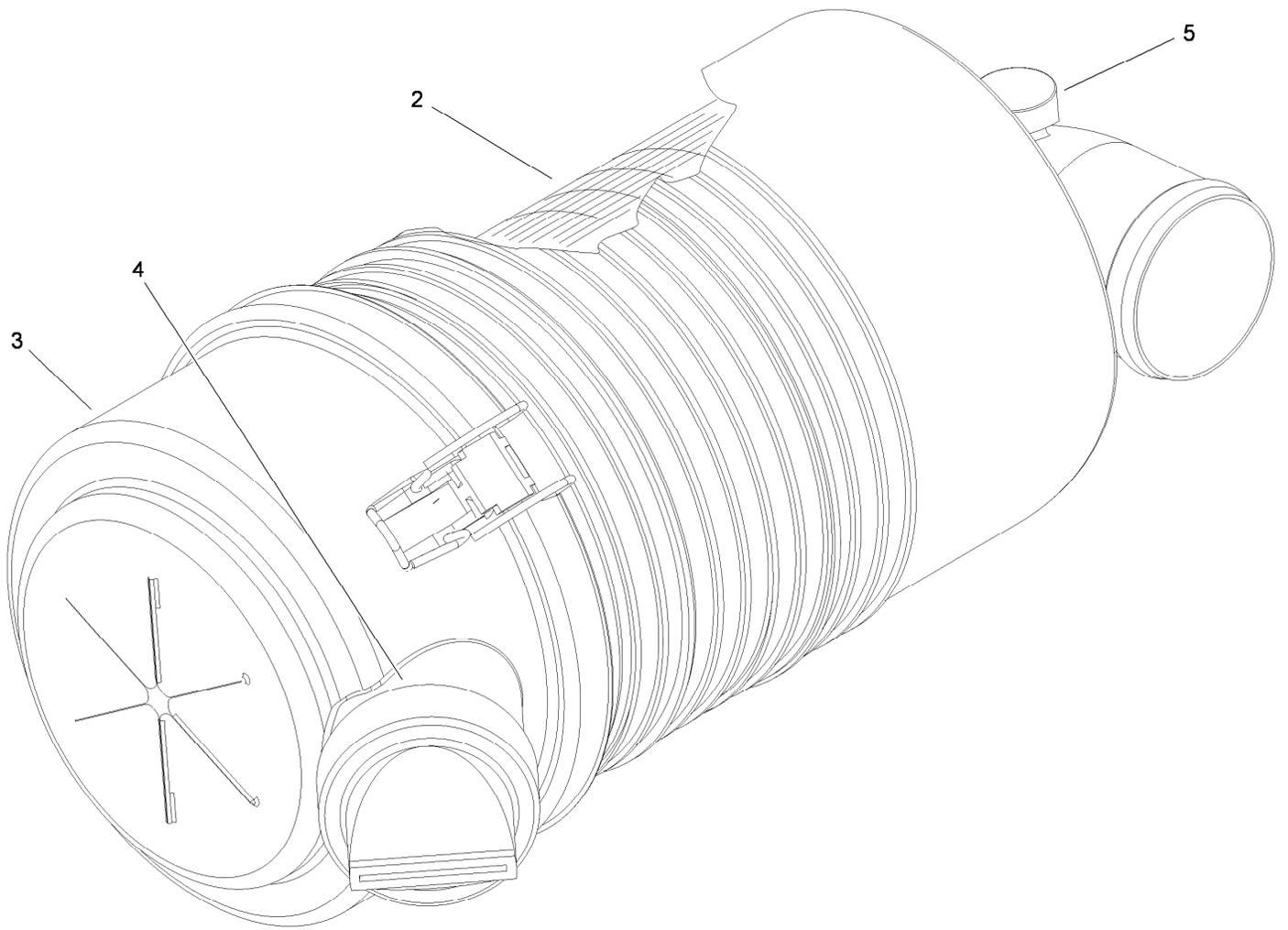

Air Cleaner Assembly No. 106-5277

<i>Ref.</i>	<i>Part Number</i>	<i>Qty.</i>	<i>Description</i>
2	108-3810	1	Filter-Air
3	98-9771	1	Cover ASM
4	87-9400	1	Valve-Vacuator
5	285-17	1	Plug-Pipe

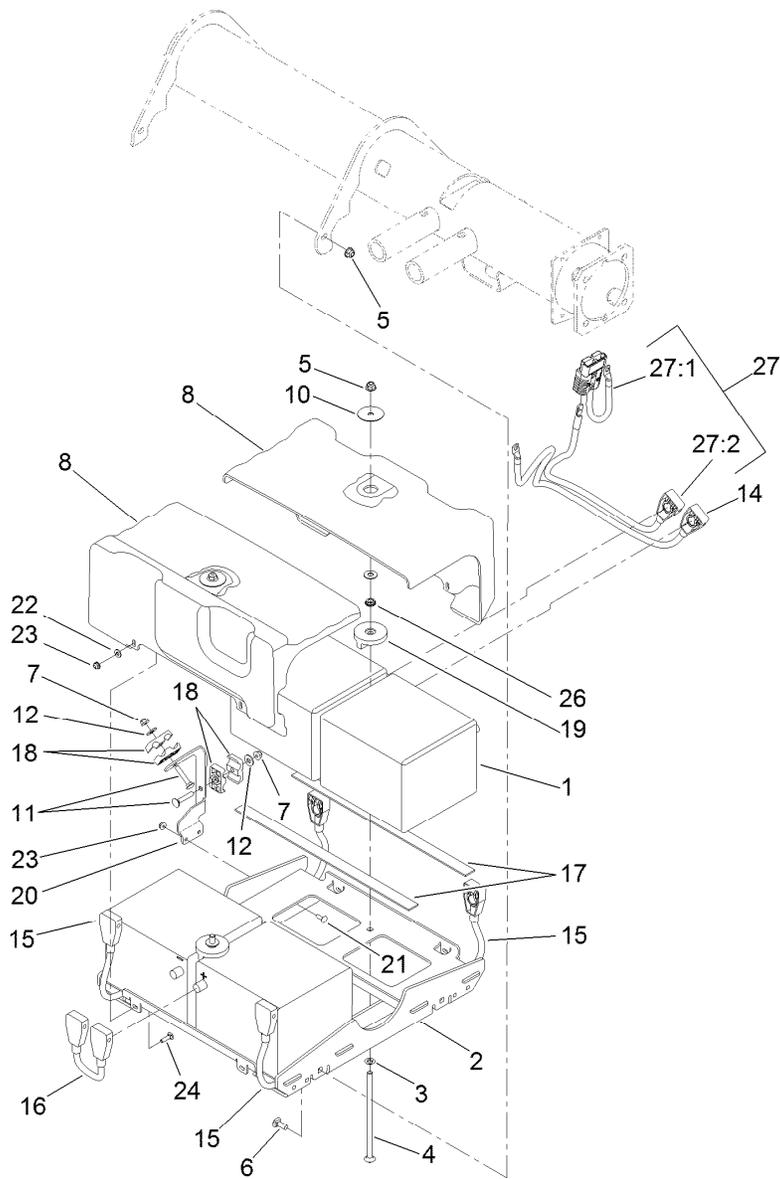

48 Volt Battery Assembly

<i>Ref.</i>	<i>Part Number</i>	<i>Qty.</i>	<i>Description</i>	<i>Ref.</i>	<i>Part Number</i>	<i>Qty.</i>	<i>Description</i>
1	121-7185	4	Battery-Wet	16	122-0134	1	Jumper-Cable-Battery (Positive)
2	127-2413-01	1	Tray	17	127-2306	4	Strip-Foam
3	107-3154	2	Nut-Push	18	56-7971	4	Clamp-Tube
4	120-4743	2	Screw-CARR	19	127-2393	2	Hold Down-Battery
5	104-8301	6	Nut-HF, NI	20	127-2517-01	1	Bracket-Cable
6	3231-2	4	Bolt-CARR	21	3229-1	2	Screw-CARR
7	104-8300	2	Nut-HF, NI	22	3256-78	4	Washer-Flat
8	127-2560	2	Cover-Battery	23	104-7201	6	Nut-HF, NI
10	120-2229	2	Washer	24	3229-2	4	Screw-CARR
11	3230-5	2	Bolt-CARR	26	3217-7	2	Nut-Hex
12	3256-3	2	Washer-Flat	27	122-0449	1	Cable-Battery
14	122-0268	1	Negative Battery Cable ASM	27:1	122-0267	1	Positive Battery Cable ASM
15	122-0133	2	Positive Battery Cable ASM	27:2	122-0319	1	Positive Battery Cable ASM

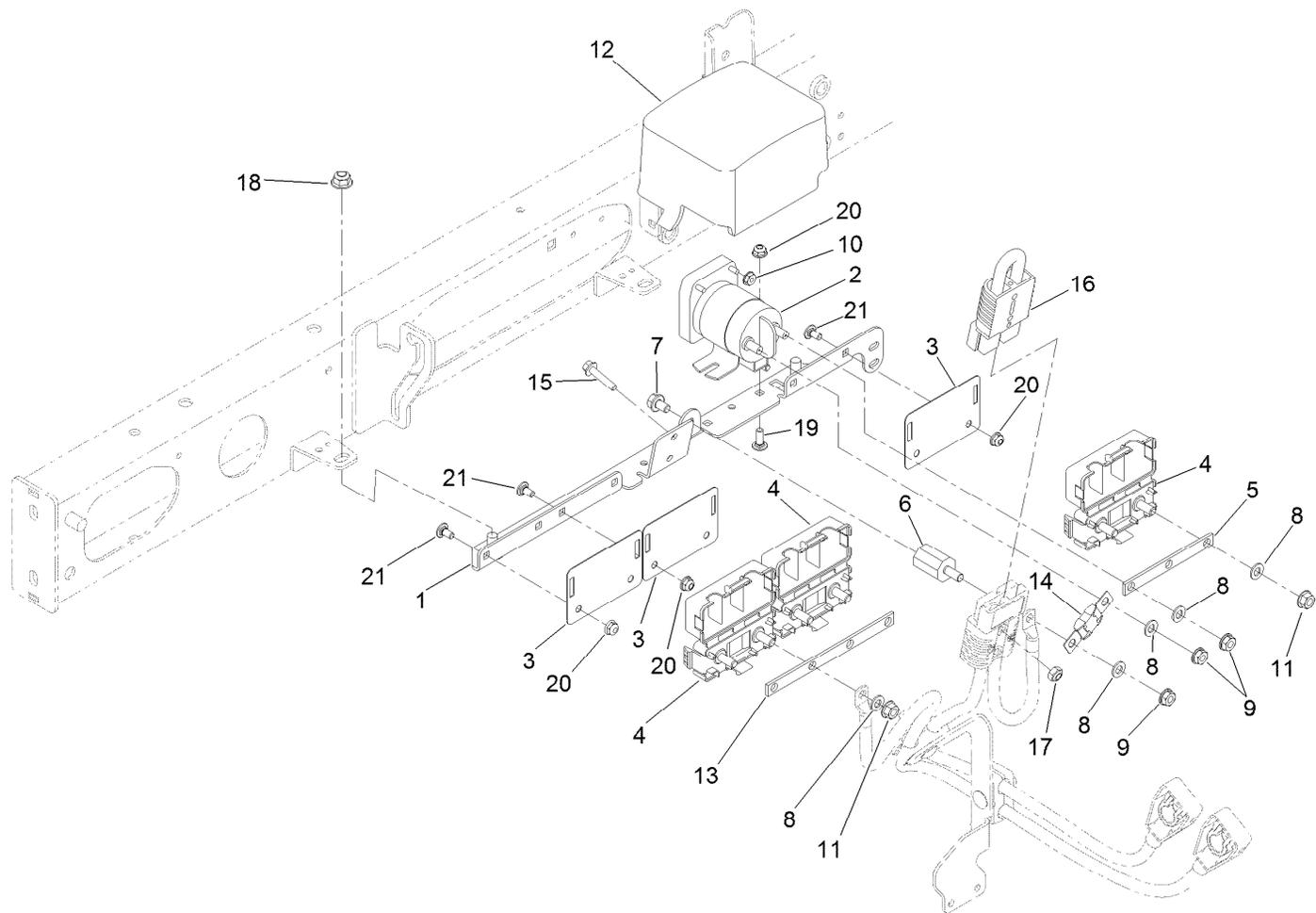

48 Volt Contactor Assembly

<i>Ref.</i>	<i>Part Number</i>	<i>Qty.</i>	<i>Description</i>	<i>Ref.</i>	<i>Part Number</i>	<i>Qty.</i>	<i>Description</i>
1	127-2643	1	Bracket	12	127-2327	1	Cover-Electrical
2	104-7136	1	Contactora-Trombetta	13	127-2372	1	Strap-Jumper
3	127-2325	3	Bracket-Fuse	14	127-2305	1	Fuse-250 Amp
4	114-3318	3	Holder-Fuse, Mega	15	127-8639	2	Screw-HHF
5	127-2319	1	Strap-Jumper	16	122-0136	1	Cable-Battery, Positive Jumper ASM
6	107-0286	1	Isolator	17	3296-16	2	Nut-Lock, NI
7	100-1719	1	Screw-Flange	18	104-8301	2	Nut-HF, NI
8	107-0394	9	Washer-Flat	19	1-807512	2	Bolt-CARR
9	107-0380	3	Nut-HHF	20	104-7201	8	Nut-HF, NI
10	32149-8	2	Nut-Keps	21	3229-10	6	Screw-CARR
11	127-2371	6	Nut-HF				

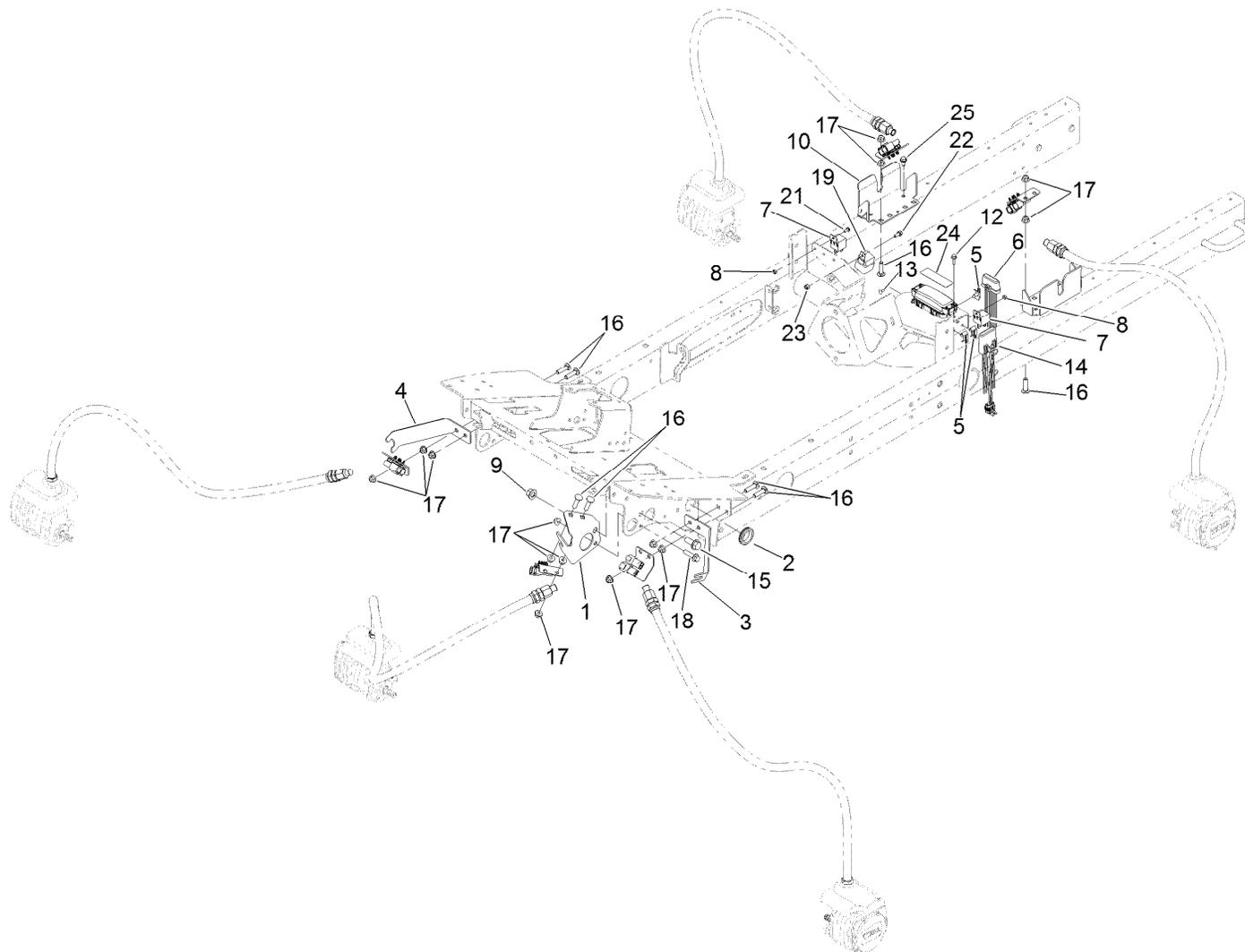

Reel Motor Plumbing Assembly

<i>Ref.</i>	<i>Part Number</i>	<i>Qty.</i>	<i>Description</i>	<i>Ref.</i>	<i>Part Number</i>	<i>Qty.</i>	<i>Description</i>
1	125-1460-01	1	Bracket-Bulkhead, Center	14	119-4330	1	Isolated Can Module ASM
2	240-3	2	Grommet-Rubber	15	3234-38	1	Screw-HHF
3	127-2314-01	1	Bracket-Bulkhead	16	127-2351	10	Screw-CARR
4	127-2317-01	1	Bracket-Bulkhead	17	104-8301	16	Nut-HF, NI
5	32180-011	3	Clip-Connector	18	114-4681	1	Screw-HHF
6	112-9630	1	Module-Reel, I.D.	19	99-7430	1	Relay-Mini
7	99-7435	3	Relay	21	3290-321	2	Screw-HWH
8	3296-2	3	Nut-Lock, NI	22	3234-33	1	Screw-HHF
9	99-5107	1	Nut-Lock	23	3296-42	1	Nut-Lock, NI
10	125-1458-03	2	Bracket-Bulkhead, Rear	24	127-2470	1	Decal-Fuses, Cu
12	33103-020	2	Screw-HHF	25	32104-32	4	Screw-HWH
13	104-1450	1	Bolt-CARR				

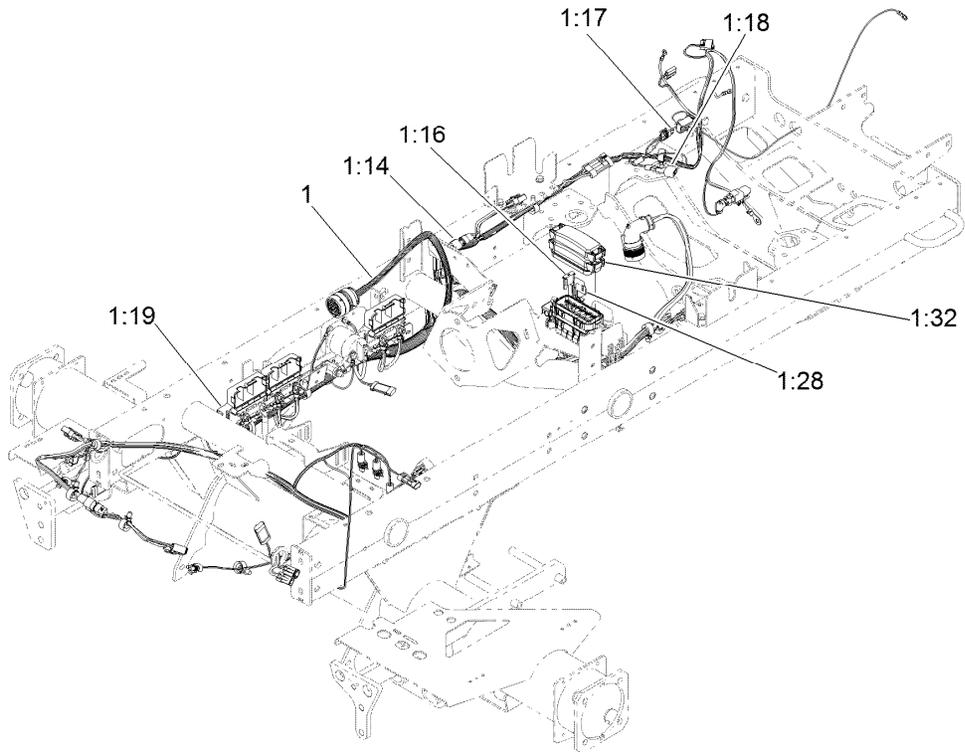

Main Wire Harness Assembly

<i>Ref.</i>	<i>Part Number</i>	<i>Qty.</i>	<i>Description</i>
1	122-0213	1	Harness-Wire, Platform
1:14	32180-043	3	Resistor-120 Ohm
1:16	122-0255	5	Fuse-Maxi, 35 Amp-58V
1:17	121-8861	1	Fuse-Mini Blade, 2 Amp
1:18	100-4918	1	Diode
1:19	119-7781	1	Diode-Sealed
1:28	122-0409	1	Fuse-Mini Blade, 10 Amp
1:32	32180-146	1	Cover-Fuse

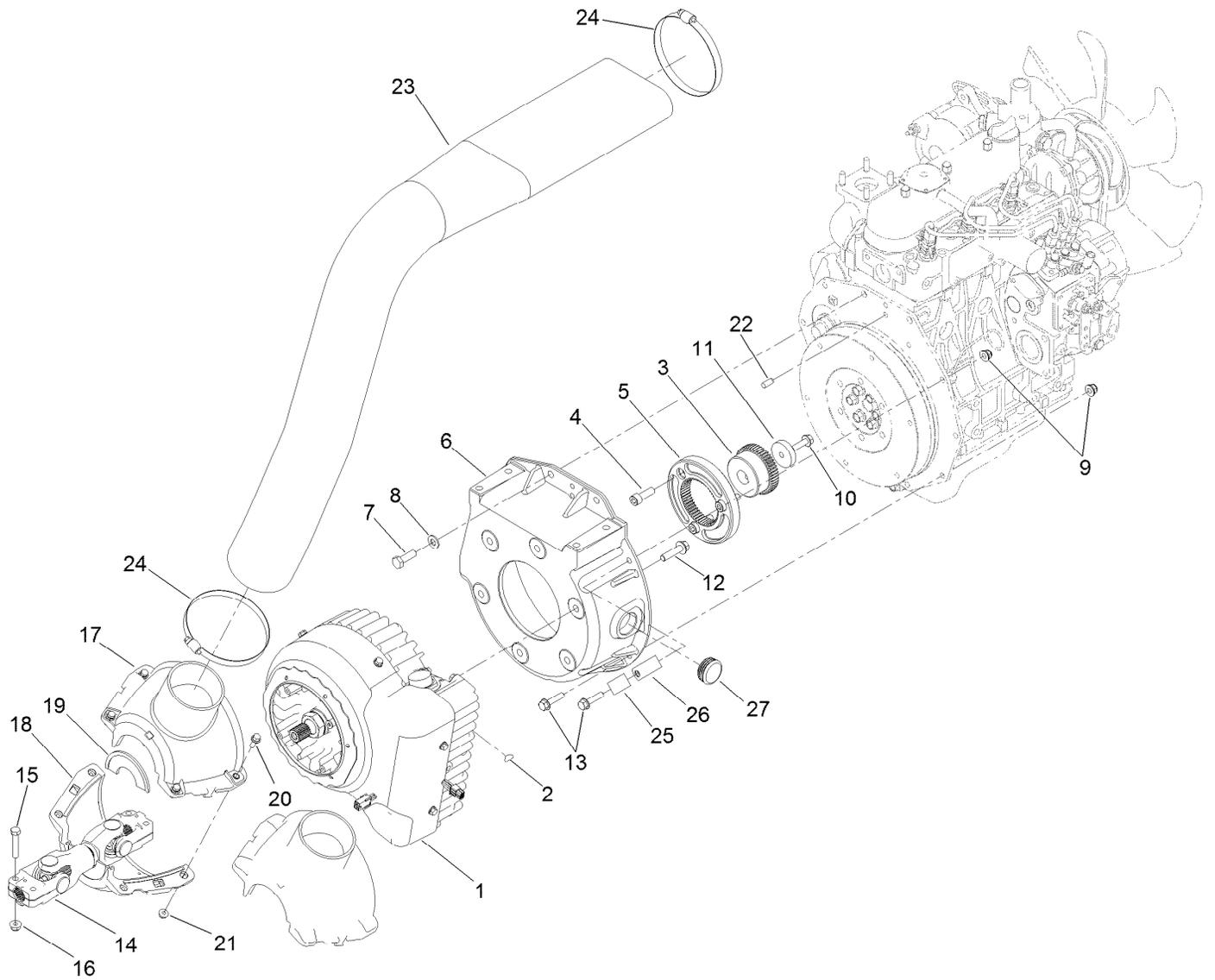

Generator Assembly

<i>Ref.</i>	<i>Part Number</i>	<i>Qty.</i>	<i>Description</i>	<i>Ref.</i>	<i>Part Number</i>	<i>Qty.</i>	<i>Description</i>
1	127-2655	1	Generator/Controller ASM	15	322-9	4	Screw-HH
2	127-2318	1	Key-Woodruff	16	104-8300	4	Nut-HF, NI
3	127-2635	1	Hub-Coupler	17	127-2465	1	Shroud ASM
4	108-1420	3	Screw-HSH	18	127-2442	1	Shroud-Intake, Bottom
5	125-1179	1	Flange-Coupler	19	127-2434	2	Seal-Brush
6	127-2380	1	Bellhousing	20	120-9678	4	Screw-HHF
7	95-8812	2	Screw-HH	21	104-7201	4	Nut-HF, NI
8	3256-80	2	Washer-Plain	22	87-1910	2	Pin-Dowel
9	104-3082	2	Nut-Lock, HHF	23	127-2472	1	Hose-Formed
10	AU100874	1	Screw-HHF	24	2412-46	2	Clamp
11	127-2374	1	Collar	25	2412-39	1	Clamp-R
12	114-4681	6	Screw-HHF	26	2412-41	1	Clamp-R
13	33104-035	7	Screw-HHF	27	110-9012	1	Caplug
14	125-1191	1	Driveshaft ASM				

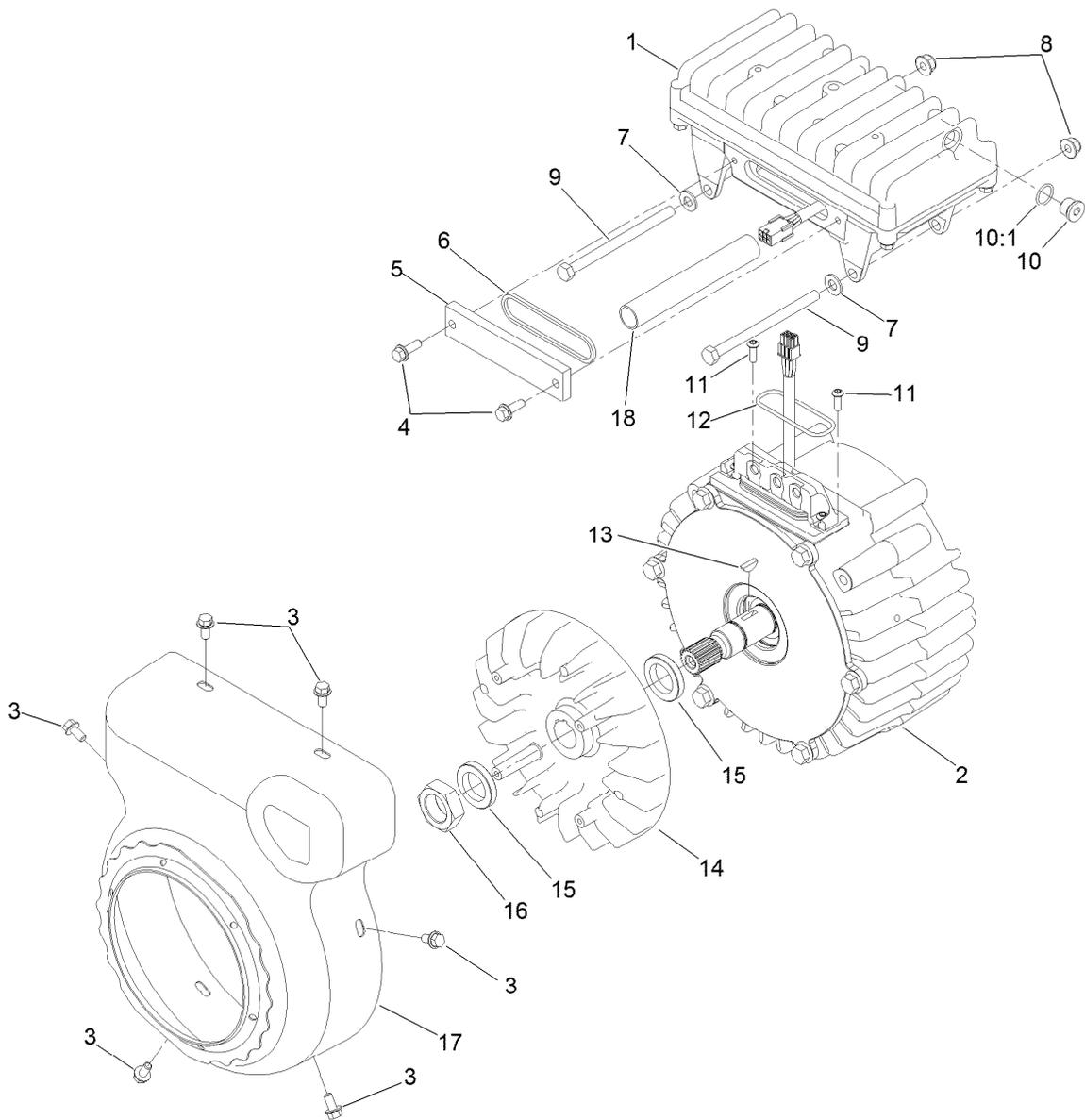

Generator/Controller Assembly No. 127-2655

<i>Ref.</i>	<i>Part Number</i>	<i>Qty.</i>	<i>Description</i>
1	117-8181	1	Controller ASM
2	127-2653	1	Generator Service ASM
3	119-1065	6	Screw-HWH
4	119-1138	2	Screw-HHF
5	120-4511	1	Cover-Access
6	120-4513	1	Gasket-Cover, Access
7	3256-23	2	Washer-Plain
8	104-8300	2	Nut-HF, NI
9	322-38	2	Screw-HH
10	353-989	1	Plug-Hex, Hollow

<i>Ref.</i>	<i>Part Number</i>	<i>Qty.</i>	<i>Description</i>
10:1	237-42	1	O-Ring
11	119-7568	2	Screw-HSBH
12	117-8176	1	O-Ring
13	127-2318	1	Key-Woodruff
14	125-1188	1	Fan-Generator
15	125-1185	2	Spacer
16	125-1187	1	Nut
17	127-2444	1	Cover-Generator
18	127-2747	1	Sleeve-Harness, Expandable

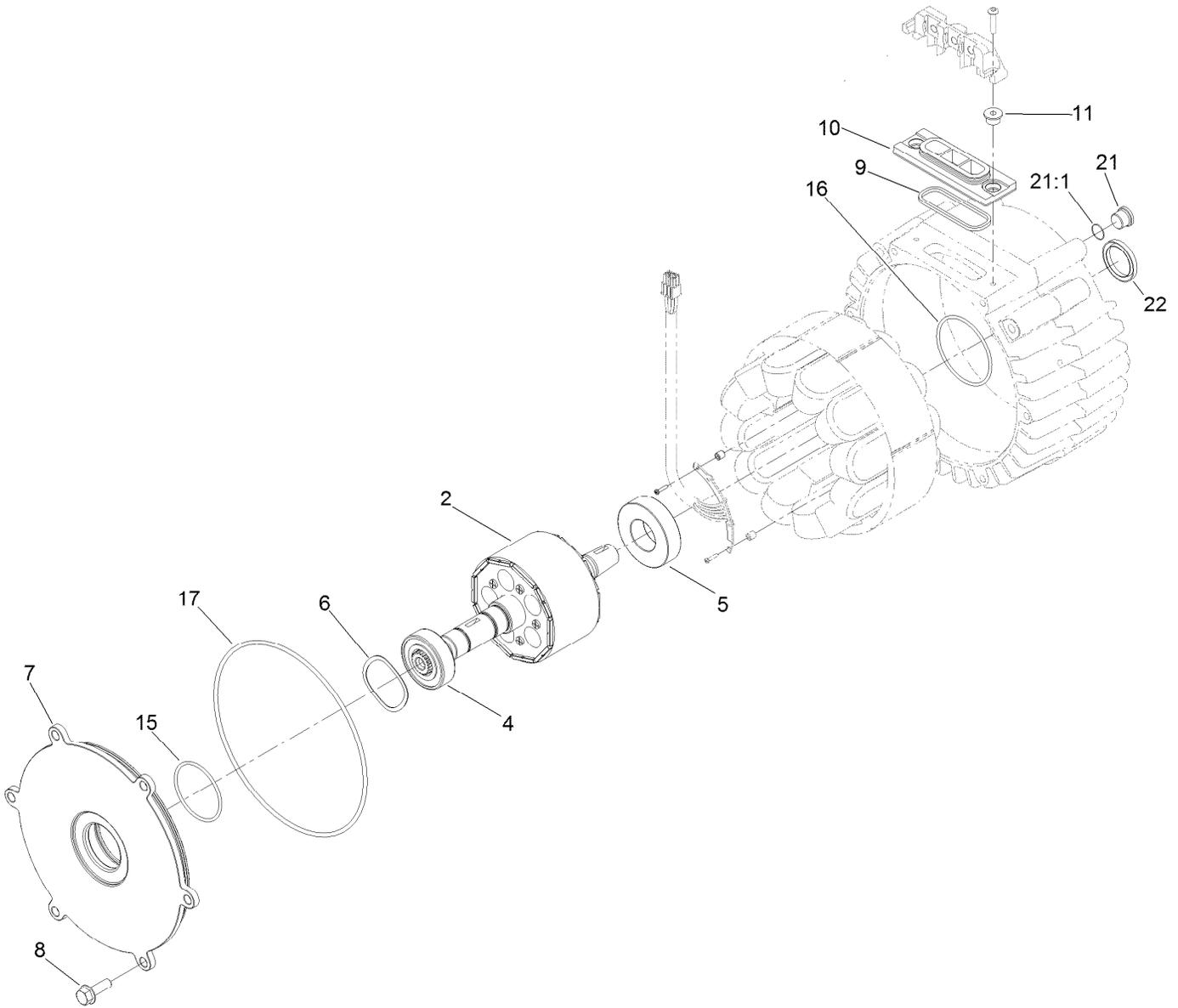

Generator Assembly No. 127-2653

<i>Ref.</i>	<i>Part Number</i>	<i>Qty.</i>	<i>Description</i>
2	127-2651	1	Rotor
4	120-4621	1	Bearing
5	120-4622	1	Bearing
6	117-8148	1	Washer-Wave
7	117-4514	1	Cover-Generator
8	33104-025	6	Screw-HHF
9	120-4518	1	Gasket-Isolator
10	112-5155	1	Isolator-Thermal
11	117-4501	2	Spacer-Shoulder
15	107-3244	1	O-Ring
16	117-8177	1	O-Ring
17	112-5199	1	O-Ring
21	353-989	1	Plug-Hex, Hollow
21:1	237-42	1	O-Ring
22	125-1509	1	Seal

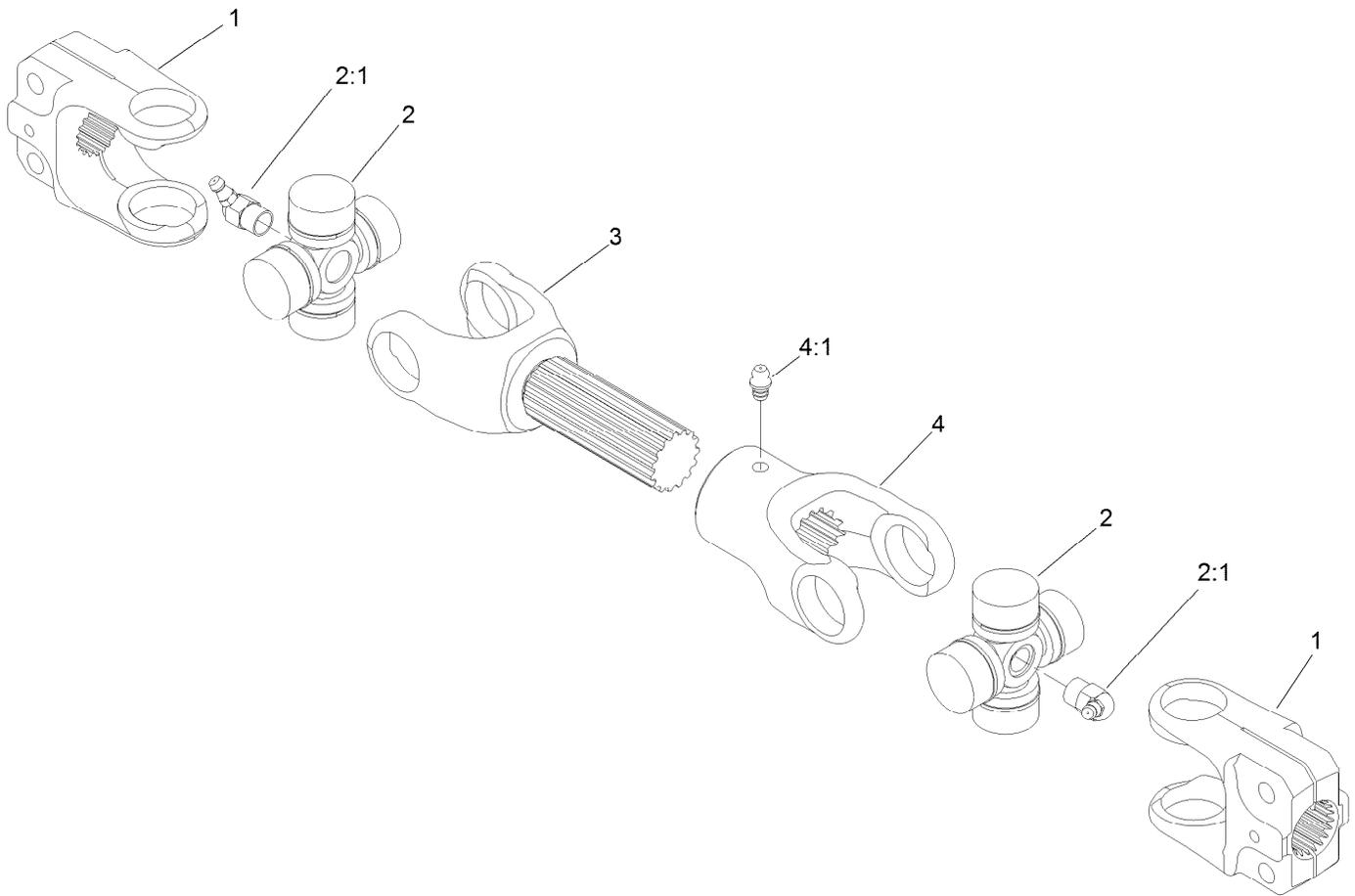

Drive Shaft Assembly No. 125-1191

<i>Ref.</i>	<i>Part Number</i>	<i>Qty.</i>	<i>Description</i>
1	54-9040	2	Yoke-End
2	112-1687	2	Cross And Bearing Kit
2:1	62-3820	1	Fitting-Grease
3	127-2553	1	Yoke-Shaft
4	127-2554	1	Yoke-Telescoping
4:1	302-22	1	Fitting-Grease

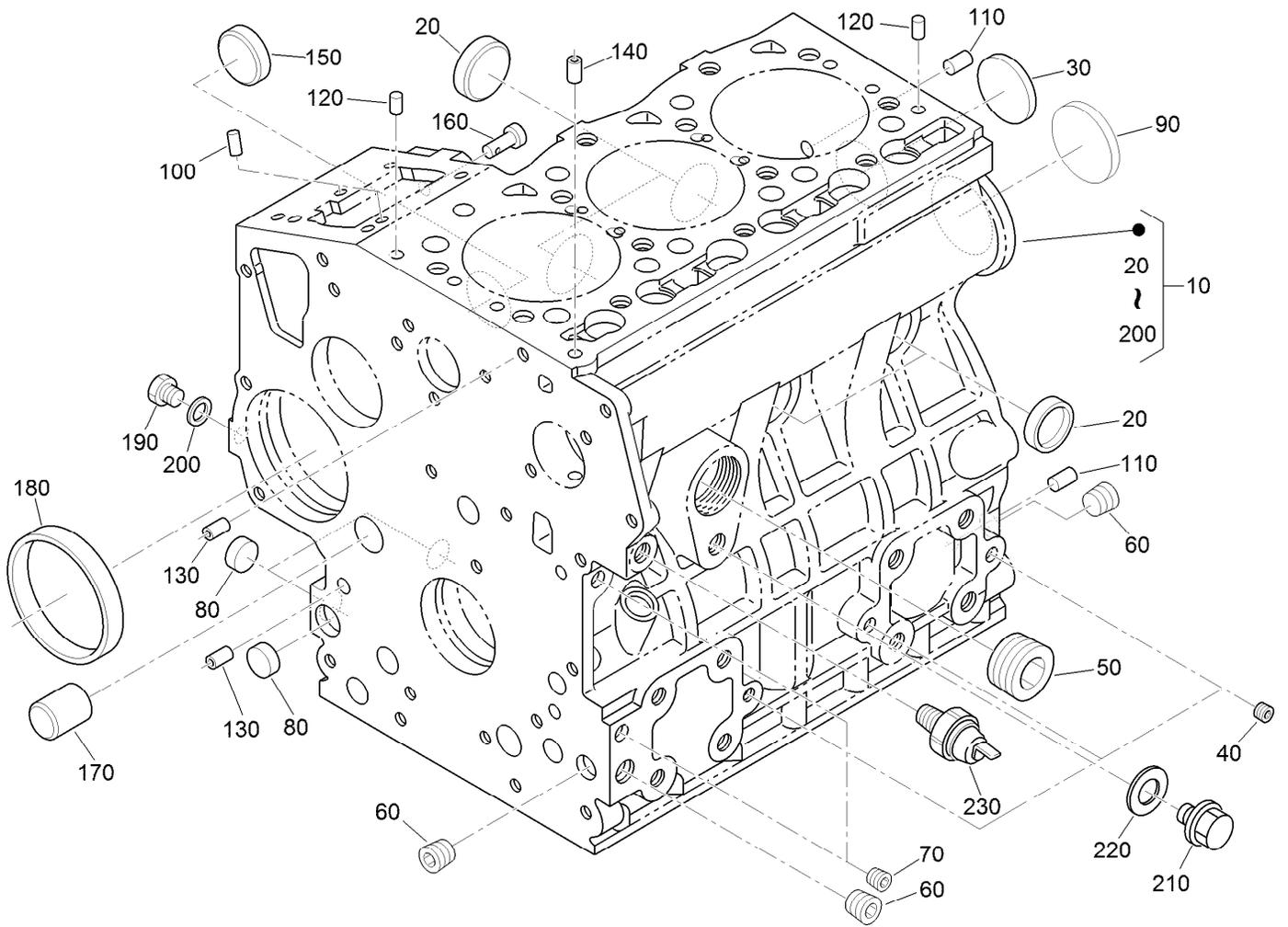

Crankcase Assembly

<i>Ref.</i>	<i>Part Number</i>	<i>Qty.</i>	<i>Description</i>	<i>Ref.</i>	<i>Part Number</i>	<i>Qty.</i>	<i>Description</i>
10	115-3443	1	Crankcase ASM	130	98-9387	2	Pin-Pipe
20	98-9398	4	Cap-Sealing	140	98-9539	1	Pin-Pipe
30	98-7539	1	Cap-Sealing	150	98-9599	1	Plug
40	98-9687	3	Plug	160	98-9630	1	Pin-Spring, Start
50	105-3779	1	Plug	170	98-9675	1	Plug
60	98-9597	3	Plug	180	98-9656	1	Bushing-Governor, Gear
70	98-7487	2	Plug	190	120-2559	1	Plug
80	98-9379	3	Plug-Expansion	200	98-7428	1	Gasket
90	98-9668	1	Plug-Expansion	210	99-3447	1	Plug
100	98-9375	2	Pin-Straight	220	106-7056	1	Gasket
110	98-9377	2	Pin-Straight	230	98-9416	1	Switch-Oil
120	98-9376	2	Pin-Straight				

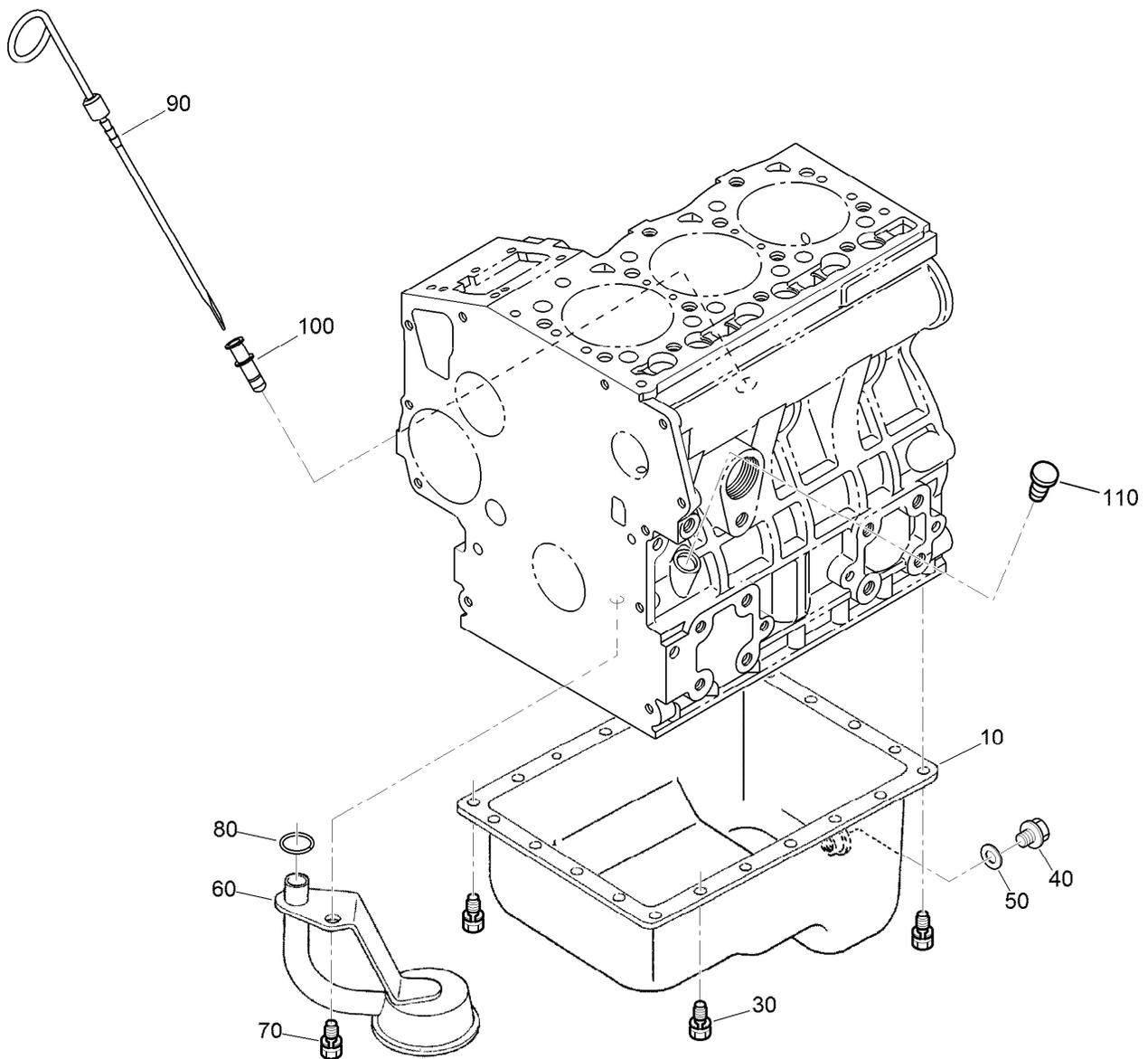

Oil Pan and Dipstick Assembly

<i>Ref.</i>	<i>Part Number</i>	<i>Qty.</i>	<i>Description</i>
10	112-0179	1	Pan-Oil
30	98-9351	22	Bolt
40	114-8151	1	Plug-Drain
50	98-7524	1	Gasket
60	108-1401	1	Base-Filter
70	98-7526	1	Bolt
80	105-3776	1	O-Ring
90	104-9348	1	Gauge-Oil
100	105-4580	1	Guide-Gauge, Oil
110	110-3720	1	Plug-Gauge, Oil

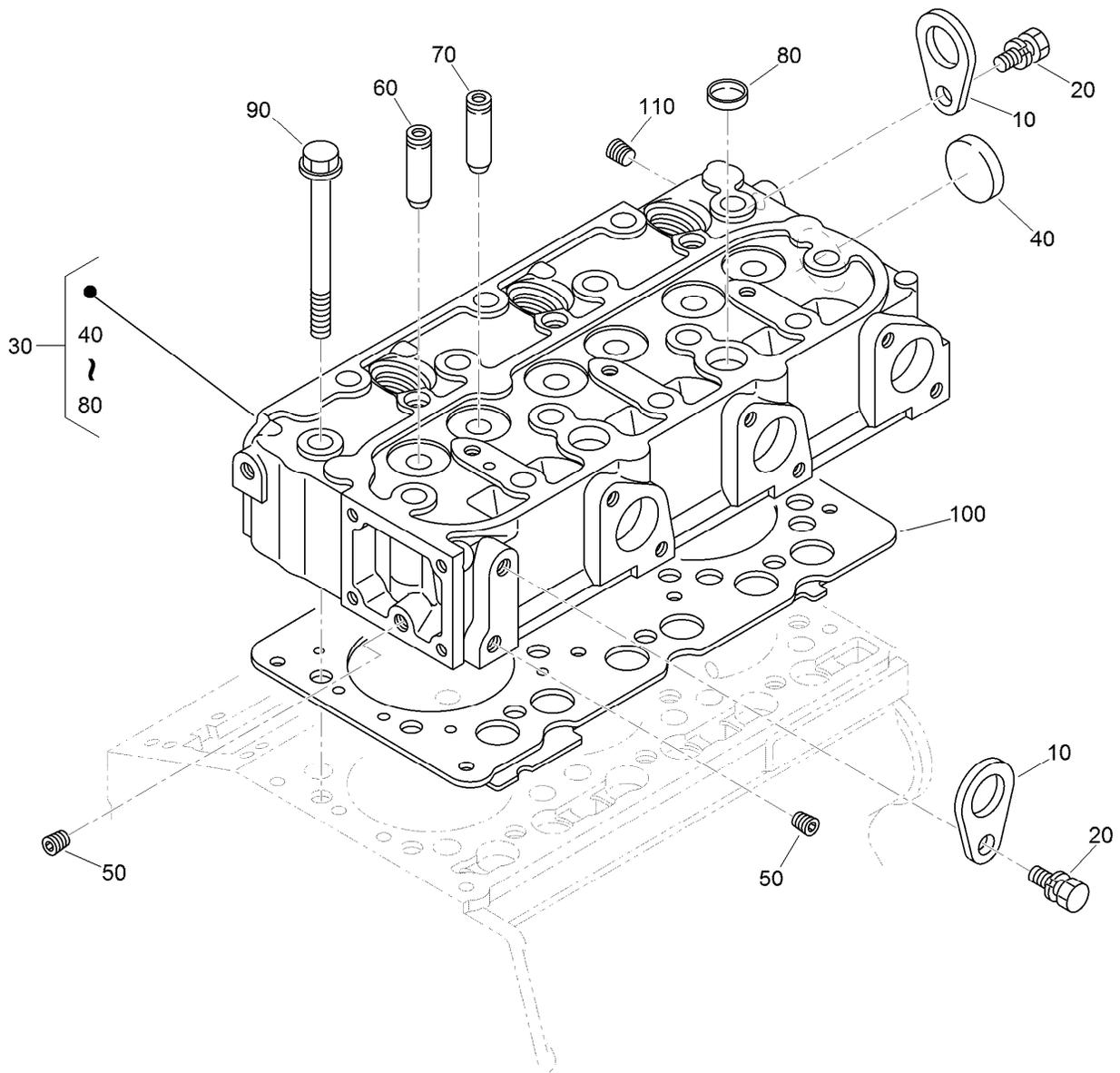

Cylinder Head Assembly

Ref.	Part Number	Qty.	Description
10	98-7531	2	Hook-Engine
20	100-9195	2	Bolt
30	130-1544	1	Cylinder Head ASM
40	105-3705	1	Cap-Sealing
50	98-9687	2	Plug
60	107-9066	3	Guide-Valve, Inlet
70	107-9067	3	Guide-Valve, Exhaust
80	98-9389	2	Cap-Sealing
90	98-9479	14	Bolt-Head, Cylinder
100	108-6573	1	Gasket-Head, Cylinder
110	98-9444	1	Plug

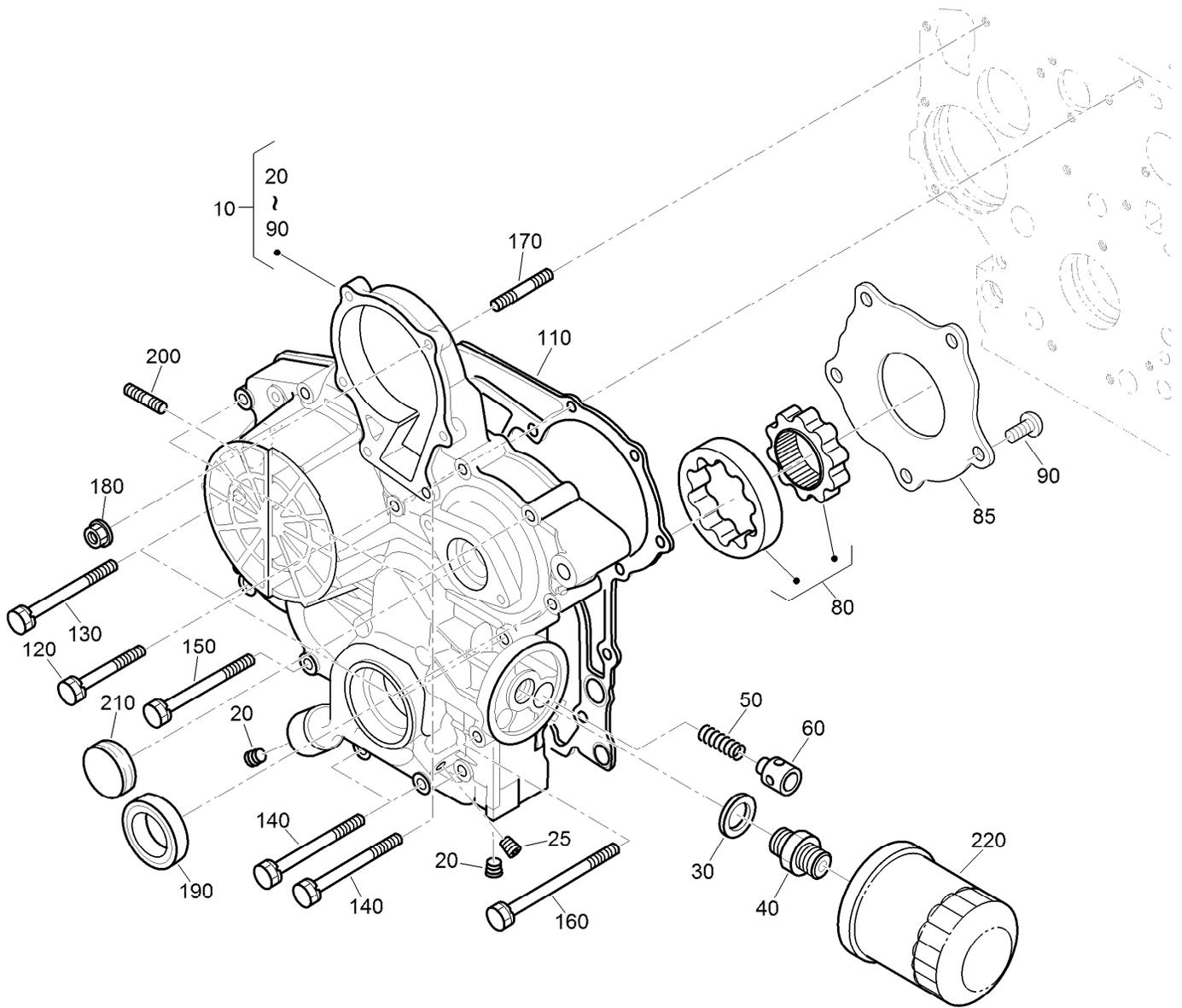

Gear Case and Oil Filter Cartridge Assembly

Ref.	Part Number	Qty.	Description	Ref.	Part Number	Qty.	Description
10	115-4105	1	Gear Case ASM	120	100-1765	3	Bolt
20	127-0425	2	Plug	130	125-9063	4	Bolt-Sems
25	98-7487	1	Plug	140	98-9356	4	Bolt
30	98-7562	1	Washer-Plain	150	107-9074	1	Bolt
40	98-9388	1	Joint-Pipe	160	98-9586	1	Bolt
50	130-1511	1	Spring	170	105-3709	1	Stud
60	130-1510	1	Valve-Relief	180	100-2203	1	Nut-Flange
80	130-1508	1	Rotor ASM	190	119-8038	1	Seal-Oil
85	130-1509	1	Cover-Pump, Oil	200	105-3710	2	Stud
90	130-1164	5	Screw-Binding	210	99-3515	1	Plug-Gearcase
110	98-9633	1	Gasket-Case, Gear	220	127-0511	1	Filter-Oil

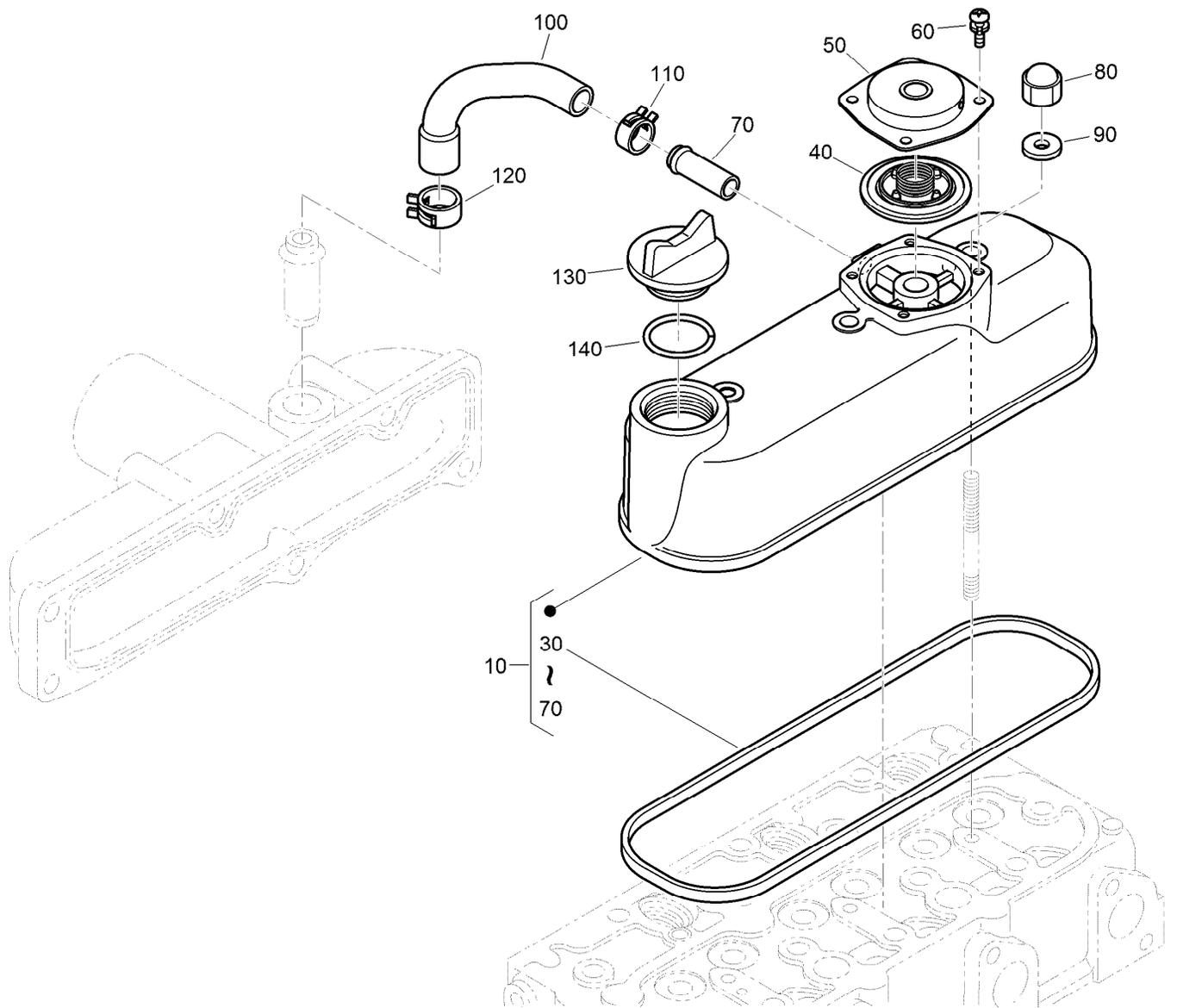

Cylinder Head Cover Assembly

<i>Ref.</i>	<i>Part Number</i>	<i>Qty.</i>	<i>Description</i>
10	130-1372	1	Cylinder Head Cover ASM
30	98-9615	1	Gasket-Cover, Head
40	110-3715	1	Valve-Breather
50	110-3714	1	Cover-Breather
60	98-9364	4	Screw (With Washer)
70	98-7766	1	Pipe-Return, Water
80	98-9455	3	Nut-Cap
90	98-9454	3	Gasket
100	108-2858	1	Tube-Breather
110	108-2859	1	Clamp-Hose
120	108-2860	1	Clamp-Hose
130	107-9075	1	Plug-Filler, Oil
140	99-3446	1	O-Ring

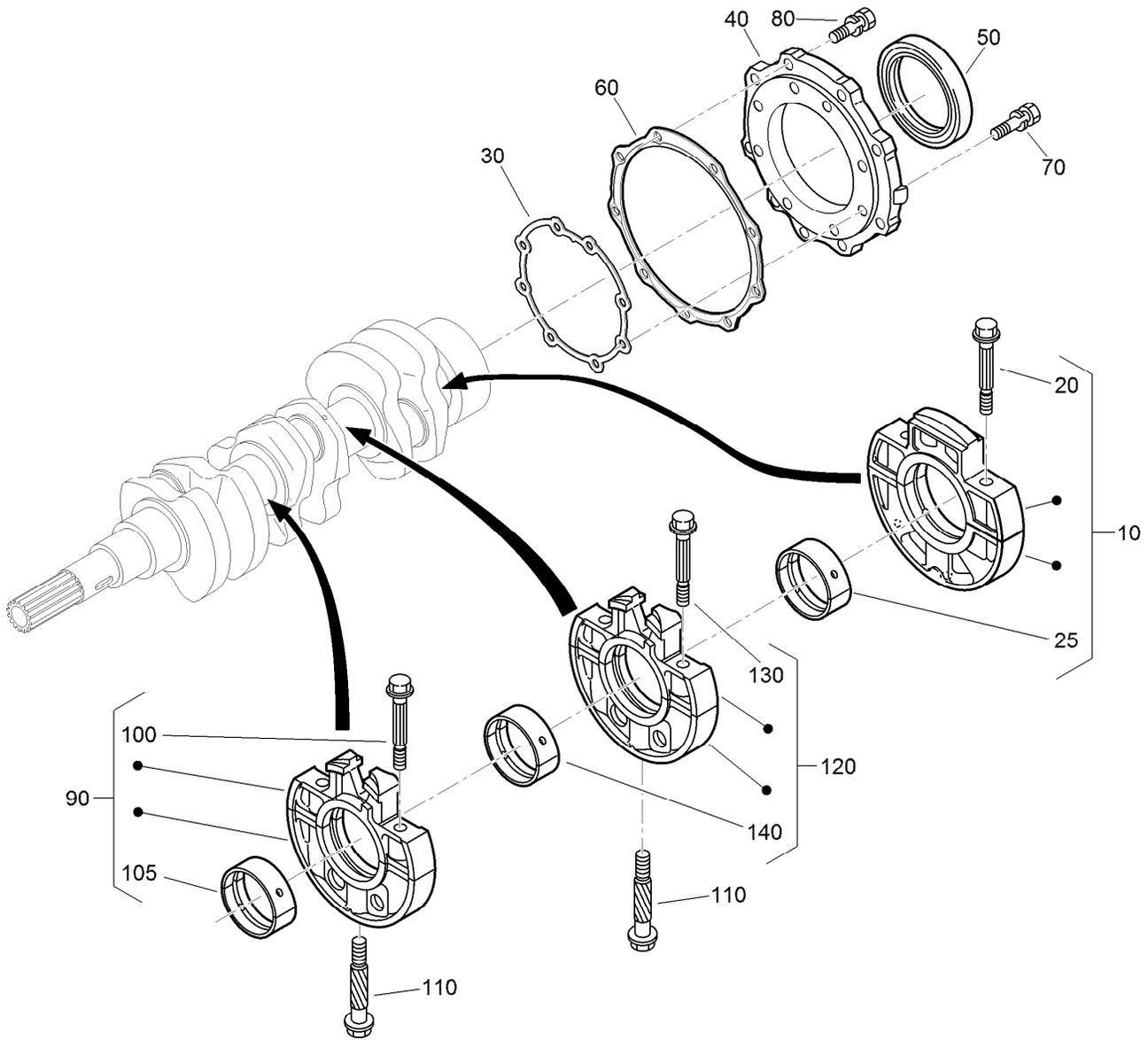

Main Bearing Case Assembly

Ref.	Part Number	Qty.	Description
10	112-7026	1	Wheel Bearing Case ASM
20	98-9484	2	Bolt-Case, Bearing
25	115-4121	1	Metal-Crankshaft (STD)
25	112-7039	1	Metal-Crankshaft (0.2Mm)
25	112-7040	1	Metal-Crankshaft (-0.4Mm)
30	131-6554	1	Gasket-Case, Bearing
40	112-7046	1	Cover-Case, Bearing
50	112-0180	1	Seal-Oil
60	112-7037	1	Gasket-Cover, Case
70	127-0441	8	Bolt
80	127-0442	9	Bolt

Ref.	Part Number	Qty.	Description
90	115-4106	1	Main Bearing Case ASM
100	98-9484	2	Bolt-Case, Bearing
105	98-9524	1	Metal-Crankshaft (STD Set)
105	127-0433	1	Metal-Crankshaft (-0.2MM)
110	98-9531	1	Bearing-Main (0.4MM)
110	98-9485	2	Bolt-Case, Bearing
120	115-4107	1	Main Bearing Case ASM
130	98-9484	2	Bolt-Case, Bearing
140	98-9524	1	Metal-Crankshaft (STD Set)
140	127-0433	1	Metal-Crankshaft (-0.2MM)
140	98-9531	1	Bearing-Main (0.4MM)

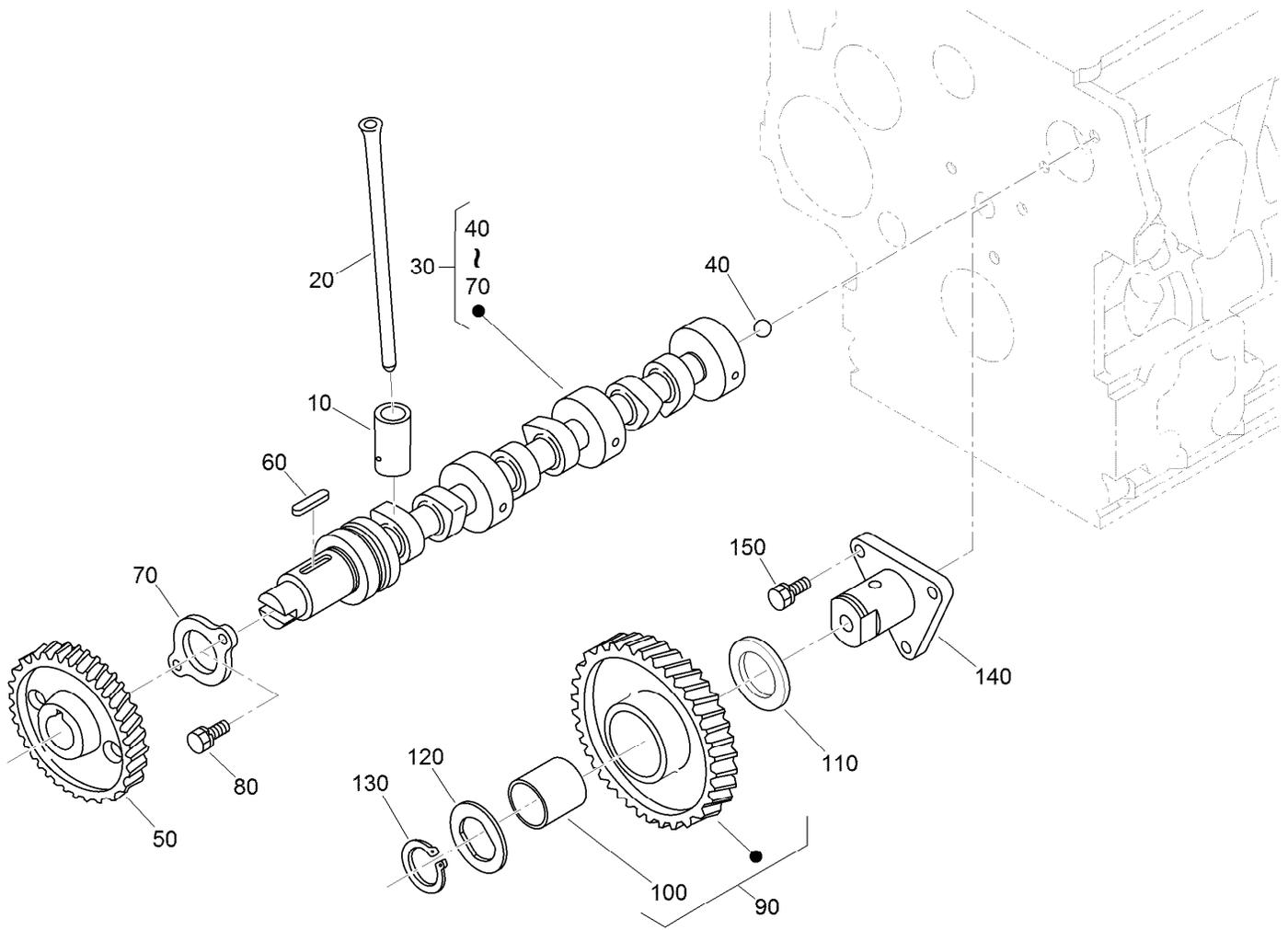

Camshaft and Idle Gear Shaft Assembly

Ref.	Part Number	Qty.	Description
10	112-0185	6	Tappet
20	127-0421	6	Rod-Push
30	130-1545	1	Camshaft ASM
40	110-3729	1	Ball
50	98-9512	1	Gear-Cam
60	98-9378	1	Key-Feather
70	131-6555	1	Stopper (Camshaft)
80	98-7692	2	Bolt
90	117-7584	1	Idler Gear ASM
100	117-7585	1	Bushing-Gear, Idle
110	98-9535	1	Collar-Gear, Idle
120	98-9536	1	Collar-Gear, Idle
130	98-9534	1	Circlip-Gear, Idle
140	98-9533	1	Shaft-Gear, Idle
150	98-7692	3	Bolt

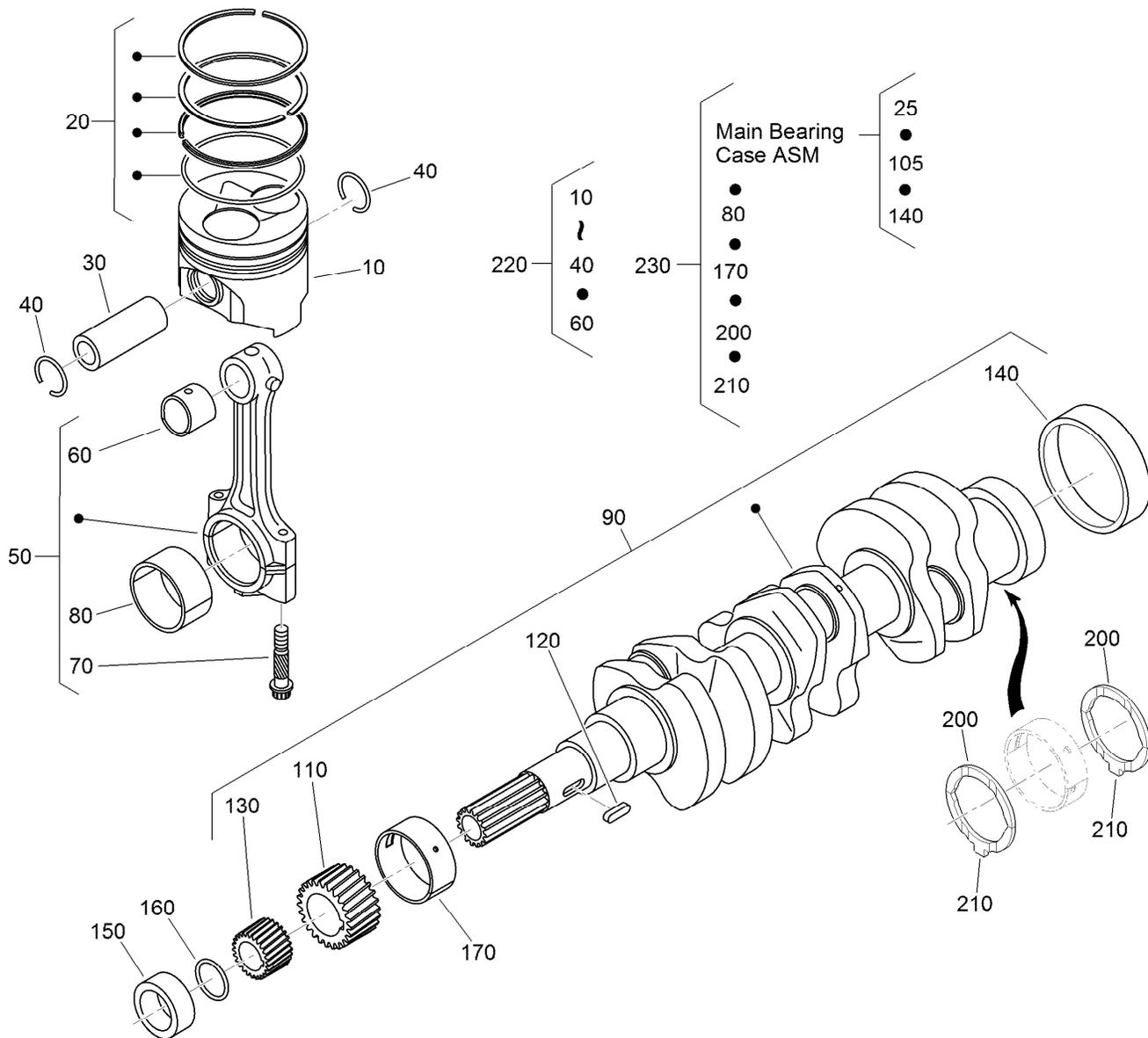

Piston and Crankshaft Assembly

Ref.	Part Number	Qty.	Description
10	130-1546	3	Piston (STD)
10	130-1549	3	Piston (+0.50MM)
20	130-1506	3	Piston Ring ASM (STD)
20	130-1507	3	Piston Ring ASM (+0.50MM)
30	98-9513	3	Pin-Piston
40	98-9514	6	Circlip-Pin, Piston
50	117-7586	3	Connecting Rod ASM
60	115-3014	3	Bushing-Pin, Piston
70	98-9517	6	Bolt-Rod, Connecting
80	98-9553	3	Bearing-Rod (STD)
80	98-9519	3	Bearing-Rod (-0.2MM)
80	117-7588	3	Metal-Crankpin (-0.4MM)
90	130-1375	1	Crankshaft ASM
110	117-7561	1	Gear-Crankshaft
120	98-9666	1	Key
130	127-0445	1	Gear-Drive, Oil Pump
140	98-9522	1	Sleeve-Crankshaft
150	127-0444	1	Collar-Crankshaft

Ref.	Part Number	Qty.	Description
160	105-3783	1	O-Ring
170	112-7005	1	Bearing-Main (STD)
170	98-9528	1	Bearing-Main (-0.2MM)
170	130-1274	1	Metal-Crankshaft (-0.40Mm)
200	98-9413	2	Bearing-Thrust (STD)
200	127-0416	2	Metal-Side (+0.2Mm)
200	127-0417	2	Metal-Side (+0.40Mm)
210	98-9688	2	Bearing-Thrust (STD)
210	127-0437	2	Metal-Side (+0.2MM)
210	127-0438	2	Metal-Side (+0.40MM)
220	130-1547	3	Piston Kit
220	130-1548	3	Piston Kit
230	130-1501	1	Engine Metal Kit (STD)
230	130-1498	1	Engine Metal Kit (-0.20Mm/+0.20Mm)
230	130-1499	1	Engine Metal Kit (-0.40Mm/+0.40Mm)

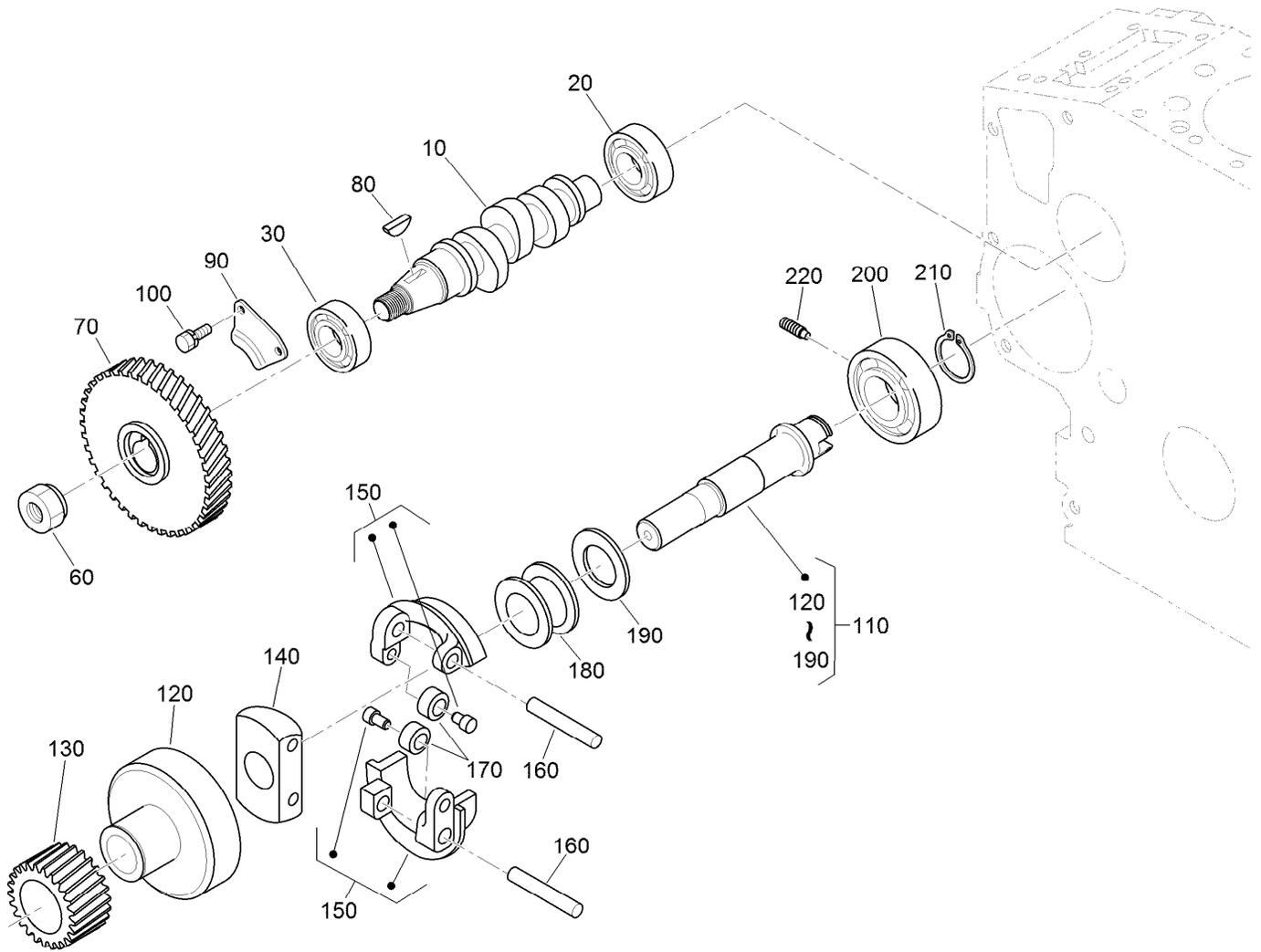

Fuel Camshaft and Governor Shaft Assembly

Ref.	Part Number	Qty.	Description
10	98-9459	1	Camshaft-Fuel
20	107-9077	1	Bearing-Ball
30	107-9078	1	Bearing-Ball
60	130-1512	1	Nut
70	120-2562	1	Gear-Pump, Injection
80	98-9595	1	Key-Woodruff
90	98-9511	1	Stopper-Fuel, Camshaft
100	98-7692	2	Bolt
110	130-1255	1	Governor Shaft ASM
120	98-9562	1	Holder-Gear, Governor

Ref.	Part Number	Qty.	Description
130	98-9673	1	Gear-Governor
140	98-9561	1	Holder-Weight, Governor
150	130-1240	2	Governor Weight ASM
160	98-9560	2	Shaft-Weight, Governor
170	98-9692	2	Roller
180	98-9563	1	Sleeve-Governor
190	98-9564	1	Washer-Thrust
200	107-9079	1	Bearing-Ball
210	98-9657	1	Circlip-Shaft, Governor
220	98-9565	1	Screw-Set

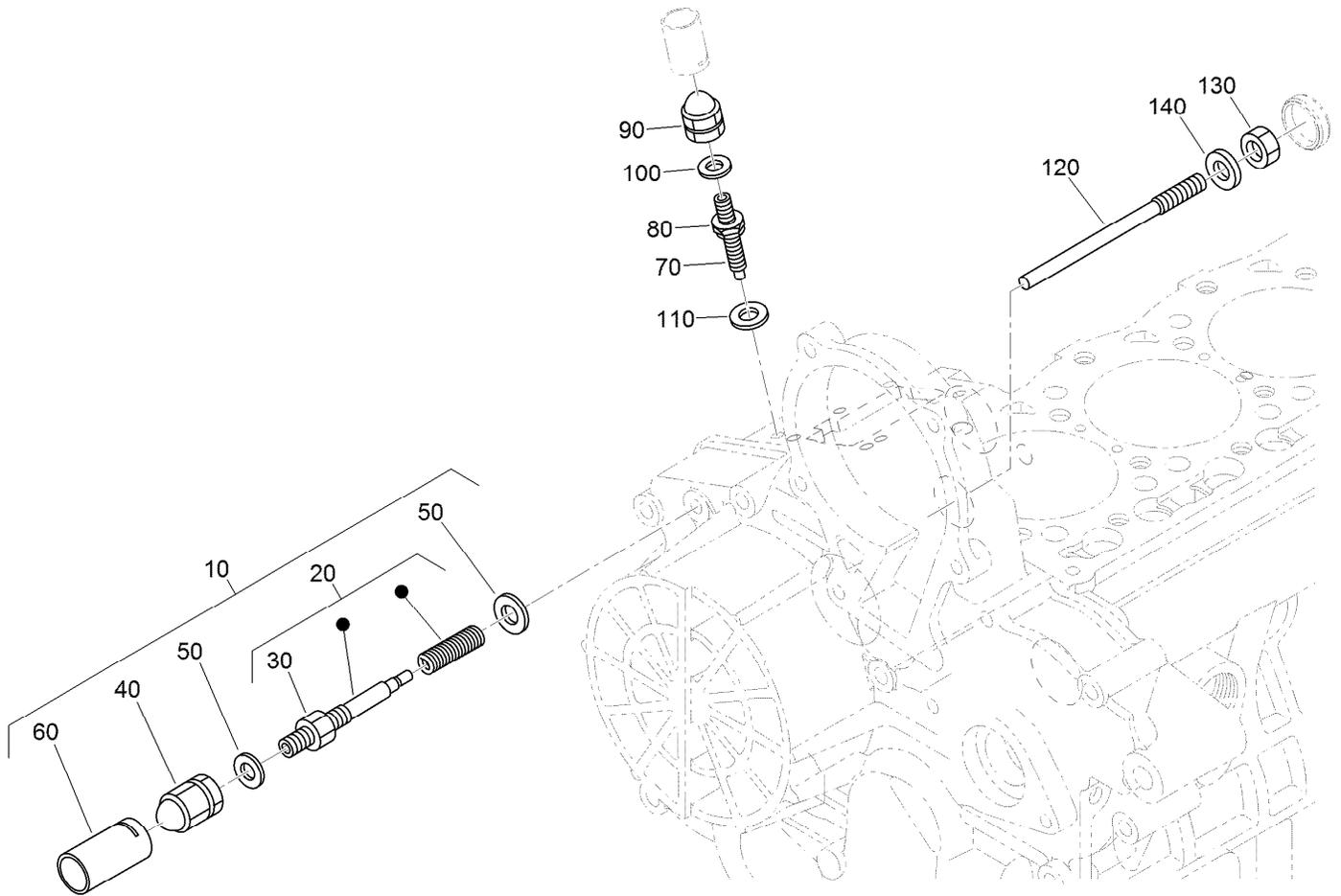

Idle Apparatus Assembly

Ref.	Part Number	Qty.	Description
10	98-9678	1	Idle Apparatus ASM
20	112-7014	1	Adjusting Bolt ASM
30	98-9439	1	Nut
40	112-0181	1	Nut
50	98-7654	2	Gasket
60	98-7656	1	Cap
70	112-7015	1	Bolt-Adjusting
80	100-2175	1	Nut-Lock
90	112-0181	1	Nut
100	98-7654	1	Gasket
110	107-9081	1	Gasket
120	131-6556	1	Bolt
130	98-7572	1	Nut
140	98-7654	1	Gasket

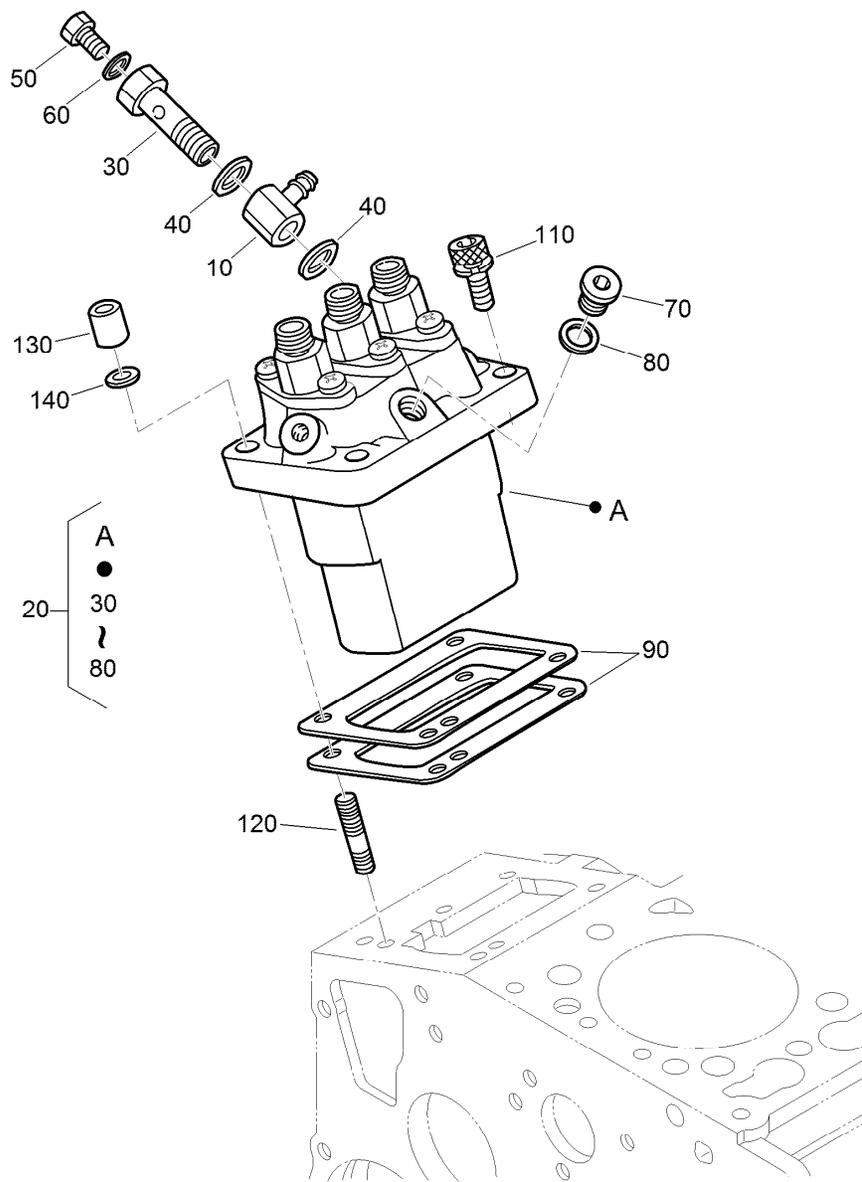

Injection Pump Assembly

Ref.	Part Number	Qty.	Description	Ref.	Part Number	Qty.	Description
10	98-9596	1	Joint-Eye	90	98-9457	1	Shim-Injection (0.25MM)
20	98-9643	1	Injection Pump ASM	90	98-9458	1	Shim-Injection (0.30MM)
30	98-9464	1	Bolt-Joint	90	115-3046	1	Shim-Injection (0.35MM)
40	98-9445	2	Gasket	90	115-3045	1	Shim-Injection (0.175MM)
50	98-9430	1	Screw	110	117-7564	2	Bolt-Hex Soc HD
60	98-9446	1	Gasket	120	98-9438	2	Stud
70	98-9466	1	Plug	130	98-9440	2	Nut-Cap
80	98-9451	1	Gasket	140	98-7699	2	Washer-Spring
90	98-9456	1	Shim-Injection (0.20MM)				

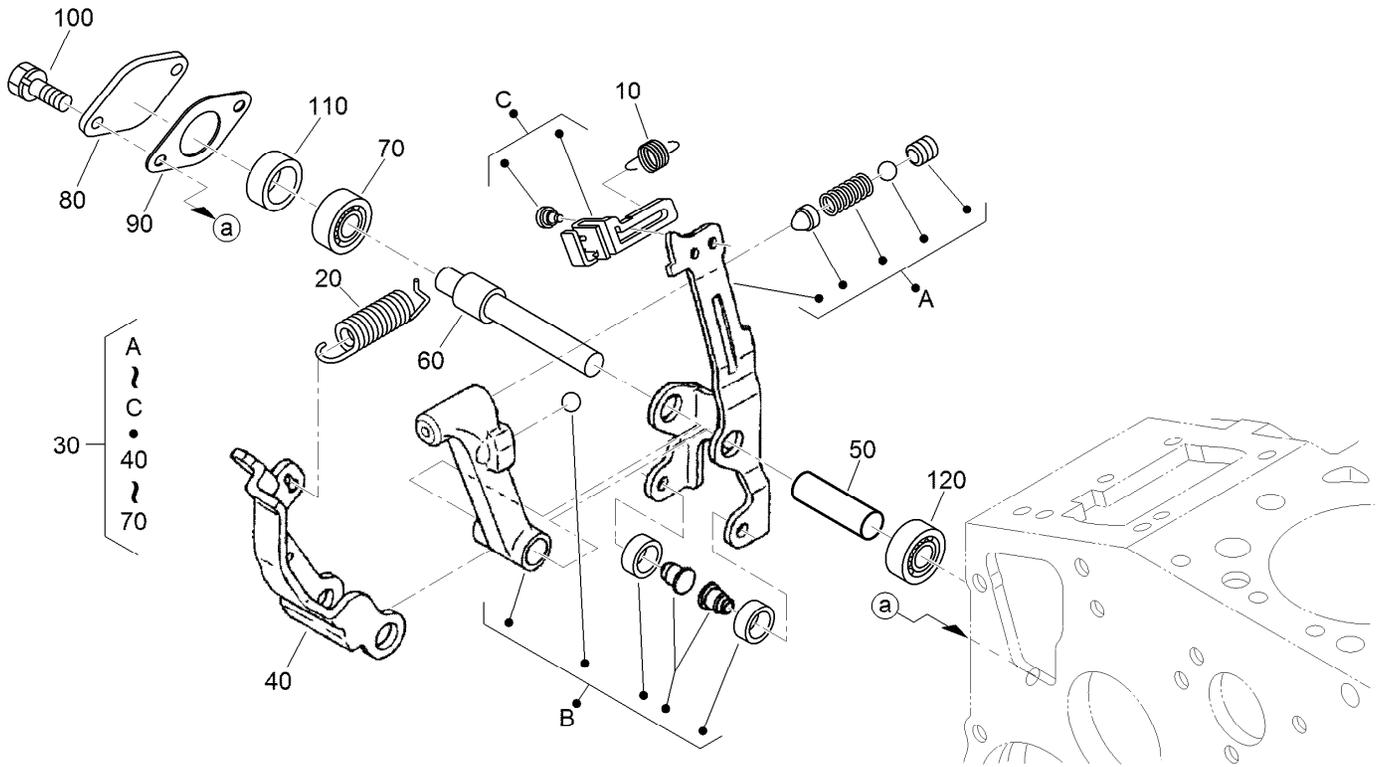

Governor Assembly

Ref.	Part Number	Qty.	Description
10	105-3786	1	Spring-Start
20	98-9681	1	Spring-Governor
30	115-4502	1	Fork Lever ASM
40	107-9084	1	Lever-Fork
50	107-9085	1	Shaft-Lever, Fork
60	107-9086	1	Shaft-Lever, Fork
70	98-9570	1	Bearing-Miniaturize
80	115-4122	1	Cover-Shaft, Fork Lever
90	98-9682	1	Gasket
100	98-9350	2	Bolt
110	98-9567	1	Collar
120	98-9571	1	Bearing-Miniaturize

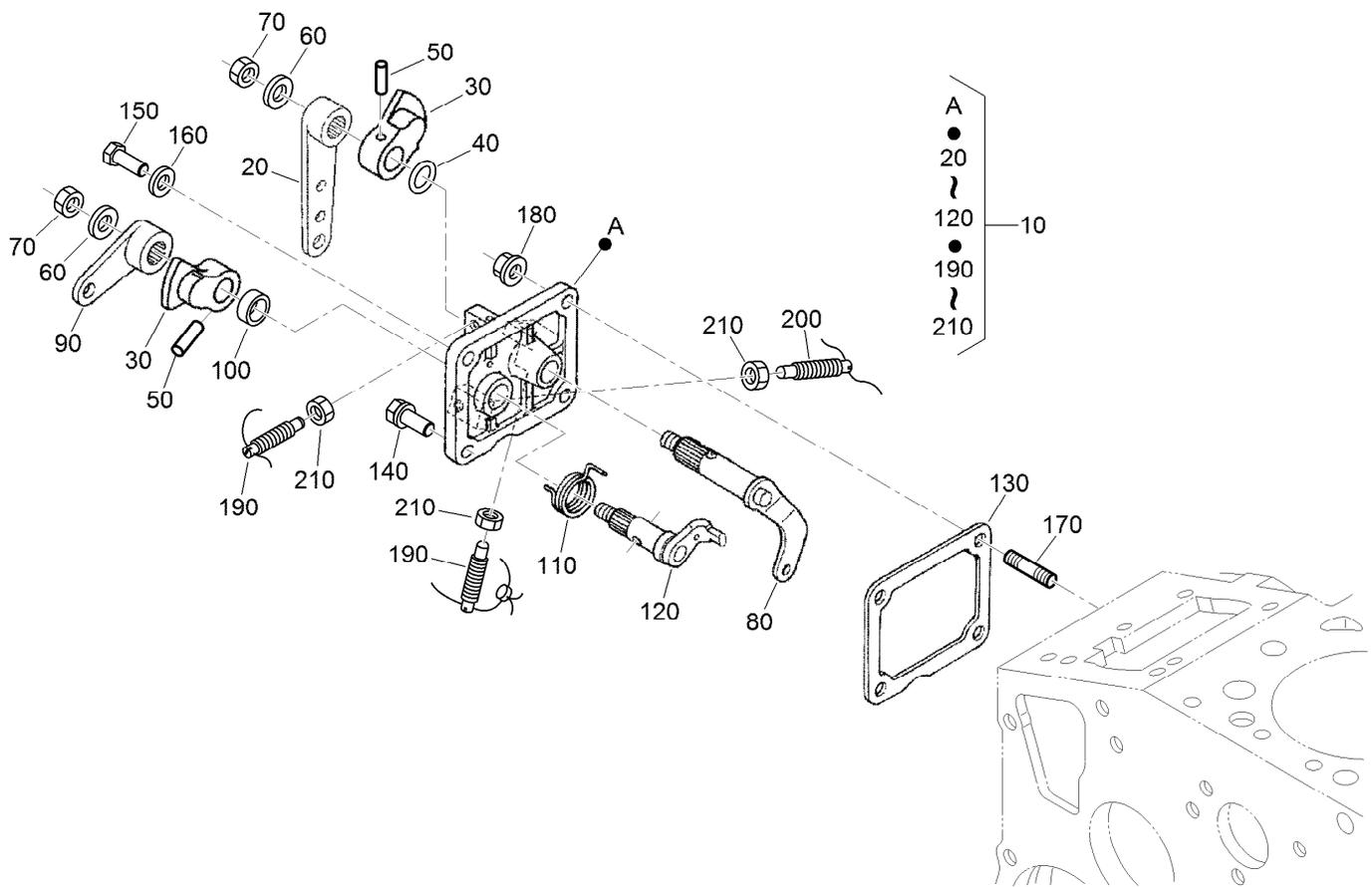

Speed Control Plate Assembly

<i>Ref.</i>	<i>Part Number</i>	<i>Qty.</i>	<i>Description</i>	<i>Ref.</i>	<i>Part Number</i>	<i>Qty.</i>	<i>Description</i>
10	105-3735	1	Control Plate ASM	120	98-9664	1	Shaft-Lever, Stop
20	98-9662	1	Lever-Control, Speed	130	98-9637	1	Gasket
30	98-9572	2	Lever-Control, Speed	140	98-7692	1	Bolt
40	105-3788	1	O-Ring	150	127-0401	1	Bolt-Hex
50	98-7602	2	Pin-Spring	160	98-7654	1	Gasket
60	98-9594	2	Washer-Plain	170	105-3710	2	Stud
70	98-9589	2	Nut	180	100-2203	2	Nut-Flange
80	98-9658	1	Governor Lever ASM	190	117-7565	2	Bolt-Adjusting
90	98-9663	1	Lever-Stop, Engine	200	117-7566	1	Bolt-Adjusting
100	98-7601	1	Seal-Oil	210	98-7572	3	Nut
110	98-9472	1	Spring-Return				

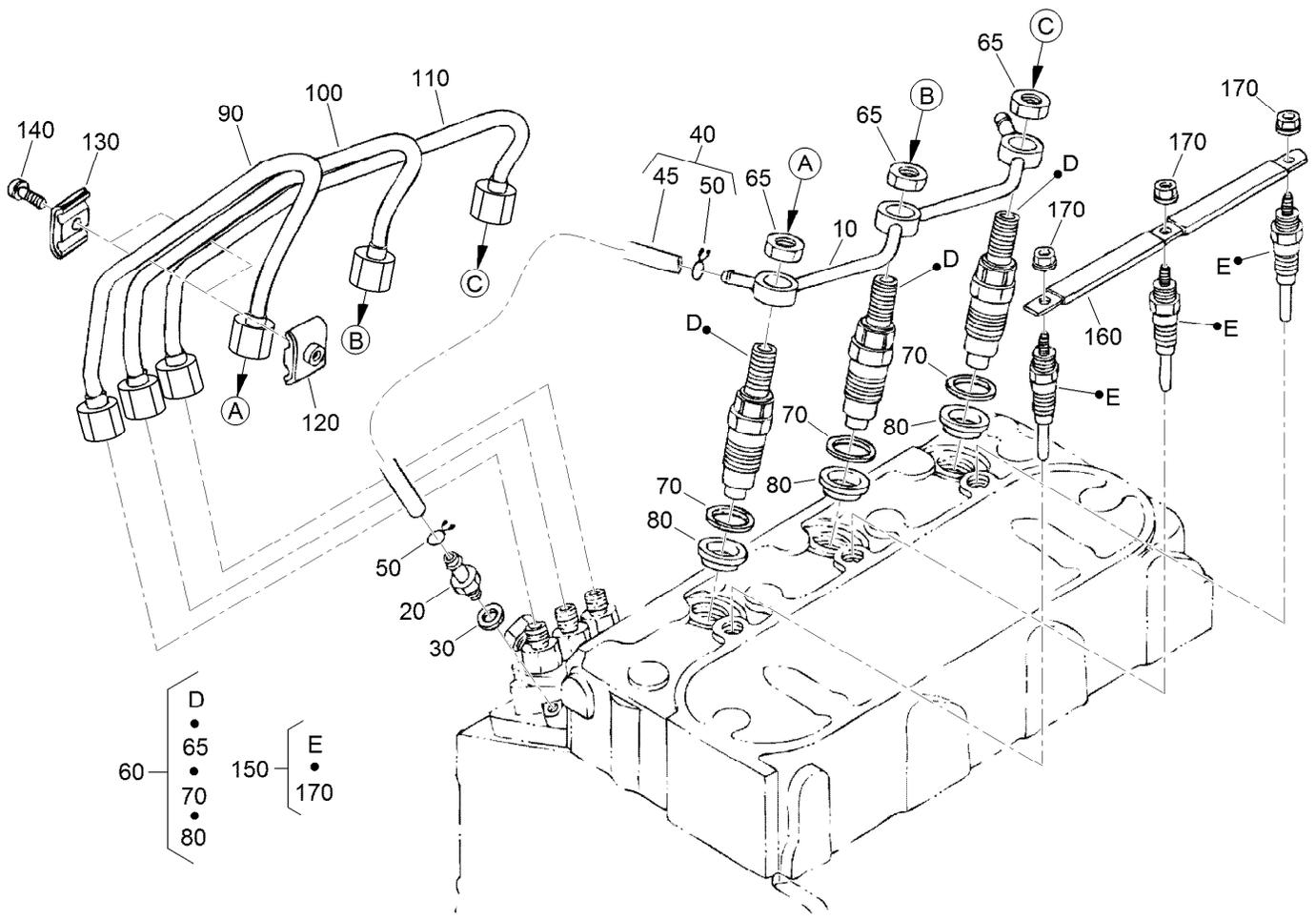

Nozzle Holder and Glow Plug Assembly

<i>Ref.</i>	<i>Part Number</i>	<i>Qty.</i>	<i>Description</i>	<i>Ref.</i>	<i>Part Number</i>	<i>Qty.</i>	<i>Description</i>
10	98-9620	1	Overflow Pipe ASM	90	98-9653	1	Pipe-Injection
20	98-9431	1	Screw-Bleeder, Air	100	98-9654	1	Pipe-Injection
30	98-7654	1	Gasket	110	98-9655	1	Pipe-Injection
40	98-9420	1	Overflow Pipe ASM	120	98-7682	2	Clamp-Pipe
45	112-0182	1	Pipe-Overflow	130	98-7683	2	Clamp-Pipe
50	98-7671	2	Clip-Pipe	140	98-7684	2	Screw (W/Washer)
60	115-3018	3	Nozzle Holder Kit	150	130-1411	3	Plug-Glow
65	121-2411	3	Nut	160	98-9631	1	Cord-Plug, Glow
70	98-7676	3	Gasket	170	99-8377	3	Nut-Flange
80	98-7677	3	Seal-Heat				

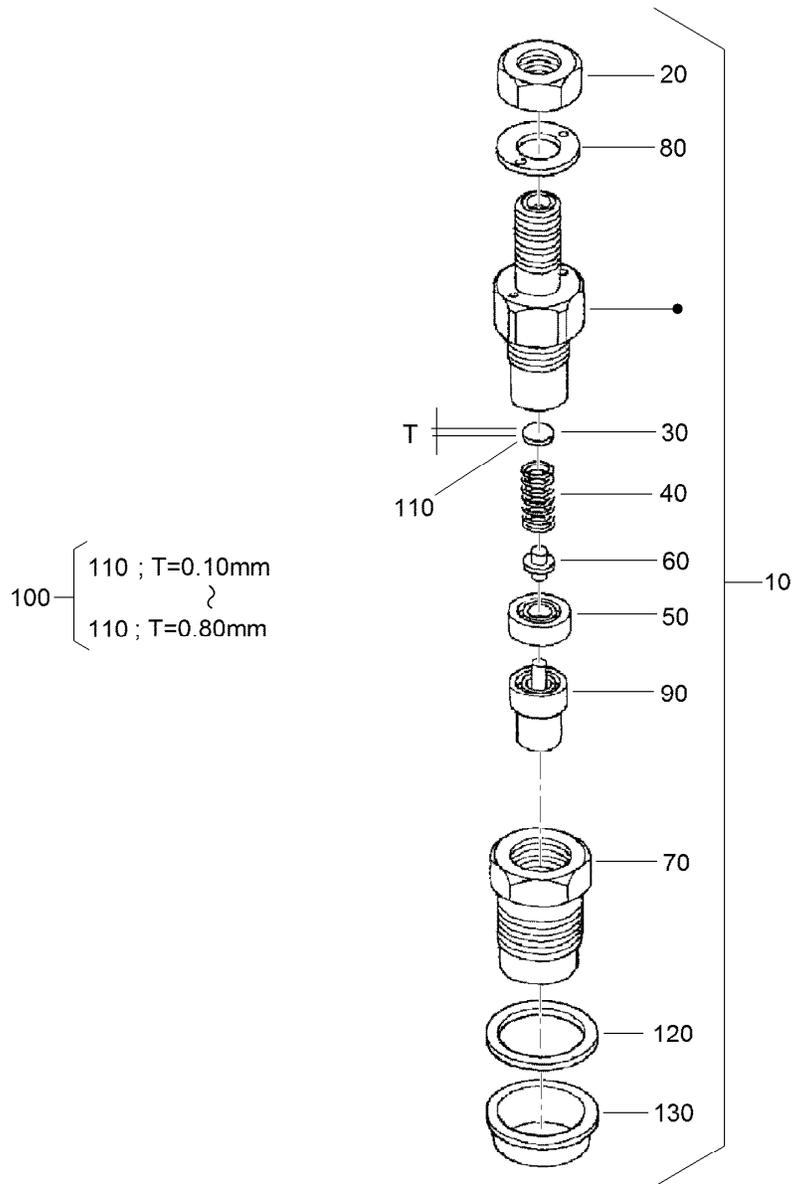

Nozzle Holder Assembly

<i>Ref.</i>	<i>Part Number</i>	<i>Qty.</i>	<i>Description</i>	<i>Ref.</i>	<i>Part Number</i>	<i>Qty.</i>	<i>Description</i>
10	115-3018	3	Nozzle Holder Kit	110	99-8311	3	Washer-Adjust (0.20MM)
20	121-2411	3	Nut	110	99-8312	3	Washer-Adjust (0.30MM)
30	99-8302	3	Washer-Adjusting	110	99-8313	3	Washer-Adjust (0.40MM)
40	99-8303	3	Spring-Nozzle	110	99-8314	3	Washer-Adjust (0.50MM)
50	99-8304	3	Spacer-Distance	110	99-8315	3	Washer-Adjust (0.52MM)
60	99-8305	3	Rod-Push	110	99-8316	3	Washer-Adjust (0.54MM)
70	99-8306	3	Nut-Nozzle	110	99-8317	3	Washer-Adjust (0.56MM)
80	99-8307	3	Washer-Plain	110	99-8318	3	Washer-Adjust (0.58MM)
90	115-3020	3	Piece-Nozzle	110	99-8319	3	Washer-Adjust (0.80MM)
100	99-8309	3	Adjusting Washer ASM	120	98-7676	3	Gasket
110	99-8310	3	Washer-Adjust (0.10MM)	130	98-7677	3	Seal-Heat

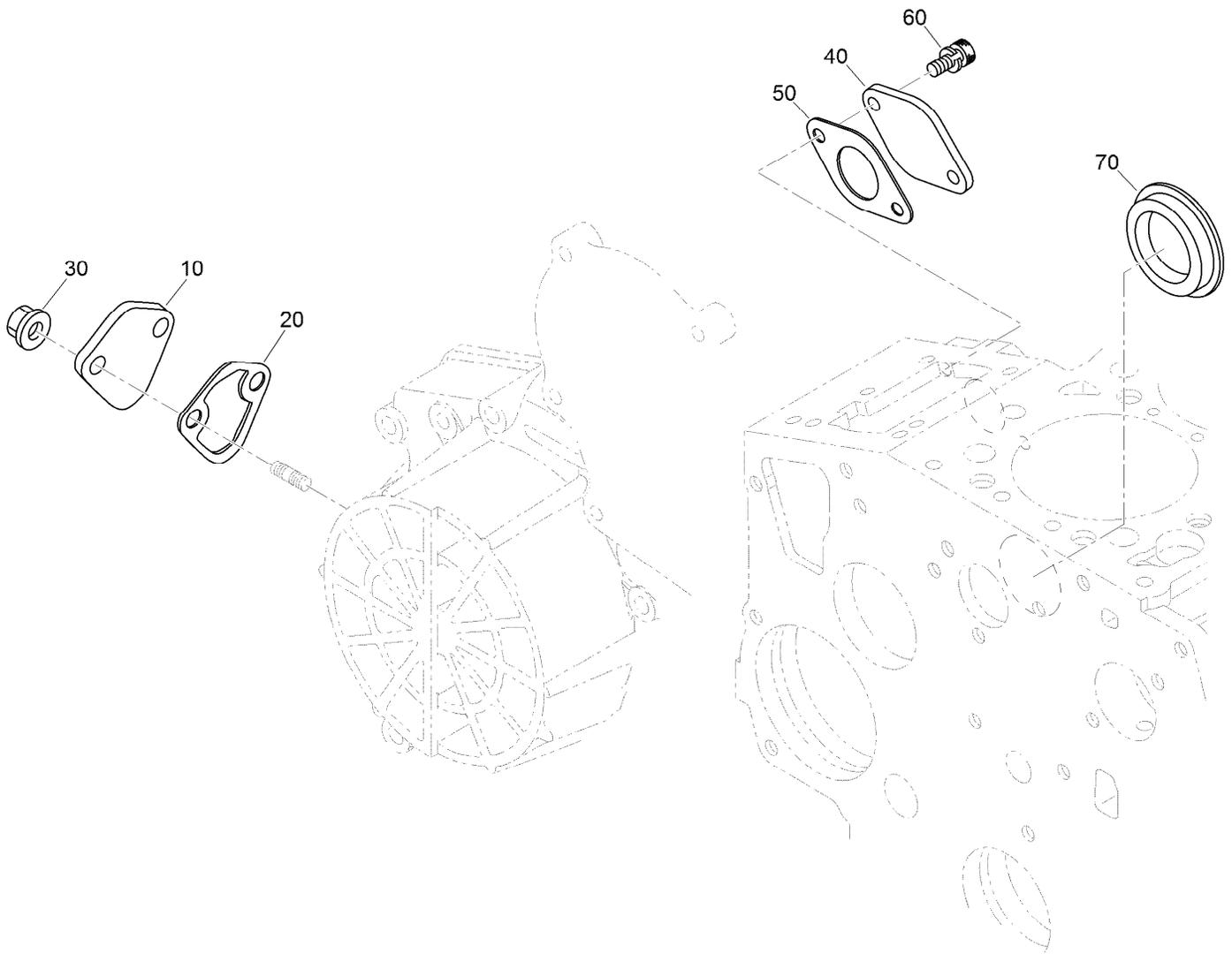

Cover Assembly

Ref.	Part Number	Qty.	Description
10	99-3514	1	Cover
20	117-7562	1	Gasket-Pump, Fuel
30	100-2203	2	Nut-Flange
40	127-0419	1	Cover-Solenoid
50	98-9683	1	Gasket-Cover, Solenoid
60	130-1155	2	Screw-HSH
70	112-7016	1	Cover-Pump

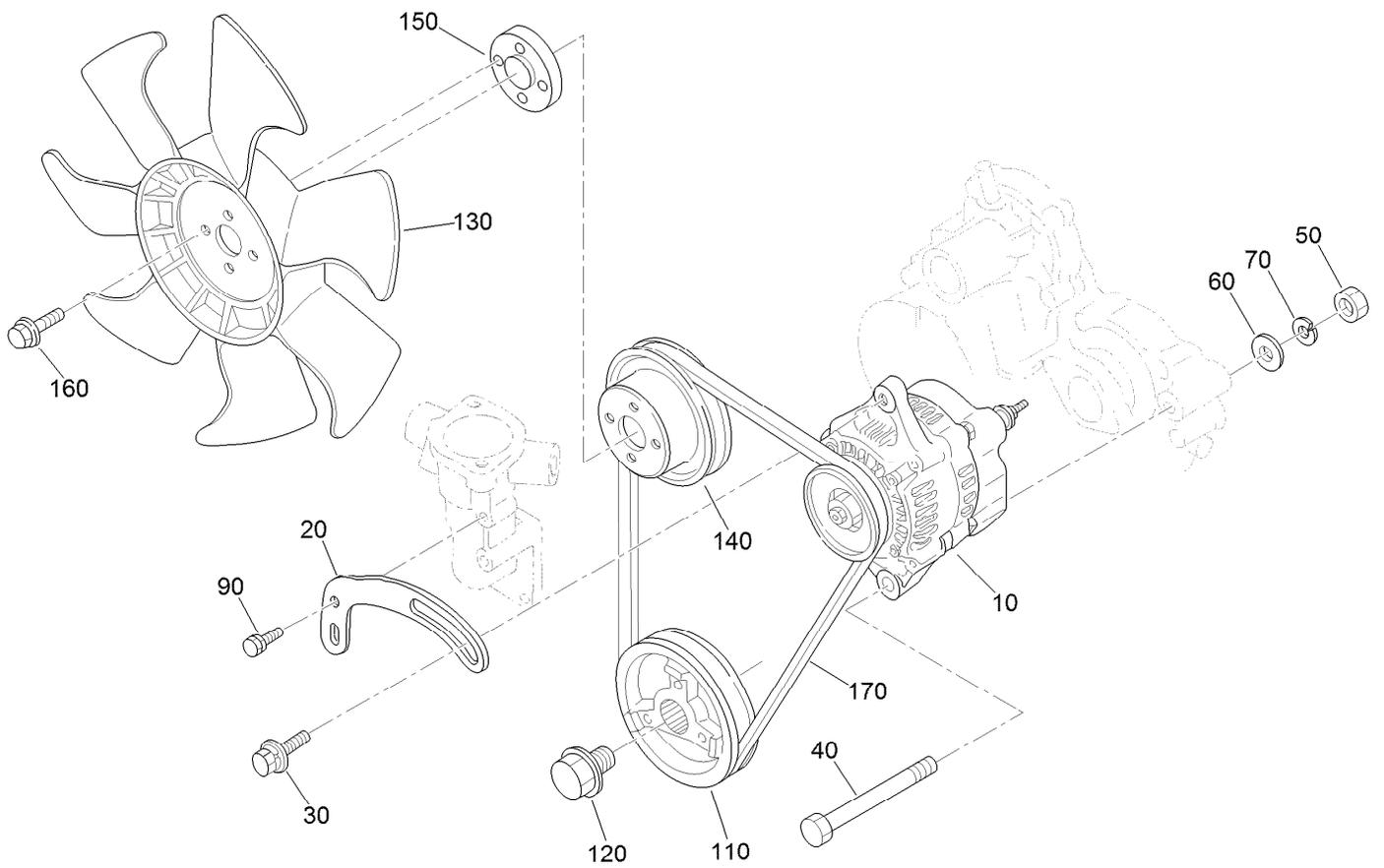

Alternator, Pulley and Fan Assembly

Ref.	Part Number	Qty.	Description
10	131-6557	1	Alternator ASM
20	112-7047	1	Stay-Dynamo
30	108-7088	1	Bolt
40	98-9360	1	Bolt
50	98-7737	1	Nut
60	98-9366	1	Washer-Plain
70	98-7738	1	Washer-Spring
90	98-7692	1	Bolt
110	98-9473	1	Pulley-Drive, Fan
120	98-9585	1	Bolt
130	110-0966	1	Fan-Cooling
140	130-1567	1	Pulley-Fan
150	108-2872	1	Collar-Fan
160	108-2873	4	Bolt-Flange
170	104-3494	1	Belt-V

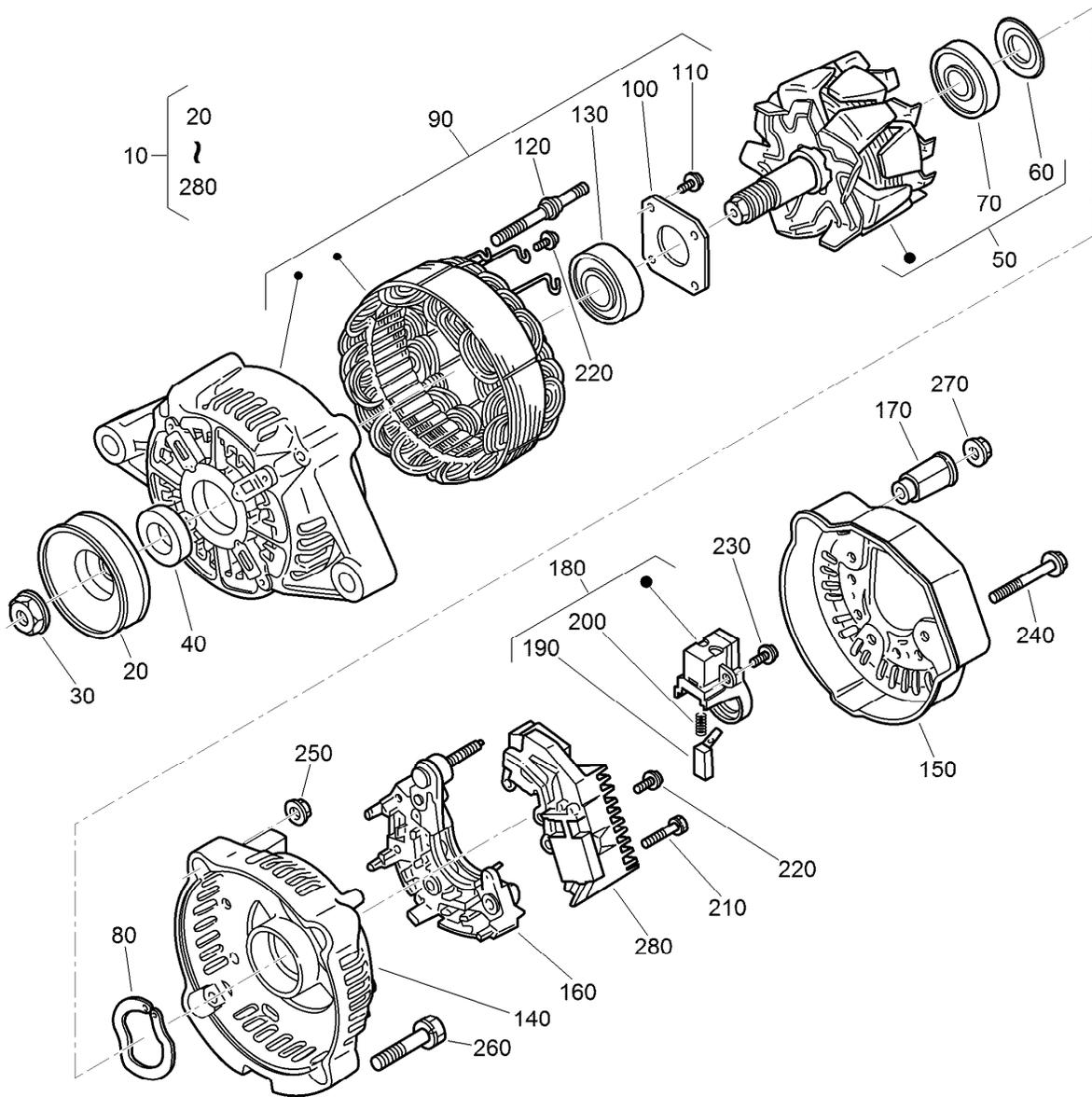

Alternator Assembly No. 131-6557

Ref.	Part Number	Qty.	Description	Ref.	Part Number	Qty.	Description
10	131-6557	1	Alternator ASM	150	107-0140	1	Cover-End
20	98-9453	1	Pulley-Dynamo	160	127-1612	1	Rectifier ASM
30	98-7708	1	Nut	170	98-7722	1	Bushing-Insulation
40	98-7709	1	Collar	180	107-0141	1	Brush Holder ASM
50	107-0136	1	Rotor ASM	190	98-7724	2	Brush
60	98-7711	1	Cover-Bearing	200	98-7725	2	Spring-Brush
70	107-0138	1	Bearing-Ball	210	98-7726	2	Screw-Head, Round
80	98-7713	1	Washer-Thrust	220	98-7727	6	Screw-Head, Round
90	131-6559	1	Frame-End, Drive	230	98-7728	1	Screw-Head, Round
100	98-7715	1	Plate-Retainer	240	98-7729	3	Bolt
110	98-7716	4	Screw-Head, Round	250	98-7730	2	Nut
120	98-7717	2	Bolt-Through	260	98-7731	2	Bolt
130	133-2811	1	Bearing	270	98-7732	1	Nut
140	107-9087	1	Frame-End	280	110-3799	1	Regulator ASM

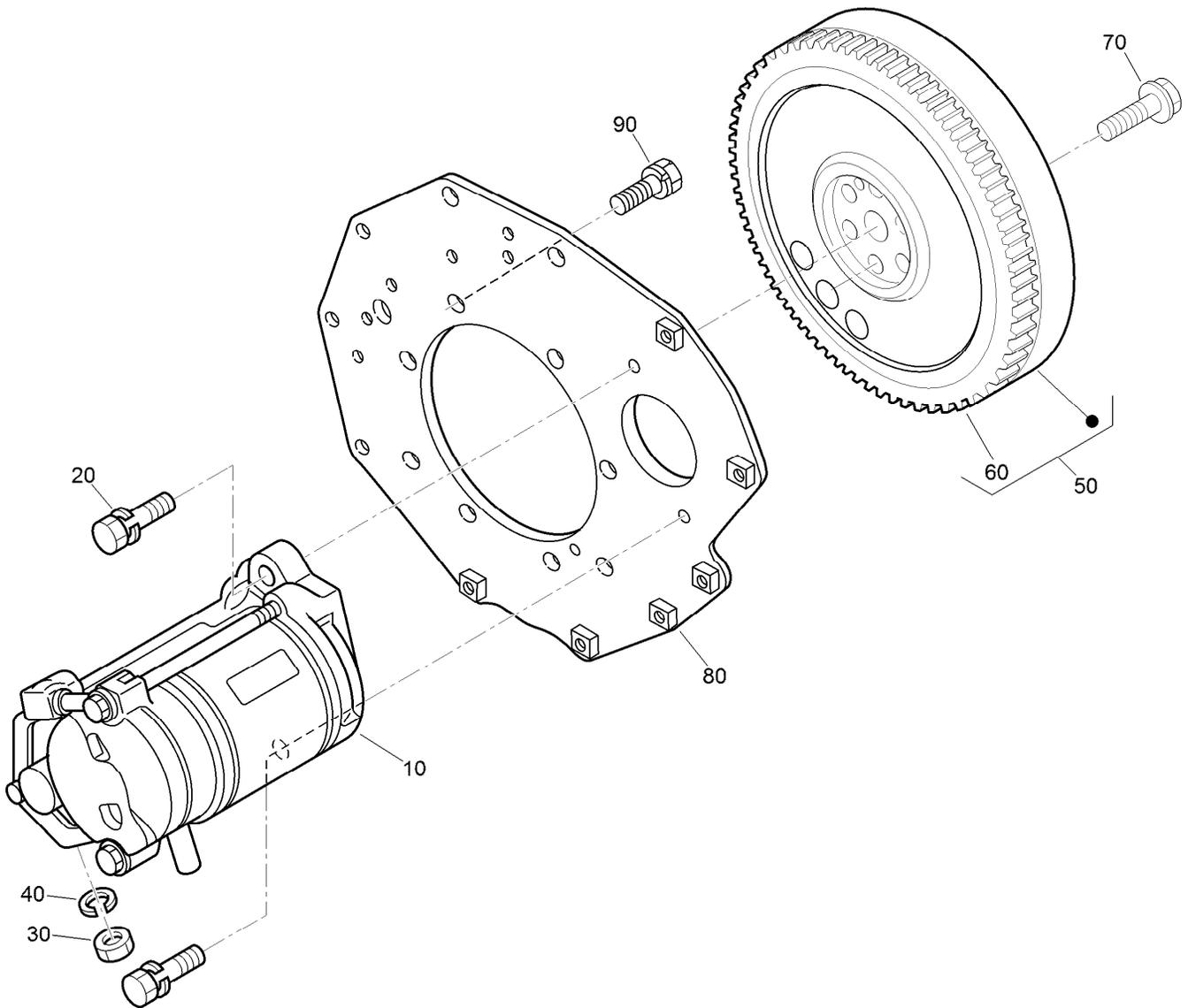

Starter and Flywheel Assembly

Ref.	Part Number	Qty.	Description
10	131-6561	1	Starter ASM
20	98-7697	2	Bolt
30	98-7739	1	Nut
40	105-2893	1	Washer-Spring
50	105-3784	1	Flywheel ASM
60	115-3015	1	Gear-Ring
70	98-9537	6	Bolt-Flywheel
80	98-9486	1	Plate-End, Rear
90	98-9392	8	Bolt

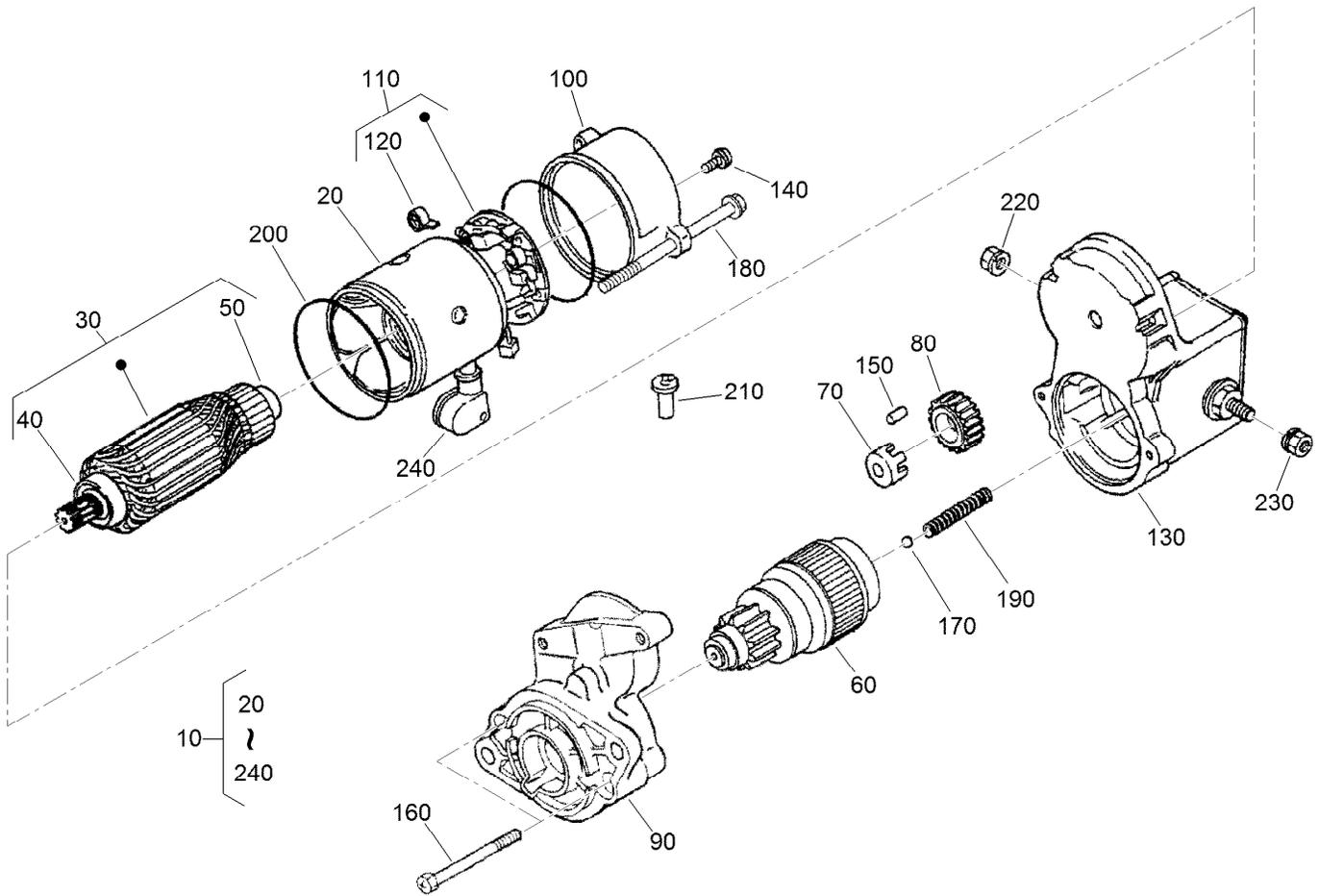

Starter Assembly No. 131-6561

<i>Ref.</i>	<i>Part Number</i>	<i>Qty.</i>	<i>Description</i>	<i>Ref.</i>	<i>Part Number</i>	<i>Qty.</i>	<i>Description</i>
10	131-6561	1	Starter ASM	130	99-8372	1	Magnetic Switch ASM
20	98-7741	1	Yoke ASM	140	98-7758	2	Bolt ASM
30	98-7742	1	Armature ASM	150	98-7753	5	Roller
40	98-7744	1	Bearing	160	98-7756	2	Bolt
50	98-7743	1	Bearing	170	98-7755	1	Ball
60	99-8373	1	Clutch-Running, Over	180	100-9240	2	Bolt
70	98-7752	1	Retainer	190	98-7754	1	Spring
80	98-7751	1	Gear	200	98-7757	2	O-Ring
90	99-8374	1	Frame-End, Drive	210	98-7759	1	Pipe-Drain
100	98-7748	1	Frame-End	220	99-8376	1	Nut-Hex
110	98-7749	1	Brush Holder ASM	230	98-7760	1	Nut-Hex
120	98-7750	4	Spring-Brush	240	110-0020	1	Cover-Terminal

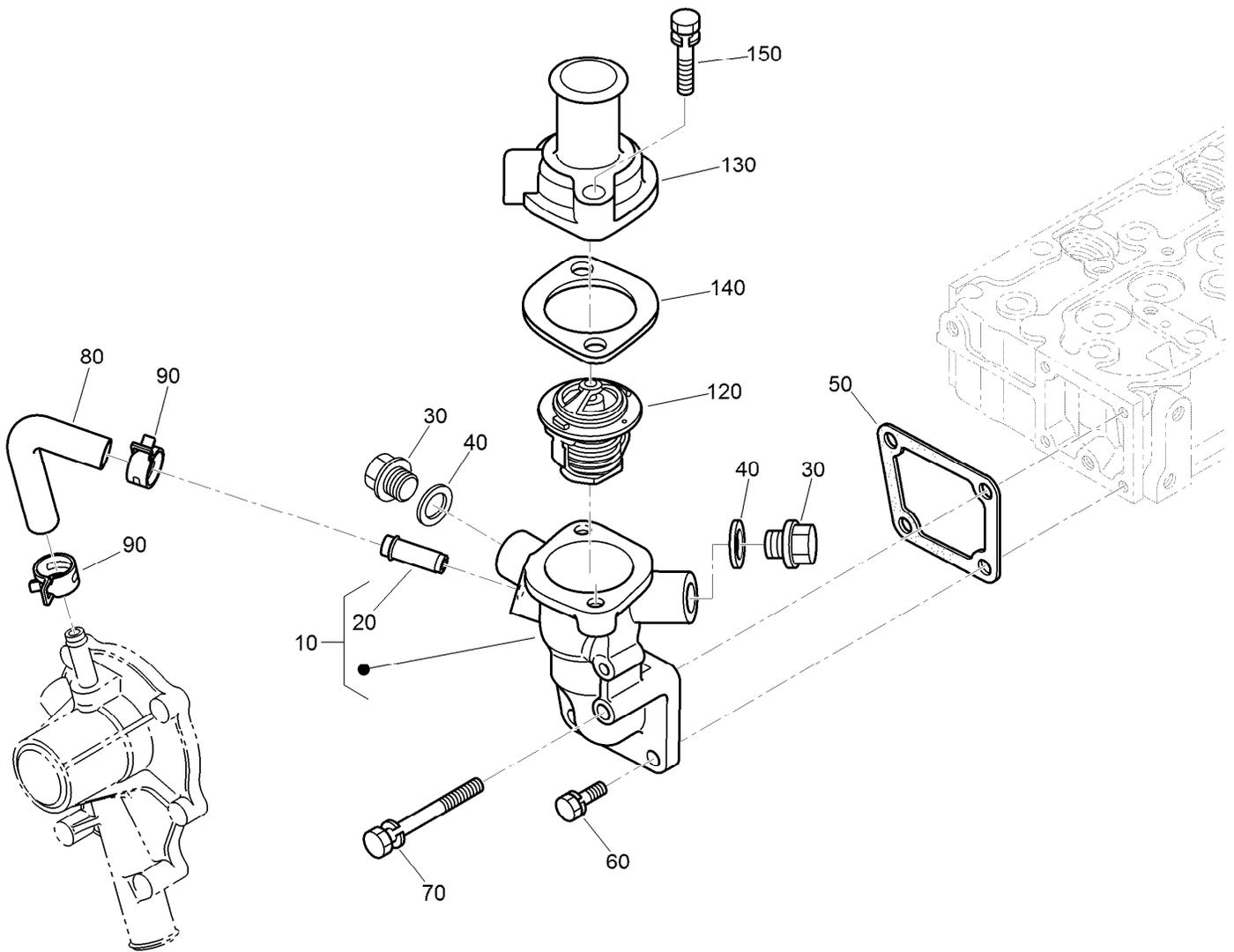

Water Flange and Thermostat Assembly

<i>Ref.</i>	<i>Part Number</i>	<i>Qty.</i>	<i>Description</i>
10	98-9713	1	Water Flange ASM
20	98-9580	1	Pipe-Return, Water
30	105-3747	2	Plug
40	99-3583	2	Gasket
50	98-9638	1	Gasket-Flange, Water
60	98-7692	3	Bolt
70	98-9356	1	Bolt
80	98-9578	1	Pipe-Return, Water
90	125-9078	2	Clamp-Hose
120	98-7778	1	Thermostat ASM
130	98-9471	1	Cover-Thermostat
140	105-3748	1	Gasket-Thermostat
150	98-7777	2	Bolt

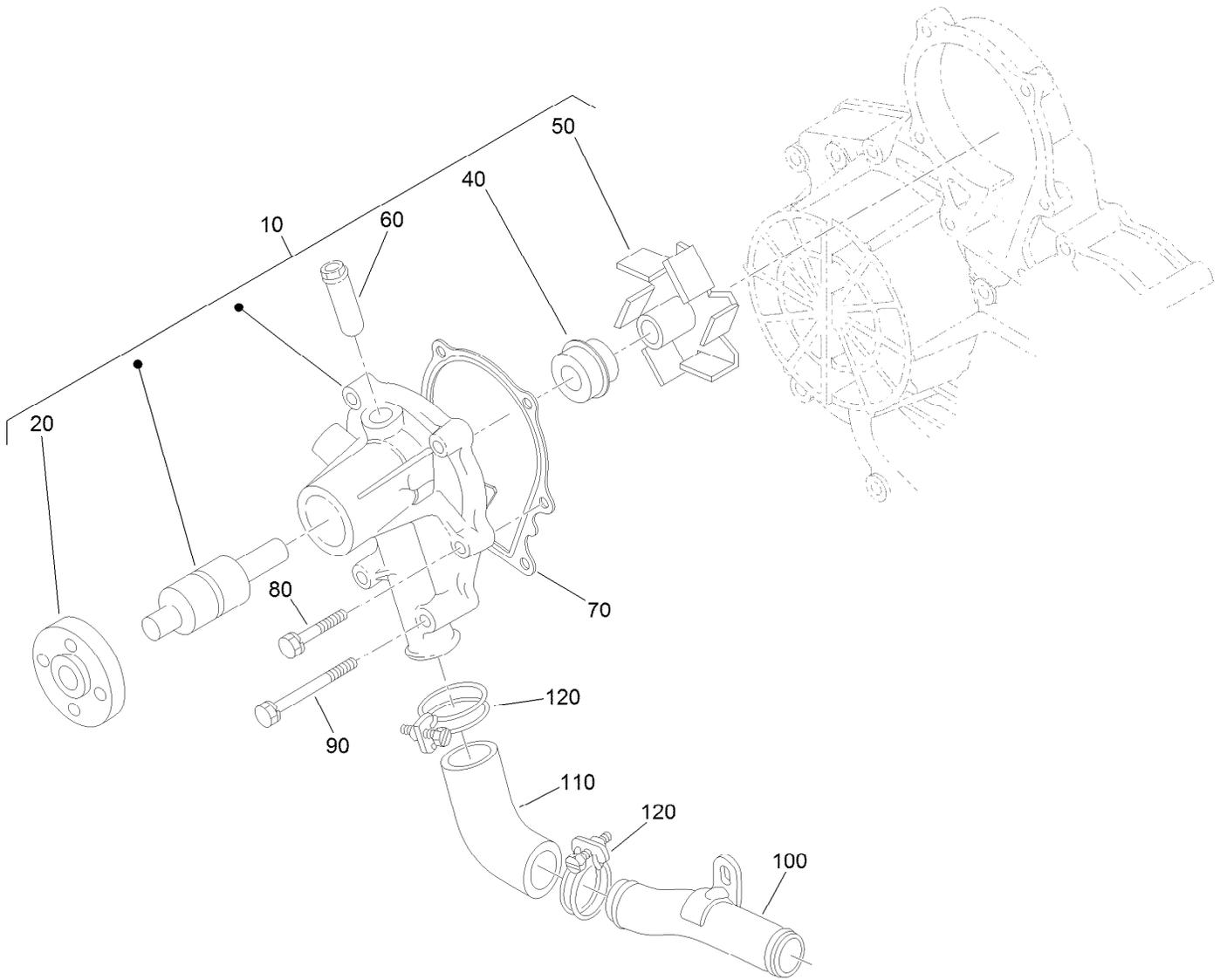

Water Pump Assembly

<i>Ref.</i>	<i>Part Number</i>	<i>Qty.</i>	<i>Description</i>
10	107-9089	1	Water Pump ASM
20	99-3516	1	Flange-Pump, Water
40	105-3750	1	Mechanical Seal ASM
50	112-7017	1	Impeller-Pump, Water
60	100-1932	1	Pipe-Return, Water
70	99-3454	1	Gasket-Pump, Water
80	98-9353	4	Bolt
90	107-9090	2	Bolt
100	98-9716	1	Pipe-Water
110	107-9091	1	Pipe-Water
120	127-0439	2	Clamp-Hose

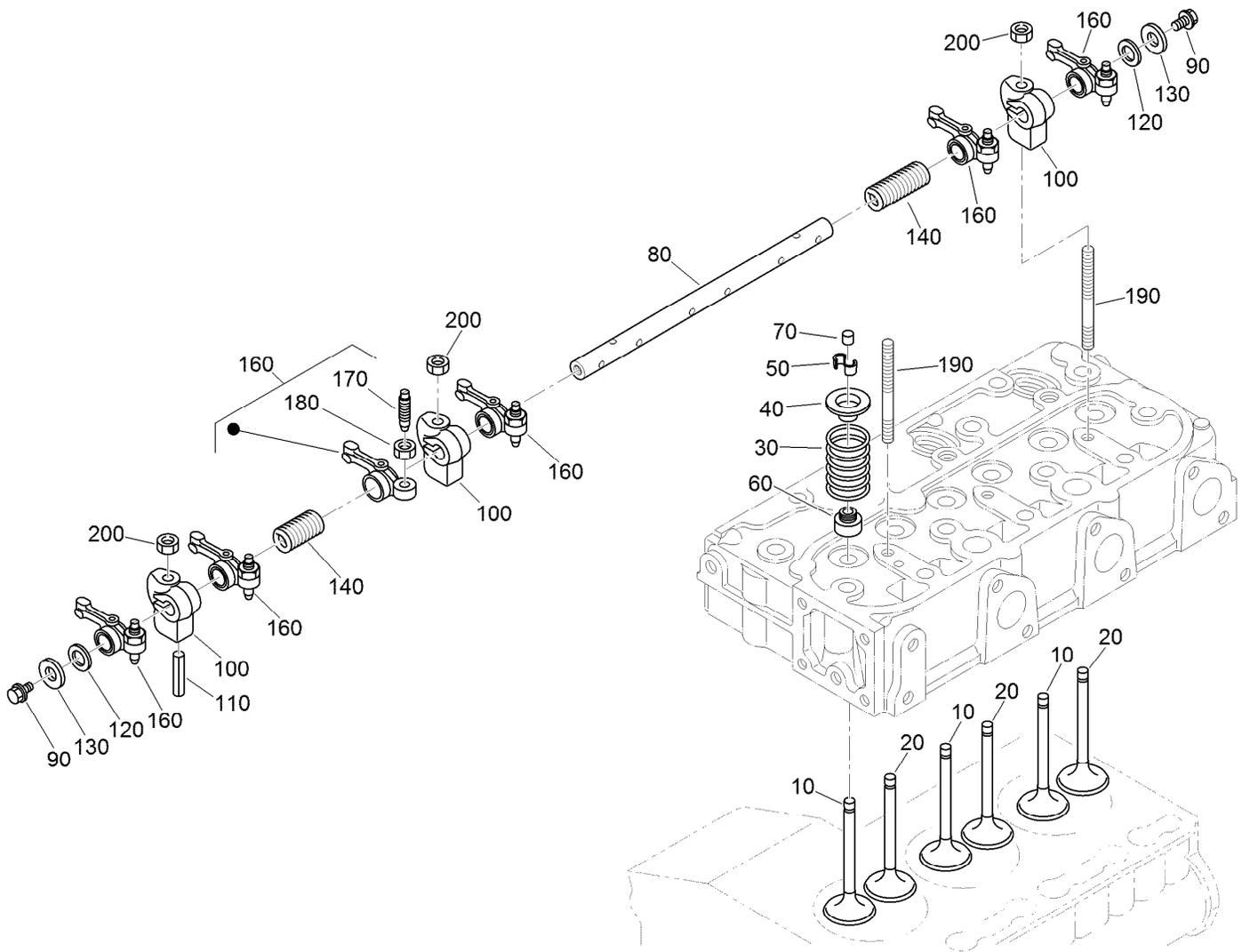

Valve and Rocker Arm Assembly

Ref.	Part Number	Qty.	Description	Ref.	Part Number	Qty.	Description
10	112-7018	3	Valve-Inlet	110	105-3758	1	Pin-Spring
20	120-2564	3	Valve-Exhaust	120	98-9507	2	Washer-Shaft, Rocker Arm
30	98-9648	6	Spring-Valve	130	110-3832	2	Washer-Plain
40	107-9092	6	Retainer-Spring	140	98-9504	2	Spring-Arm, Rocker
50	117-7572	6	Collet-Spring, Valve	160	112-7020	6	Rocker Arm ASM
60	99-8385	6	Seal-Stem, Valve	170	98-9502	6	Screw-Adjusting
70	98-9497	6	Cap-Valve	180	98-9503	6	Nut
80	130-1248	1	Shaft-Arm, Rocker	190	98-9506	3	Stud
90	99-8363	2	Bolt-Flange	200	131-6563	3	Nut-Flange
100	98-9505	3	Bracket-Arm, Rocker				

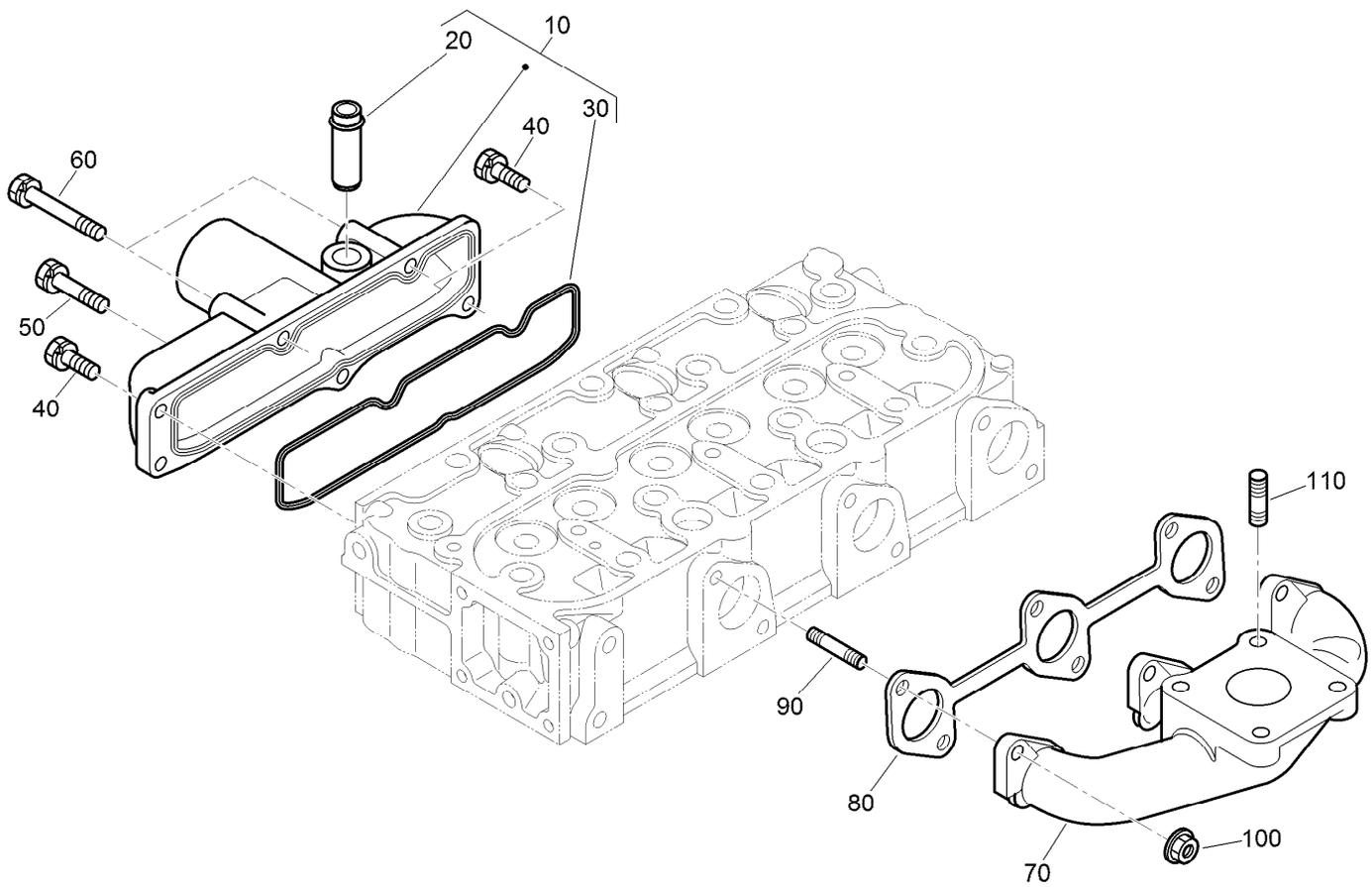

Inlet and Exhaust Manifold Assembly

<i>Ref.</i>	<i>Part Number</i>	<i>Qty.</i>	<i>Description</i>
10	108-6577	1	Inlet Manifold ASM
20	98-9492	1	Joint-Pipe, Breather
30	98-9609	1	Gasket-Manifold, Inlet
40	127-0403	3	Bolt-Flange
50	98-9353	1	Bolt
60	125-9063	2	Bolt-Sems
70	107-9093	1	Manifold-Exhaust
80	99-8327	1	Gasket-Manifold, Exhaust
90	98-9588	6	Stud
100	98-9665	6	Nut
110	98-7769	4	Stud

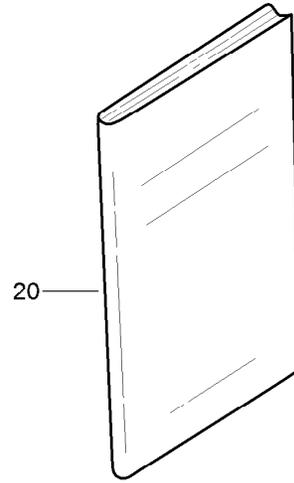
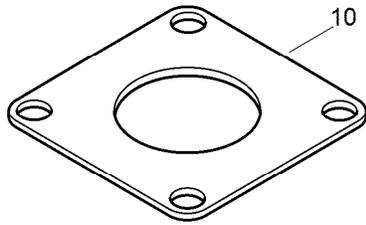

Miscellaneous Engine Parts

<i>Ref.</i>	<i>Part Number</i>	<i>Qty.</i>	<i>Description</i>
10	99-8343	1	Gasket-Muffler
20	130-1543	1	Manual-Operator

Attachments and Accessories

For 03674 Reelmaster 5010-H Traction Unit

Product Name	Model/Part
Air Ride Seat Suspension Kit.....	03667
Wheel Weight Kit	104-1478
Premium All Season Hydraulic Fluid (55 Gallon Drum)	108-1177
Premium All Season Hydraulic Fluid (5 Gallon Pail).....	108-1178
Premium All Purpose Grease (Tube)	108-1190
Air Cleaner Safety Element.....	108-3813
22in Combo Blade	108-7395-03
ROPS Extension Kit.....	110-8030
Operator Fan Kit - US Sales Only, 3in ROPS Post	110-8804
Weight Plate	110-8985-03
22in High Lift Blade.....	114-0434-03
22in Atomic Blade.....	114-0435-03
Roller Scraper Kit.....	117-0149
Mulching Kit	117-0185
22in Angle Sail Blade.....	117-0209-03
Hydraulic Hose Kit	117-0289
22in Rotary Cutting Unit Sectional Roller ASM	117-0297
Premium Synthetic Bio-Degradable Hydraulic Fluid (5 Gallon Pail)	119-2157
Premium Synthetic Bio-Degradable Hydraulic Fluid (55 Gallon Drum).....	119-2158
Service Pack-Combo Blade	119-6957
Large Seat Cover.....	120-5179
Premium Engine Oil 10w30 (55 Gallon Drum)	121-6392
Premium Engine Oil 10w30 (5 Gallon Pail)	121-6393
Canopy Completion Kit.....	130-5895
400-Hour Filter Maintenance Kit	30055
Universal Sunshade	30349
22in Rotary Cutting Unit.....	30845
Spark Arrestor	98-9099

Notes:

Notes:



Count on it.