



Groundsmaster[®] 4700-D

Groundsmaster Traction Unit

Model No. 30868—Serial No. 230000701 and Up

Operator's Manual





Warning



CALIFORNIA

Proposition 65 Warning

Diesel engine exhaust and some of its constituents are known to the State of California to cause cancer, birth defects, and other reproductive harm.

Contents

	Page
Introduction	3
Safety	3
Safe Operating Practices	3
Toro Riding Mower Safety	5
Sound Pressure Level	6
Sound Power Level	6
Vibration Level	7
Safety and Instruction Decals	7
Specifications	12
Traction Unit Specifications	12
Measurements	13
Optional Equipment	13
Setup	14
Loose Parts	14
Installing the Seat, Seat Belt, and Manual Tube ..	14
Greasing the Machine	14
Before Operating	15
Checking the Engine Oil	15
Checking the Cooling System	15
Filling the Fuel Tank	16
Checking the Hydraulic Fluid	17
Checking the Planetary Gear Drive Oil	17
Checking the Rear Axle Lubricant	18
Check Tire Pressure	18
Checking the Torque of the Wheel Nuts	18
Operation	19
Controls	19

Starting and Stopping the Engine	21
Bleeding the Fuel System	21
Checking the Interlock Switches	22
Pushing or Towing the Machine	23
Jacking Points	23
Tie Downs	23
Operating Characteristics	23
Operating Tips	24
Standard Control Module (SCM)	26
Maintenance	28
Recommended Maintenance Schedule	28
Daily Maintenance Checklist	29
Service Interval Chart	30
Greasing the Bearings and Bushings	31
Hood Removal	32
Servicing the Air Cleaner	33
Servicing the Engine Oil and Filter	34
Servicing the Fuel System	34
Bleeding Air from the Injectors	35
Servicing the Engine Cooling System	36
Servicing the Alternator Belt	36
Adjusting the Throttle	37
Servicing the Spark Arrestor Muffler	37
Changing the Hydraulic Fluid	37
Replacing the Hydraulic Filters	37
Checking the Hydraulic Lines and Hoses	38
Hydraulic System Test Ports	38
Adjusting Counterbalance	40
Adjusting the Traction Drive for Neutral	40
Adjusting the Service Brakes	40
Changing the Planetary Gear Drive Oil	41
Changing the Rear Axle Lubricant	41
Checking the Rear Wheel Toe-In	42
Charging and Connecting the Battery	42
Battery Care	43
Fuses	43
Electrical Schematic	44
Hydraulic Schematic	45
Preparing for Seasonal Storage	46
The Toro General Commercial Products Warranty ..	48

Introduction

Read this manual carefully to learn how to operate and maintain your product properly. The information in this manual can help you and others avoid injury and product damage. Although Toro designs and produces safe products, you are responsible for operating the product properly and safely.

Whenever you need service, genuine Toro parts, or additional information, contact an Authorized Service Dealer or Toro Customer Service and have the model and serial numbers of your product ready. The numbers can be found on a plate that is mounted on the left side of the operator platform, behind the footrest.

Write the product model and serial numbers in the space below:

Model No. _____
Serial No. _____

This manual identifies potential hazards and has special safety messages that help you and others avoid personal injury and even death. *Danger*, *Warning*, and *Caution* are signal words used to identify the level of hazard. However, regardless of the hazard, be extremely careful.

Danger signals an extreme hazard that *will* cause serious injury or death if you do not follow the recommended precautions.

Warning signals a hazard that *may* cause serious injury or death if you do not follow the recommended precautions.

Caution signals a hazard that may cause minor or moderate injury if you do not follow the recommended precautions.

This manual uses two other words to highlight information.

Important calls attention to special mechanical information and **Note:** emphasizes general information worthy of special attention.

Safety

This machine meets or exceeds CEN standard EN 836:1997 (when appropriate decals applied), and ANSI B71.4-1999 specifications in effect at the time of production when equipped with required weights as listed in the weight chart.

Improper use or maintenance by the operator or owner can result in injury. To reduce the potential for injury, comply with these safety instructions and always pay attention to the safety alert  symbol, which means

CAUTION, WARNING, or DANGER—“personal safety instruction.” Failure to comply with the instruction may result in personal injury or death.

Safe Operating Practices

The following instructions are from the CEN standard EN 836:1997, ISO standard 5395:1990, and ANSI B71.4-1999.

Training

- Read the operator’s manual and other training material carefully. Be familiar with the controls, safety signs, and the proper use of the equipment.
- If the operator or mechanic can not read the language of this manual, it is the owner’s responsibility to explain this material to them.
- Never allow children or people unfamiliar with these instructions to use or service the mower. Local regulations may restrict the age of the operator.
- Never mow while people, especially children, or pets are nearby.
- Keep in mind that the operator or user is responsible for accidents or hazards occurring to other people or their property.
- Do not carry passengers.
- All drivers and mechanics should seek and obtain professional and practical instruction. The owner is responsible for training the users. Such instruction should emphasize:
 - the need for care and concentration when working with ride-on machines;
 - control of a ride-on machine sliding on a slope will not be regained by the application of the brake. The main reasons for loss of control are:
 - insufficient wheel grip;
 - being driven too fast;
 - inadequate braking;
 - the type of machine is unsuitable for the task;
 - lack of awareness of the effect of ground conditions, especially slopes;
- The owner/user can prevent and is responsible for accidents or injuries occurring to himself or herself, other people, or property.

Preparation

- While mowing, always wear substantial footwear, long trousers, hard hat, safety glasses, and hearing protection. Long hair, loose clothing, or jewelry may get tangled in moving parts. Do not operate the equipment when barefoot or wearing open sandals.
- Thoroughly inspect the area where the equipment is to be used and remove all objects which may be thrown by the machine.
- **Warning**—Fuel is highly flammable. Take the following precautions:
 - Store fuel in containers specifically designed for this purpose.
 - Refuel outdoors only and do not smoke while refueling.
 - Add fuel before starting the engine. Never remove the cap of the fuel tank or add fuel while the engine is running or when the engine is hot.
 - If fuel is spilled, do not attempt to start the engine but move the machine away from the area of spillage and avoid creating any source of ignition until fuel vapors have dissipated.
 - Replace all fuel tank and container caps securely.
- Replace faulty silencers/mufflers.
- Evaluate the terrain to determine what accessories and attachments are needed to properly and safely perform the job. Only use accessories and attachments approved by the manufacturer.
- Check that operator's presence controls, safety switches and shields are attached and functioning properly. Do not operate unless they are functioning properly.

Operation

- Do not operate the engine in a confined space where dangerous carbon monoxide fumes can collect.
- Mow only in daylight or in good artificial light.
- Before attempting to start the engine, disengage all blade attachment clutches, shift into neutral, and engage the parking brake.
- Do not put hands or feet near or under rotating parts. Keep clear of the discharge opening at all times.
- Do not use on slopes of more than 15°.
- Remember there is no such thing as a safe slope. Travel on grass slopes requires particular care. To guard against overturning:
 - do not stop or start suddenly when going up or downhill;

- machine speeds should be kept low on slopes and during tight turns;
- stay alert for humps and hollows and other hidden hazards;
- never mow across the face of the slope, unless the mower is designed for this purpose.
- Use counterweight(s) or wheel weights when suggested in the operator's manual.
- Stay alert for holes in the terrain and other hidden hazards.
- Watch out for traffic when crossing or near roadways.
- Stop the blades from rotating before crossing surfaces other than grass.
- When using any attachments, never direct discharge of material toward bystanders nor allow anyone near the machine while in operation.
- Never operate the machine with damaged guards, shields, or without safety protective devices in place. Be sure all interlocks are attached, adjusted properly, and functioning properly.
- Do not change the engine governor settings or overspeed the engine. Operating the engine at excessive speed may increase the hazard of personal injury.
- Before leaving the operator's position:
 - stop on level ground;
 - disengage the power take-off and lower the attachments;
 - change into neutral and set the parking brake;
 - stop the engine and remove the key.

Important Allow engine to idle for 5 minutes before shutting it off after a full load operation. Failure to do so may lead to turbo-charger trouble.

- Disengage drive to attachments when transporting or not in use.
- Stop the engine and disengage drive to attachment
 - before refuelling;
 - before removing the grass catcher/catchers;
 - before making height adjustment unless adjustment can be made from the operator's position.
 - before clearing blockages;
 - before checking, cleaning or working on the mower;
 - after striking a foreign object or if an abnormal vibration occurs. Inspect the mower for damage and make repairs before restarting and operating the equipment.

- Reduce the throttle setting during engine run-out and, if the engine is provided with a shut-off valve, turn the fuel off at the conclusion of mowing.
- Keep hands and feet away from the cutting units.
- Look behind and down before backing up to be sure of a clear path.
- Slow down and use caution when making turns and crossing roads and sidewalks. Stop blades from rotating.
- Be aware of the mower discharge direction and do not point it at anyone.
- Do not operate the mower under the influence of alcohol or drugs
- Use care when loading or unloading the machine into a trailer or truck
- Use care when approaching blind corners, shrubs, trees, or other objects that may obscure vision.
- Carefully release pressure from components with stored energy.
- Disconnect battery and remove spark plug wire (gas engine only) before making any repairs. Disconnect the negative terminal first and the positive last. Reconnect positive first and negative last.
- Use care when checking the blades. Wear gloves and use caution when servicing them.
- Keep hands and feet away from moving parts. If possible, do not make adjustments with the engine running.
- Charge batteries in an open well ventilated area, away from spark and flames. Unplug charger before connecting or disconnecting from battery. Wear protective clothing and use insulated tools.

Maintenance and Storage



- Keep all nuts, bolts and screws tight to be sure the equipment is in safe working condition.
- Never store the equipment with fuel in the tank inside a building where fumes may reach an open flame or spark.
- Allow the engine to cool before storing in any enclosure.
- To reduce the fire hazard, keep the engine, silencer/muffler, battery compartment and fuel storage area free of grass, leaves, or excessive grease.
- Check the grass catcher frequently for wear or deterioration.
- Keep all parts in good working condition and all hardware and hydraulic fittings tightened. Replace all worn or damaged parts and decals.
- If the fuel tank has to be drained, do this outdoors.
- Be careful during adjustment of the machine to prevent entrapment of the fingers between moving blades and fixed parts of the machine.
- On multi-spindle mowers, take care as rotating one blade can cause other blades to rotate.
- Disengage drives, lower the cutting units, set parking brake, stop engine and remove key and disconnect spark plug wire (gas engine only). Wait for all movement to stop before adjusting, cleaning or repairing.
- Clean grass and debris from cutting units, drives, silencers/mufflers, and engine to help prevent fires. Clean up oil or fuel spillage.
- Use jack stands to support components when required.

Toro Riding Mower Safety

The following list contains safety information specific to Toro products or other safety information that you must know that is not included in the CEN, ISO, or ANSI standard.

This product is capable of amputating hands and feet and throwing objects. Always follow all safety instructions to avoid serious injury or death.

Use of this product for purposes other than its intended use could prove dangerous to user and bystanders.

	Warning	
<p>Engine exhaust contains carbon monoxide, which is an odorless, deadly poison that can kill you.</p> <p>Do not run engine indoors or in an enclosed area.</p>		

- Know how to stop the engine quickly.
- Do not operate the machine while wearing tennis shoes or sneakers.
- Wearing safety shoes and long pants is advisable and required by some local ordinances and insurance regulations.
- Handle fuel carefully. Wipe up any spills.
- Check the safety interlock switches daily for proper operation. If a switch should fail, replace the switch before operating the machine. After every two years, replace all interlock switches in the safety system, whether they are working properly or not.
- Before starting the engine, sit on the seat.
- Using the machine demands attention. To prevent loss of control:

- Do not drive close to sand traps, ditches, creeks, embankments, or other hazards.
- Reduce speed when making sharp turns. Avoid sudden stops and starts.
- When near or crossing roads, always yield the right-of-way.
- Apply the service brakes when going downhill to keep forward speed slow and to maintain control of the machine.
- When operating a machine on slopes, by banks, or drop offs, always have ROPS (roll-over protection system) installed.
- When operating a machine with ROPS (roll-over protection system) always use the seat belt and make sure seat pivot retainer pin is installed (GM only).
- Raise the cutting units when driving from one work area to another.
- Do not touch the engine, silencer/muffler, or exhaust pipe while the engine is running or soon after it has stopped because these areas could be hot enough to cause burns.
- On any hill, there is the possibility of tipping or rolling over, but the risk increases as the slope angle increases. Steep hills should be avoided.
 - Cutting units must be lowered when going down slopes to maintain steering control
- Engage traction drive slowly, always keep foot on traction pedal, especially when traveling downhill.
 - Use reverse on traction pedal for braking.
- If the machine stalls when climbing a slope, do not turn the machine around. Always back slowly, straight down the slope.
- When a person or pet appears unexpectedly in or near the mowing area, **stop mowing**. Careless operation, combined with terrain angles, ricochets, or improperly positioned guards can lead to thrown object injuries. Do not resume mowing until the area is cleared.
- Before disconnecting or performing any work on the hydraulic system, all pressure in the system must be relieved by stopping the engine and lowering the cutting units and attachments to the ground.
- Check all fuel lines for tightness and wear on a regular basis. Tighten or repair them as needed.
- If the engine must be running to perform a maintenance adjustment, keep hands, feet, clothing, and any parts of the body away from the cutting units, attachments, and any moving parts.
- To ensure safety and accuracy, have an Authorized Toro Distributor check the maximum engine speed with a tachometer.
- If major repairs are ever needed or if assistance is desired, contact an Authorized Toro Distributor.
- Use only Toro-approved attachments and replacement parts. The warranty may be voided if used with unapproved attachments.

Sound Pressure Level

This unit has an equivalent continuous A-weighted sound pressure level at the operator ear of 90 dBA, based on measurements of identical machines per Directive 98/37/EC and amendments.

Sound Power Level

This unit has a guaranteed sound power level of 105 dBA/1 pW, based on measurements of identical machines per Directive 2000/14/EC and amendments.

Maintenance and Storage

- Make sure all hydraulic line connectors are tight and all hydraulic hoses and lines are in good condition before applying pressure to the system.
- Keep your body and hands away from pin hole leaks or nozzles that eject hydraulic fluid under high pressure. Use paper or cardboard, not your hands, to search for leaks. Hydraulic fluid escaping under pressure can have sufficient force to penetrate the skin and cause serious injury. Seek immediate medical attention if fluid is injected into skin.

Vibration Level

Hand-Arm

This unit does not exceed a vibration level of 2.5 m/s² at the hands based on measurements of identical machines per ISO 5349 procedures.

Whole Body

This unit does not exceed a vibration level of 0.5 m/s² at the posterior based on measurements of identical machines per ISO 2631 procedures.

Safety and Instruction Decals



Safety decals and instructions are easily visible to the operator and are located near any area of potential danger. Replace any decal that is damaged or lost.



104-0131

1. Read the *Operator's Manual*.

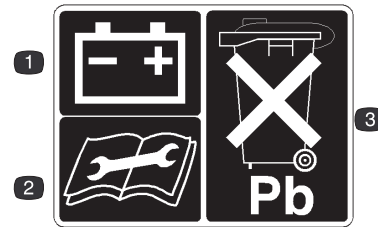

93-6668

1. Battery
2. Read the instructions before servicing or performing maintenance.
3. Contains lead; do not discard.

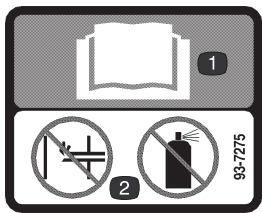

93-7275

1. Read the operator's manual.
2. Do not use starting aids.



93-6680

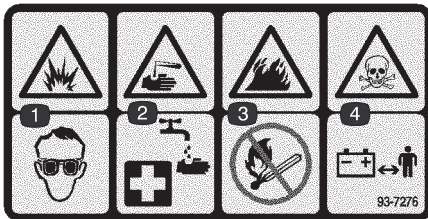

93-7276

1. Explosion hazard—wear eye protection.
2. Caustic liquid/chemical burn hazard—to perform first aid, flush with water.
3. Fire hazard—No fire, open flames, or smoking.
4. Poison hazard—keep children a safe distance from the battery.

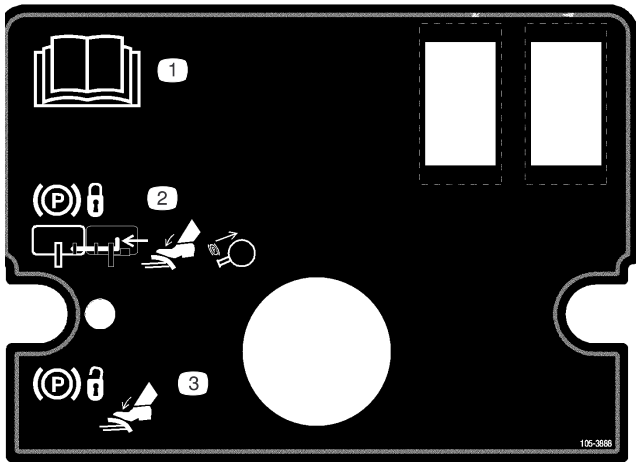

105-3888

1. Read the *Operator's Manual*.
2. To lock the parking brake, secure the brake pedals with the locking pin, press the brake pedals, and pull out the the parking brake knob.
3. To unlock the parking brake, press the brake pedal.

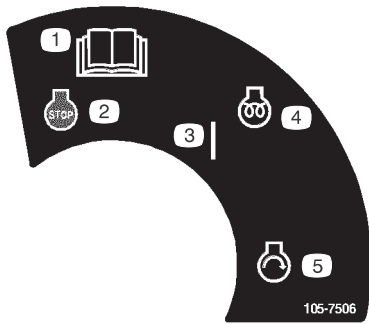

105-7506

- | | |
|--------------------------------------|-------------------|
| 1. Read the <i>Operator's Manual</i> | 3. On |
| 2. Engine—stop | 4. Engine—preheat |
| | 5. Engine—start |

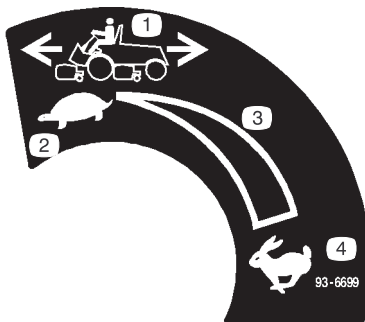

93-6699

- | | |
|------------------|--------------------------------|
| 1. Machine speed | 3. Continuous variable setting |
| 2. Slow | 4. Fast |

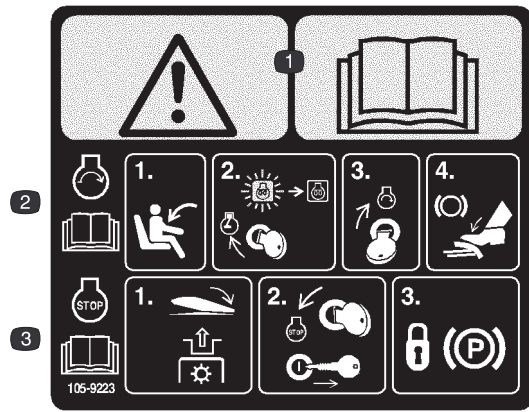

105-9223

(Affix over part no. 105-3890 for CE)

1. Warning—read the *Operator's Manual*.
2. To start the engine (read the *Operator's Manual*), sit in the operator's position, turn the ignition key to the Engine—run position until the Engine—preheat light turns off, turn the ignition key to the Engine—start position, and press the brake pedal.
3. To stop the engine (read the *Operator's Manual*), disengage the PTO, turn the ignition key to the Engine—stop position, remove the key, and lock the parking brake.

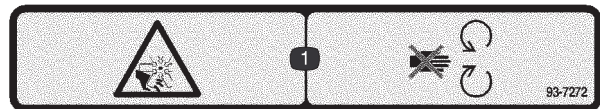

93-7272

1. Cutting/dismemberment hazard, fan—stay away from moving parts.

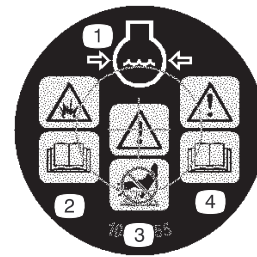

106-6755

- | | |
|---|--|
| 1. Engine coolant under pressure | 3. Warning—do not touch the hot surface. |
| 2. Explosion hazard—read the <i>Operator's Manual</i> . | 4. Warning—read the <i>Operator's Manual</i> . |

GROUNDMASTER 4500/4700 QUICK REFERENCE AID

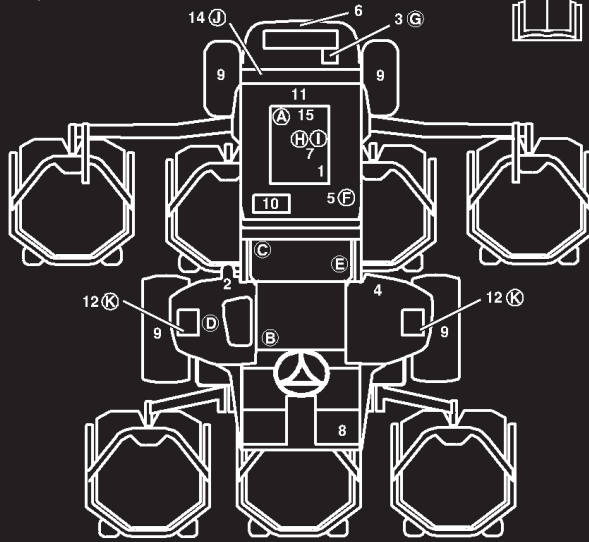

CHECK/SERVICE (DAILY)

1. ENGINE OIL LEVEL
2. HYDRAULIC OIL FLUID LEVEL
3. ENGINE COOLANT LEVEL
4. FUEL - DIESEL ONLY
5. FUEL/WATER SEPARATOR
6. RADIATOR SCREEN
7. AIR CLEANER
8. BRAKE FUNCTION
9. TIRE PRESSURE: 20 PSI / 1.40 BAR
- WHEEL NUT TORQUE: 93 FT/LB (127 Nm)

CHECK/SERVICE (SEE OPERATOR'S MANUAL)

10. BATTERY
11. BELTS (FAN, ALT.)
12. PLANETARY GEAR DRIVE
13. INTERLOCK SYSTEM
14. REAR AXLE
15. ENGINE OIL DRAIN
(13/16" OR 21 MM SOCKET)
16. GREASING (SEE OPERATOR'S MANUAL)

SPECIFICATIONS/CHANGE INTERVALS

SEE OPERATOR'S MANUAL FOR INITIAL CHANGES.	FLUID TYPE	CAPACITY	CHANGE INTERVAL		FILTER PART NO.	
			FLUID	FILTER		
(A) ENGINE OIL	10W-30 CE	8 QUARTS	100 HOURS	100 HOURS	98-7431	
(B) HYDRAULIC FLUID	ISO VG 46/68	7.5 GALLONS	800 HOURS	800 HOURS	75-1310	
(C) HYDRAULIC FILTER				800 HOURS	94-2621	
(D) HYDRAULIC BREATHER				800 HRS/YRLY	68-6150	
(E) FILTER, IN-LINE FUEL				400 HOURS	98-7612	
(F) FUEL SYSTEM	> 32 F	NO. 2 DIESEL	21 GALLONS	800 HOURS	400 HOURS/ YEARLY	98-9764
	< 32 F	NO. 1 DIESEL		DRAIN & FLUSH		
(G) ENGINE COOLANT	50% WATER 50% ETHYL GLYCOL	11 QUARTS		DRAIN & FLUSH EVERY 2 YRS.		
(H) PRIMARY AIR FILTER				SEE SERVICE INDICATOR	104-4260	
(I) SAFETY AIR FILTER				SEE OPERATOR'S MANUAL	104-4261	
(J) REAR AXLE	85W-140	80 OUNCES	800 HOURS		99-7591 BREATHER	
(K) PLANETARY DRIVE	85W-140	16 OUNCES	800 HOURS			
INTERLOCK SWITCHES				2 YEARS		

FUSE	SCH	START	OPTIONAL MAX (15A)	OPTIONAL MAX (15A)
	2A	10A		
	MAIN 15A START	PTO 10A 2WD/4WD	POWER POINT 10A	CONSOLE 10A

105-9895

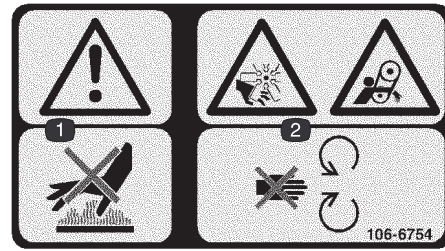

106-6754

1. Warning—do not touch the hot surface.
2. Cutting/dismemberment hazard, fan and entanglement hazard, belt—stay away from moving parts



105-9830
(Affix for CE)

1. Lock
2. Unlock



93-6686

1. Hydraulic oil
2. Read the *Operator's Manual*.

⚠ DANGER

ESTA MAQUINA PUEDE SER RIESGOSA SI SE USA EN UNA MANERA INAPROPIADA. OPERADORES DEBEN ESTAR MUY BIEN ENTRENADOS EN LA MANERA APROPRIADA DE OPERAR LA MAQUINA.

TO MINIMIZE THE RISK OF ACCIDENTS, INJURY, OR DEATH:

BEFORE LEAVING OPERATOR'S POSITION:

1. MOVE TRANSMISSION TO NEUTRAL
2. SET PARKING BRAKE
3. DISENGAGE POWER TAKE-OFF
4. SHUT OFF ENGINE
5. REMOVE IGNITION KEY

- KEEP ALL GUARDS AND SHIELDS IN PLACE AND WORKING.
- WAIT FOR ALL MOVEMENT TO STOP BEFORE SERVICING.
- STOP ENGINE BEFORE LEAVING SEAT, ADDING FUEL OR LIFTING HOOD.
- KEEP PEOPLE AND PETS A SAFE DISTANCE AWAY.
- ALWAYS USE SEAT BELT AND ROLL BAR TOGETHER AND HAVE SEAT PIVOT LATCHED.
- OPERATOR MUST BE SKILLED AND TRAINED.
- READ OPERATOR'S MANUAL.
- GO SLOW AND AVOID SHARP TURNS ON SLOPES TO AVOID ROLLOVER.
- DECK MUST BE LOWERED WHEN GOING DOWN SLOPES FOR STEERING CONTROL.

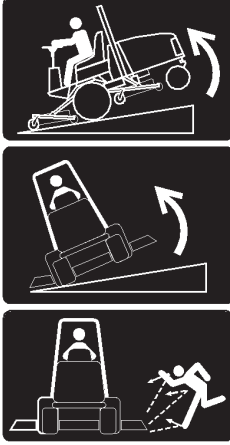

105-3889

105-3889

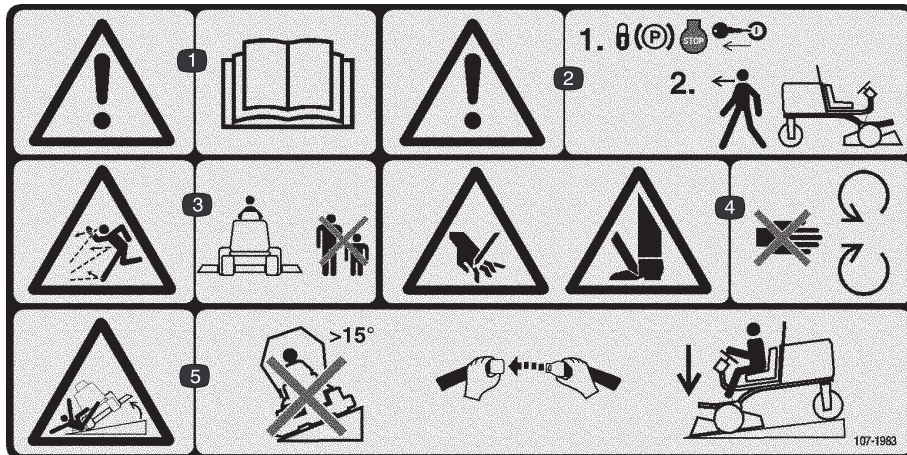

107-1983

107-1983
(Affix over part no. 105-3889 for CE)

1. Warning—read the *Operator's Manual*.
2. Warning—lock the parking brake, stop the engine, and remove the ignition key before leaving the machine.
3. Thrown object hazard—keep bystanders a safe distance from the machine.
4. Cutting hazard of hand or foot—stay away from moving parts.
5. Tipping hazard—do not drive the machine on a slope greater than 15 degrees, wear the seat belt, and lower the cutting unit when driving down slopes.

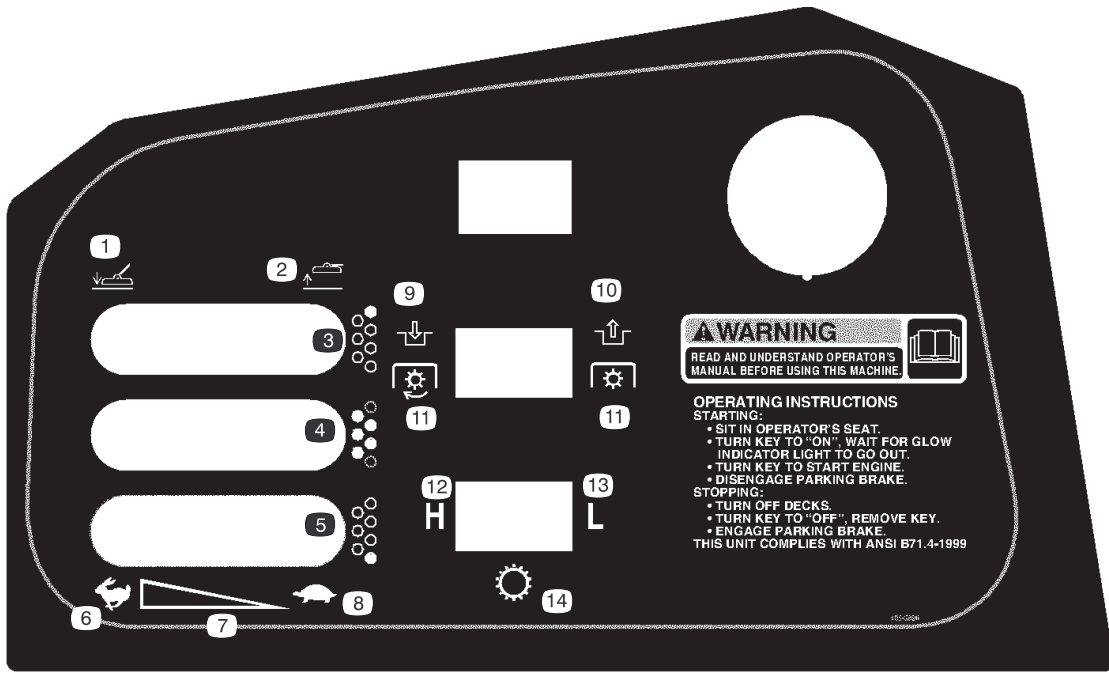

105-3890

- | | | | |
|---|--|--------------------------------|--------------------------|
| 1. Lower the cutting unit(s). | 4. Center cutting units | 7. Continuous variable setting | 11. Power Take-off (PTO) |
| 2. Raise the cutting unit(s). | 5. Left cutting unit
(GM 4700-D only) | 8. Slow | 12. High |
| 3. Right cutting unit
(GM 4700-D only) | 6. Fast | 9. Engage | 13. Low |
| | | 10. Disengage | 14. Transmission |

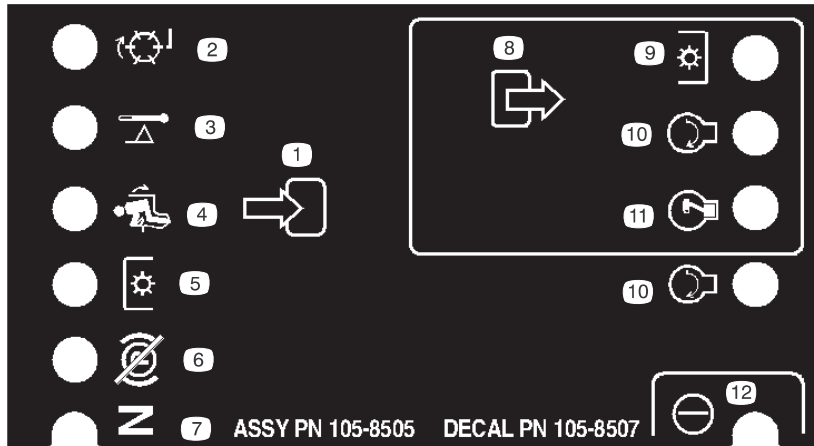

105-8507

- | | | | |
|--------------|-------------------|------------|-----------|
| 1. Input | 4. In seat | 7. Neutral | 10. Start |
| 2. Backlap | 5. PTO switch | 8. Output | 11. ETR |
| 3. High temp | 6. Park brake off | 9. PTO | 12. Power |

Specifications

Traction Unit Specifications

Engine	Kubota, four-cycle, four cylinder, 122 in. ³ displacement, water-cooled turbo diesel engine. Rated 58 hp @ 2600 RPM, 23:1 compression ratio. Low idle—1300 RPM, high idle—2800 RPM. Oil capacity is 8 qt. (7.6 l) with filter.
Cooling system	Capacity is 2-3/4 gallons (10.4 l) of 50/50 mixture of ethylene glycol anti-freeze.
Fuel system	Electric fuel pump. Replaceable inline filter and spin-on fuel filter/water separator. Capacity is 21 gallons (79.5 l) of #2 diesel fuel.
Hydraulic system	Reservoir capacity is 7.5 gallons (30 l). Two replaceable spin-on filter elements.
Traction system	Servo-controlled hydrostatic system driving planetary gear reduction front wheel drives. Foot pedal control of forward/reverse ground speed. Rear drive axle coupled to hydrostatic transmission for full time 4-wheel drive when in Mow position. A Roll Over Protective Structure (ROPS) and seat belt are standard.
Ground speed	Mow: 0–7 MPH (0–11.3 km/h) Transport: 0–13 MPH (0–21 km/h)
Tires	Front: 29x14.00–15, 6-ply, tubeless ultra-track tread Rear: 20x12.00–10, 6-ply, tubeless multi track tread Front and back tire pressure is 20 psi (138 kPa).
Diagnostic system	Test ports for traction system, cutting unit drive system, lift/counterbalance, lift/relief, steering circuits, and charge pressure are located near individual components.
Steering system	Automotive type, full power
Brakes	Internal multiple wet disc brakes
Electrical system	12 volt, 110 minute reserve capacity (DIN) battery and 40 amp. alternator. Negative ground.
Interlock system	Prevents engine from starting unless traction pedal is in neutral and PTO is disengaged. If the operator leaves seat with PTO engaged, after one second the PTO will disengage and the engine will stop. Engine will stop if machine comes out of neutral with parking brake set.
Gauges and indicator lights	Fuel gauge, engine coolant temperature gauge, hour meter, indicator lights for high engine coolant temperature, low engine oil pressure, glow plugs and charging.
Controls	Steering wheel, ignition switch, PTO switch, throttle control, traction pedal, mow/transport speed selector switch, brakes (for turning or traction assist), parking brake pedal lock, and cutting unit lift/lower levers



Note: Specifications subject to change without notice.

Measurements

Width of cut	150 in. (3.8 m)
Overall width	
cutting units down	153.8 in. (391 cm)
cutting units up (transport)	88.25 in. (224 cm)
Overall length	145.8 in. (370 cm)
Height with ROPS	85 in. (216 cm)
Ground clearance	6 in. (15 cm)
Track Width	
front	88.25 in. (224 cm)
rear	55.5 in. (141 cm)
Wheel base	67-1/2 in. (171 cm)
Weight (with cutting units and no fluids)	4674 lb. (2120 kg)

Optional Equipment

27" Rotary Cutting Unit	Model No. 30827
Deluxe Seat Kit (Seat suspension not included)	Model No. 30398
Seat Suspension Kit	Model No. 30395
Arm Rest Kit	Model No. 30707
Mulching Baffle Kit (one per cutting unit)	Model No. 30828
High Lift Parallel Sail Blade (one per cutting unit)	Part No. 105-4089

	Warning	
<p>Do not use the high lift blade with the mulching baffle. The blade could break, resulting in personal injury or death.</p>		

Setup

Note: Determine the left and right sides of the machine from the normal operating position.

Loose Parts

Note: Use this chart as a checklist to ensure that all parts necessary for assembly have been received. Without these parts, total setup cannot be completed. Some parts may have already been assembled at the factory.

Description	Qty.	Use
Seat belt	1	Installing the seat belt
Capscrew 7/16–20 x 1"	2	
Lock washer 7/16	2	
Manual tube	1	Installing the manual tube
R-clamp	2	
Parts catalog	1	
Pre-delivery inspection sheet	1	
Operator's manual	2	Read before operating the machine.
Engine manual	1	View before operating machine
Operator Video	1	
Registration card	1	
	1	

Installing the Seat, Seat Belt, and Manual Tube

The machine is shipped without the seat assembly. Deluxe Seat Kit, Model No. 30398, and Seat Suspension Kit, Model No. 30395, must be purchased and installed.

1. Mount the manual tube to the seat suspension with the 2 R-clamps included in loose parts.
2. Install the seat belt to each side of the seat with a bolt and lock washer, supplied in loose parts.

Important Make sure that the seat switch is connected to the seat switch connector on the harness.

3. Slide the seat completely forward and backward to ensure proper operation and that seat switch wires and connectors are not pinched or do no contact any moving parts.

Greasing the Machine

Before the machine is operated, it must be greased to ensure proper lubrication. Refer to Greasing the Bearings and Bushings section in the Operator's Manual. Failure to properly grease the machine will result in premature failure of critical parts.

Before Operating

⚠
Caution
⚠

If you leave the key in the ignition switch, someone could accidentally start the engine and seriously injure you or other bystanders.

Remove the key from the ignition before you do any maintenance.

Checking the Engine Oil

Check the oil level at the beginning of each day.

The crankcase capacity is 8 qt. (7.6 l) with the filter.

1. Park the machine on a level surface. Unlock the engine cover latches.
2. Open the engine cover.
3. Remove the dipstick, wipe it clean, install the dipstick into the tube, and pull it out again. The oil level should be up to the FULL mark (Fig. 1).

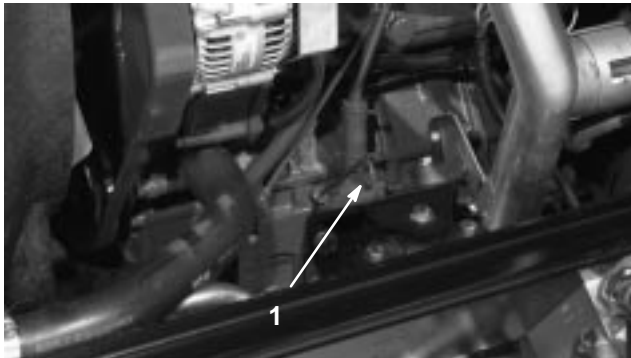

Figure 1

1. Dipstick

4. If the oil is below the FULL mark, remove the fill cap (Fig. 2) and add oil until the level reaches the FULL mark. **Do not overfill.**

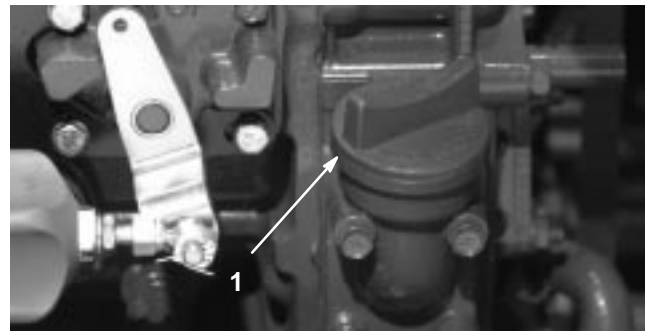

Figure 2

1. Oil fill cap

5. The engine uses any high-quality detergent oil having the American Petroleum Institute (API) “service classification” CD, CE, CF, CF-4, or CG-4. Use the following chart to select the proper viscosity grade for the temperature expected.

above 77°F (25°C)	SAE 30 or	10W-30 10W-40
32° to 77°F (0° to 25°C)	SAE 20 or	10W-30 10W-40
below 32°F (0°C)	SAE 10 or	10W-30 10W-40

Note: When using different oil, drain all old oil from the crankcase before adding new oil.

6. Install the oil fill cap and dipstick.
7. Close the engine cover and secure it with the latches.

Checking the Cooling System

Check level of coolant at the beginning of each day. Capacity of system is 2-3/4 gal. (10.4 l).

1. Carefully remove the radiator cap and expansion tank cap (Fig. 3).



Caution



If the engine has been running, the pressurized, hot coolant can escape and cause burns.

- Do not open the radiator cap when the engine is running.
- Use a rag when opening the radiator cap, and open the cap slowly to allow steam to escape.

2. Check the coolant level in the radiator. The radiator should be filled to the top of the filler neck and the expansion tank filled to the FULL mark.



Figure 3

1. Expansion tank

3. If the coolant is low, add a 50/50 mixture of water and ethylene glycol anti-freeze. **Do not use water only or alcohol/methanol base coolants.**
4. Install the radiator cap and expansion tank cap.

Filling the Fuel Tank

The capacity of the fuel tank is 21 gallons (79 l).

1. Remove the fuel tank cap (Fig. 4).



Figure 4

1. Fuel tank cap

2. Fill the tank to about 1 inch (25 mm) below the top of the tank, not the filler neck, with No. 2 diesel fuel. Then install the cap.



Danger



Under certain conditions, diesel fuel and fuel vapors are highly flammable and explosive. A fire or explosion from fuel can burn you and others and can cause property damage.

- Use a funnel and fill the fuel tank outdoors, in an open area, when the engine is off and is cold. Wipe up any fuel that spills.
- Do not fill the fuel tank completely full. Add fuel to the fuel tank until the level is 1/4 to 1/2 in. (6 to 13 mm) below the bottom of the filler neck. This empty space in the tank allows the fuel to expand.
- Never smoke when handling fuel, and stay away from an open flame or where fuel fumes may be ignited by a spark.
- Store fuel in a clean, safety-approved container and keep the cap in place.

Checking the Hydraulic Fluid

The machine's reservoir is filled at the factory with approximately 7.5 gallons of high quality hydraulic fluid. **Check the level of hydraulic fluid before the engine is first started and daily thereafter.** Appropriate hydraulic oils are listed below.

The following list is not assumed to be all-inclusive. Hydraulic fluids produced by other manufacturers may be used if they cross find a cross reference equivalent to the products listed. Toro will not assume responsibility for damage caused by improper substitutions, so use only products from reputable manufacturers who will stand behind their recommendation.

Multigrade Hydraulic Fluid – ISO VG 46

Normal Climate: 0 (-18 °C) to 110 °F (43 °C)

Mobil	DTE 15M
Amoco	Rykon Premium ISO 46
Chevron	Rykon Premium Oil ISO 46
Conoco	Hydroclear AW MV46
Exxon	Univis N46
Pennzoil	AWX MV46
Shell	Tellus T 46
Texaco	Rando HDZ 46

Important The ISO VG 46 Multigrade fluid has been found to offer optimal performance in a wide range of temperature conditions. For operation in consistently high ambient temperatures, 65 °F (18 °C) to 120 °F (49 °C), ISO VG 68 hydraulic fluid may offer improved performance.

Note: Many hydraulic fluids are almost colorless, making it difficult to spot leaks. A red dye additive for the hydraulic system oil is available in 2/3 oz. (20 ml) bottles. One bottle is sufficient for 4–6 gal (15–22 l) of hydraulic oil. Order part no. 44–2500 from your authorized Toro distributor. Not recommended for biodegradable fluid (use food coloring).

Biodegradable Hydraulic Fluid – Mobil 22411

Important Mobil EAL 224H is the only biodegradable oil tested and approved by Toro. Contamination by mineral-based hydraulic fluids will change the biodegradability and toxicity of this oil. When changing from standard fluid to the biodegradable type, be certain to follow the approved flushing procedure published by

Mobil. Contact your local Toro Distributor for details. This oil is available in 5 gallon (19 l) containers from your Toro Distributor, order part no. 100–7674.

1. Position the machine on a level surface, lower the cutting units, stop the engine, and remove the key.
2. Clean the area around the filler neck and cap of the hydraulic tank (Fig. 5). Remove the cap from the filler neck.

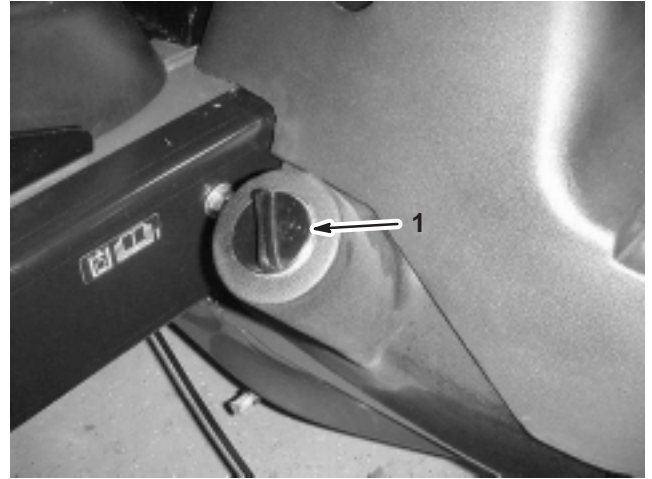

Figure 5

1. Hydraulic tank cap
3. Remove the dipstick from the filler neck and wipe it with a clean rag. Insert the dipstick into the filler neck; then remove it and check the fluid level. The fluid level should be between the two marks on the dipstick.
4. If the level is low, add the appropriate fluid to raise the level to the upper mark.
5. Install the dipstick and cap onto the filler neck.

Checking the Planetary Gear Drive Oil

Check the oil level after every 400 hours of operation or if external leakage is noted. Use high quality SAE 85W-140 wt. gear lube as a replacement.

The capacity of the system is approximately 16 oz. (0.5 l).

1. With the machine on a level surface, position the wheel so that the check/drain plug (Fig. 6) is at either the 2 or 10 o'clock position.

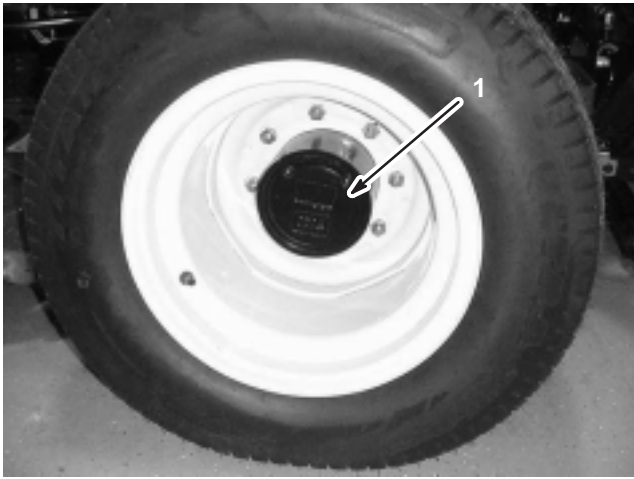

Figure 6

1. Check/drain plug
-
2. Remove the plug on the planetary (Fig. 6)). Oil should be at the bottom of the check plug hole.
 3. Add gear oil to the hole in the planetary, if necessary, to bring the oil up to the proper level. Install the plug.
 4. Repeat steps 1–3 on the opposite gear assembly.

Checking the Rear Axle Lubricant

The rear axle is shipped from the factory filled with SAE 85W-140 wt. gear lube. Check the oil level before the engine is first started and every 400 hours thereafter. The capacity is 80 oz. (2.4 l). Visually inspect for leaks daily.

1. Position the machine on a level surface.
2. Remove a check plug from one end of the axle (Fig. 7) and make sure that the lubricant is up to the bottom of the hole. If the level is low, remove the fill plug (Fig. 7) and add enough lubricant to bring the level up to the bottom of the check plug holes.

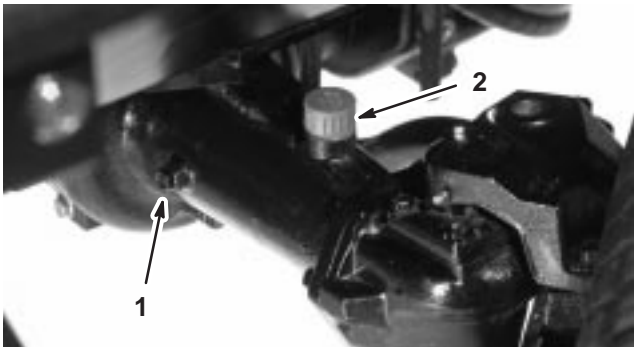

Figure 7

1. Check plug
2. Fill plug

Check Tire Pressure

The tires are over-inflated for shipping. Therefore, release some of the air to reduce the pressure. The correct air pressure in the tires is 20 psi (138 kPa).

Important Maintain the recommended pressure in all tires to ensure a good quality-of-cut and proper machine performance. **Do not under-inflate.**

Checking the Torque of the Wheel Nuts

! Warning !
<p>Failure to maintain proper torque of the wheel nuts could result in failure or loss of wheel and may result in personal injury.</p> <p>Torque the front and rear wheel nuts to 85–100 ft.-lb. (115–136 N·m) after 1–4 hours of operation and again after 10 hours of operation. Torque every 200 hours thereafter.</p>

Note: Front wheel nuts are 1/2–20 UNF. Rear wheel nuts are M12 x 1.6–6H (Metric).

Operation

Note: Determine the left and right sides of the machine from the normal operating position.

Caution

This machine produces sound levels in excess of 85 dBA at the operators ear and can cause hearing loss through extended periods of exposure.

Wear hearing protection when operating this machine.

Controls

Traction Pedal

The traction pedal (Fig. 8) controls forward and reverse operation. Depress the top of the pedal to move forward and the bottom to move backward. Ground speed depends on how far the pedal is depressed. For no load, maximum ground speed, fully depress the pedal while the throttle is in Fast.

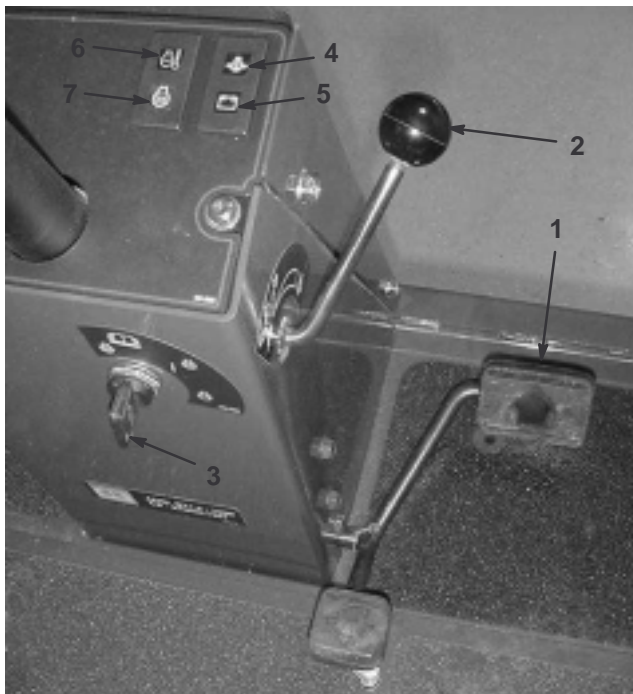

Figure 8

- | | |
|--------------------------------------|---|
| 1. Traction pedal | 5. Charge indicator |
| 2. Forward speed control | 6. Engine coolant temperature warning light |
| 3. Key switch | 7. Glow plug indicator light |
| 4. Engine oil pressure warning light | |

To stop, reduce your foot pressure on the traction pedal and allow it to return to the center position.

Forward Speed Control

Preset the forward speed control (Fig. 8) to limit the amount the traction pedal can be depressed in the forward direction to maintain a constant mowing speed.

Key Switch

The key switch (Fig. 8) has three positions: Off, On/Preheat, and Start.

Engine Oil Pressure Warning Light

The light (Fig. 8) illuminates when the engine oil pressure is dangerously low.

Charge Indicator

The charge indicator (Fig. 8) illuminates when the system charging circuit malfunctions.

Engine Coolant Temperature Warning Light

The light (Fig. 8) illuminates and the engine shuts down when coolant reaches an excessively high temperature.

Glow Plug Indicator Light

When lit, the glow plug indicator light (Fig. 8) indicates that the glow plugs are on.

Speed Limiter Screws

Adjust the screw(s) (Fig. 9) to limit the amount the traction pedal can be depressed in the forward or reverse direction to limit speed.

Important The speed limiter screw must stop the traction pedal before the pump reaches full stroke or damage to the pump may occur.

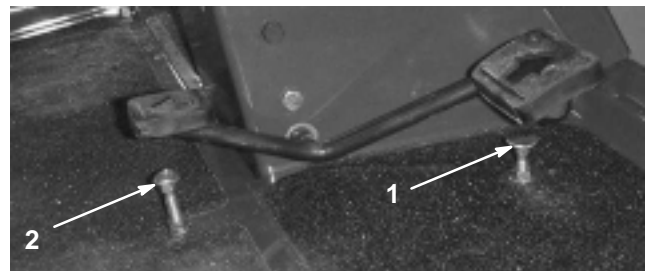

Figure 9

- | | |
|--------------------------------|--------------------------------|
| 1. Forward speed limiter screw | 2. Reverse speed limiter screw |
|--------------------------------|--------------------------------|

Brake Pedals

Two foot pedals (Fig. 10) operate individual wheel brakes for turning assistance, parking, and to aid in obtaining better side hill traction. A latch connects the pedals for parking brake operation and transport.

Pedal Locking Latch

The pedal locking latch (Fig. 10) connects the pedals together to engage the parking brake.

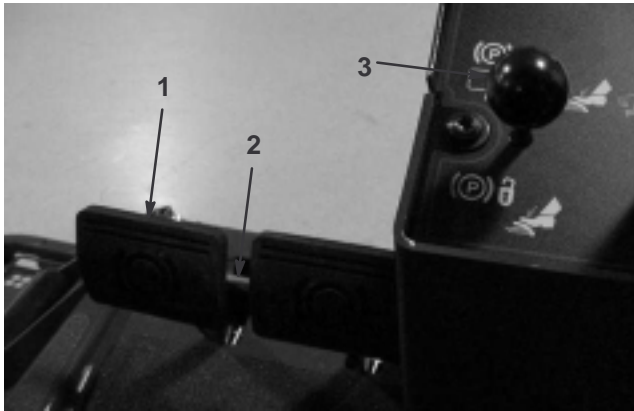

Figure 10

- 1. Brake pedals
- 2. Pedal locking latch
- 3. Parking brake latch

Parking Brake Latch

A knob on the left side of the console actuates the parking brake lock (Fig. 10). To engage the parking brake, connect the pedals with the locking latch, push down on both pedals, and pull the parking brake latch out. To release the parking brake, depress both pedals until the parking brake latch retracts.

Throttle Control

Move the control (Fig. 11) forward to increase the engine speed and rearward to decrease the speed.

Lift Lever

The lever (Fig. 11) raises and lowers the cutting units.

Hour Meter

The hour meter (Fig. 11) shows the total hours that the machine has been operated.

Engine Temperature Gauge

This gauge (Fig. 11) indicates the engine coolant temperature.

PTO Switch

The PTO switch (Fig. 11) has two positions: On (engage) and Off (disengage). Push the PTO switch forward to the On position to start the implement or cutting unit blades. Push the switch backward to the Off position to stop implement operation.

Hi-Lo Speed Control

The switch (Fig. 11) allows the speed range to increase for transport of the machine. Cutting decks will not operate in high range.

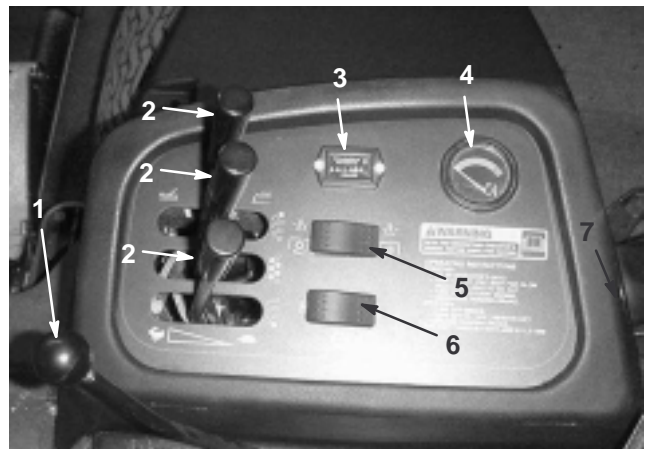

Figure 11

- 1. Throttle control
- 2. Lift levers
- 3. Hour meter
- 4. Engine temperature gauge
- 5. PTO switch
- 6. Hi-Lo speed control
- 7. Power point

Power Point

The power point (Fig. 11) is used to power optional 12 volt electrical accessories.

Fuel Gauge

The fuel gauge (Fig. 12) indicates the level of fuel in the tank.

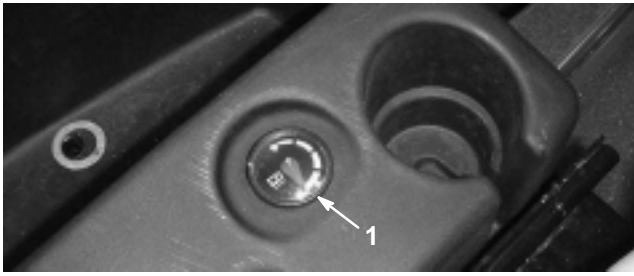

Figure 12

1. Fuel gauge

Cutting Unit Lift Latch (CE)

The cutting unit lift latch (Fig. 13) locks the center five cutting unit lift levers when the cutting units are in the raised position.



Figure 13

1. Cutting unit lift latch

Starting and Stopping the Engine

Important The fuel system must be bled if any of the following situations have occurred:

- The engine has ceased running due to lack of fuel.
- Maintenance has been performed upon the fuel system components.

Refer to Bleeding the Fuel System, page 21.

1. Remove your foot from the traction pedal and ensure that it is in neutral. Ensure that the parking brake is set.
2. Move the throttle control to the low idle position.
3. Turn the ignition key to the Run position. The glow indicator will light.
4. When the glow indicator dims, turn the ignition key to the Start position. Release the key immediately when the engine starts and allow it to return to the Run position. Move the throttle control to the desired position.

Important Do not run the starter motor more than 15 seconds at a time or premature starter failure may result. If the engine fails to start after 15 seconds, turn the key to the Off position, recheck the controls and procedures, wait 15 additional seconds, and repeat the starting procedure.

When the temperature is less than 20°F (-7°C), the starter motor can be run for 30 seconds on then 60 seconds off for 2 attempts.

5. When the engine is started for the first time, or after an overhaul of the engine, transmission, or axle, operate the machine in forward and reverse for one or two minutes. Also operate the lift lever and PTO lever to ensure proper operation of all parts. Turn the steering wheel to the left and right to check steering response. Then shut the engine off and check for oil leaks, loose parts, and any other noticeable difficulties.



Caution



Shut the engine off and wait for all moving parts to stop before checking for oil leaks, loose parts, and other malfunctions.

6. To stop the engine, move the throttle control backward to the Slow position, move the PTO lever to the Off position, set the parking brake, and rotate the ignition key to Off. Remove the key from the switch to prevent accidental starting.

Important Allow engine to idle for 5 minutes before shutting it off after a full load operation. This allows the turbo charger to cool before shutting off the engine. Failure to do so may lead to turbo-charger trouble.

Bleeding the Fuel System

1. Park the machine on a level surface. Make sure that the fuel tank is at least half full.
2. Unlatch and raise the hood.



Danger



Under certain conditions, diesel fuel and fuel vapors are highly flammable and explosive. A fire or explosion from fuel can burn you and others and can cause property damage.

- Use a funnel and fill the fuel tank outdoors, in an open area, when the engine is off and is cold. Wipe up any fuel that spills.
- Do not fill the fuel tank completely full. Add fuel to the fuel tank until the level is 1/4 to 1/2 in. (6 to 13 mm) below the bottom of the filler neck. This empty space in the tank allows the fuel to expand.
- Never smoke when handling fuel, and stay away from an open flame or where fuel fumes may be ignited by a spark.
- Store fuel in a clean, safety-approved container and keep the cap in place.

3. Open the air bleed screw on the fuel injection pump (Fig. 14).
4. Turn the key in the ignition switch to the On position. The electric fuel pump will begin operation, thereby forcing air out around the air bleed screw. Leave the key in the On position for 15 seconds. Air and fuel will be internally drained back to fuel tank. Tighten the screw and turn the key to Off.

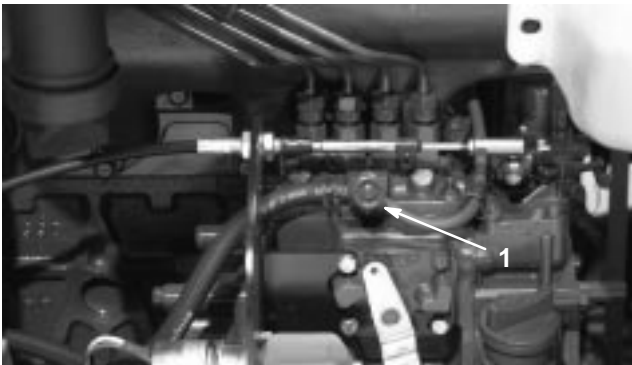

Figure 14

1. Fuel injection pump bleed screw

Note: Normally the engine should start after the above bleeding procedures are followed. However, if the engine does not start, air may be trapped between the injection pump and injectors; refer to Bleeding Air from the Injectors, page 35.

Checking the Interlock Switches



Caution



If safety interlock switches are disconnected or damaged the machine could operate unexpectedly causing personal injury.

- Do not tamper with the interlock switches.
- Check the operation of the interlock switches daily and replace any damaged switches before operating the machine.
- Replace switches every two years or 1500 hours, whichever occurs first, regardless of whether they are operating properly or not.

The machine has interlock switches in the electrical system. These switches are designed to stop the engine when operator gets off of the seat when the traction pedal is depressed. However, the operator may get off of the seat while the engine is running and the traction pedal is in neutral. Although the engine will continue to run if the PTO lever is disengaged and the traction pedal is released, it is strongly recommended that the engine be stopped before rising from the seat.

To check the operation of the interlock switches, perform the following procedure:

1. Drive the machine slowly to a large, relatively open area. Lower the cutting unit, stop the engine, and apply the parking brake.
2. Sit on the seat and depress the traction pedal. Try to start the engine. The engine should not crank. If the engine cranks, there is a malfunction in the interlock system that should be corrected before beginning operation.
3. Sit on the seat and start the engine. Rise from the seat and move the PTO lever to On. The PTO should not engage. If the PTO engages, there is a malfunction in the interlock system that should be corrected before beginning operation.
4. Sit on the seat, engage the parking brake and start the engine. Move the traction pedal out of the neutral position. The engine should kill. If the engine does not kill, there is a malfunction in the interlock system that should be corrected before beginning operation.

Pushing or Towing the Machine

In an emergency, the machine can be moved forward by actuating the bypass valve in the variable displacement hydraulic pump and pushing or towing the machine. **Do not push or tow the machine for more than 1/4 mile (0.4 km).**

Important Do not push or tow the machine faster than 2–3 MPH (3–4.8 km/h) because internal transmission damage may occur. The bypass valve must be open whenever the machine is pushed or towed.

Important If the machine must be pushed or towed in reverse, the check valve in the four-wheel drive manifold must also be bypassed. To bypass the check valve, connect a hose assembly (Hose Part No. 95-8843, Coupler Fitting No. 95-0985 [Qty. 2], and Hydraulic Fitting No. 340-77 [Qty. 2]) to the reverse traction pressure test port and the reverse four-wheel drive pressure port.

1. Open hood and remove the center shroud
2. Rotate the valve 90° (1/4 turn) in either direction to open and allow oil to bypass internally. Because fluid is bypassed, the machine can be slowly moved without damaging the transmission. Note the position of the valve when opening or closing.

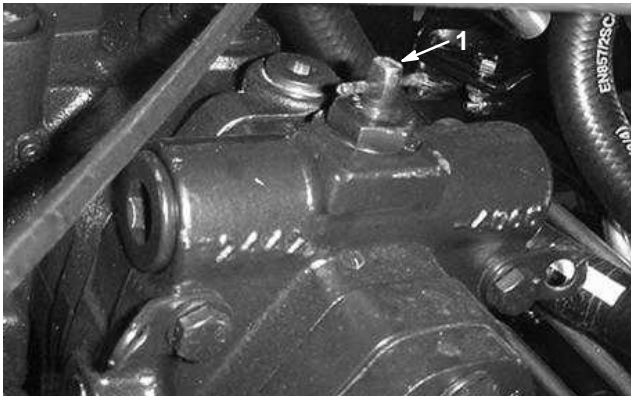

Figure 15

1. Bypass valve
-
3. Close the bypass valve before starting the engine. However, do not exceed 5–8 ft.-lb. (7–11 N·m) torque to close the valve.

Jacking Points

- On the front of the machine on the frame on the inside of each drive tire
- On the rear of the machine at the center of the axle

Tie Downs

- On each side of the frame under the front steps
- The rear bumper

Operating Characteristics

Practice driving the machine because it has a hydrostatic transmission and its characteristics are different than many turf maintenance machines. Some points to consider when operating the traction unit, cutting units, or other implements are the transmission, engine speed, load on the cutting blades or other implement components, and the importance of the brakes.

To maintain enough power for the traction unit and implement while operating, regulate the traction pedal to keep the engine RPM high and somewhat constant. A good rule to follow is to decrease the ground speed as the load on the implement increases, and increase the ground speed as the load decreases.

Therefore, allow the traction pedal to move backward as the engine RPM decreases, and depress the pedal slowly as the RPM increases. By comparison, when driving from one work area to another, with no load and cutting unit raised, have the throttle in the Fast position and depress the traction pedal slowly but fully to attain maximum ground speed.

Another characteristic to consider is the operation of the pedals that are connected to the brakes. The brakes can be used to assist in turning the machine. However, use them carefully, especially on soft or wet grass because the turf may be torn accidentally. Another benefit of the brakes is to maintain traction. For example, in some slope conditions, the uphill wheel slips and loses traction. If this situation occurs, depress the uphill turn pedal gradually and intermittently until the uphill wheel stops slipping, thus, increasing traction on the downhill wheel.

Use extra care when operating the machine on slopes. Make sure that the seat latch is properly secured and the seat belt is buckled. Drive slowly and avoid sharp turns on slopes to prevent roll overs. For steering control, the cutting cutting unit must be lowered when going downhill.



Warning



This product is designed to drive objects into the ground where they lose energy quickly in grass areas. However, careless operation, combined with terrain angle, ricochets, or improperly positioned safety guard can lead to thrown object injuries.

- When a person or pet appears suddenly in or near the mowing area, *stop mowing*.
- Do not resume mowing until the area is cleared.

Important Allow engine to idle for 5 minutes before shutting it off after a full load operation. Failure to do so may lead to turbo-charger trouble.

Before stopping the engine, disengage all controls and move the throttle to Slow. Moving the throttle to Slow reduces high engine RPM, noise, and vibration. Turn the key to Off to stop the engine.

Operating Tips

Mow When Grass is Dry

Mow either in the late morning to avoid the dew, which causes grass clumping, or in late afternoon to avoid the damage that can be caused by direct sunlight on the sensitive, freshly mowed grass.

Select the Proper Height-of-Cut Setting to Suit Conditions

Remove approximately 1 in. (25 mm) or no more than 1/3 of the grass blade when cutting. In exceptionally lush and dense grass, you may have to raise the height-of-cut to the next setting.

Mow at Proper Intervals

Under most normal conditions you will need to mow approximately every 4–5 days. But remember, grass grows at different rates at different times. This means that in order to maintain the same height-of-cut, which is a good practice, you will need to cut more frequently in early spring; as the grass growth rate slows in mid summer, cut only every 8–10 days. If you are unable to mow for an extended period due to weather conditions or other reasons, mow first with the height-of-cut at a high level; then mow again 2–3 days later with a lower height setting.

Blade Selection

Standard Angled Sail

The blade generally performs best in lower heights of cut (3/4 to 2–1/2 inch). The optional high lift parallel sail blade performs better in the higher heights of cut (2 to 4 inch).

Attributes:

- Discharge remains more even at lower heights of cut.
- Discharge has less tendency to throw left and thus a cleaner look around bunkers and fairways.
- Lower power requirement at lower heights and dense turf.

High Lift Parallel Sail

The blade generally performs better in the higher heights of cut (2 to 4 inch).

Attributes:

- More lift and higher discharge velocity.
- Sparse or limp turf is picked up significantly at higher heights of cut.
- Wet or sticky clippings are discharged more efficiently reducing congestion in deck.
- Requires more horsepower to run.
- Tends to discharge further left and can tend to windrow at lower heights of cut.



Warning



Do not use the high lift blade with the mulching baffle. The blade could break, resulting in personal injury or death.

Always Mow with Sharp Blades

A sharp blade cuts cleanly and without tearing or shredding the grass blades like a dull blade. Tearing and shredding causes the grass to turn brown at the edges which impairs growth and increases susceptibility to diseases.

Transporting

Use the transport latches when transporting over long distances, rough terrain, or when trailering.

After Operating

To ensure optimum performance, clean the underside of the mower housing after each use. If residue is allowed to build up in the mower housing, cutting performance will decrease.

Note: Lower cutting units to the ground whenever machine is parked. This relieves the hydraulic load from the system, prevents wear on system parts and also prevents accidental lowering of the cutting units.

Cutting Unit Pitch

We recommend a blade pitch of 5/16 in. (7.9 mm). A pitch larger than 5/16 in. (7.9 mm) will result in less power required, larger clippings, and a poorer quality of cut. A pitch less than 5/16 in. (7.9 mm) will result in more power required, smaller clippings and a better quality of cut.

Optional Equipment Configuration					
Application		Standard Angle Sail Blade	High Lift Parallel Sail Blade DO NOT USE WITH MULCHING BAFFLE	Mulching Baffle	Roller Scraper
	Grass Cutting: .75 to 1.75 inch Height of Cut	Recommended in most applications	May work well in light or sparse turf	Has been shown to improve dispersion and after cut performance on northern grasses that are cut at least three times per week and less than 1/3 of the grass blade is removed. DO NOT USE WITH THE HIGH LIFT PARALLEL SAIL BLADE	Can be used any time that rollers build up with grass or large flat grass clumps of grass are seen. The scrapers may actually increase clumping in certain applications.
	Grass Cutting: 2.00 to 2.50 inch Height of Cut	Recommended for thick or lush turf	Recommended for light or sparse turf		
	Grass Cutting: 2.75 to 4.00 inch Height of Cut	May work well in lush turf	Recommended in most applications		
	Leaf Mulching	Recommended for use with the mulching baffle	NOT ALLOWED	Use with standard angle sail blade only	
Pros	Even discharge at lower height of cut Cleaner look around bunkers and fairways Lower power requirements	More lift and higher discharge velocity Sparse or limp turf is picked up at high height of cut Wet or sticky clippings are discharged efficiently	May improve dispersion and appearance in certain grass cutting applications Very good for leaf mulching	Reduces roller buildup in certain applications	
Cons	Does not lift the grass well in high height of cut applications Wet or sticky grass has a tendency to build up in the chamber, leading to poor quality of cut and higher power requirement	Requires more power to run in some applications Tends to windrow at lower height of cut in lush grass DO NOT USE WITH MULCHING BAFFLE	Grass will build up in the chamber if attempting to remove too much grass with baffle in place		

Standard Control Module (SCM)

The Standard Control Module is a "potted" electronic device produced in a "one size fits all" configuration. The module uses solid state and mechanical components to monitor and control standard electrical features required for safe product operation.

The module monitors inputs including neutral, parking brake, PTO, start, backlap, and high temperature. The module energizes outputs including PTO, Starter, and ETR (energize to run) solenoid.

The module is divided into inputs and outputs. Inputs and outputs are identified by green LED indicators mounted on the printed circuit board.

The start circuit input is energized by 12 VDC. All other inputs are energized when the circuit is closed to ground. Each input has a LED that is illuminated when the specific circuit is energized. Use the input LED's for switch and input circuit troubleshooting.

Output circuits are energized by an appropriate set of input conditions. The three outputs include PTO, ETR, and START. Output LED's monitor relay condition indicating the presence of voltage at one of three specific output terminals.

Output circuits do not determine output device integrity so electrical troubleshooting includes output LED inspection and conventional device and wire harness integrity testing. Measure disconnected component impedance, impedance through wire harness (disconnect at SCM), or by temporarily "test energizing" the specific component.

The SCM does not connect to an external computer or hand held device, can not be re-programmed, and does not record intermittent fault troubleshooting data.

The decal on the SCM only includes symbols. Three LED output symbols are shown in the output box. All other LED's are inputs. The chart below identifies the symbols.

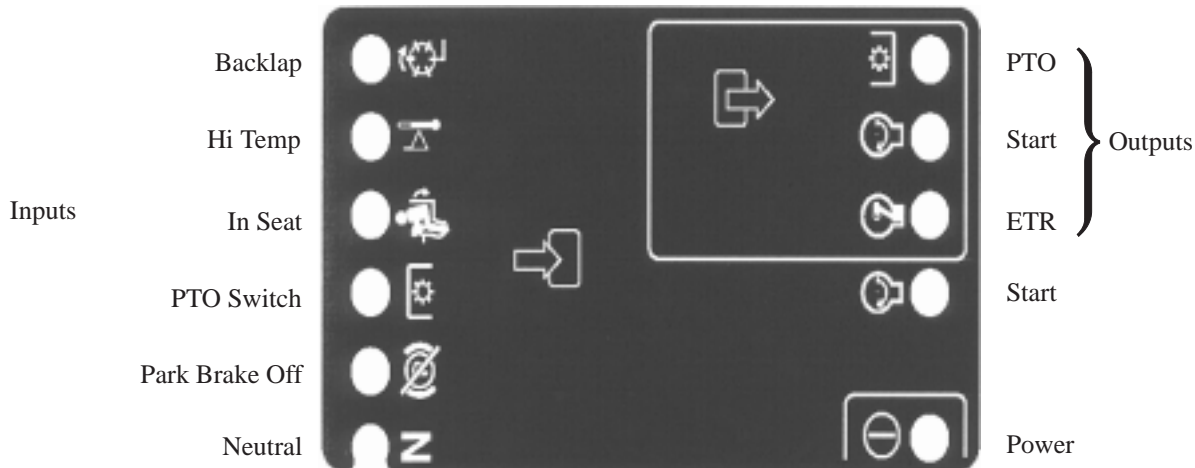

Here are the logical troubleshooting steps for the SCM device.

1. Determine the output fault you are trying to resolve (PTO, START, or ETR).
2. Move key switch to "ON" and ensure the red "power" LED is illuminated.
3. Move all input switches to ensure all LED's change state.
4. Position input devices at appropriate position to achieve the appropriate output. Use the following logic chart to determine the appropriate input condition.
5. If specific output LED is illuminated without appropriate output function, check output harness, connections, and component. Repair as required.
6. If specific output LED is not illuminated, check both fuses.
7. If specific output LED is not illuminated and inputs are in appropriate condition, install new SCM and determine if fault disappears.

Each row (across) in the logic chart below identifies input and output requirements for each specific product function. Product functions are listed in the left column. Symbols identify specific circuit condition including: energized to voltage, closed to ground, and open to ground.

FUNCTION	I N P U T S								O U T P U T S		
	Power On	In Neutral	Start On	Brake Off	PTO On	In Seat	Hi Temp	Back Lap	START	ETR	PTO
Start	-	-	+	O	O	-	O	O	+	+	O
Run (off unit)	-	-	O	O	O	O	O	O	O	+	O
Run (on unit)	-	O	O	-	O	-	O	O	O	+	O
Mow	-	O	O	-	-	-	O	O	O	+	+
Hi-Temp	-		O				-		O	O	O

- Indicates a circuit closed to ground. - LED ON

O Indicates a circuit open to ground or de-energized - LED OFF

+ Indicates an energized circuit (clutch coil, solenoid, or start input) LED ON.

” ” A Blank indicates a circuit that is not involved with the logic.

To troubleshoot, turn on the key without starting the engine. Identify the specific function that does not work and work across the logic chart. Inspect the condition of each input LED's to ensure it matches the logic chart.

If the input LED's are correct, check the output LED. If the output LED is illuminated but the device is not energized, measure available voltage at the output device, continuity of the disconnected device, and potential voltage on the ground circuit (floating ground). Repairs will vary depending on your findings.

Maintenance

Note: Determine the left and right sides of the machine from the normal operating position.

Recommended Maintenance Schedule

Maintenance Service Interval	Maintenance Procedure
After first 10 hours	<ul style="list-style-type: none"> • Check the alternator belt tension. • Torque the wheel lug nuts.
After first 50 hours	<ul style="list-style-type: none"> • Change the engine oil and filter. • Check the engine RPM (at idle and full throttle).
Every 50 hours	<ul style="list-style-type: none"> • Lubricate all grease fittings. • Inspect the air cleaner indicator.¹ • Check the battery level and cable connections.
Every 100 hours	<ul style="list-style-type: none"> • Change the engine oil and filter. • Inspect the cooling system hoses. • Check the alternator belt tension.
After first 200 hours	<ul style="list-style-type: none"> • Change the hydraulic oil. • Change the hydraulic oil filters. • Change the front planetary gear lube. • Change the rear axle oil.
Every 200 hours	<ul style="list-style-type: none"> • Torque the wheel lug nuts. • Service the spark arrestor.
Every 400 hours	<ul style="list-style-type: none"> • Service the air filter.¹ • Change the fuel filters (fuel/water and prefilter) • Inspect the fuel lines and connections. • Check the engine RPM (at idle and full throttle) • Check the rear axle oil level. • Check the front planetary gear lube.
Every 800 hours or annually, whichever occurs first	<ul style="list-style-type: none"> • Drain and clean the fuel tank. • Change the hydraulic oil. • Change the hydraulic oil filters. • Change the front planetary gear lube. • Change the rear axle oil. • Inspect, disassemble and install new seals in the cutting unit roller assemblies. • Check the rear wheel toe-in. • Check and adjust the valve clearance. • Replace the hydraulic tank breather
Every 1500 hours or 2 years, whichever occurs first	<ul style="list-style-type: none"> • Replace moving hoses. • Replace safety switches. • Flush the cooling system and replace fluid.

¹If the indicator shows red

Important Refer to your engine operator's manual and cutting unit operator's manual for additional maintenance procedures.

Daily Maintenance Checklist

Duplicate this page for routine use.

Maintenance Check Item	For the week of:						
	Mon.	Tues.	Wed.	Thurs.	Fri.	Sat.	Sun.
Check the safety interlock operation.							
Check the brake operation.							
Check the engine oil and fuel level.							
Check the cooling system fluid level.							
Drain the water/fuel separator.							
Check the air filter restriction indicator.							
Check the radiator, oil cooler, and screen for debris.							
Check unusual engine noises. ¹							
Check unusual operating noises.							
Check the hydraulic system oil level.							
Check hydraulic hoses for damage.							
Check for fluid leaks.							
Check the tire pressure.							
Check the instrument operation.							
Lubricate all grease fittings. ²							
Touch-up damaged paint.							

¹Check the glow plug and injector nozzles if hard starting, excess smoke, or rough running is noted.

²immediately **after every** washing, regardless of the interval listed

Notation for Areas of Concern

Inspection performed by:		
Item	Date	Information
1		
2		
3		
4		
5		
6		
7		
8		
9		
10		
11		
12		

Service Interval Chart

GROUNDMASTER 4500/4700 QUICK REFERENCE AID

CHECK/SERVICE (DAILY)

1. ENGINE OIL LEVEL
2. HYDRAULIC OIL FLUID LEVEL
3. ENGINE COOLANT LEVEL
4. FUEL - DIESEL ONLY
5. FUEL/WATER SEPARATOR
6. RADIATOR SCREEN
7. AIR CLEANER
8. BRAKE FUNCTION
9. TIRE PRESSURE: 20 PSI / 1.40 BAR
- WHEEL NUT TORQUE: 93 FT/LB (127 Nm)

**CHECK/SERVICE
(SEE OPERATOR'S MANUAL)**

10. BATTERY
11. BELTS (FAN, ALT.)
12. PLANETARY GEAR DRIVE
13. INTERLOCK SYSTEM
14. REAR AXLE
15. ENGINE OIL DRAIN
(13/16" OR 21 MM SOCKET)
16. GREASING (SEE OPERATOR'S MANUAL)

SPECIFICATIONS/CHANGE INTERVALS

SEE OPERATOR'S MANUAL FOR INITIAL CHANGES.	FLUID TYPE	CAPACITY	CHANGE INTERVAL		FILTER PART NO.	
			FLUID	FILTER		
(A) ENGINE OIL	10W-30 CE	8 QUARTS	100 HOURS	100 HOURS	98-7431	
(B) HYDRAULIC FLUID	ISO VG 46/68	7.5 GALLONS	800 HOURS	800 HOURS	75-1310	
(C) HYDRAULIC FILTER				800 HOURS	94-2621	
(D) HYDRAULIC BREATHER				800 HRS/YRLY	68-6150	
(E) FILTER, IN-LINE FUEL				400 HOURS	98-7612	
(F) FUEL SYSTEM	> 32 F	NO. 2 DIESEL	21 GALLONS	800 HOURS DRAIN/FLUSH	400 HOURS/ YEARLY	98-9764
	< 32 F	NO. 1 DIESEL				
(G) ENGINE COOLANT	50% WATER 50% ETHYL GLYCOL	11 QUARTS	DRAIN & FLUSH EVERY 2 YRS.			
(H) PRIMARY AIR FILTER				SEE SERVICE INDICATOR	104-4260	
(I) SAFETY AIR FILTER				SEE OPERATOR'S MANUAL	104-4261	
(J) REAR AXLE	85W-140	80 OUNCES	800 HOURS		99-7591 BREATHER	
(K) PLANETARY DRIVE	85W-140	16 OUNCES	800 HOURS			
INTERLOCK SWITCHES				2 YEARS		

FUSE	SCH 2A	START 10A	OPTIONAL MAX (15A)	OPTIONAL MAX (15A)
	MAIN 15A START	PTO 10A (2W/4WD)	POWER POINT 10A	CONSOLES 10A

105-9695

Caution

If you leave the key in the ignition switch, someone could accidentally start the engine and seriously injure you or other bystanders.

Remove the key from the ignition before you do any maintenance.

Greasing the Bearings and Bushings

The machine has grease fittings that must be lubricated regularly with No. 2 General Purpose Lithium Base Grease. If the machine is operated under normal conditions, lubricate all bearings and bushings after every 50 hours of operation or immediately after every washing.

The grease fitting locations and quantities are:

Traction Unit

- Brake shaft pivot bearings (5) (Fig. 16)
- Rear axle pivot bushings (2) (Fig. 17)
- Steering cylinder ball joints (2) (Fig. 18)
- Tie rod ball joints (2) (Fig. 18)
- King pin bushings (2) (Fig. 18). **The top fitting on the king pin should only be lubricated annually (2 pumps).**
- Lift arm bushings (1 per deck) (Fig. 19)
- Lift cylinder bushings (2 per deck) (Fig. 19)
- Cutting unit spindle shaft bearings (1 per cutting unit) (Fig. 20)
- Cutting unit carrier arm bushings (1 per cutting unit) (Fig. 20)

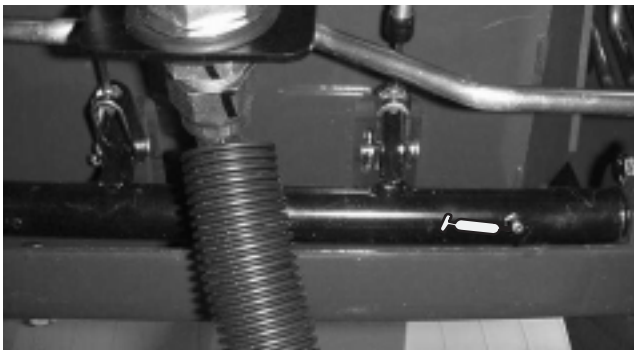

Figure 16

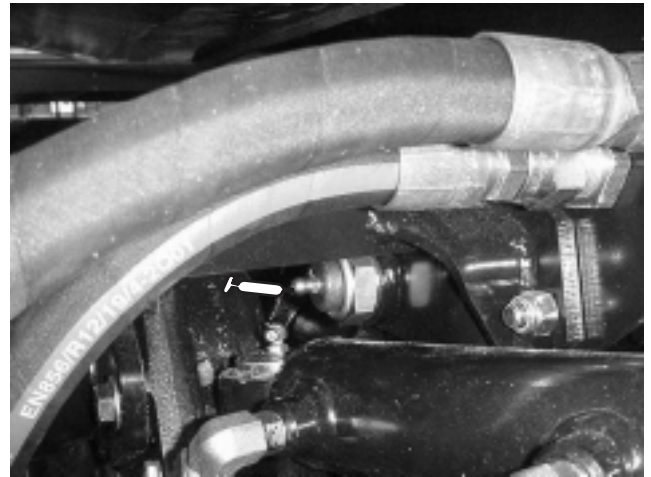

Figure 17



Figure 18

1. Top fitting on king pin

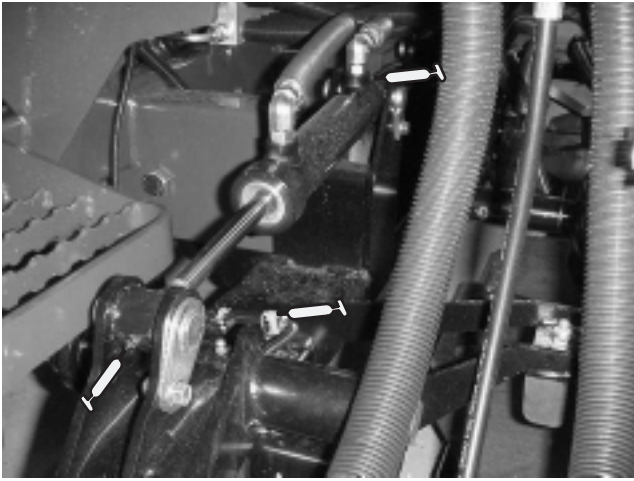

Figure 19

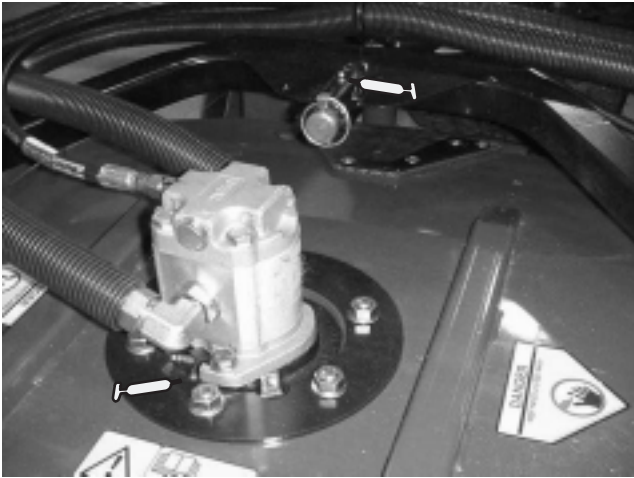

Figure 20

Hood Removal

To gain additional access to engine compartment, the hood may be removed from traction unit.

1. Release hood latches (Fig. 21) and raise hood.



Figure 21

1. Hood latch

2. Unhook lanyard from hood pin, remove pin and slide hood tubes rearward off guides (Fig. 22).



Figure 22

1. Hood pin

Servicing the Air Cleaner

Check the air cleaner body for damage which could possibly cause an air leak. Replace a damaged air cleaner body.

Service the air cleaner filters when the air cleaner indicator (Fig. 24) shows red or every 400 hours (more frequently in extremely dusty or dirty conditions). Do not over-service the air filter.



Figure 23

1. Air cleaner indicator

Be sure that the cover is sealing around the air cleaner body.

1. Pull the latch outward and rotate the air cleaner cover counterclockwise. Remove the cover from the body (Fig. 24). Clean the inside of the air cleaner cover.

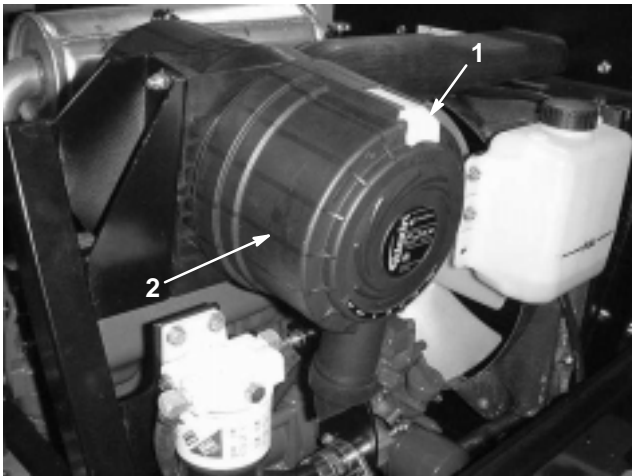

Figure 24

1. Air cleaner latch
2. Air cleaner cover

2. Gently slide the primary filter (Fig. 25) out of the air cleaner body to reduce the amount of dust dislodged. Avoid knocking the filter against the air cleaner body. **Do not** remove the safety filter (Fig. 26).

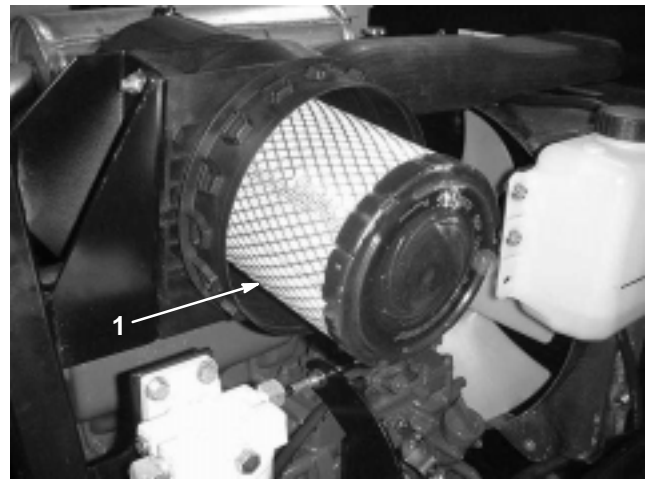

Figure 25

1. Air cleaner primary filter

3. Inspect the primary filter and discard it if it is damaged. Do not wash or reuse a damaged filter.

Important Never attempt to clean the safety filter (Fig. 26). Replace the safety filter with a new one after every three primary filter services.

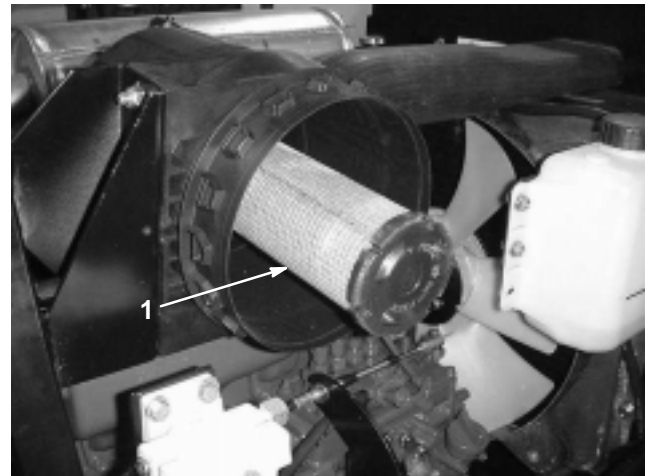

Figure 26

1. Air cleaner safety filter

4. Cleaning the air filter:

- A. Blow compressed air from the inside to the outside of the dry filter element. To prevent damage to the element, do not exceed 100 psi (689 kPa).
- B. Keep the air hose nozzle at least 2 in. (51 mm) from the filter and move the nozzle up and down while rotating the filter element. Inspect the filter for holes and tears by looking through it toward a bright light.

5. Inspect the new filter for shipping damage. Check the sealing end of the filter. Do not install a damaged filter.
6. Insert the new filter properly into the air cleaner body. Make sure that the filter is sealed properly by applying pressure to the outer rim of the filter when installing it. Do not press on the flexible center of the filter.
7. Install the cover and secure the latch. Make sure that the cover is positioned with the TOP side up.
8. Reset the indicator (Fig. 24) if it shows red.

Servicing the Engine Oil and Filter

Change the oil and filter initially after the first 50 hours of operation; thereafter change the oil and filter every 100 hours.

1. Remove the rear drain plug (Fig. 27) and let the oil flow into a drain pan. When the oil stops, install the drain plug.

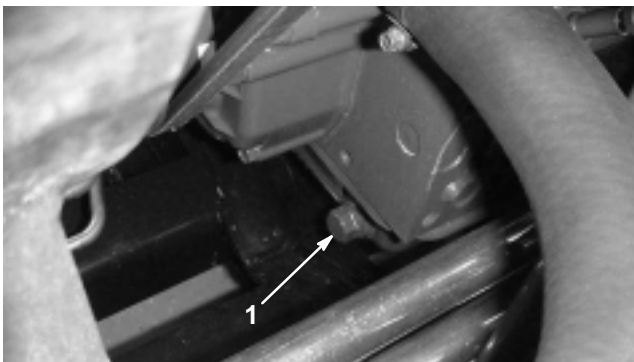

Figure 27

1. Engine oil drain plug
-
2. Remove the oil filter (Fig. 28). Apply a light coat of clean oil to the new filter seal before screwing it on. **Do not overtighten.**

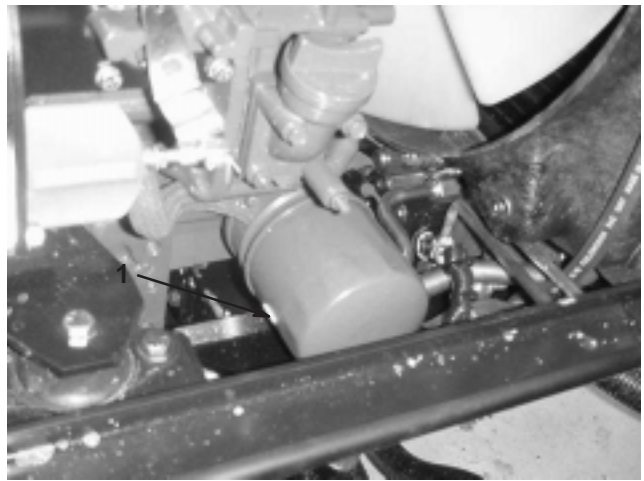

Figure 28

1. Engine oil filter
-
3. Add oil to the crankcase; refer to Checking the Engine Oil, page 15.

Servicing the Fuel System



Danger



Under certain conditions, diesel fuel and fuel vapors are highly flammable and explosive. A fire or explosion from fuel can burn you and others and can cause property damage.

- Use a funnel and fill the fuel tank outdoors, in an open area, when the engine is off and is cold. Wipe up any fuel that spills.
- Do not fill the fuel tank completely full. Add fuel to the fuel tank until the level is 1/4 to 1/2 in. (6 to 13 mm) below the bottom of the filler neck. This empty space in the tank allows the fuel to expand.
- Never smoke when handling fuel, and stay away from an open flame or where fuel fumes may be ignited by a spark.
- Store fuel in a clean, safety-approved container and keep the cap in place.

Fuel Tank

Drain and clean the fuel tank every 800 hours. Also, drain and clean the tank if fuel system becomes contaminated or if the machine will be stored for an extended period of time. Use clean fuel to flush out the tank.

Fuel Lines and Connections

Check the fuel lines and connections every 400 hours or yearly, whichever comes first. Inspect them for deterioration, damage, or loose connections.

Water Separator

Drain water or other contaminants from the water separator (Fig. 29) daily.

1. Place a clean container under the fuel filter.
2. Loosen the drain plug on the bottom of the filter canister (Fig. 29). Tighten the plug after draining.

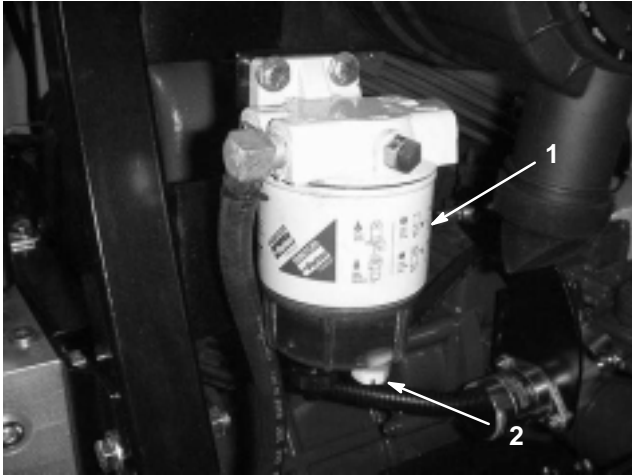

Figure 29

1. Water Separator
2. Drain plug

Replace filter canister after every 400 hours of operation.

- A. Clean the area where the filter canister mounts.
- B. Remove the filter canister and clean the mounting surface.
- C. Lubricate the gasket on the filter canister with clean oil.
- D. Install the filter canister by hand until the gasket contacts the mounting surface; then rotate it an additional 1/2 turn.

Replacing the Fuel Pre-Filter

Replace the fuel pre-filter (Fig. 30), located between fuel the tank and fuel pump, after every 400 operating hours or yearly, whichever occurs first.

1. Clamp both fuel lines that connect to the fuel filter so that fuel cannot drain when the lines are removed.

2. Loosen the hose clamps at both ends of the filter and pull the fuel lines off of the filter.

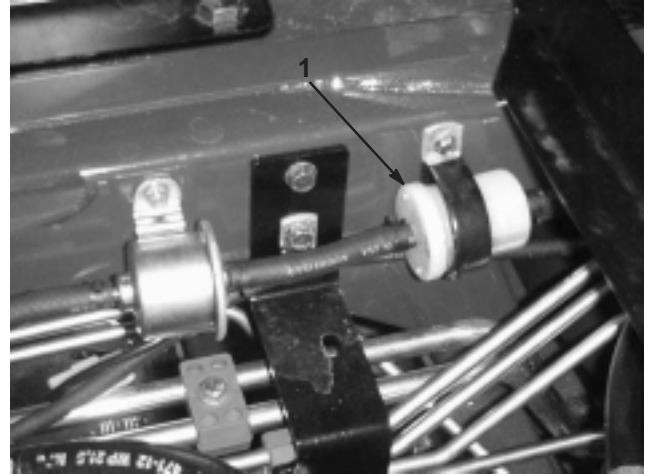

Figure 30

1. Fuel pre-filter

3. Slide the hose clamps onto the ends of the fuel lines. Push the fuel lines onto the fuel filter and secure them with the hose clamps. Be sure that the arrow on the side of the filter points toward the injection pump.

Bleeding Air from the Injectors

Note: This procedure should be used only if the fuel system has been purged of air through normal priming procedures and the engine will not start; refer to Bleeding the Fuel System, page 21.

1. Loosen the pipe connection to the No. 1 injector nozzle and holder assembly at the injection pump (Fig. 31).

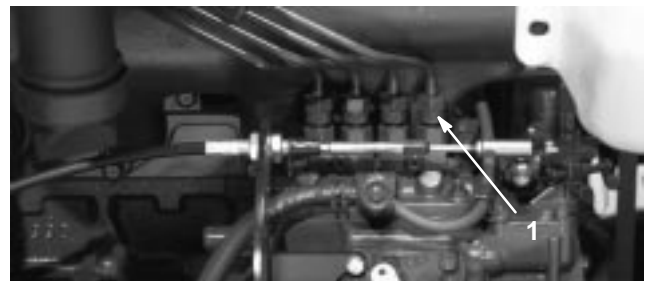

Figure 31

1. No. 1 injector nozzle

2. Move the throttle to the Fast position.
3. Turn the key in the ignition switch to the Start position and watch the fuel flow around the connector. Turn the key to the Off position when solid flow is observed.
4. Tighten the pipe connector securely.

- Repeat the procedure on the remaining nozzles.

Servicing the Engine Cooling System

Remove debris from the engine area, oil cooler and radiator daily. Clean them more frequently in dirty conditions.

- Unlatch and swing open rear screen (Fig. 32). Clean the screen thoroughly of all debris.

Note: To remove screen, lift off hinge pins.

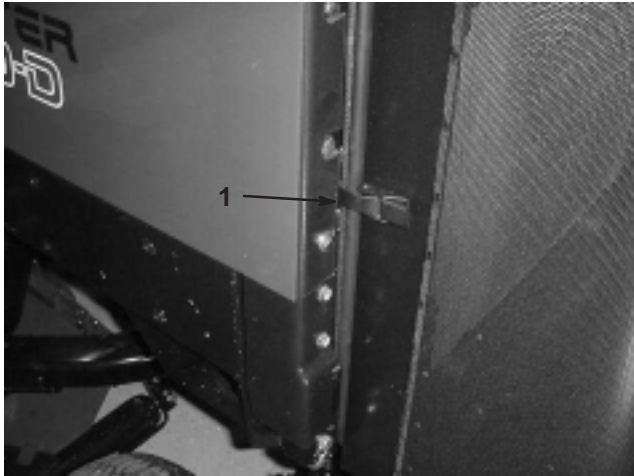

Figure 32

- Rear screen latch

- Rotate latches (Fig. 33) securing the oil cooler to the frame.

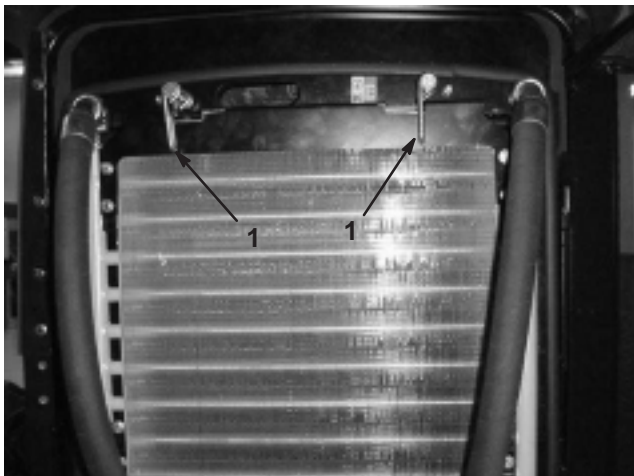

Figure 33

- Oil cooler latches

- Pivot the oil cooler rearward. Clean both sides of the oil cooler and radiator area (Fig. 34) thoroughly with compressed air.

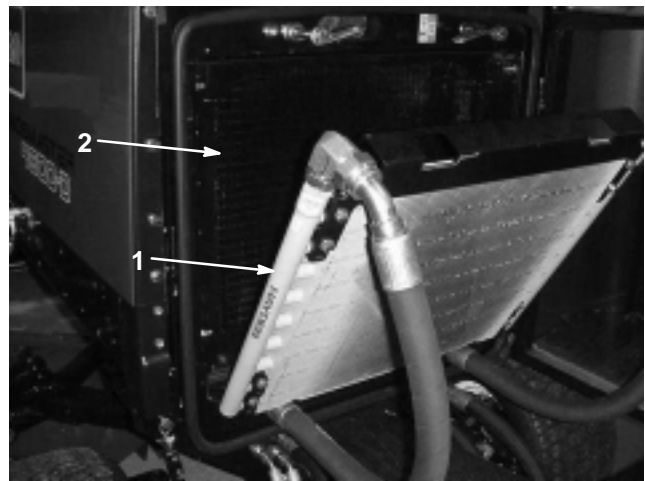

Figure 34

- Oil cooler
- Radiator

Important Cleaning the radiator or oil cooler with water will promote premature corrosion to components and compact debris.

- Pivot the oil cooler back into position. Secure it to the frame with the latches, close the screen.

Servicing the Alternator Belt

Check the condition and tension of the belts (Fig. 35) after every 100 operating hours.

- Proper tension will allow 3/8 in. (10 mm) deflection when a force of 10 lb. is applied on the belt midway between the pulleys.
- If the deflection is not 3/8 in. (10 mm), loosen the alternator mounting bolts (Fig. 35). Increase or decrease the alternator belt tension and tighten the bolts. Check the deflection of the belt again to ensure that the tension is correct.

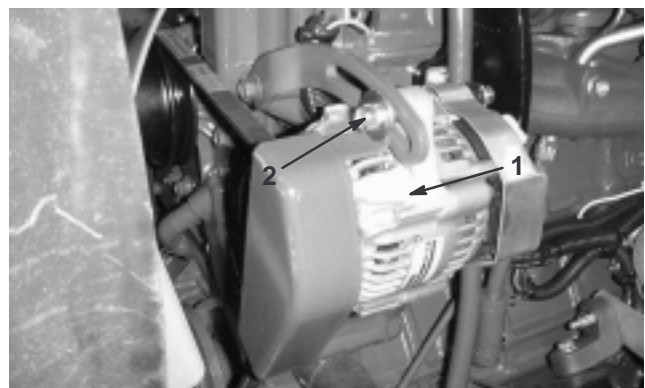

Figure 35

- Alternator
- Mounting bolt

Adjusting the Throttle

Adjust the throttle cable (Fig. 36) so that the governor lever on the engine contacts the low and high speed set bolts before the throttle lever contacts the slot in the seat base.

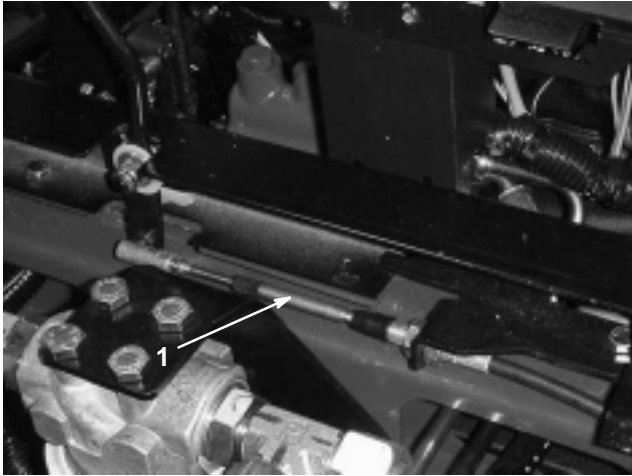

Figure 36

1. Throttle cable

Servicing the Spark Arrestor Muffler

Every 200 hours operation, clear the muffler of carbon buildup.

1. Remove the pipe plug from the clean-out port at the lower side of the muffler.



Caution



The muffler may be hot and could cause injury.
Be careful while working around the muffler.

2. Start the engine. Plug the normal muffler exit with a block of wood or metal plate so that the exhaust flow will be forced out of the clean-out port. Continue to block the exit until carbon deposits cease coming out of the port.



Caution



Do not stand in line with the clean-out port.
Always wear safety glasses.

3. Stop the engine and replace the pipe plug.

Changing the Hydraulic Fluid

Change the hydraulic fluid after every 800 operating hours, in normal conditions. If the fluid becomes contaminated, contact your local Toro distributor because the system must be flushed. Contaminated fluid looks milky or black when compared to clean oil.

1. Turn the engine off and raise the hood.
2. Disconnect the case return line from the bottom of the reservoir and let the hydraulic fluid flow into a large drain pan. Connect the line when the hydraulic fluid stops draining.
3. Fill the reservoir with approximately 7.5 gallons of hydraulic fluid; refer to Checking the Hydraulic Fluid, page 17.

Important Use only the hydraulic fluids specified. Other fluids could cause system damage.

4. Install the reservoir cap. Start the engine and use all of the hydraulic controls to distribute hydraulic fluid throughout the system. Also check for leaks; then stop the engine.
5. Check the fluid level and add enough to raise level the level to the FULL mark on the dipstick. **Do not overfill.**

Replacing the Hydraulic Filters

Change the 2 hydraulic filters initially after the first 200 operating hours. Thereafter, change the filters after every 800 operating hours, in normal conditions.

Use Toro replacement filters Part No. 94-2621 for the rear (cutting unit) of the machine and 75-1310 for the front (charge) of the machine.

Important Use of any other filter may void the warranty on some components.

1. Position the machine on a level surface, lower the cutting units, stop the engine, engage the parking brakes, and remove the ignition key.

- Clean the area around the filter mounting area. Place a drain pan under the filter and remove the filter (Fig. 37 & 38).
- Lubricate the new filter gasket and fill the filter with hydraulic fluid.

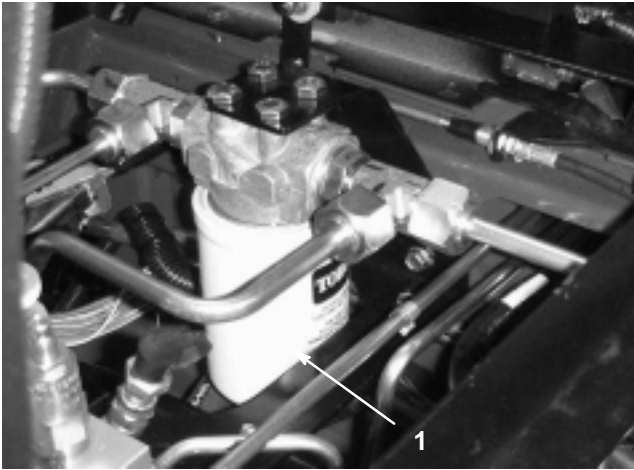

Figure 37

- Hydraulic filter

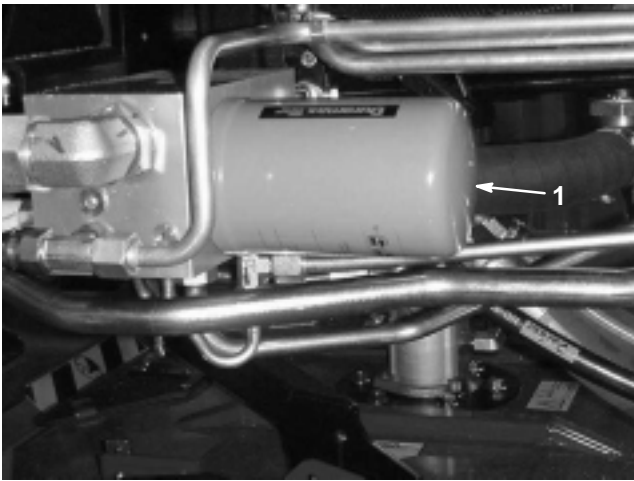

Figure 38

- Hydraulic filter

- Ensure that the filter mounting area is clean. Screw the filter on until the gasket contacts the mounting plate; then tighten the filter an additional 1/2 turn.
- Start the engine and let it run for about two minutes to purge air from the system. Stop the engine and check for leaks.

Checking the Hydraulic Lines and Hoses

Inspect the hydraulic lines and hoses daily for leaks, kinked lines, loose mounting supports, wear, loose fittings, weather deterioration, and chemical deterioration. Make all necessary repairs before operating.



Warning



Hydraulic fluid escaping under pressure can penetrate skin and cause injury.

- Make sure all hydraulic fluid hoses and lines are in good condition and all hydraulic connections and fittings are tight before applying pressure to the hydraulic system.
- Keep your body and hands away from pin hole leaks or nozzles that eject high pressure hydraulic fluid.
- Use cardboard or paper to find hydraulic leaks.
- Safely relieve all pressure in the hydraulic system before performing any work on the hydraulic system.
- Seek immediate medical attention if fluid is injected into skin.

Hydraulic System Test Ports

The test ports are used to test the pressure in the hydraulic circuits. Contact your local Toro distributor for assistance.

Test Port "A" (Fig. 39), located on rear of filter manifold, under right hand frame rail. Used to measure the traction system charge pressure.

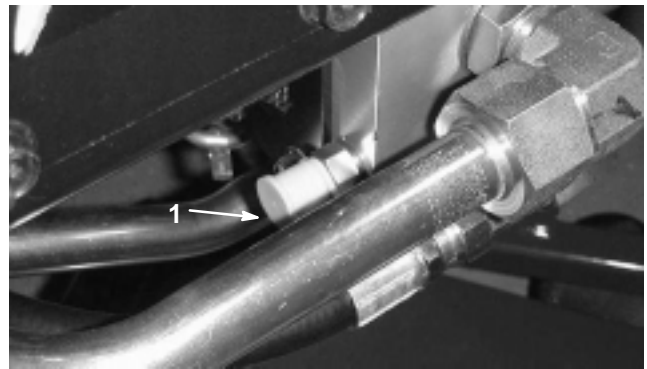

Figure 39

- Test port "A" (Charge)

Test Port “B” (Fig. 40), located on side of counter balance manifold, under operators seat. Used to measure the counter balance pressure applied to cutting units for increased traction.

Test Port “C” (Fig. 40), located on front of 2 wheel drive/4 wheel drive manifold through front access panel on operator platform. Used to measure the 4 wheel drive pressure applied to the rear axle (reverse mode) and rear axle dynamic braking.

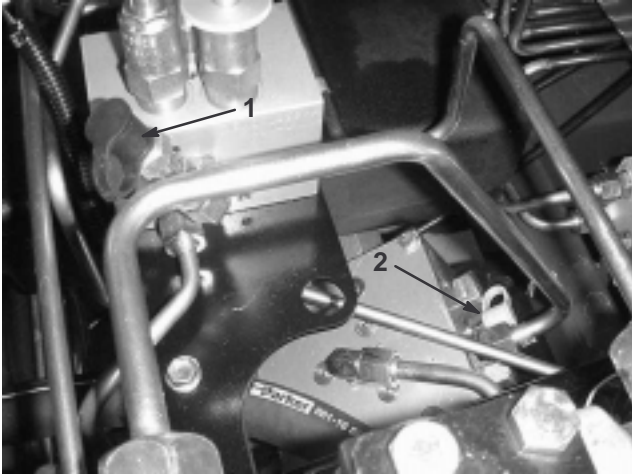

Figure 40

1. Test port “B” (Counter balance)
2. Test port “C” (Four wheel drive)

Test Port “D” (Fig. 41), located on front of pump assembly, under operators seat plate. Used to measure steering pressure.

Test Port “E” (Fig. 41), located on front of pump assembly, under operators seat plate. Used to measure lift circuit pressure.

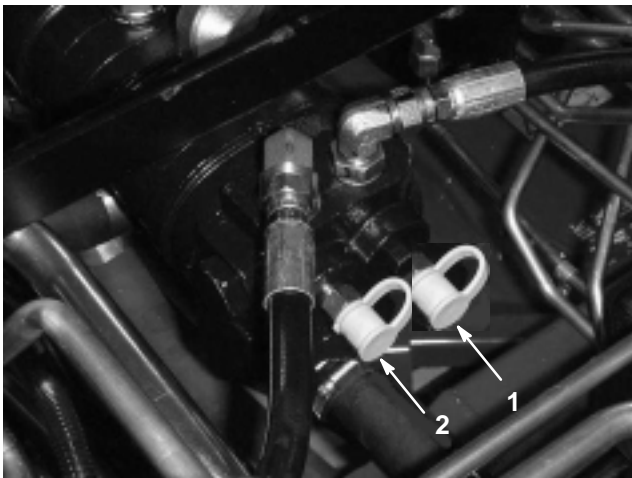

Figure 41

1. Test port “D” (Steering)
2. Test port “E” (Lift circuit)

Test Port “F” (Fig. 42), located on top of right hand deck manifold. Used to measure cutting unit circuit pressure for cutting units 5, 2 and 3.

Test Port “G” (Fig. 42), located on top of left hand deck manifold. Used to measure cutting unit circuit pressure for cutting units 1 and 4.

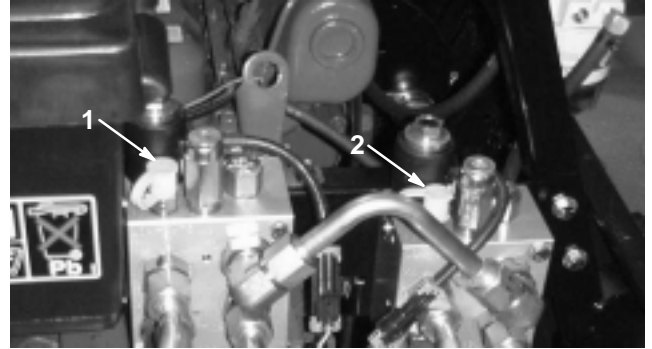

Figure 42

1. Test port “F” (Decks)
2. Test port “G” (Decks)

Test Port “H” (Fig. 43) located on rear traction circuit hard line. Used to measure reverse traction pressure.

Test Port “I” (Fig. 43) located on front traction circuit hard line. Used to measure forward traction pressure



Figure 43

1. Test port “H” (Reverse)
2. Test port “I” (Forward)

Adjusting Counterbalance

The counterbalance dial (Fig. 44) is used to adjust the pressure in the counterbalance circuit. Recommended counterbalance pressure is 620 psi. Rotate the adjusting dial (Fig. 44) clockwise to increase the pressure or counterclockwise to decrease the pressure.

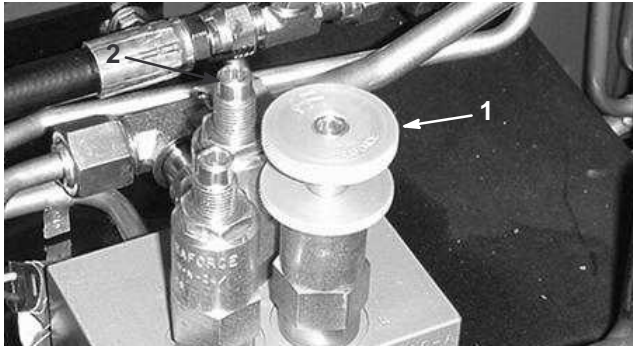

Figure 44

1. Counterbalance dial
2. Traction assist valve

The traction assist valve (Fig. 44) is used to boost the pressure in the counterbalance circuit. Recommended traction assist counterbalance pressure is 700 psi when traction pressure is above 1800 psi. Rotate the valve (Fig. 44) clockwise to increase the pressure or counterclockwise to decrease the pressure.

Important Traction unit must be at operating temperature when adjusting hydraulic pressure.

Adjusting the Traction Drive for Neutral

The machine must not creep when traction pedal is released. If it does creep, an adjustment is required.

1. Park machine on a level surface, shut engine off, position speed control into LOW range and lower cutting units to the floor. Depress only the right brake pedal and engage the parking brake.
2. Jack up left side of machine until left front tire is off the shop floor. Support machine with jack stands to prevent it from falling accidentally.
3. Start engine and allow run at low idle.
4. Adjust jam nuts on pump rod end to move pump control tube forward to eliminate forward creep or rearward to eliminate rearward creep (Fig. 45).

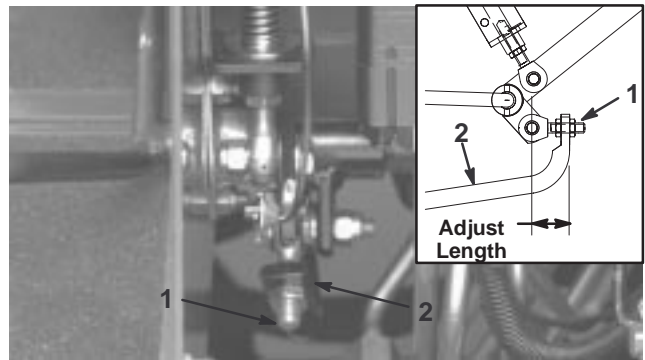

Figure 45

1. Pump rod
2. Pump control tube

5. After wheel rotation ceases, tighten jam nuts to secure adjustment.
6. Stop the engine and release the right brake. Remove jack stands and lower the machine to the shop floor. Test drive the machine to make sure it does not creep.

Adjusting the Service Brakes

Adjust the service brakes when there is more than 1 in. (25 mm) of “free travel” of the brake pedal, or when the brakes do not work effectively. Free travel is the distance the brake pedal moves before braking resistance is felt.

1. Disengage the locking latch from the brake pedals so that both pedals work independently of each other.
2. To reduce free travel of the brake pedals, tighten the brakes:
 - A. Loosen the front nut on the threaded end of the brake cable (Fig. 46).

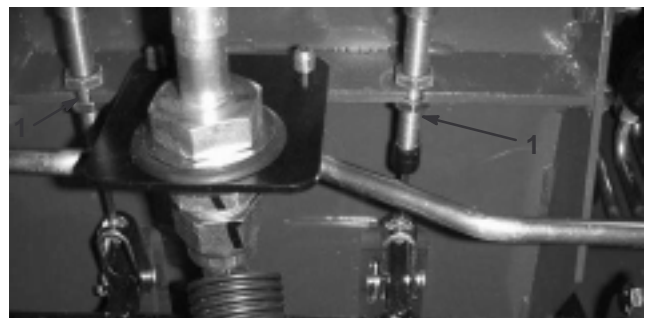

Figure 46

1. Brake cable
 - B. Tighten the rear nut to move the cable backward until the brake pedals have 1/2 to 1 in. (13 to 25 mm) of free travel.
 - C. Tighten the front nuts after the brakes are adjusted correctly.

Changing the Planetary Gear Drive Oil

Change the oil initially after first 200 hours of operation. Thereafter change the oil every 800 hours, or yearly, whichever occurs first. Use a high quality SAE 85W-140 wt. gear lube.

1. With the machine on a level surface, position the wheel so that the check/drain plug (Fig. 47) is at the lowest position (6 o'clock).



Figure 47

1. Check/drain plug
-
2. Place a drain pan under the hub, remove the plug, and allow the oil to drain.
 3. Place another drain pan under the brake housing on the other side of the wheel (Fig. 48).
 4. Remove check/drain plugs from the brake housing and allow the oil to drain.
 5. When all of the oil has drained, install the bottom plug in the brake housing.
 6. Position the wheel so that the plug hole is at the ten or two o'clock position on the planetary.
 7. Slowly add approximately 16 oz. (0.5 l) of high quality SAE 85W-140 wt. gear lube to the planetary fill hole (at the ten or two o'clock position) until the level is up to the bottom of the brake housing check hole. Install the plug.
 8. Repeat the procedure on the opposite planetary/brake assembly.

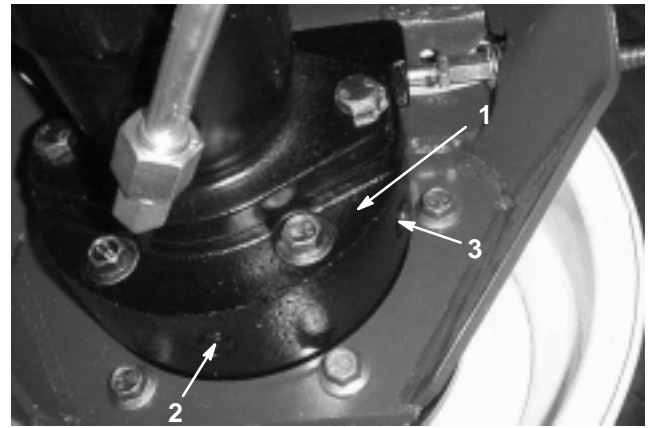

Figure 48

1. Brake housing
2. Drain plug
3. Check plug

Changing the Rear Axle Lubricant

Change the oil initially after the first 200 hours of operation and every 800 hours of operation thereafter.

1. Position the machine on a level surface.
2. Clean the area around the 3 drain plugs, 1 on each end and 1 in the center (Fig. 49).
3. Remove the (3) oil level check plugs and main axle vent cap to ease in draining of the oil.
4. Remove the drain plugs and allow the oil to drain into the pans.

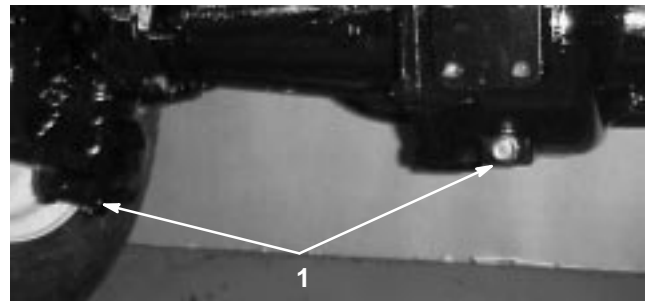

Figure 49

1. Drain plug location
-
5. Install the plugs.
 6. Remove a check plug and fill axle with approximately 80 oz. of 85W-90 gear lube or until lubricant is up to bottom of hole.
 7. Install check plug.

Checking the Rear Wheel Toe-In

After every 800 operating hours or annually, check the rear wheel toe-in.

1. Measure the center-to-center distance (at axle height) at the front and rear of the steering tires. The front measurement must be 1/8 in. (3 mm) less than the rear measurement.
2. To adjust, remove the cotter pin and nut from either tie rod ball joint. Remove tie rod ball joint from axle case support.
3. Loosen the clamps at both ends of the tie rods.

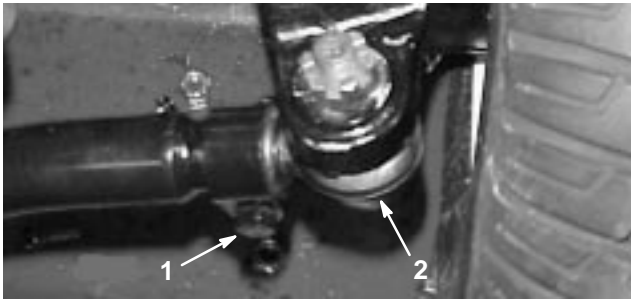

Figure 50

1. Tie rod clamp
2. Tie rod ball joint

4. Rotate the detached ball joint inward or outward one (1) complete revolution. Tighten clamp at loose end of tie rod.
5. Rotate the entire tie rod assembly the same direction (inward or outward) one (1) complete revolution. Tighten clamp at connected end of tie rod.
6. Install the ball joint in the axle case support and tighten the nut finger tight. Measure toe-in.
7. Repeat procedure if necessary.
8. Tighten the nut and install a new cotter pin when the adjustment is correct.

Charging and Connecting the Battery



Warning



CALIFORNIA

Proposition 65 Warning

Battery posts, terminals, and related accessories contain lead and lead compounds, chemicals known to the State of California to cause cancer and reproductive harm. Wash hands after handling.

1. Unlatch and raise the hood.
2. Remove the battery strap and cover (Fig. 51).

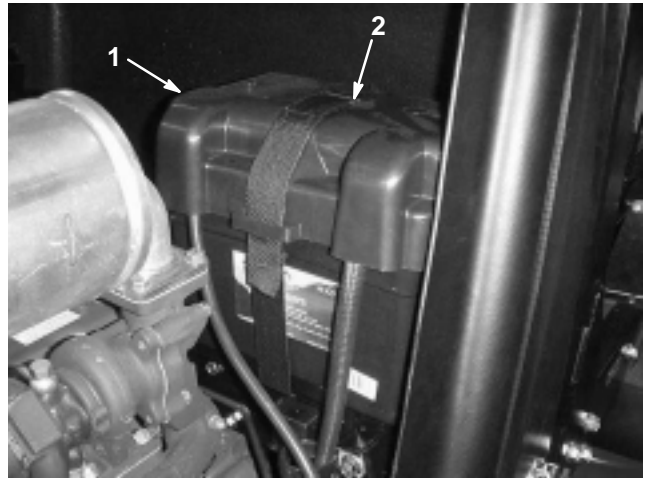

Figure 51

1. Battery cover
2. Battery strap



Danger



Battery electrolyte contains sulfuric acid which is a deadly poison and causes severe burns.

- Do not drink electrolyte and avoid contact with skin, eyes or clothing. Wear safety glasses to shield your eyes and rubber gloves to protect your hands.
- Fill the battery where clean water is always available for flushing the skin.

3. Connect a 3 to 4 amp. battery charger to the battery posts. Charge the battery at a rate of 3 to 4 amperes for 4 to 8 hours.



Warning



Charging the battery produces gasses that can explode.

Never smoke near the battery and keep sparks and flames away from battery.

- When the battery is charged, disconnect the charger from the electrical outlet and battery posts.
- Install the positive cable (red) to the positive (+) terminal and the negative cable (black) to the negative (—) terminal of the battery (Fig). Secure cables to posts with capscrews and nuts. Make sure that the positive (+) terminal is all of the way onto the post and the cable is positioned snug to the battery. The cable must not contact the battery cover. Slide the rubber boot over the positive terminal to prevent a possible short from occurring.

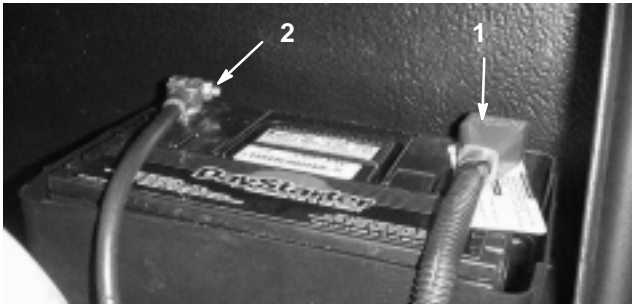

Figure 52

- Positive battery cable
- Negative battery cable



Warning



Battery terminals or metal tools could short against metal components causing sparks. Sparks can cause the battery gasses to explode, resulting in personal injury.

- When removing or installing the battery, do not allow the battery terminals to touch any metal parts of the machine.
- Do not allow metal tools to short between the battery terminals and metal parts of the machine.

- Coat both battery connections with Grafo 112X (skin-over) grease, Toro Part No. 505-47, petroleum jelly, or light grease to prevent corrosion. Slide the rubber boot over the positive terminal.



Warning



Incorrect battery cable routing could damage the machine and cables causing sparks. Sparks can cause the battery gasses to explode, resulting in personal injury.

- Always *disconnect* the negative (black) battery cable before disconnecting the positive (red) cable.
- Always *connect* the positive (red) battery cable before connecting the negative (black) cable.

- Install the battery cover.

Battery Care

Important Before welding on the machine, disconnect the terminal connector from the alternator to prevent damage to the electrical system.

Note: Check the battery condition weekly or after every 50 hours of operation. Keep the terminals and the entire battery case clean because a dirty battery will discharge slowly. To clean the battery, remove it from the machine, wash the entire case with a solution of baking soda and water. Rinse with clear water. Coat the battery posts and cable connectors with Grafo 112X (skin-over) grease (Toro Part No. 505-47) or petroleum jelly to prevent corrosion.

Fuses

There are 4 fuses in the electrical system. They are located under the operators control panel (Fig. 53).

- Rotate latches and remove control panel cover.

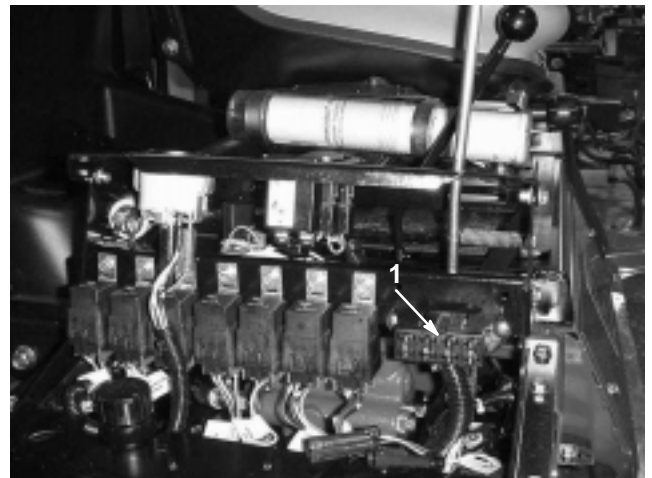
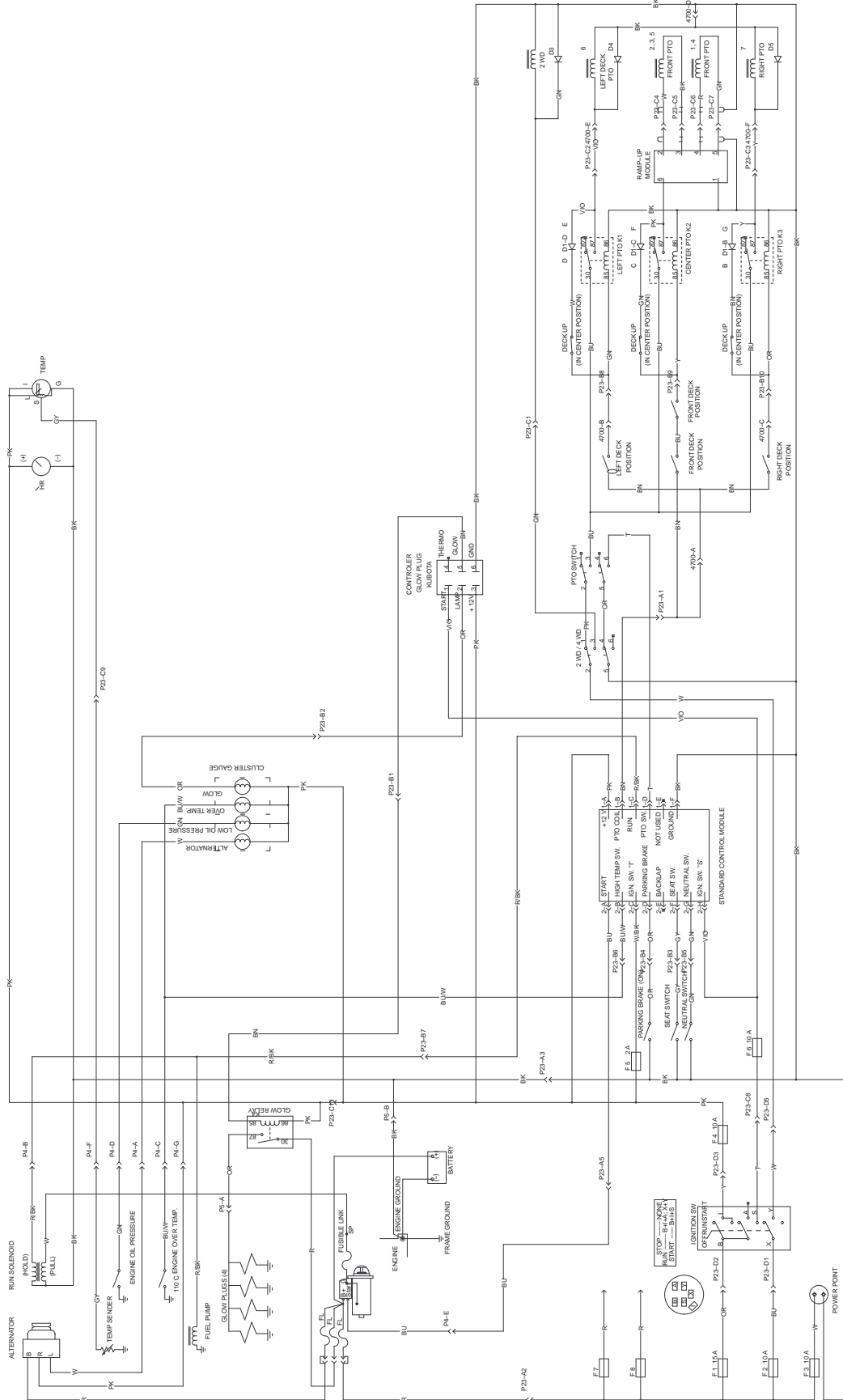

Figure 53

- Fuse block

Electrical Schematic



Hydraulic Schematic

Flows Calc. at 2700 RPM and 98 EFF

COMP.	CIR	GPM	PSI
P1	1.02	11.7	
P2	1.02	11.7	
F3	0.58	6.6	
P4	3.02	34.6	
M1	1.16		2100
M2	1.16		2100
M3	1.16		2100
M4	1.16		2100
M5	1.16		2100
M6	1.16		2100
M7	1.16		2100
MF	2.01		
MR	2.48		
V1	6.1		1800
RV1			620
RV2			700
PR1			450
PRV1			3500
RV2			3500
RV5			550
RV7			2200
RV8			1100
RV9			1100
COMP.	BORE	STROKE	ROD
C1	1.50	4.00	.625
C2	1.50	3.50	.625
C3	1.50	3.50	.625
C4	1.50	7.00	.625
C5	1.50	7.00	.625
C6	2.00	9.00	.750
C7	2.00	9.00	.750
CS	2.00	4.20	.625

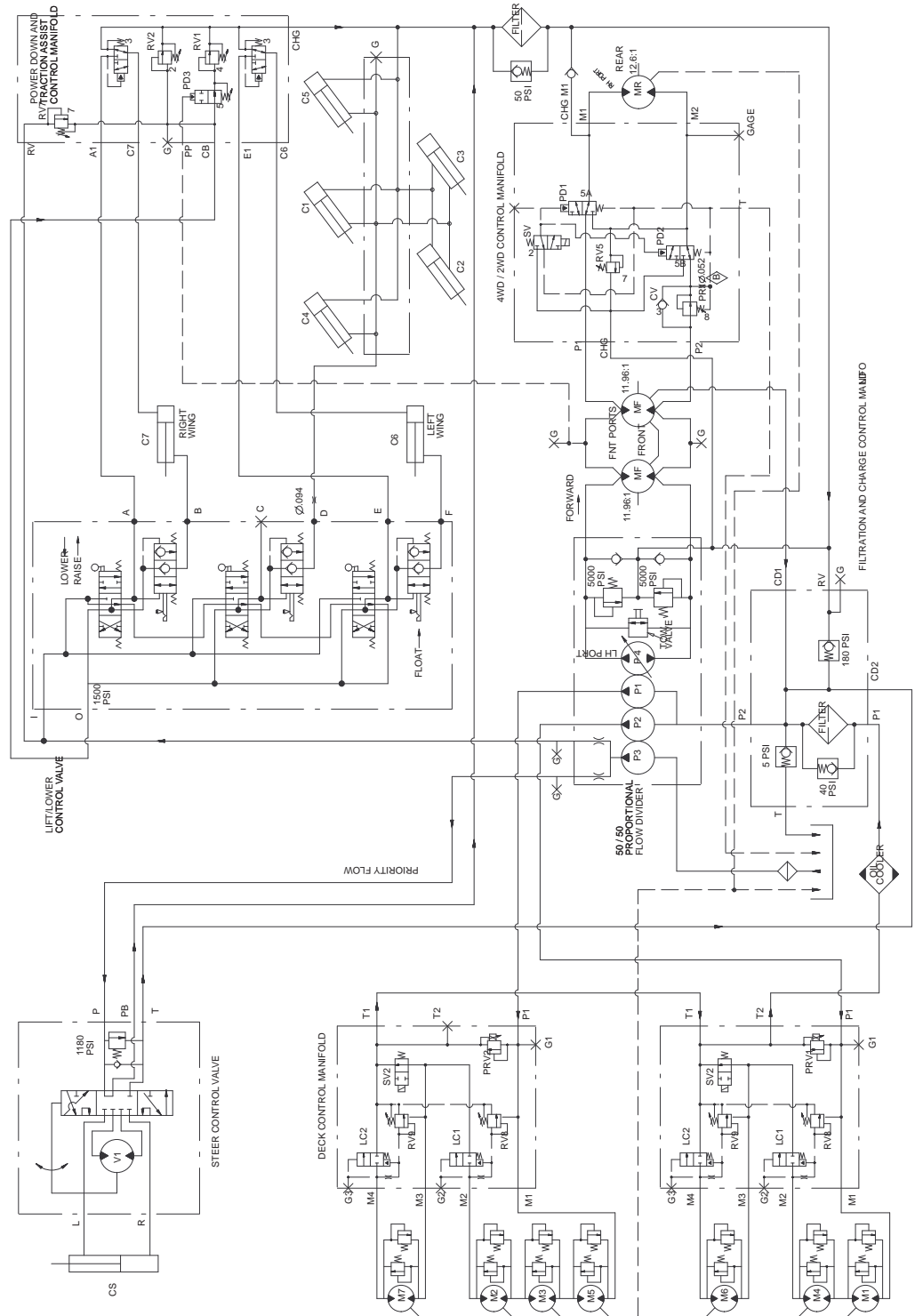

Preparing for Seasonal Storage

Traction Unit

1. Thoroughly clean the traction unit, cutting units, and the engine.
2. Check the tire pressure; refer to Checking the Tire Pressure.
3. Check all fasteners for looseness; tighten as necessary.
4. Grease or oil all grease fittings and pivot points. Wipe up any excess lubricant.
5. Lightly sand and use touch-up paint on painted areas that are scratched, chipped, or rusted. Repair any dents in the metal body.
6. Service the battery and cables as follows:
 - A. Remove the battery terminals from the battery posts.
 - B. Clean the battery, terminals, and posts with a wire brush and baking soda solution.
 - C. Coat the cable terminals and battery posts with Grafo 112X skin-over grease (Toro Part No. 505-47) or petroleum jelly to prevent corrosion.
 - D. Slowly recharge the battery every 60 days for 24 hours to prevent lead sulfation of the battery.

Engine

1. Drain the engine oil from the oil pan and install the drain plug.
2. Remove and discard the oil filter. Install a new oil filter.
3. Refill the oil pan with 8 qt. (7.6 l) of SAE 10W-30 CD, CE, CF, CF-4, or CG-4 motor oil.
4. Start the engine and run it at idle speed for approximately two minutes.
5. Stop the engine.
6. Flush the fuel tank with fresh, clean diesel fuel.
7. Secure all of the fuel system fittings.
8. Thoroughly clean and service the air cleaner assembly.
9. Seal the air cleaner inlet and the exhaust outlet with weatherproof tape.
10. Check the anti freeze protection and add a 50/50 solution of water and ethylene glycol anti-freeze as needed for the expected minimum temperature in your area.



The Toro General Commercial Products Warranty

A Two-Year Limited Warranty

Conditions and Products Covered

The Toro Company and its affiliate, Toro Warranty Company, pursuant to an agreement between them, jointly warrant your Toro Commercial Product ("Product") to be free from defects in materials or workmanship for two years or 1500 operational hours*, whichever occurs first. Where a warrantable condition exists, we will repair the Product at no cost to you including diagnosis, labor, parts, and transportation. This warranty begins on the date the Product is delivered to the original retail purchaser.

* Product equipped with hour meter

Instructions for Obtaining Warranty Service

You are responsible for notifying the Commercial Products Distributor or Authorized Commercial Products Dealer from whom you purchased the Product as soon as you believe a warrantable condition exists.

If you need help locating a Commercial Products Distributor or Authorized Dealer, or if you have questions regarding your warranty rights or responsibilities, you may contact us at:

Toro Commercial Products Service Department
Toro Warranty Company
8111 Lyndale Avenue South
Bloomington, MN 55420-1196
952-888-8801 or 800-982-2740
E-mail: commercial.service@toro.com

Owner Responsibilities

As the Product owner, you are responsible for required maintenance and adjustments stated in your operator's manual. Failure to perform required maintenance and adjustments can be grounds for disallowing a warranty claim.

Items and Conditions Not Covered

Not all product failures or malfunctions that occur during the warranty period are defects in materials or workmanship. This express warranty does not cover the following:

- Product failures which result from the use of non-Toro replacement parts, or from installation and use of add-on, modified, or unapproved accessories
- Product failures which result from failure to perform required maintenance and/or adjustments
- Product failures which result from operating the Product in an abusive, negligent or reckless manner
- Parts subject to consumption through use unless found to be defective. Examples of parts which are consumed, or used up, during normal Product operation include, but are not limited to, blades, reels, bedknives, tines, spark plugs, castor wheels, tires, filters, belts, etc.

Countries Other than the United States or Canada

Customers who have purchased Toro products exported from the United States or Canada should contact their Toro Distributor (Dealer) to obtain guarantee policies for your country, province, or state. If for any reason you are dissatisfied with your Distributor's service or have difficulty obtaining guarantee information, contact the Toro importer. If all other remedies fail, you may contact us at Toro Warranty Company.

- Failures caused by outside influence. Items considered to be outside influence include, but are not limited to, weather, storage practices, contamination, use of unapproved coolants, lubricants, additives, or chemicals, etc.
- Normal "wear and tear" items. Normal "wear and tear" includes, but is not limited to, damage to seats due to wear or abrasion, worn painted surfaces, scratched decals or windows, etc.

Parts

Parts scheduled for replacement as required maintenance are warranted for the period of time up to the scheduled replacement time for that part.

Parts replaced under this warranty become the property of Toro. Toro will make the final decision whether to repair any existing part or assembly or replace it. Toro may use factory remanufactured parts rather than new parts for some warranty repairs.

General Conditions

Repair by an Authorized Toro Distributor or Dealer is your sole remedy under this warranty.

Neither The Toro Company nor Toro Warranty Company is liable for indirect, incidental or consequential damages in connection with the use of the Toro Products covered by this warranty, including any cost or expense of providing substitute equipment or service during reasonable periods of malfunction or non-use pending completion of repairs under this warranty. Except for the Emissions warranty referenced below, if applicable, there is no other express warranty. All implied warranties of merchantability and fitness for use are limited to the duration of this express warranty.

Some states do not allow exclusions of incidental or consequential damages, or limitations on how long an implied warranty lasts, so the above exclusions and limitations may not apply to you.

This warranty gives you specific legal rights, and you may also have other rights which vary from state to state.

Note regarding engine warranty: The Emissions Control System on your Product may be covered by a separate warranty meeting requirements established by the U.S. Environmental Protection Agency (EPA) and/or the California Air Resources Board (CARB). The hour limitations set forth above do not apply to the Emissions Control System Warranty. Refer to the Engine Emission Control Warranty Statement printed in your operator's manual or contained in the engine manufacturer's documentation for details.