



# RXC

## User Guide



RXC

ALARM



RAIN DELAY



ON/OFF

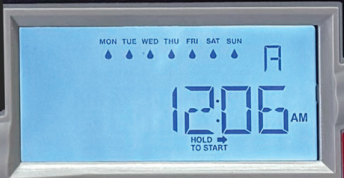

WIRELESS LINK





# Table of Contents

## Components

Timing Mechanism - - - - -	4
Internal Components - - - - -	4

## Installation

Cabinet Installation - - - - -	6
Power Supply Installation - - - - -	7
Removing Conduit Knockouts - - - - -	7
Valve Installations - - - - -	8
Rain Sensor Installation - - - - -	9
Flow Sensor Installation - - - - -	9
Wi-Fi Module Installation - - - - -	9

## Setup and Programming

Program Overview - - - - -	10
Set DATE & TIME - - - - -	10
Set START TIMES - - - - -	10
Set RUN TIMES - - - - -	11
Set WATER DAYS - - - - -	11
Set SEASONAL ADJUST - - - - -	13
Set WEATHER SENSORS - - - - -	13
Set FLOW - - - - -	14

### SETTINGS

GROW IN - - - - -	15
Simultaneous Stations - - - - -	15
Master Valve Type - - - - -	15
Station Delay - - - - -	15
Station Delay Active for MV - - - - -	15
Clock Settings - - - - -	16
Dry Out Days - - - - -	16
FW (Firmware) Version - - - - -	16
WiFi Version - - - - -	16
Enable Bluetooth - - - - -	16
Clear WiFi - - - - -	16

### SPECIAL SETTINGS

Master Valve ON/OFF per Station - - - - -	17
Clear SETTINGS to Factory Default - - - - -	17

## Manual Operation

Manually Activate All Stations - - - - -	18
Manually Activate a Program - - - - -	18
Manually Activate Station(s) - - - - -	18

**Rain Delay - - - - - 18**

**Update Firmware - - - - - 18**

**Warnings and Alerts - - - - - 19**

**Product Accessories - - - - - Back Cover**

**Specifications - - - - - Back Cover**

**FCC/IC Statement - - - - - Back Cover**

# Components

## Timing Mechanism Components

Figure 1

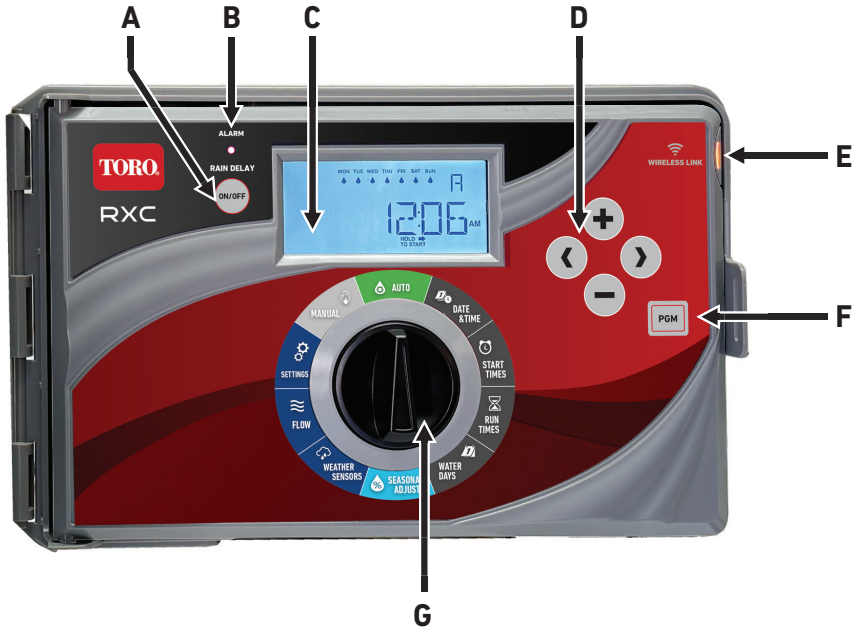

## Internal Components

Figure 2

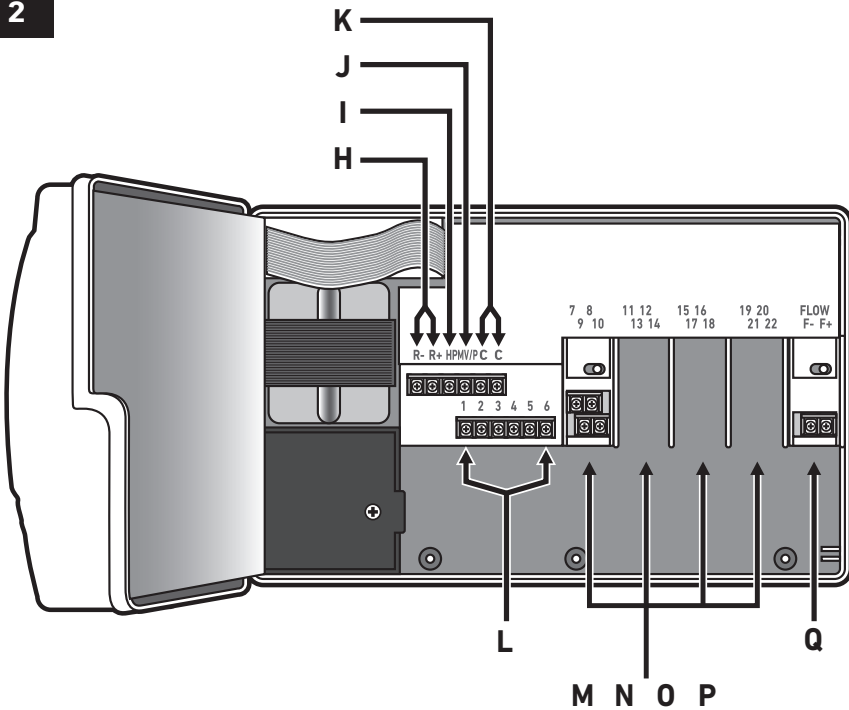

- A – Rain Delay, ON/OFF** - Pause automatic irrigation or start rain delay for a set number of days.
- B – Status Indicator** - Status LED will indicate whether the controller is currently irrigation, on rain delay or fault in the system is encountered.
- C – LCD Display** - Controller information will be displayed on the screen.
- D – Navigation buttons** - Use the navigation buttons to move through the menu system and select or modify values and parameters.
- E – RXC Wi-Fi Module** - Install the RXC Wi-Fi module (RXC-WIFI) to connect smart devices to RXC. Download Toro Oasis irrigation management App to connect.
- F – Program Button** - Use to select the desired program to edit.
- G – Function Dial** - Use the function dial to select parameters you want to modify.
- H – Rain Sensor Terminals** - Attach Normally Open or Normally Closed rain sensor to the **R-** and **R+** terminals.
- I – HP Terminal** - 24V power for add-on accessories and testing solenoid wires.
- J – Master Valve/Pump (MV/P) Terminals** - Attach one of the wire from master valve or pump relay to the **MV/P** terminal and the other wire to one of the Common (**C**) terminal.
- K – Common (C) Terminals** - Valve Common terminals. Attach one of the wire leads of your station(s) and master valve/pump relay to one of these terminals.
- L – Stations 1 through 6 Terminals** - Attach one station valve wire to the corresponding station number and the other to the valve common terminal.
- M – Stations 7 through 10 Expansion Module Slot** - Install a 4-Station expansion module to expand station count to 10 Stations.
- N – Stations 11 through 14 Expansion Module Slot** - Install a 4-Station expansion module to expand station count to 14 Stations.
- O – Stations 15 through 18 Expansion Module Slot** - Install a 4-Station expansion module to expand station count to 18 Stations.
- P – Stations 19 through 22 Expansion Module Slot** - Install a 4-Station expansion module to expand station count to 22 Stations.
- Q – Flow Sensor Module Slot** - Install a Flow Module into this location to access flow sensor capabilities. Go to Flow Dial selection menu to set your flow sensor parameters.

# Installation

## Cabinet Installation

1. For safe and reliable operation, select an installation site which can ideally provide the following conditions:
  - For indoor model controllers – Inside a garage or other structure which will provide protection from the weather.
  - For outdoor model controllers – Protection from irrigation spray, wind and snow. A covered location is recommended.
  - Access to a grounded AC power source (within 4' [1.2m] for indoor models) which is not controlled by a light switch or utilized by a high current load appliance, such as a refrigerator or air conditioner.
  - For outdoor installation, RXC unit with provided cord must be connected to a dedicated outdoor rated enclosure with GFCI.
  - Access to the sprinkler control valve wiring and optional accessory wiring.
2. The provided 10-12 x 1.5" screws are for mounting to a wood wall stud.

For mounting into drywall or masonry, use the appropriate type of screw anchors or fasteners (not provided) to ensure secure installation.

Drywall - 1/4" Drywall Anchor

Masonry - #12-16 Masonry Anchor

Install all anchors per manufacturer's specifications.

Drive a 10-12 x 1.5" screw (provided) into the wall at eye level. Leave the screw extended approximately 1/4" (6mm) from the wall. See **Figure 2**.

**NOTE:** If installing the controller on drywall or masonry, install screw anchors.

3. Hang the cabinet on the screw using the slot on the back panel. Make sure the cabinet slides down securely on the screw.
4. Open the cabinet door. Open the timing mechanism to access the center screw hole. Insure that the cabinet is level, then secure the cabinet with the provided 10-12 x 1.5" screw. See **Figure 3**.

**NOTE:** Conduit and adapters are not provided. Install conduit as required by local electrical codes.

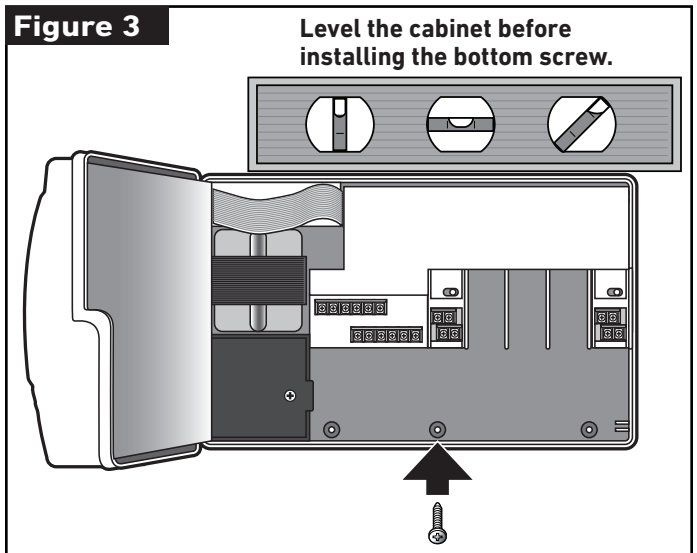
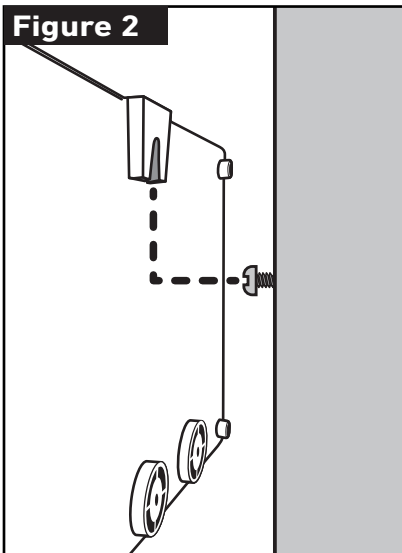

## Power Supply Installation

### IMPORTANT SAFETY INSTRUCTIONS



THIS PRODUCT MUST BE INSTALLED IN ACCORDANCE WITH THE APPLICABLE INSTALLATION CODE AND LOCAL JURISDICTION BY A PERSON FAMILIAR WITH THE CONSTRUCTION, INSTALLATION, AND OPERATION OF THE PRODUCT AND THE HAZARDS INVOLVED.

THE USE OF OR INSTALLATION OF JUNCTION BOXES, CONDUIT BODIES, AND FITTINGS SHALL BE FOR THE INSTALLATION AND INTENDED USE AND IN ACCORDANCE WITH APPLICABLE NATIONAL ELECTRICAL CODE. CONSULT WITH A QUALIFIED ELECTRICIAN AND LOCAL ELECTRICAL CODES BEFORE INSTALLING ANY ELECTRICAL PRODUCT. DISCONNECT ALL POWER BEFORE SERVICING. ENSURE MAIN AC BREAKER IS OFF. GFCI PROTECTION IS REQUIRED ON ALL EQUIPMENT OPERATED OUTDOOR OR WET LOCATIONS. FAILURE TO COMPLY MAY RESULT IN SERIOUS INJURY DUE TO ELECTRICAL SHOCK HAZARD.

1. Verify that the power is turned off at the source.
2. The RXC comes pre-installed with a power supply cable ready to plug into a 120 VAC, 60hz power outlet. See **Figure 4**.

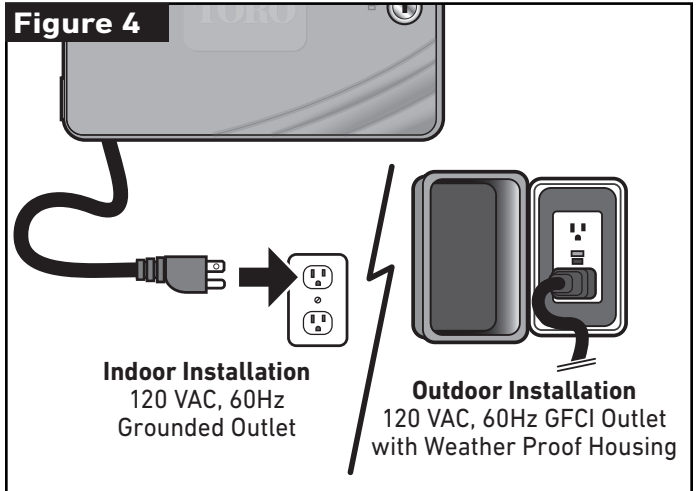

## Removing Conduit Knockouts

1. Locate the conduit knockout access you would like to remove.
2. Use a screw driver and a hammer to remove the access cover. Use three recommended locations on **Figure 5** to place hard but firm blows. The blows should be hard enough to place a puncture at the breakaway area at location 1 and 2. At location 3, continue the blows until the conduit cover breaks away from the cabinet. See **Figure 5**.
3. Remove the conduit cover and use a de-burring tool to clean the opening from sharp edges.
4. Install the appropriate conduit in accordance with local and national electrical and building codes.

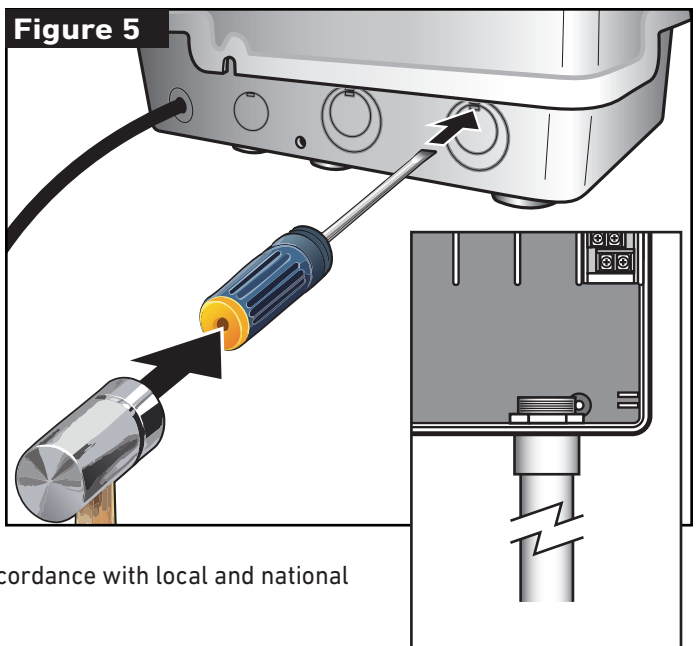

## Valve Installation - Conventional Stations

The RXC is equipped with 6 conventional station outputs. Additional stations can be added by installing a 4-station module. The RXC can accommodate up to 22 total conventional stations.

**CAUTION:** Maximum screw torque on the output terminal not to exceed 5 in-lbs.

1. Route the valve wires or wire cable from the valves, into the controller cabinet.

**NOTE:** 18AWG (1.0mm<sup>2</sup>) multi-wire sprinkler valve connection cable can be used. This cable is insulated for direct burial and is color-coded to simplify installation. It can be routed directly into the controller through the access hole provided for valve wire conduit (if conduit is not used). Wire splices and field connections must be insulated using TW-SPLICE-14 waterproof wire connectors (or equivalent).

2. Attach the white color-coded wire from the cable to one wire from each valve solenoid. (Either solenoid wire can be used for this connection.) This is called the "Valve Common" wire. See **Figure 6**.
3. Attach a separate cable wire to the remaining wire from each valve solenoid. Note the wire color code used for each valve and the watering station it controls. You will need to have this information when connecting the valve wires to the controller.
4. Secure all wire splices using wire nut connectors. To prevent corrosion and possible short circuits, always use an insulated wire nut, grease cap or similar waterproofing method.
5. At the controller end of the valve connection cable, strip back 1/4" (6mm) of insulation from all cable wires

6. Secure the Valve Common wire to the terminal labeled **C**. Connect the individual valve wires to the appropriate station terminals (**1** for station 1, **2** for station 2, etc.) Connect the master valve wire (if applicable) to the terminal labeled **MV/P**.

**NOTE:** Connecting a master valve or pump start relay is optional and may not be required for your sprinkler system. RXC can operate normally open and normally closed master valves.

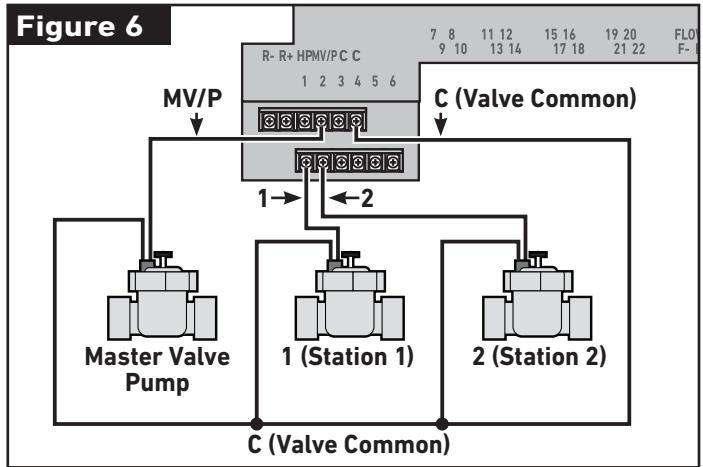

## Rain Sensor Installation

The RXC is equipped with rain sensor inputs. RXC can support both normally closed and normally open type of sensors, and can be assigned per station basis. When the sensor is activated (rain sensor detects rain), RXC will suspend watering operations to all stations that are assigned to that sensor.

1. Route the wire cable from the rain switch sensor into the controller.
2. Remove the jumper wire from the sensor terminals.
3. Referring to the instructions provided with the rain sensor, connect two wires from the rain sensor designated for "Normally Closed" applications to the sensor terminals **R-** and **R+**. See **Figure 7**.

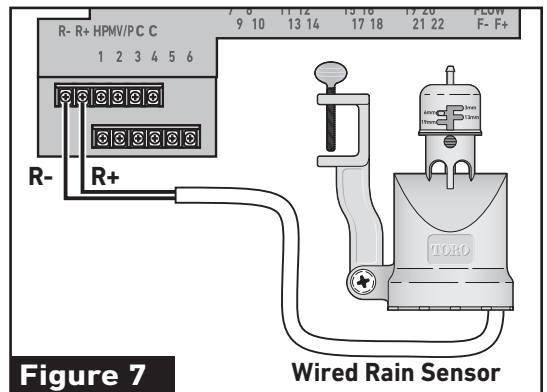

## Flow Sensor Installation

The RXC can be equipped with a flow sensor. In order to use a flow sensor, you must install the optional Flow Sensor Module.

1. Install the optional flow sensor module by sliding it into the RXC's **FLOW F- F+** location. See **Figure 8**.

2. Route the flow sensor wires into the RXC cabinet.

**NOTE:** 18AWG (1.0mm<sup>2</sup>) multi-wire sprinkler valve connection cable can be used. This cable is insulated for direct burial and is color-coded to simplify installation. It can be routed directly into the controller through the access hole provided for valve wire conduit (if conduit is not used). Wire splices and field connections must be insulated using TW-SPLICE-14 waterproof wire connectors (or equivalent).

3. Secure all wire splices using wire nut connectors. To prevent corrosion and possible short circuits, always use an insulated wire nut, grease cap or similar waterproofing method.
4. Referring to the instructions provided with the flow sensor, connect the two wires from the flow sensor to the sensor terminals **F-** and **F+**.

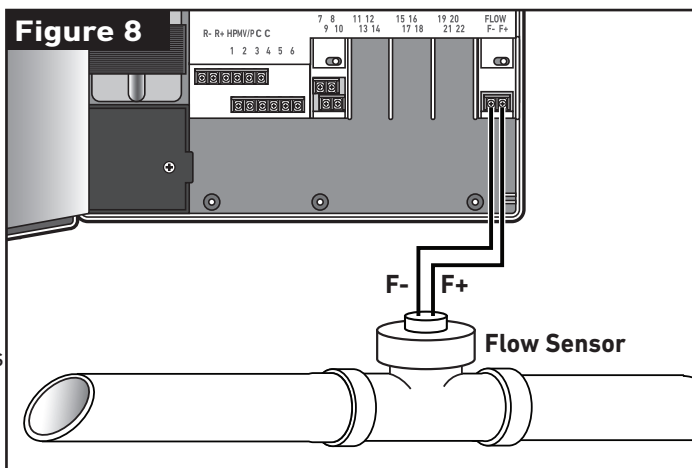

## Wi-Fi Module Installation

The RXC can be equipped with a Wi-Fi Module to use with Toro Oasis irrigation management App so you can access the controller with your smart device.

1. Plug the RXC Wi-Fi module into the timing mechanism as shown in **Figure 9**.

2. Once plugged in, the Wi-Fi module will start blinking to indicate that it is ready to pair with your smart device.

3. From your smart device, launch Toro Oasis. If first time launching the application, create a user account and add your property details.

4. Add your RXC controller using the **Add System** button. Press **Continue** to confirm.

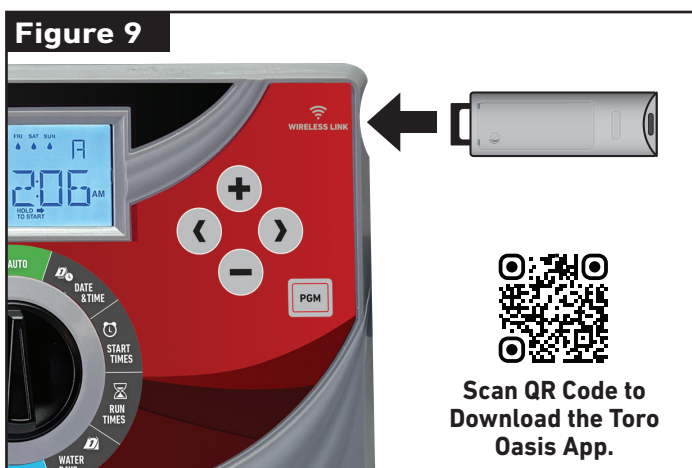

5. Select the RXC controller from the Bluetooth device list that Oasis has detected.
6. Enter a name and description for the controller and press **Add Controller**.
7. Access the controller to set your programs and zones.



# Setup and Programming

## Program Overview

The RXC controller can have up to six automatic irrigation programs (**A** through **F**). Each program may have up to six start times. For each start time, the program will cycle through all the assigned stations until their set run time is fulfilled.

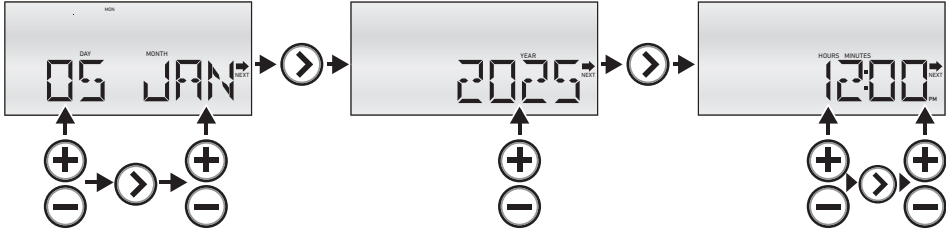
## Set DATE & TIME





1. Place the control dial to **DATE & TIME**  position.
2. Use the **+** or **-** button to adjust the current day. Press the **➡** button to advance to the month position.
3. Use the **+** or **-** button to adjust the current month. Press the **➡** button to advance to the year position.
4. Use the **+** or **-** button to adjust the current year. Press the **➡** button to advance to the hour position.
5. Use the **+** or **-** button to adjust the current hour. Press the **➡** button to advance to the minutes position.
6. Use the **+** or **-** button to adjust the current minutes. Pressing the **➡** button will cycle back to the day position.
7. Place the dial back to **AUTO**  when finished.

## Set START TIMES

Each program may have up to six start times. For each start time, the program will cycle through all the assigned stations until their set run time is fulfilled.

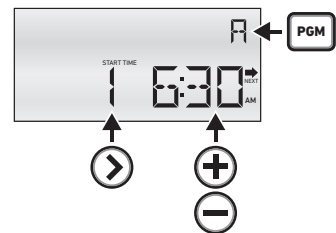
1. Place the control dial to **START TIMES**  position.
2. Use the **PGM** button to select the program being modified. RXC can have up to six automatic irrigation programs (**A** through **F**).
3. Each RXC program can have up to six start time. Use the **+** or **-** button to adjust the start time number. Start time will increase/decrease in 15-minute increments. Press and hold the **+** or **-** button for faster scrolling speed.





- To disable a start time, set to OFF. The OFF setting is located between 11:45pm and 12:00am.
4. Press the **➡** button to select the next start time to adjust if necessary. Repeat Step 3 to set or adjust additional start times.
  5. Repeat Steps 2-4 to set start times to additional programs.
  6. Place the dial back to **AUTO**  when finished.

## Set RUN TIMES

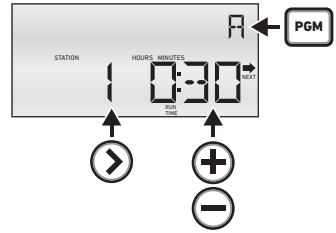
Run time is the set duration that a particular station will irrigate when a program is activated. For each program start, the station will activate until the set run time is fulfilled. The run time will be adjusted accordingly when SEASONAL ADJUST is increased or decreased.





1. Place the control dial to **RUN TIMES**  position.
2. Use the **PGM** button to select the program being modified. RXC can have up to six automatic irrigation programs (**A** through **F**).
3. Use the **+** or **-** button to adjust the run time in minutes. Press and hold the **+** or **-** button for faster scrolling speed.
4. Press the **➤** button to select the next station or **◀** to select the previous station. Repeat Step 3 to set or adjust the run time.
5. Repeat Steps 2-4 to set station run times to additional programs.
6. Place the dial back to **AUTO**  when finished.

## Set WATER DAYS

For each program, the RXC can set a unique watering schedule. Program A may have Mondays as non-watering day but Program B may have Mondays as an active watering day. In addition, each program may be set with ODD or EVEN calendar days to water or a set watering interval number such as every 3rd or 4th day.

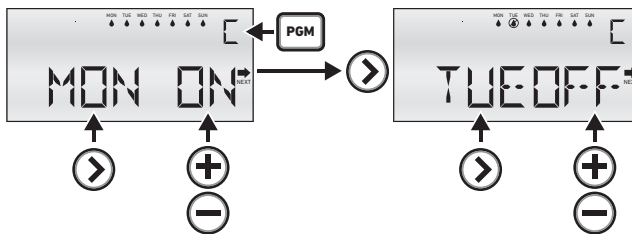
### Set Days of the Week to ON or OFF





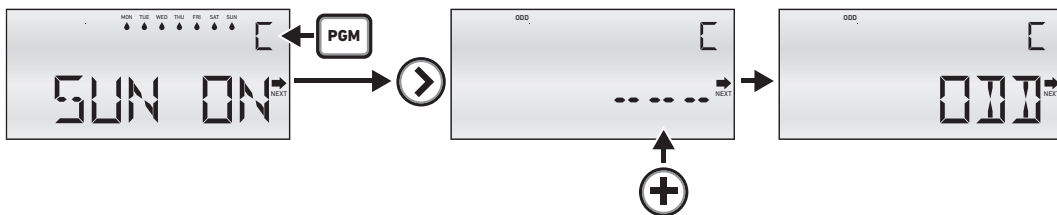

1. Place the control dial to **WATER DAYS**  position.
2. Use the **PGM** button to select the program being modified. RXC can have up to six automatic irrigation programs (**A** through **F**).
3. Each of the days of the week (MON, TUE, WED, THU, FRI, SAT and SUN) can be set to ON or OFF. Use the **+** or **-** button to set the selected day to ON or OFF. Press the **➤** button to select the next day of the week.
4. After the SUN (Sunday) selection, make sure the menu selection is set at ---. If ODD, EVEN or INT is selected, in addition to the deactivated days, it will also follow the selected ODD, EVEN or INT (interval) schedule.
5. Place the dial back to **AUTO**  when finished.

### Set Schedule to ODD or EVEN

Setting the program schedule to ODD or EVEN will prompt RXC to activate the program only during the ODD or EVEN numbered days in the current calendar month. ODD will water on the 1st, 3rd, 5th, etc. of current month. EVEN will water on the 2nd, 4th, 6th, etc. of the current month.







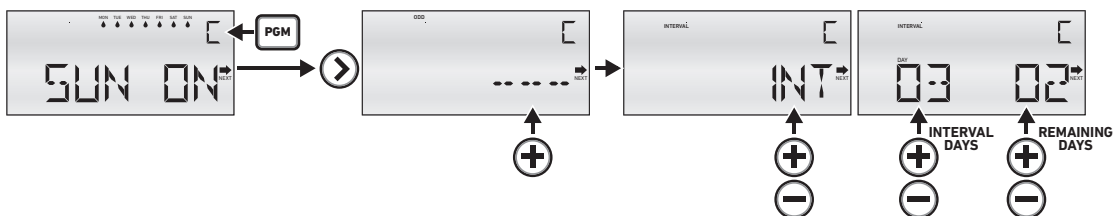

1. Place the control dial to **WATER DAYS**  position.
2. Use the **PGM** button to select the program being modified. RXC can have up to six automatic irrigation programs (**A** through **F**).
3. Press the  button until ODD, EVEN, INT or - - - is displayed.
4. Press the  button until the desired schedule is displayed (ODD or EVEN). Set to - - - to turn off.
5. Place the dial back to **AUTO**  when finished.

### Set Schedule to INT (Interval)

Setting the program schedule to Interval will prompt RXC to activate the program at the set interval number. Selecting 3 will prompt RXC to water every 3rd day. Set interval to 4 to activate the program every 4th day, etc.





1. Place the control dial to **WATER DAYS**  position.
2. Use the **PGM** button to select the program being modified. RXC can have up to six automatic irrigation programs (**A** through **F**).
3. Press the  button until ODD, EVEN, - - - or INT is displayed.
4. If ODD, EVEN or - - - is displayed, press the  button until the INT is selected, then press the  button to access INT settings.
5. Press the  button to set the interval number (3 for every 3rd day, 4 for every 4th day, etc.).
6. Press the  button to set the remaining days until watering. If schedule is set to 3 (every 3rd day) and you want watering to start the next day, set the remaining day to **01**. At day change, the remaining day(s) will be decremented to **00** and designated as an active day. Set to - - - to turn off.
7. Place the dial back to **AUTO**  when finished.

## Set SEASONAL ADJUST

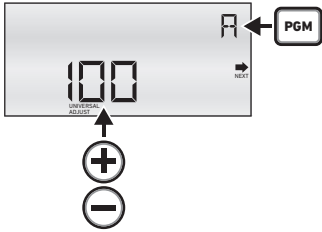
The RXC can set each program a unique Seasonal Adjust value. The Seasonal Adjust is a program specific adjustment to increase or decrease irrigation in 10% increments/decrements. The adjustment can be decreased all the way to OFF (0%) and increased to the maximum of 200%. At 100%, there is no seasonal adjustment applied to Station Run Times.





1. Place the control dial to **SEASONAL ADJUST**  position.
2. Use the **PGM** button to select the program being modified. RXC can have up to six automatic irrigation programs (**A** through **F**).
3. Set a global adjustment percentage to the selected program. Press the **+** to increase or **-** to decrease watering accordingly. Press and hold the button for faster scrolling.
4. Repeat Steps 2 and 3 to set Seasonal Adjust to additional programs.
5. Place the dial back to **AUTO**  when finished.

## Set WEATHER - SENSORS

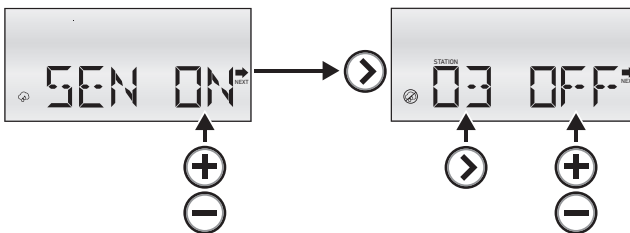
The RXC can support cloud-based weather adjustment when connected to the Oasis mobile app. The cloud-based weather adjustment can be applied to any program A-F and will adjust station run times based on daily weather for the area. For the RXC to recognize the cloud-based weather, it has to be activated (sensor is set to **ON**) in the SENSORS dial menu.









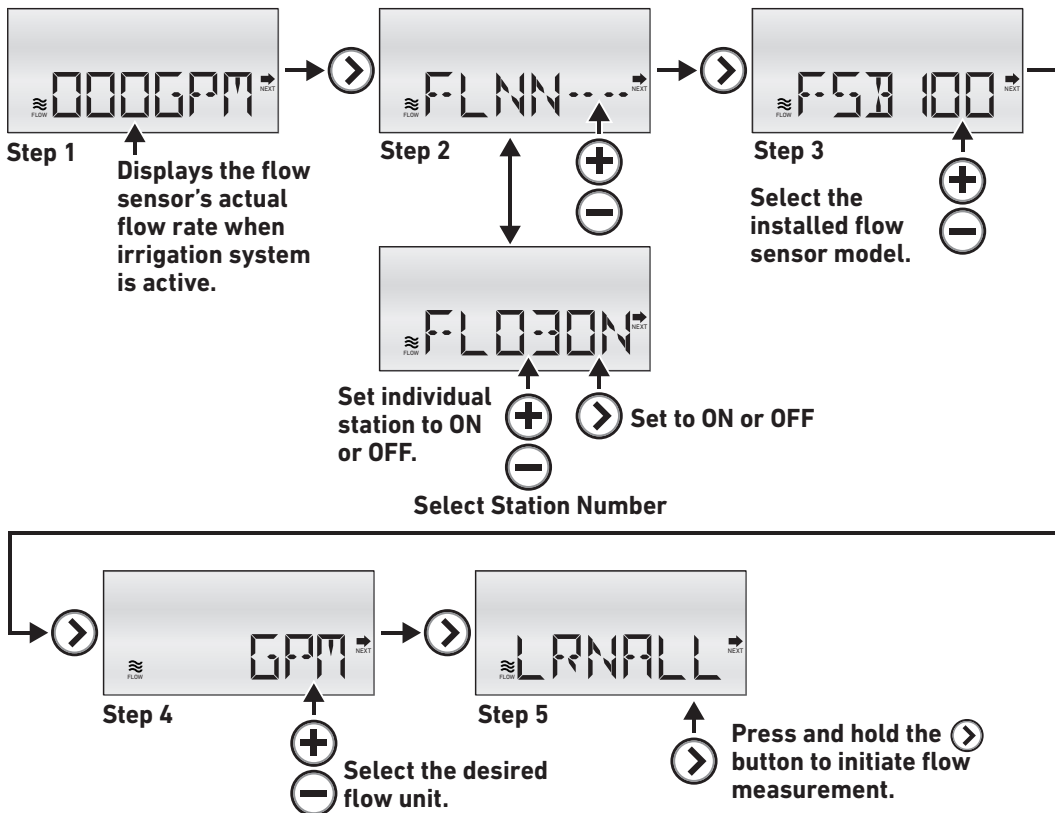







1. Place the control dial to **SENSORS**  position.
2. Press **+** to activate (**SEN ON**) or deactivate (**SEN OFF**) the rain sensor.
3. Once SEN is set to ON, by default, all available stations will have sensor set to ON. Each day, the Oasis app will apply a daily water budget amount to all stations set to ON.
4. Set specific stations to OFF for that station to ignore the cloud-based weather. When set to OFF, those station(s) will not be affected by daily cloud-based weather adjustments. Press the **>** button to the specific station that will ignore the rain sensor function. Press the **+** button to set to **OFF**. Repeat Step 4 to set additional stations to **OFF** if necessary.
5. Place the dial back to **AUTO**  when finished.

## Set FLOW

The RXC can be equipped with a flow sensor to help manage proper irrigation operation. With a flow sensor, the RXC can detect flow malfunctions in the irrigation system and can immediately perform mitigating actions to limit water loss or system damage. For RXC to properly operate with the flow sensor, you must enter the proper settings in the FLOW dial menu.



1. Place the control dial to **FLOW**  position. The initial screen will display the flow sensor's actual flow rate when the irrigation system is running. Press the  button to advance to the next menu.
  2. The next display menu will set individual stations that the flow sensor serves. Press the  or  button to select the station and use the  button to set the selected station number to ON or OFF. To advance to the next setting, return to the **FLNN ---** menu and press the  button. By default, all stations are set to **ON** and will use the flow sensor.
  3. This setting allows you to assign the flow sensor model being used. Press the  or  button to select the flow sensor models that are compatible with the RXC. Press the  button to advance to the next setting.
  4. Press the  or  button to select the desired flow unit, GPM (gallons per minute) or LPM (liters per minute). Press the  button to advance to the next setting.
  5. This setting allows the RXC to learn the flow measurement of the installed flow sensor. This measurement will be used to calculate flow errors in the system. To initiate learn flow, press and hold the  button until the flow sensor is activated. Once the procedure is finished, the learned flow will be displayed in Step 1 screen.
- Once learned flow is established, the RXC will alarm if an underflow, overflow, or unscheduled flow is detected on a station. Alarms can be cleared once the irrigation issue is resolved by following the on-screen prompt.
6. Place the dial back to **AUTO**  when finished.

## SETTINGS

Press the  button while in Settings to scroll through the menu options.

### GROW IN

Use the Grow setting to set the number of days the GROW IN will be implemented.

The GROW IN program is enabled by setting a number of days for grow-in irrigation. Once a number of days is set, Program G will be made available. The grow-in program will only be active during the set GROW IN days. Once the GROW IN days are complete, program

G will no longer be available. Press the  button to navigate to program G. Program G is for a GROW IN schedule which is used to establish new landscape. Use the START TIMES, RUN TIMES, and WATER DAYS dial positions to setup the grow-in program (Program G). Any station used in program G during the GROW IN period will be ignored in any other program (A-F) while the GROW IN period is active. Once the GROW IN period is complete, any station previously in the GROW IN program that is used in program A-F will resume their normally programmed irrigation.

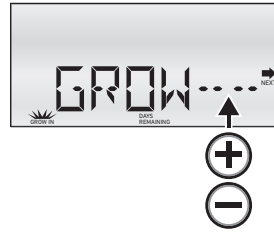

### Simultaneous Stations

Use Simultaneous Stations to set the maximum number of stations the RXC will activate at the same time. The number of stations includes the master valve or pump if being used. Maximum of 3 stations or 2 stations and a master valve/pump can be set to run simultaneously.

**Note:** Maximum stations output should not exceed the maximum output current of 0.8 Amps.

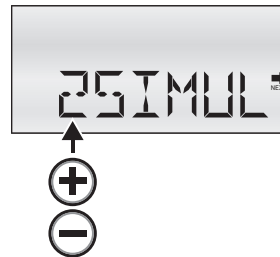

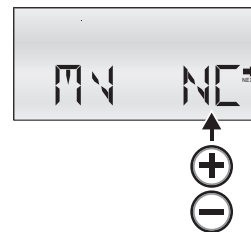

### Master Valve Type

Master valves comes in two types, normally closed (NC) or normally open (NO). Select the type of master valve that is installed in the system using the  button to switch NC and NO.



### Station Delay

Station delay is the time duration between the end of a station activation and the start of another station activation. This is used to allow the water system to re-pressurize or allow the water supply well to reach proper volume. To set the station delay, use the  or  button to set the desired delay in seconds, minutes and/or hours.

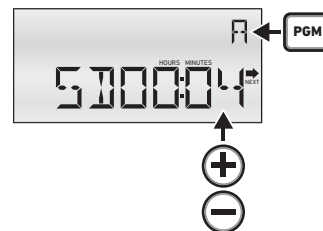

### Station Delay Active for Master Valve

Set to OFF if the master valve needs to be active during station delays or ON if master valve is also off during station delays. Use the **+** or **-** button to set SDMV to OF (MV is active during station delays) or ON (MV is off during station delays).

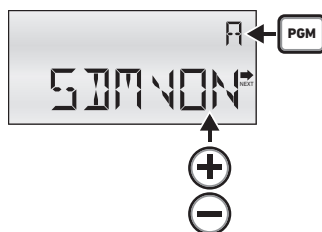

### Clock Settings

Change the clock format by pressing the **+** button to switch between 12-Hour and 24-Hour format.

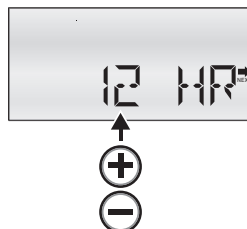

### Dry Out Days

DRY refers to the Dry Out Days after the rain sensor is triggered by a rain event. Use the **+** or **-** button to set DRY days from 0-3 days. The RXC will use this number to suspend irrigation after the rain sensor dries out.

### FW (Firmware) Version

Navigate to this screen to review the Firmware version of your RXC controller.



### Wi-Fi Module

Displays the Wi-Fi module's firmware version if Wi-Fi module is installed, .



### Activate Bluetooth Pairing

While on the **BLUETOOTH - HOLD RIGHT** screen, press and hold the **➤** button to enable/activate Bluetooth pairing mode. Pairing can also be activated by removing and reinstalling the Wi-Fi module.

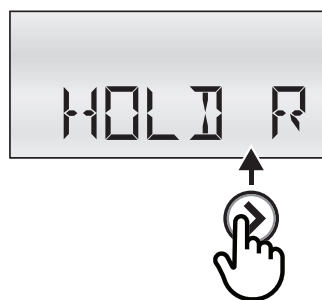

### Clear Wi-Fi

Use to clear Wi-Fi and reestablish Wi-Fi connection.

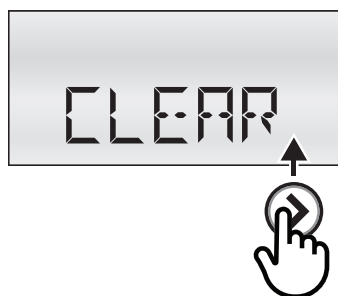

## SPECIAL SETTINGS

### Master Valve On/Off per Station

Use this menu setting to activate or deactivate the master valve for a specific station. Program default will have the master valve active (ON) for all stations.

1. Place the control dial to the **RUN TIMES**  position.
2. Simultaneously press the **+** and **-** or **←** and **→** button to access Master Valve ON/OFF per Station menu.
3. Use the **←** or **→** button to select the desired station to modify.
4. Use the **+** or **-** button to activate (ON) or deactivate (OFF) the master valve for the selected station.
5. Repeat Steps 2-4 to modify additional station(s).
6. Return the control dial to **AUTO**.

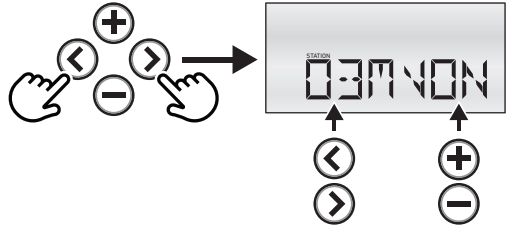

### Clear SETTINGS to Factory Default

Use this menu setting to reset all **SETTINGS** parameters back to factory default.

1. Place the control dial to the **SETTINGS**  position.
2. Simultaneously press the **+** and **-** or **←** and **→** button to access CLEAR menu.
3. Press the **→** button to activate **CLEAR**.
4. At the **OK?** screen prompt, press the **→** button again to accept.
6. Return the control dial to **AUTO**.

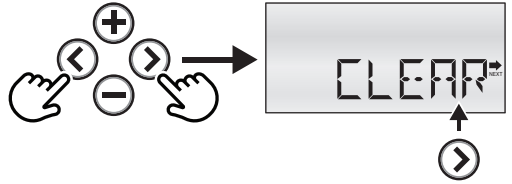

## Manual Operation

The RXC controller can run stations or programs within the MANUAL dial position without affecting normally programmed irrigation.

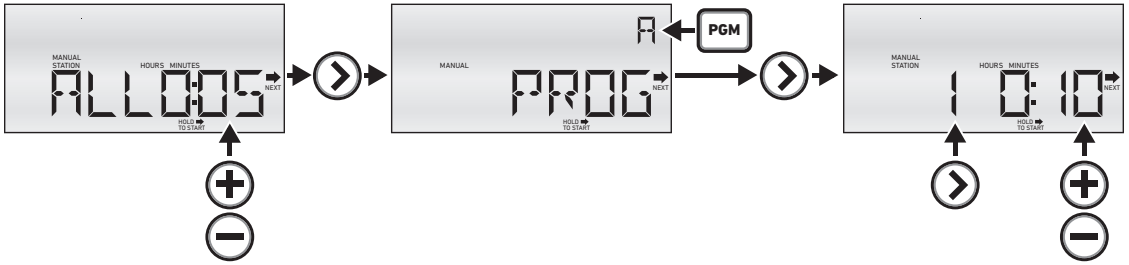

### Manually Activate All Stations

Use this function to activate all assigned stations (stations with a run time) to the RXC controller. Use the **+** or **-** button cycle to set the run time for each stations. Press the **➡** button to activate.

### Manually Activate a Program

Use the **PGM** button to select the program you want to start manually. Press and hold the **➡** button to start the program.

### Manually Activate Station(s)

Press the **➡** button to navigate to the manual station operation. Use the **+** or **-** button to set the amount run time. Use the **➡** button to navigate to the next station. Repeat this process for all desired stations manually. Press and hold the **➡** button to activate the selected stations.

## Rain Delay

You can pause operation to the RXC controller during rainy seasons or in any event that controller operation has to stop. Pressing the ON/OFF, RAIN DELAY **ON/OFF** button once will turn off automatic irrigation indefinitely. The rain delay symbol **☔** will be displayed on the screen to indicate that automatic irrigation is paused. Pressing the ON/OFF, RAIN DELAY **ON/OFF** button again will cancel rain delay and automatic irrigation will resume.

While the RXC is OFF, press the **+** or **-** button to set a specific number of day(s) to pause automatic irrigation. Once the set number of pause day(s) has been reached, automatic irrigation will resume. If you want to cancel rain delay before the set number of pause day(s) is reached, simply press the ON/OFF, RAIN DELAY **ON/OFF** button and rain delay will be canceled and automatic irrigation will resume.

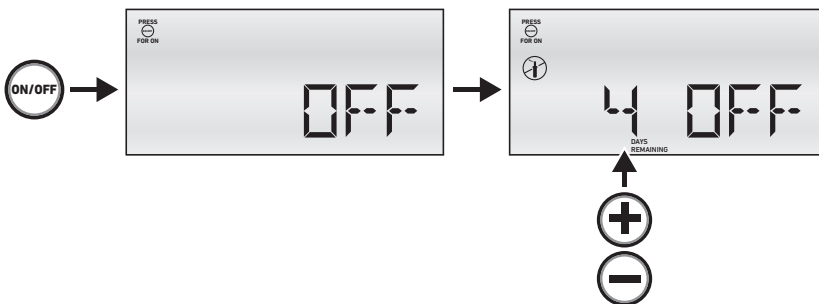

## Firmware Update

The RXC controller's firmware can be updated using the Toro Oasis Irrigation Management application. Download the Toro Oasis irrigation management application using your smart device's App Store. The RXC controller requires the RXC Wi-Fi module (RXC-WIFI) in order to pair with the Toro Oasis App. The RXC-WIFI module is sold separately.



Scan QR Code for  
Apple Devices



Scan QR Code for  
Android Devices

## Warnings and Alerts

The RXC controller is capable to sensing faults in the system. When RXC encounters a fault, the red LED door indicator will illuminate and the LCD will indicate what fault RXC encountered. Listed below are the alerts and warnings that RXC may encounter.

RR IN

Rain alert indicates that the rain sensor has been triggered.

SHORT

time as scheduled.

Short Circuit alert indicates that RXC detected a short circuit among the station(s). When a short circuit is detected, RXC will prevent activation of the affected station(s). RXC will still count down the allotted station run

OPEN

Open Circuit alert indicates that RXC detected an open circuit among the station(s). Open circuit detection does not affect scheduled watering.

OVFL

allotted station run

time as scheduled. Overflow alert indicates that the detected flow rate at the flow sensor exceeds above the maximum expected flow rate. When an overflow is detected, RXC will prevent activation of the affected station(s). RXC will still count down the

UNFL

allotted station run

time as scheduled. Underflow alert indicates that the detected flow rate at the flow sensor is below the minimum expected flow rate. When an underflow is detected, RXC will prevent activation of the affected station(s). RXC will still count down the

UNEXFL

Unexpected flow alert indicates that RXC detected flow during non-operation. When unexpected flow is detected, RXC will suspend all automatic watering.

## Product Accessories

**RXC 4-Station Expansion Module:** Part Number RXC4-MOD

**RXC Flow Module:** Part Number RXC-FLOW

**RXC Wi-Fi Module:** Part Number RXC-WIFI

## Specifications

### Power Specifications:

- **Input:** 120 VAC, 60 Hz, 0.3 A
- **Output:** 24 VAC, 0.8 A Total (Maximum 3 stations ON)

### Temperature Range:

- **Operating:** 32°F to +140°F (0°C to +60°C)
- **Storage:** 14°F to +149°F (-10°C to +60°C)
- **Relative Humidity:** 90%

## FCC/IC Statement

RXC may be provided with an optional modular approval with FCC ID: 2AC7Z-ESPC3MINI1 and IC: 21098-ESPC3MINI1

This device complies with Part 15 of the FCC Rules. Operation is subject to the following two conditions: (1) this device may not cause harmful interference, and (2) this device must accept any interference received, including any interference that may cause undesired operation.

**WARNING:** The Federal Communications Commission warns that changes or modifications of the radio module within this device not expressly approved by The Toro Company could void the user's authority to operate the equipment.

**NOTE:** This equipment has been tested and found to comply with the limits for a Class B digital device, pursuant to part 15 of the FCC Rules. These limits are designed to provide reasonable protection against harmful interference in a residential installation. This equipment generates, uses and can radiate radio frequency energy and, if not installed and used in accordance with the instructions, may cause harmful interference to radio communications. However, there is no guarantee that interference will not occur in a particular installation.

If this equipment does cause harmful interference to radio or television reception, which can be determined by turning the equipment off and on, the user is encouraged to try to correct the interference by one or more of the following measures:

- Reorient or relocate the receiving antenna.
- Increase the separation between the equipment and receiver.
- Connect the equipment into an outlet on a circuit different from that to which the receiver is connected.
- Consult the dealer or an experienced radio/TV technician for help.

### ICES-003B/NMB-003B

This device complies with Industry Canada license-exempt RSS standard(s). Operation is subject to the following two conditions: (1) this device may not cause interference, and (2) this device must accept any interference, including interference that may cause undesired operation of the device.

Le présent appareil est conforme aux CNR d'Industrie Canada applicables aux appareils radio exempts de licence. L'exploitation est autorisée aux deux conditions suivantes : (1) l'appareil ne doit pas produire de brouillage, et (2) l'utilisateur de l'appareil doit accepter tout brouillage radioélectrique subi, même si le brouillage est susceptible d'en compromettre le fonctionnement.

**⚠ WARNING:** Cancer and Reproductive harm – [www.P65Warnings.ca.gov](http://www.P65Warnings.ca.gov).

For more information, please visit [The Toro Company's Product Safety Page](#).

**Patent:** [www.ttcopats.com](http://www.ttcopats.com)