



Groundsmaster[®] 3500-D

Groundsmaster Traction Unit

Model No. 30821—Serial No. 22000001 and Up

Operator's Manual





Warning



CALIFORNIA

Proposition 65 Warning

Diesel engine exhaust and some of its constituents are known to the State of California to cause cancer, birth defects, and other reproductive harm.

Contents

	Page
Introduction	2
Safety	3
Safe Operating Practices	3
Toro Mower Safety	5
Sound Power Level	6
Sound Pressure Level	6
Vibration Level	7
Safety and Instruction Decals	7
Specifications	10
General Specifications	10
Optional Equipment	10
Setup	11
Loose Parts	11
Activating, Charging, and Connecting the Battery	11
Installing the Seat	13
Checking the Angle Indicator	14
Installing the Hood Latch (CE)	14
Installing the Exhaust Guard (CE)	14
Adjusting the Lift Arms	15
Rear Ballast	16
Before Operating	16
Checking the Crankcase Oil	16
Filling the Fuel Tank	16
Checking the Cooling System	17
Checking the Hydraulic System	17
Checking the Tire Pressure	18
Checking the Torque of the Wheel Nuts	18
Operation	19
Controls	19
Starting and Stopping the Engine	21
Bleeding the Fuel System	21
Checking the Interlock System	22
Towing the Traction Unit	22
Operating Characteristics	23

	Page
Maintenance	26
Recommended Maintenance Schedule	26
Daily Maintenance Checklist	27
Greasing the Bearings and Bushings	28
Removing the Hood	30
Servicing the Air Cleaner	30
Servicing the Engine Oil and Filter	31
Servicing the Fuel System	32
Bleeding Air from the Injectors	33
Cleaning the Engine Cooling System	33
Servicing the Engine Belts	34
Adjusting the Throttle	34
Changing the Hydraulic Fluid	35
Replacing the Hydraulic Filter	35
Checking the Hydraulic Lines and Hoses	36
Adjusting the Traction Drive for Neutral	36
Adjusting the Parking Brake	37
Caring for the Battery	37
Storing the Battery	37
Fuses	37
Electrical Schematic	38
Hydraulic Schematic	39
Preparation for Seasonal Storage	40
The Toro General Commercial Products Warranty ..	44

Introduction

Read this manual carefully to learn how to operate and maintain your product properly. The information in this manual can help you and others avoid injury and product damage. Although Toro designs and produces safe products, you are responsible for operating the product properly and safely.

Whenever you need service, genuine Toro parts, or additional information, contact an Authorized Service Dealer or Toro Customer Service and have the model and serial numbers of your product ready. The two numbers are stamped into a plate located on the frame of the mower.

Write the product model and serial numbers in the space below:

Model No. _____
Serial No. _____

This manual identifies potential hazards and has special safety messages that help you and others avoid personal injury and even death. **Danger**, **Warning**, and **Caution** are signal words used to identify the level of hazard. However, regardless of the hazard, be extremely careful.

Danger signals an extreme hazard that *will* cause serious injury or death if you do not follow the recommended precautions.

Warning signals a hazard that *may* cause serious injury or death if you do not follow the recommended precautions.

Caution signals a hazard that may cause minor or moderate injury if you do not follow the recommended precautions.

This manual uses two other words to highlight information.

Important calls attention to special mechanical information and **Note**: emphasizes general information worthy of special attention.

Safety

This machine meets or exceeds CEN standard EN 836:1997, ISO standard 5395:1990, and ANSI B71.4-1999 specifications in effect at the time of production.

Improper use or maintenance by the operator or owner can result in injury. To reduce the potential for injury, comply with these safety instructions and always pay attention to the safety alert  symbol, which means CAUTION, WARNING, or DANGER—“personal safety instruction.” Failure to comply with the instruction may result in personal injury or death.

Safe Operating Practices

The following instructions are from the CEN standard EN 836:1997, ISO standard 5395:1990, and ANSI standard B71.4-1999.

Training

- Read the Operator’s Manual and other training material carefully. Be familiar with the controls, safety signs, and the proper use of the equipment.
- Never allow children or people unfamiliar with these instructions to use the mower. Local regulations may restrict the age of the operator.
- Never mow while people, especially children, or pets are nearby.
- Keep in mind that the operator or user is responsible for accidents or hazards occurring to himself or herself, other people, or property.
- Do not carry passengers.
- All drivers and mechanics should seek and obtain professional and practical instruction. The owner is responsible for training the users. Such instruction should emphasize:
 - the need for care and concentration when working with ride-on machines;
 - control of a ride-on machine sliding on a slope will not be regained by the application of the brake. The main reasons for loss of control are:
 - insufficient wheel grip;
 - being drive too fast;
 - inadequate braking;
 - the type of machine is unsuitable for its task;
 - lack of awareness of the effect of ground conditions, especially slopes;
 - incorrect hitching and load distribution.

Preparation

- While mowing, always wear substantial footwear, long trousers, hard hat, safety glasses, and ear protection. Long hair, loose clothing or jewelry may get tangled in moving parts. Do not operate the equipment when barefoot or wearing open sandals.
- Thoroughly inspect the area where the equipment is to be used and remove all objects which may be thrown by the machine.
- **Warning**—fuel is highly flammable. Take the following precautions:
 - Store fuel in containers specifically designed for this purpose.
 - Refuel outdoors only and do not smoke while refuelling.
 - Add fuel before starting the engine. Never remove the cap of the fuel tank or add fuel while the engine is running or when the engine is hot.
 - If fuel is spilled, do not attempt to start the engine but move the machine away from the area of spillage and avoid creating any source of ignition until fuel vapors have dissipated.
 - Replace all fuel tank and container caps securely.
- Replace faulty silencers/mufflers.
- Before using, always visually inspect to see that the blades, blade bolts, and cutting assembly are not worn or damaged. Replace worn or damaged blades and bolts in sets to preserve balance.
- On multi-bladed machines, take care as rotating one blade can cause other blades to rotate.

- Evaluate the terrain to determine what accessories and attachments are needed to properly and safely perform the job. Only use accessories and attachments approved by the manufacturer.
- Check that operator's presence controls, safety switches, and shields are attached and functioning properly. Do not operate unless they are functioning properly.

Operation

- Do not operate the engine in a confined space where dangerous carbon monoxide fumes can collect.
- Mow only in daylight or in good artificial light.
- Before attempting to start the engine, disengage all blade attachment clutches, shift into neutral, and engage the parking brake. Only start the engine from the operator's position. Use seat belts, if provided.
- Do not use on slopes of more than
 - 25° when mowing on side hills;
 - 10° when mowing uphill;
 - 15° when mowing downhill.
- Remember there is no such thing as a safe slope. Travel on grass slopes requires particular care. To guard against overturning:
 - Do not stop or start suddenly when going up or downhill.
 - Engage the clutch slowly, always keep the machine in gear, especially when travelling downhill.
 - The machine speed should be kept low on slopes and during tight turns.
 - Stay alert for humps and hollows and other hidden hazards.
 - Never mow across the face of the slope, unless the machine is designed for that purpose.
- Stay alert for holes in the terrain and other hidden hazards.
- Use care when pulling loads or using heavy equipment.
 - Use only approved drawbar hitch points.
 - Limit loads to those you can safely control.
 - Do not turn sharply. Use care when reversing.
 - Use counterweight(s) or wheel weights when suggested in the operator's manual.
- Watch out for traffic when crossing or near roadways.
- Stop the blades rotating before crossing surfaces other than grass.
- When using any attachments, never direct discharge of material toward bystanders nor allow anyone near the machine while in operation.
- Never operate the machine with damaged guards, shields, or without safety protective devices in place. Be sure all interlocks are attached, adjusted properly, and functioning properly.
- Do not change the engine governor settings or overspeed the engine. Operating the engine at excessive speed may increase the hazard of personal injury.
- Before leaving the operator's position:
 - Stop on level ground.
 - Disengage the power take-off and lower the attachments.
 - Change into neutral and set the parking brake.
 - Stop the engine and remove the key.
- Disengage drive to attachments, stop the engine, and disconnect the spark plug wire(s) or remove the ignition key:
 - before clearing blockages;
 - before checking, cleaning, or working on the machine;
 - after striking a foreign object. Inspect the machine for damage and make repairs before restarting and operating the equipment;
 - if the machine starts to vibrate abnormally (check immediately).
- Disengage drive to attachments when transporting or not in use.
- Stop the engine and disengage drive to attachment:
 - before refuelling;
 - before making height adjustment unless adjustment can be made from the operator's position.
- Reduce the throttle setting during engine run-out and, if the engine is provided with a shut-off valve, turn the fuel off at the conclusion of mowing.
- Never raise deck with the blades running.
- Keep hands and feet away from the cutting units.
- Look behind and down before backing up to be sure of a clear path.
- Slow down and use caution when making turns and crossing roads and sidewalks.
- Do not operate the mower under the influence of alcohol or drugs.
- Use care when loading or unloading the machine into a trailer or truck.

- The operator shall turn on flashing warning lights, if provided, whenever traveling on a public road, except where such use is prohibited by law.

Maintenance and Storage

- Keep all nuts, bolts, and screws tight to be sure the equipment is in safe working condition.
- Never store the equipment with fuel in the tank inside a building where fumes may reach an open flame or spark.
- Allow the engine to cool before storing in any enclosure and do not store near flame.
- To reduce the fire hazard, keep the engine, silencer/muffler, battery compartment, cutting units, drives, and fuel storage area free of grass, leaves, or excessive grease. Clean up oil or fuel spillage.
- Replace worn or damaged parts for safety.
- If the fuel tank has to be drained, do this outdoors.
- On multi-bladed machines, take care as rotating one blade can cause other blades to rotate.
- When machine is to be parked, stored, or left unattended, lower the cutting units unless a positive mechanical lock is provided.
- Disengage drives, lower the cutting units, move traction pedal to Neutral, set parking brake, stop engine and remove key and disconnect spark plug wire. Wait for all movement to stop before adjusting, cleaning or repairing.
- Shut off fuel while storing or transporting. Do not store fuel near flames.
- Park machine on level ground. Never allow untrained personnel to service machine.
- Use jack stands to support components when required.
- Carefully release pressure from components with stored energy.
- Disconnect battery or remove spark plug wire before making any repairs. Disconnect the negative terminal first and the positive last. Reconnect positive first and negative last.
- Use care when checking blades. Wrap the blades or wear gloves, and use caution when servicing them. Only replace blades. Never straighten or weld them.
- Keep hands and feet away from moving parts. If possible, do not make adjustments with the engine running.



- Charge batteries in an open well ventilated area, away from spark and flames. Unplug charger before connecting or disconnecting from battery. Wear protective clothing and use insulated tools.

Toro Mower Safety

The following list contains safety information specific to Toro products or other safety information that you must know that is not included in the CEN, ISO, or ANSI standards.

This product is capable of amputating hands and feet and throwing objects. Always follow all safety instructions to avoid serious injury or death.

Use of this product for purposes other than its intended use could prove dangerous to user and bystanders.

	Warning	
<p>Engine exhaust contains carbon monoxide, which is an odorless, deadly poison that can kill you.</p> <p>Do not run engine indoors or in an enclosed area.</p>		

Preparation

- Be sure to establish your own special procedures and work rules for unusual operating conditions (E.G. slopes too steep for operation). **Survey the complete mowing site to determine which hills can be safely operated on.** When performing this site survey, always use common sense and take into consideration the turf condition and the rollover risk. To determine which hills or slopes may be safely operated on, use the inclinometer provided with each machine. To perform a site survey, follow the procedure outlined in the Operation section of the this manual. **The maximum side hill angle should not be greater than 25 degrees.**

Training

- The operator must be skilled and trained in how to drive on hillsides. Failure to use caution on slopes or hills may cause the vehicle to tip or roll, possibly resulting in personal injury or death.

Operation

- Know how to stop the machine and engine quickly.
- Do not operate the machine while wearing tennis shoes or sneakers.

- Wearing safety shoes and long pants is advisable and required by some local ordinances and insurance regulations.
- Keep hands, feet, and clothing away from moving parts and the mower discharge area.
- Fill fuel tank until level is 1 in. (25 mm) below the bottom of the filler neck. Do not overfill.
- Check the safety interlock switches daily for proper operation. If a switch should fail, replace the switch before operating the machine. After every two years, replace all interlock switches in the safety system, **regardless** if they are working properly or not.
- When starting the engine, engage the parking brake, put the traction pedal in neutral, and disengage the blade drive. After the engine starts, release the parking brake and keep your foot off of the traction pedal. The machine must not move. If movement is evident, refer to the Maintenance section of this manual to adjust the traction drive.
- Use extreme caution when operating close to sand traps, ditches, creeks, steep hillsides, or other hazards.
- Reduce speed when making sharp turns.
- Do not turn on hills.
- Do not operate on a side hill that is too steep. A rollover may occur before losing traction.
- The slope angle at which the machine will tip is dependent on many factors. Among these are mowing conditions such as wet or undulating turn, speed (especially in turns), position of the cutting units (with the Sidewinder), tire pressure, and operator experience. At side hill angles of 20 degrees or less, the risk of a rollover is low. As the slope angle increases to a recommended maximum limit of 25 degrees, the risk of a rollover increases to a moderate level. *Do not exceed a 25 degree side hill slope angle because the risk of a rollover and serious injury or death is very high.* The machine is equipped with an angle indicator mounted on the steering tube. This indicates the side hill angle the machine is on and identifies the recommended maximum limit of 25 degrees.
- For steering control, the cutting units must be lowered when going down slopes.
- Avoid sudden stops and starts.
- Use the reverse pedal for braking.
- Watch for traffic when near or crossing roads. Always yield the right-of-way.
- Raise the cutting units when driving from one work area to another.

- Do not touch the engine, muffler, exhaust pipe, or hydraulic tank while the engine is running or soon after it has stopped because these areas could be hot enough to cause burns.

Maintenance and Storage

- Before servicing or making adjustments, stop the engine and remove the ignition key.
- Ensure that the entire machine is properly maintained and in good operating condition. Frequently check all nuts, bolts, screws, and hydraulic fittings.
- Make sure all hydraulic line connectors are tight and all hydraulic hoses and lines are in good condition before applying pressure to the system.
- Keep your body and hands away from pin hole leaks or nozzles that eject hydraulic fluid under high pressure. Use paper or cardboard, not your hands, to search for leaks. Hydraulic fluid escaping under pressure can have sufficient force to penetrate the skin and cause serious injury. If fluid is injected into the skin it must be surgically removed within a few hours by a doctor familiar with this form of injury or gangrene may result.
- Before disconnecting or performing any work on the hydraulic system, all pressure in the system must be relieved by stopping the engine and lowering the cutting units to the ground.
- If the engine must be running to perform a maintenance adjustment, keep hands, feet, clothing, and any parts of the body away from the cutting units, attachments, and any moving parts. Keep everyone away.
- Do not overspeed the engine by changing governor settings. To ensure safety and accuracy, have an Authorized Toro Distributor check the maximum engine speed with a tachometer.
- The engine must be shut off before checking the oil or adding oil to the crankcase.
- If major repairs are ever needed or if assistance is desired, contact an Authorized Toro Distributor.
- To make sure of optimum performance and continued safety certification of the machine, use only genuine Toro replacement parts and accessories. Replacement parts and accessories made by other manufacturers could be dangerous, and such use could void the product warranty.

Sound Power Level

This unit has a guaranteed sound power level of 105 dBA, based on measurements of identical machines per Directive 2000/14/EC and amendments.

Sound Pressure Level

This unit has an equivalent continuous A-weighted sound pressure level at the operator ear of 89 dBA based on measurements of identical machines per Directive 98/37/EC and amendments

Vibration Level

This unit does not exceed a vibration level of 2.5 m/s² at the hands based on measurements of identical machines per ISO 5349 procedures.

This unit does not exceed a vibration level of 0.5 m/s² at the posterior based on measurements of identical machines per ISO 2631 procedures.

Safety and Instruction Decals



Safety decals and instructions are easily visible to the operator and are located near any area of potential danger. Replace any decal that is damaged or lost.

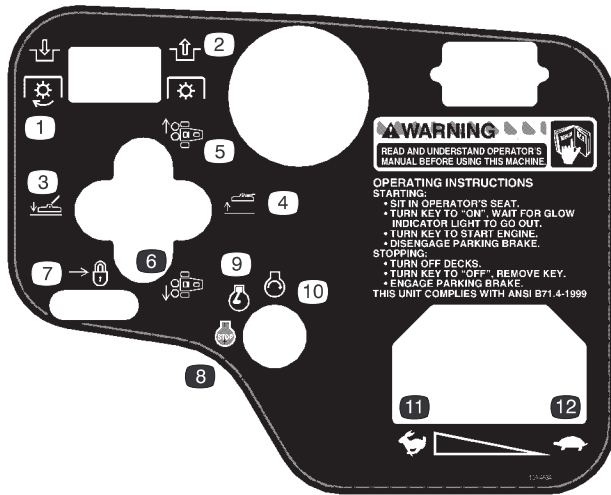

100-4837

- | | |
|------------------------------|--|
| 1. Engage cutting units | 7. Lock cutting units in raised position |
| 2. Disengage cutting units | 8. Engine stop |
| 3. Lower cutting units | 9. Engine on/preheat |
| 4. Raise cutting units | 10. Engine start |
| 5. Shift cutting units right | 11. Fast throttle |
| 6. Shift cutting units left | 12. Slow throttle |

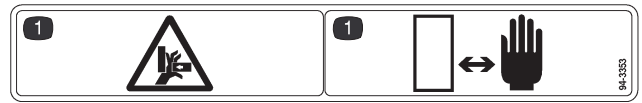

94-3353

1. Crushing hazard of fingers and hands—keep hands away.

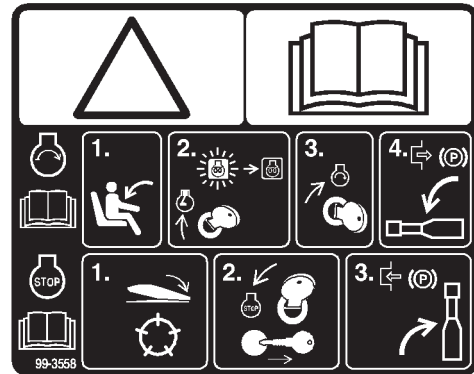

99-3558 (for CE)

1. Warning—read the operator's manual.
2. To start the engine, sit on the seat and rotate the ignition key to On/Preheat until the glow plug indicator light goes out. Rotate the key to start and disengage the parking brake. Read the operator's manual for further instructions.
3. To stop the engine, disengage the cutting units, rotate the ignition key to Off, and remove the key. Engage the parking brake. Read the operator's manual for further instructions.

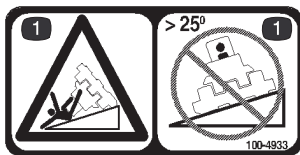

100-4933 (for CE)

1. Tipping hazard—do not operate across slopes greater than 25 degrees.



100-4837



100-6574

1. Hot surface hazard—stay away.
2. Cutting/dismemberment hazard and entanglement hazard—stay away from moving parts.

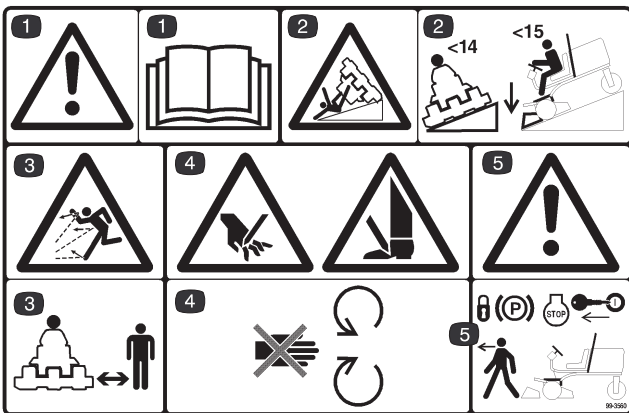

99-3560 (for CE)

1. Warning—read the operator's manual.
2. Tipping hazard—only operate on slopes less than 14 degrees or down slopes less than 15 degrees.
3. Thrown object hazard—keep bystanders away.
4. Cutting hazard of hands and feet—stay away from moving parts.
5. Warning—set the parking brake, stop the engine, and remove the ignition key before leaving the machine.



93-7276

1. Explosion hazard—wear eye protection.
2. Caustic liquid hazard—flush with water and get medical help fast.
3. Fire hazard—fire, open light, and smoking prohibited.
4. Toxic hazard—keep children away from the battery.

GROUNDMASTER 3500-D QUICK REFERENCE AID

CHECK/SERVICE (DAILY)

1. OIL LEVEL, ENGINE
2. ENGINE OIL DRAIN (24" OR 19mm SOCKET)
3. OIL LEVEL, HYDRAULIC TANK
4. COOLANT LEVEL, RADIATOR
5. FUEL/WATER SEPARATOR
6. AIR CLEANER
7. RADIATOR SCREEN
8. PARKING BRAKE
9. TIRE PRESSURE (14-18 psi)
10. BATTERY
11. BELTS (FAN, ALTERNATOR, HYDRAULIC PUMP)

GREASING - SEE OPERATOR'S MANUAL

FLUID SPECIFICATIONS/CHANGE INTERVALS

SEE OPERATOR'S MANUAL FOR INITIAL CHANGES	FLUID TYPE	CAPACITY	CHANGE INTERVAL	FILTER PART NO.	
A. ENGINE OIL	SAE 10W-30/CD	4.0 QTS.	50 HRS.	100 HRS.	99-8384
B. HYD. CIRCUIT OIL	MOBIL DTE15M	6 GAL.*	400 HRS.	200 HRS.	99-3010
C. AIR CLEANER			200 HRS.	400 HRS.	99-8763
D. FILTER, IN-LINE FUEL			400 HRS.	400 HRS.	98-7612
E. WATER SEPARATOR			400 HRS.	400 HRS.	98-9764
F. FUEL TANK	NO. 2-DIESEL	11 GALS.	DRAIN AND FLUSH, 2 YRS.		
G. COOLANT	50/50 ETHYLENE GLYCOL/WATER	6 QTS.	DRAIN AND FLUSH, 2 YRS.		

* INCLUDING FILTER

FUSE

- 15 A MAIN
- OPEN
- 5 A ENGINE
- 5 A ACC

100-0483

104-4864

DANGER

FAILURE TO COMPLY WITH THE FOLLOWING SAFETY REQUIREMENTS MAY RESULT IN PERSONAL INJURY OR DEATH. READ & UNDERSTAND OPERATOR'S MANUAL BEFORE OPERATING THIS MACHINE.

- THIS TRIPLEX MOWER HAS A UNIQUE DRIVE SYSTEM FOR SUPERIOR TRACTION ON HILLS.
- UPHILL WHEEL WILL NOT SPIN OUT AND LIMIT TRACTION LIKE CONVENTIONAL TRIPLEXES.
- IF OPERATED ON A SIDE HILL THAT IS TOO STEEP, ROLLOVER WILL OCCUR BEFORE LOSING TRACTION.

• USE EXTREME CAUTION ON HILLS, SLOPES, AND ROUGH TERRAIN.
 • DO NOT OPERATE ON ANY SIDEHILL UNTIL YOUR SUPERVISOR HAS COMPLETED A SITE SURVEY AS OUTLINED IN THE OPERATOR'S MANUAL.
 • ALWAYS FASTEN YOUR SEAT BELT.
 • WHEN POSSIBLE, MOW UP AND DOWN A HILL, RATHER THAN ACROSS IT. DO NOT TURN ON HILLS.
 • OPERATOR MUST BE SKILLED AND TRAINED IN SLOPE OPERATION.
 • AVOID SUDDEN STARTS, STOPS, HOLES, DROP OFFS, OR HIDDEN HAZARDS IN TERRAIN.
 • AVOID WET OR LOOSE TURF CONDITIONS THAT MAY CAUSE THE MACHINE TO SLIDE.
 • CUTTING UNITS MUST BE LOWERED WHEN GOING DOWN SLOPES FOR STEERING CONTROL.
 • ON SIDEHILLS, SHIFT CUTTING UNITS UPHILL (IF SO EQUIPPED).
 • FOR BRAKING, MOVE TRACTION PEDAL TO NEUTRAL OR DIRECTION OPPOSITE TRAVEL DIRECTION.
 • KEEP PEOPLE AND PETS AWAY FROM MACHINE.
 • STOP ENGINE BEFORE ADDING FUEL OR SERVICING MACHINE.
 • CHECK OPERATION OF ALL INTERLOCKS AND BRAKES DAILY.
 • DO NOT ALLOW OPERATION OF THIS MACHINE BY UNTRAINED PERSONNEL.

• KEEP ALL GUARDS IN PLACE.
 • BEFORE LEAVING OPERATOR'S POSITION: - SET PARKING BRAKE, TURN OFF ENGINE AND REMOVE KEY.

100-0481

104-0484

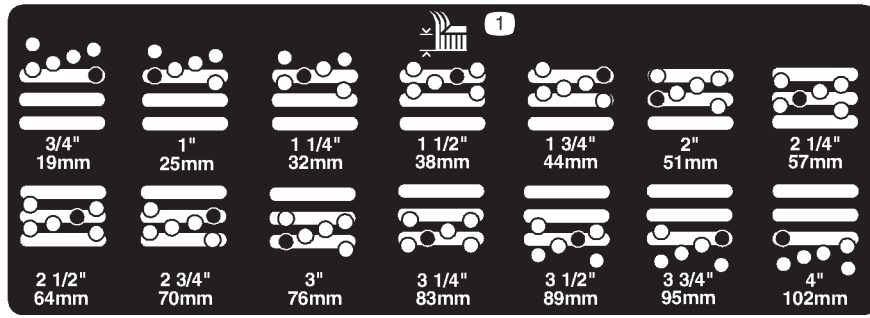

104-1086

1. Height of cut



43-8480

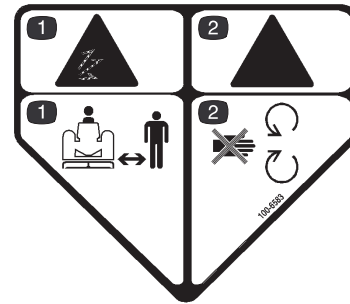

100-6583 (for CE)

1. Thrown object hazard—keep bystanders away.
2. Warning—stay away from rotating blades and moving parts.

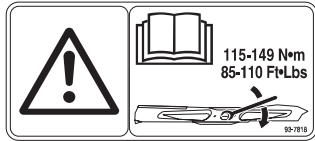

93-7818

1. Warning—read the operator's manual for blade torque instructions.

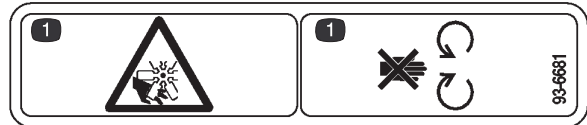

93-6681

1. Cutting/dismemberment hazard—stay away from moving parts.

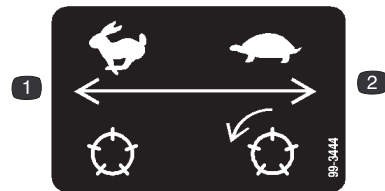

99-3444

1. Reel speed—fast
2. Reel speed—slow

Specifications

General Specifications

Engine	Kubota three-cylinder, 4-cycle liquid-cooled diesel engine. 32 hp @ 2800 RPM, governed to 3050 RPM. 68.5 cu. in. (1124 cc) displacement. Heavy-duty, 2-stage, remote mounted air cleaner. High water temperature shutdown switch.
Cooling system	Radiator capacity is approximately 6 qt. of 50/50 mixture of ethylene glycol anti-freeze. Remote mounted 1 qt. expansion tank.
Electrical	12 volt Group 55, 585 cold cranking amps at 0°F (-18°C), 95 minute reserve capacity at 80°F (27°C). 40 amp alternator with regulator/rectifier. Seat switch, PTO, parking brake and traction interlock switches.
Fuel capacity	11 gallons
Traction drive	High torque hydraulic wheel motors, 3-wheel drive, oil cooler and shuttle valve provide positive closed-loop cooling.
Hydraulic oil capacity/filter	Remote mounted, 3.5 gallon oil reservoir. 10 micron remote mounted spin on filter.
Ground speed	Infinitely variable speed selection in forward and reverse Mowing speed: 0–6 MPH (adjustable) Transport speed: 0–9 MPH Reverse speed: 0–3.5 MPH
Tires/wheels	Front tires are 20 x 12-10 and rear tires are 20 x 10-10 tubeless, 4-ply rating with demountable rims. Recommended tire pressure: 14–18 psi front and rear tires.
Frame	Tricycle vehicle with 3-wheel traction drive and rear wheel steering. Frame consists of formed steel, welded steel, and steel tubing components.
Steering	Power steering
Brakes	Service braking accomplished through dynamic characteristics of Hydrostat. Parking or emergency brake is actuated by over-center hand lever on the operator's right-hand side.
Controls	Foot operated forward and reverse traction pedals and mow/transport slide. Hand operated throttle, ignition switch, blade engagement switch, cutting unit lift, and shift lever, parking brake, and seat adjustment.
Gauges and protective systems	Hour meter, 4 light warning cluster gauge: oil pressure, water temperature, amps, glow plug, and side hill angle indicator.
Seat	Optional standard or deluxe seats
Cutting unit lift	Hydraulic lift with automatic shut off

Note: Specifications and design subject to change without notice.

Optional Equipment

Standard Seat	Model No. 03224
Deluxe Suspension Seat	Model No. 03225

Setup

Note: Determine the left and right sides of the machine from the normal operating position.

Loose Parts

Note: Use this chart as a checklist to ensure that all parts necessary for assembly have been received. Without these parts, total setup cannot be completed. Some parts may have already been assembled at the factory.

Description	Qty.	Use
Hood lock bracket	1	Mount to the hood for European compliance.
Screw, 1/4 x 1-1/2 in.	1	
Flat washer, 1/4 in.	1	
Locknut, 1/4 in.	1	
Exhaust guard	1	Mount to machine for European compliance.
Self-tapping screw	4	
Inclinometer	1	For site survey before operating the machine
EEC Decal	6	Affix to machine for European compliance.
Key	2	
EEC certificate	1	
Parts Catalog	1	
Operator's Manual	2	Read before operating the machine.
Engine manual	1	
Operator video	1	View before operating the machine.
Pre-delivery check list	1	Fill out before delivering to the customer.
Registration card	1	Fill out and return to Toro.

Activating, Charging, and Connecting the Battery

Warning

CALIFORNIA
Proposition 65 Warning

Battery posts, terminals, and related accessories contain lead and lead compounds, chemicals known to the State of California to cause cancer and reproductive harm. Wash hands after handling.

Note: If the battery is not filled with electrolyte or activated, bulk electrolyte with 1.260 specific gravity must be purchased from a local battery supply outlet and added to the battery.

Danger

Battery electrolyte contains sulfuric acid which is a deadly poison and causes severe burns.

- **Do not drink electrolyte and avoid contact with skin, eyes or clothing. Wear safety glasses to shield your eyes and rubber gloves to protect your hands.**
- **Fill the battery where clean water is always available for flushing the skin.**

1. Open the hood.

2. Remove the battery cover (Fig. 1).



Figure 1

1. Battery cover

3. Remove the filler caps from the battery and slowly fill each cell until electrolyte is just above the plates.
4. Install the filler caps and connect a 3 to 4 amp. battery charger to the battery posts. Charge the battery at a rate of 3 to 4 amperes for 4 to 8 hours.



Warning



Charging the battery produces gasses that can explode.

Never smoke near the battery and keep sparks and flames away from battery.

5. When the battery is charged, disconnect the charger from the electrical outlet and battery posts.
6. Remove the filler caps. Slowly add electrolyte to each cell until the level is up to the fill ring. Install the filler caps.

Important Do not overfill the battery. Electrolyte will overflow onto other parts of the machine and severe corrosion and deterioration will result.

7. Install the positive cable (red) to the positive (+) terminal and the negative cable (black) to the negative (-) terminal of the battery and secure them with capscrews and nuts (Fig. 2). Make sure that the positive (+) terminal is all of the way onto the post and the cable is positioned snug to the battery. The cable must not contact the battery cover. Slide the rubber boot over the positive terminal to prevent a possible short from occurring.



Warning



Incorrect battery cable routing could damage the tractor and cables causing sparks. Sparks can cause the battery gasses to explode, resulting in personal injury.

- Always *disconnect* the negative (black) battery cable before disconnecting the positive (red) cable.
- Always *connect* the positive (red) battery cable before connecting the negative (black) cable.

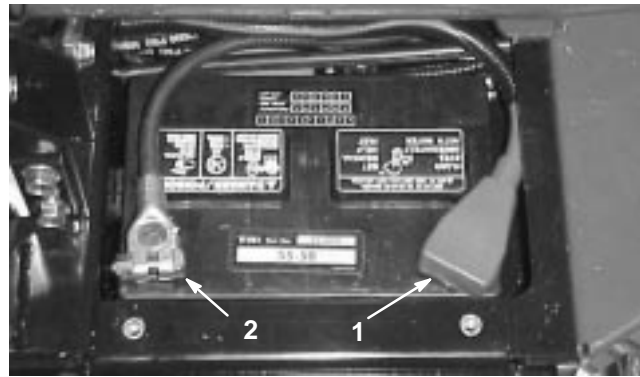

Figure 2

1. Positive (+) battery cable
2. Negative (-) battery cable

Important If the battery is ever removed, make sure that battery clamp bolts are reinstalled with the bolt heads positioned on the bottom side and the nuts on the top side. If the clamp bolts are reversed, they may interfere with the hydraulic tubes when shifting the cutting units.

8. Coat both battery connections with Grafo 112X (skin over) grease, Toro Part No. 505-47, petroleum jelly, or light grease to prevent corrosion. Slide the rubber boot over the positive terminal.
9. Install the battery cover.

Installing the Seat

The machine is shipped without the seat assembly. Deluxe Seat Kit, Model No. 03225 or Standard Seat Kit, Model No. 03224, must be installed as follows:

1. Remove the screws, washers, and spacers securing the seat mounting straps to the traction unit frame (Fig. 3).

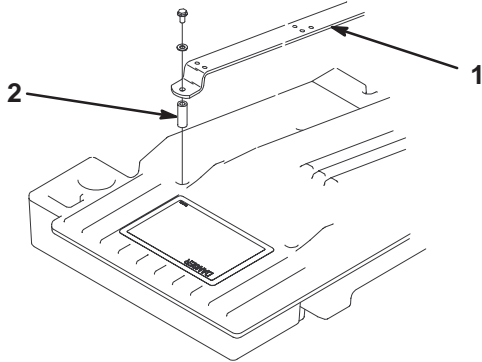

Figure 3

1. Seat mounting strap (2)
2. Spacer (2)

2. Secure the seat mounting straps to the seat adjusters with 4 flange nuts (standard seat) or 4 bolts, flat washers, and flange nuts (deluxe seat) (Fig. 4). The mounting fasteners are supplied with the seat kits.

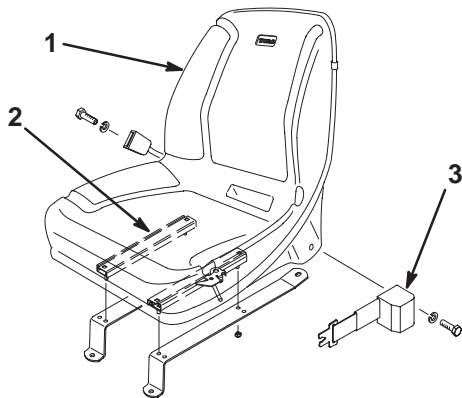

Figure 4

1. Standard seat
2. Seat adjusters
3. Seat belt

3. Attach the seat belt to the holes on each side of the seat with 2 bolts and lockwashers (standard seat) or 2 bolts and locknuts (deluxe seat) (Fig. 4). All mounting fasteners are supplied with the seat kits.
4. Position the seat and seat straps on the frame aligning mounting holes.
5. Route the seat switch wire under the right-hand seat strap and connect it to the appropriate seat switch connector on the wire harness.

6. On the deluxe seat only, route the unused seat switch connector back under the seat strap and secure both wires to the rear-most hole in the seat strap (Fig. 5) with a cable tie (cable tie supplied with seat kit).

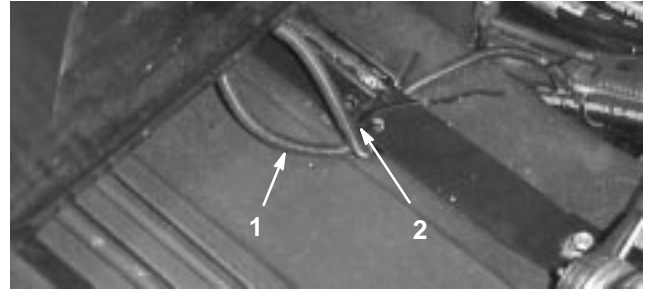

Figure 5

1. Seat switch wire
2. Cable tie

7. On the standard seat only, slide the seat all of the way forward, pull the wire to the right so that the unused connector is positioned as shown in Figure 6, and secure the seat switch wire to the rear-most hole in the seat strap with a cable tie (cable tie supplied with seat kit).



Figure 6

1. Seat switch wire
2. Cable tie

8. Mount the seat straps to the frame with the fasteners and spacers removed in step 1.
9. Slide the seat completely forward and backward to ensure proper operation and that the seat switch wires and connectors are not pinched or do no contact any moving parts.

Checking the Angle Indicator



Danger



To reduce risk of injury or death due to rollover, do not operate the machine on side hills steeper than 25°.

1. Park the machine on a flat, level surface.
2. Verify that the machine is level by placing a hand held inclinometer (supplied with the machine) on the frame cross rail, by the fuel tank (Fig. 7). The inclinometer should read zero degrees when viewed from the operator's position.

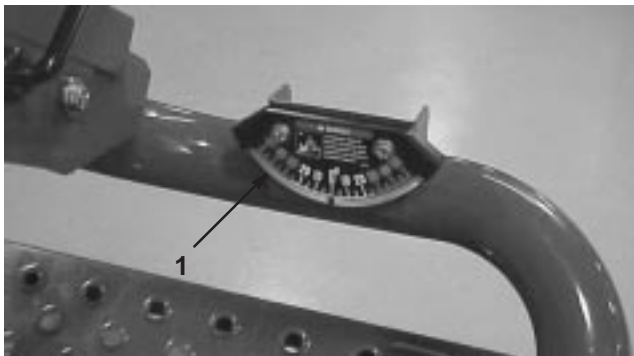

Figure 7

1. Angle indicator
-
3. If the inclinometer does not read zero degrees, move the machine to a location where a zero degree reading is obtained. The angle indicator, mounted on the machine, should now read zero degrees as well.
 4. If the angle indicator does not read zero degrees, loosen the two screws and nuts securing the angle indicator to the mounting bracket, adjust the indicator to obtain a zero degree reading, and tighten the capscrews.

Installing the Hood Latch (CE)

1. Unhook the hood latch from the hood latch bracket (Fig. 8).
2. Slide the hood lock bracket onto the latch (Fig. 8).
3. Hook the latch onto the hood latch bracket (Fig. 8).
4. Insert a bolt (1/4 x 1-1/2 in.) through the hood lock bracket and secure it with a flat washer and locknut (Fig. 8).

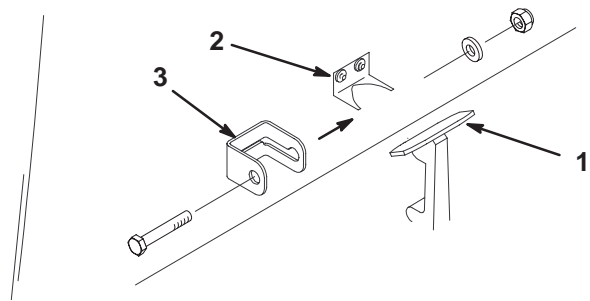

Figure 8

1. Hood latch
2. Hood latch bracket
3. Hood lock bracket

Installing the Exhaust Guard (CE)

1. Position the exhaust guard around the muffler while aligning the mounting holes with the holes in the frame (Fig. 9).
2. Secure the exhaust guard to the frame with 4 self-tapping screws (Fig. 9).

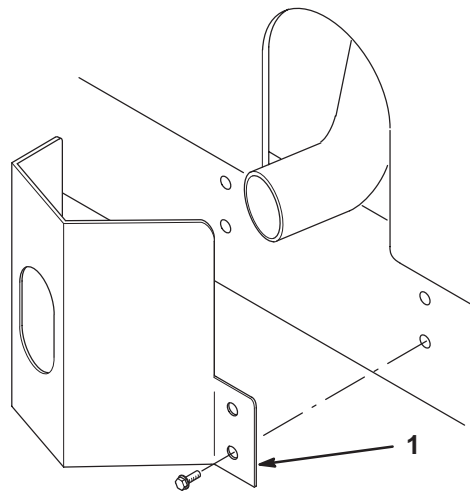

Figure 9

1. Exhaust guard

Adjusting the Lift Arms

1. Start the engine, raise the decks, and check to make sure that the clearance between each lift arm and the floor plate bracket is .18–.32 in. (5–8 mm) (Fig. 10). If the clearance is not in this range, back off the stop bolts (Fig. 11) and adjust the cylinder to attain clearance. To adjust the cylinder, back off the jam nut on the cylinder (Fig. 12), remove the pin from the rod end, and rotate the clevis. Install the pin and check the clearance. Repeat the procedure if required. Tighten the clevis jam nut.

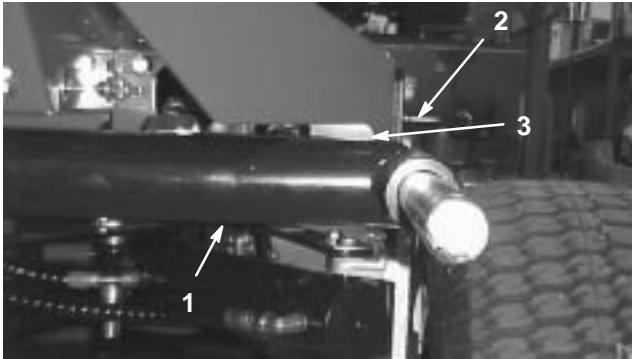

Figure 10

Decks removed for clarity

1. Lift arm
2. Floor plate bracket
3. Clearance

2. Check to make sure that the clearance between each lift arm and stop bolt is 0.005–0.040 in. (0.13–1.02 mm) (Fig. 11). If the clearance is not in this range, adjust the stop bolts to attain clearance.

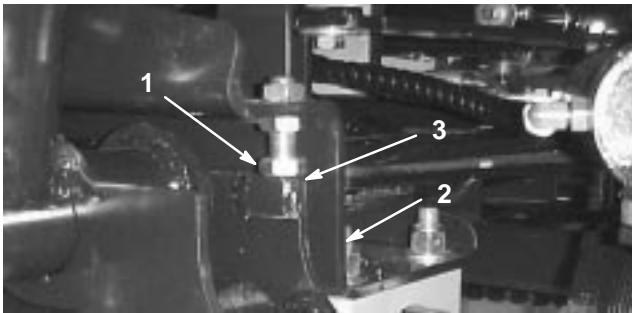

Figure 11

1. Stop bolt
2. Lift arm
3. Clearance

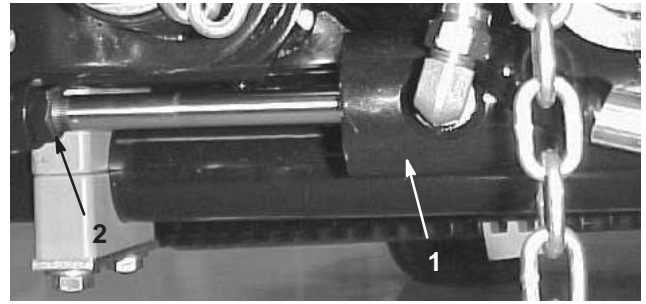

Figure 12

1. Front cylinder
2. Jam nut

3. Start the engine, raise the decks, and check to make sure that the clearance between the wear strap on the top of the rear cutting unit wear bar and the bumper strap is 0.02–0.10 in. (0.51–2.54 mm) (Fig. 13). If the clearance is not in this range, adjust the rear cylinder to attain clearance. To adjust the cylinder, lower the cutting units and back off the jam nut on the cylinder (Fig. 14). Grasp the cylinder rod close to the nut with a pliers and rag and rotate the rod. Raise the cutting units and check the clearance. Repeat the procedure if required. Tighten the clevis jam nut.

Note: If the rear lift arm “clunks” during transport, clearance can be reduced.



Figure 13

1. Wear bar
2. Bumper strap

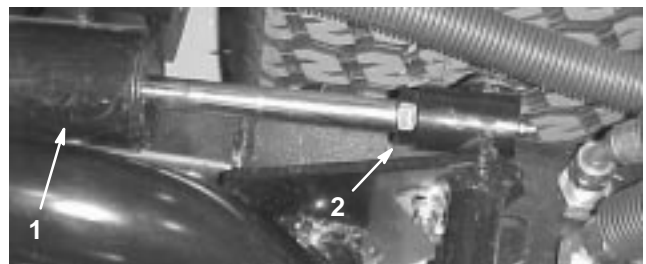

Figure 14

1. Rear cylinder
2. Adjusting nut

Important Lack of clearance at the front stops or rear wear bar could damage the lift arms.

Rear Ballast

The Groundsmaster 3500 Traction unit with 27" Rotary Cutting decks conforms to the B71.4-1999 standard when 50 lb. of calcium chloride ballast is added to the rear wheels.

Important If a puncture occurs in a tire with calcium chloride, remove the machine from the turf as quickly as possible. To prevent possible damage to the turf, immediately soak the affected area with water.

Before Operating



Caution



If you leave the key in the ignition switch, someone could accidentally start the engine and seriously injure you or other bystanders.

Remove the key from the ignition before you do any maintenance.

Checking the Crankcase Oil

The engine is shipped with oil in the crankcase; however, the oil level must be checked before and after the engine is first started.

Crankcase capacity is approximately 4 qt. (2.8 l) with the filter.

The engine uses any high-quality 10W30 detergent oil having the American Petroleum Institute (API) "service classification" CD, CE, CF, CF-4, or CG-4.

1. Position the machine on a level surface.
2. Remove the dipstick (Fig. 15) and wipe it with a clean rag. Push the dipstick down into the dipstick tube and make sure that it is seated fully. Pull the dipstick out and check the oil level. If the oil level is low, add enough oil to raise the level to the FULL mark on the dipstick.

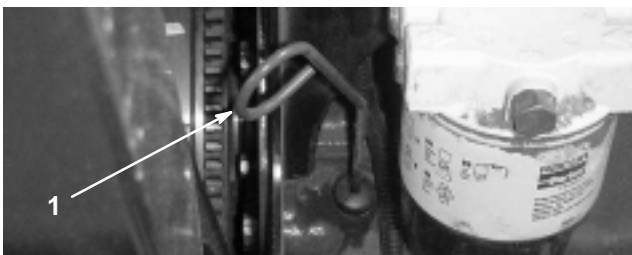

Figure 15

1. Dipstick

3. If the oil level is low, remove the oil fill cap (Fig. 16) and gradually add small quantities of oil, checking the level frequently, until the level reaches the FULL mark on the dipstick.

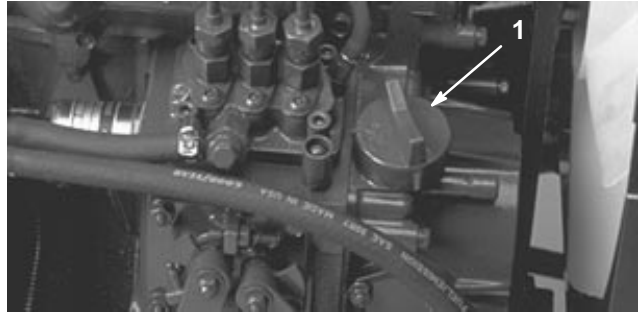

Figure 16

1. Oil fill cap

4. Install the oil fill cap and close the hood.

Important Check the oil level every 5 operating hours or daily. Change the oil after every 50 hours of operation.

Filling the Fuel Tank

The engine runs on No. 2 diesel fuel.

Fuel tank capacity is approximately 11 gallons.

1. Clean the area around the fuel tank cap (Fig. 17).

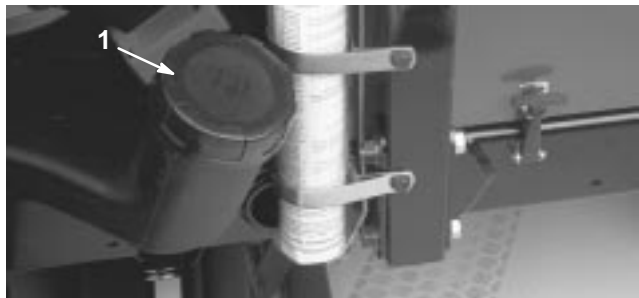

Figure 17

1. Fuel tank cap

2. Remove the fuel tank cap.
3. Fill the tank to the bottom of the filler neck. **Do not overfill.** Install the cap.
4. To prevent a fire hazard, wipe up any fuel that may have spilled.

Danger

Under certain conditions, diesel fuel and fuel vapors are highly flammable and explosive. A fire or explosion from fuel can burn you and others and can cause property damage.

- Use a funnel and fill the fuel tank outdoors, in an open area, when the engine is off and is cold. Wipe up any fuel that spills.
- Do not fill the fuel tank completely full. Add fuel to the fuel tank until the level is 1/4 to 1/2 in. (6 to 13 mm) below the bottom of the filler neck. This empty space in the tank allows the fuel to expand.
- Never smoke when handling fuel, and stay away from an open flame or where fuel fumes may be ignited by a spark.
- Store fuel in a clean, safety-approved container and keep the cap in place.

Caution

If the engine has been running, the pressurized, hot coolant can escape and cause burns.

- Do not open the radiator cap when the engine is running.
- Use a rag when opening the radiator cap, and open the cap slowly to allow steam to escape.

1. Check the coolant level in the expansion tank (Fig. 19). With a cold engine, the coolant level should be approximately midway between the marks on the side of the tank.
2. If the coolant level is low, remove the expansion tank cap and replenish the system. **Do not overfill.**
3. Install the expansion tank cap.

Checking the Cooling System

Clean debris off of the radiator and oil cooler daily (Fig. 18). Clean the radiator hourly if conditions are extremely dusty and dirty; refer to Cleaning the Engine Cooling System, page 33.

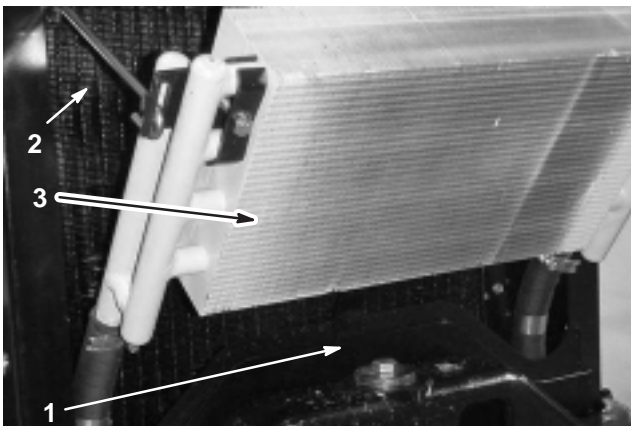

Figure 18

- | | |
|-----------------|---------------|
| 1. Access panel | 3. Oil cooler |
| 2. Radiator | |

The cooling system is filled with a 50/50 solution of water and permanent ethylene glycol anti-freeze. Check the coolant level at the beginning of each day before starting the engine.

The capacity of the cooling system is approximately 6 U.S. quarts (5.7 l).

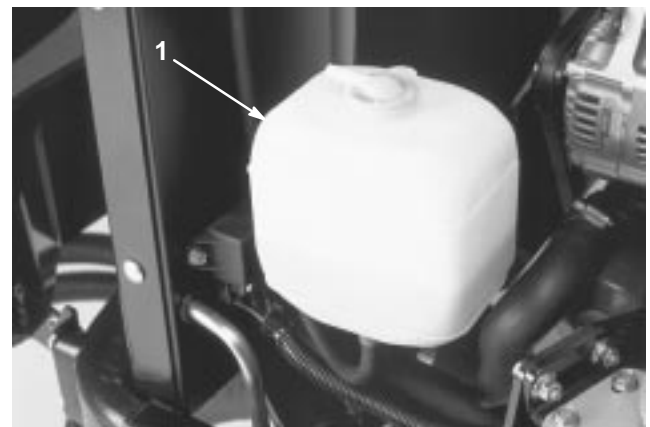

Figure 19

1. Expansion tank

Checking the Hydraulic System

The hydraulic system driving the decks is designed to operate on anti-wear hydraulic fluid. The hydraulic reservoir is filled at the factory with approximately 3.5 U.S. gallons (13.2 l) of high quality hydraulic fluid. **Check the hydraulic fluid level before the engine is first started and daily thereafter.**

The following list is not assumed to be all-inclusive. Hydraulic fluids produced by other manufacturers may be used if they can cross reference to find an equivalent to the products listed. Toro will not assume responsibility for damage caused by improper substitutions, so use only products from reputable manufacturers who will stand behind their recommendation.

Multigrade Hydraulic Fluid – ISO VG 46

Normal Climate: 0°F (–18°C) to 110°F (43°C)

Mobil	DTE 15M
Amoco	Rykon Premium ISO 46
Chevron	Rykon Premium Oil ISO 46
Conoco	Hydroclear AW MV46
Exxon	Univis N 46
Pennzoil	AWX MV46
Shell	Tellus T 46
Texaco	Rando HDZ 46

Important The ISO VG 46 Multigrade fluid has been found to offer optimal performance in a wide range of temperature conditions. For operation in consistently high ambient temperatures, 65°F (18°C) to 120°F (49°C), ISO VG 68 hydraulic fluid may offer improved performance.

Note: Many hydraulic fluids are almost colorless, making it difficult to spot leaks. A red dye additive for the hydraulic system oil is available in 2/3 oz. (20 ml) bottles. One bottle is sufficient for 4–6 gal (15–22 l) of hydraulic oil. Order part no. 44–2500 from your authorized Toro distributor. Not recommended for biodegradable fluid (use food coloring).

Biodegradable Hydraulic Fluid – Mobil 224H

Important Mobil EAL 224H is the only biodegradable oil tested and approved by Toro. Contamination by mineral-based hydraulic fluids will change the biodegradability and toxicity of this oil. When changing from standard fluid to the biodegradable type, be certain to follow the approved flushing procedure published by Mobil. Contact your local Toro Distributor for details. This oil is available in 5 gallon (19 l) containers from your Toro Distributor, order part no. 100–7674.

1. Position the machine on a level surface, lower the cutting units, and stop the engine.
2. Clean the area around the filler neck and cap of the hydraulic tank (Fig. 20). Remove the cap.

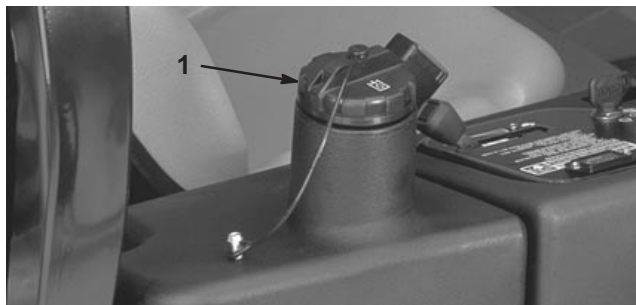

Figure 20

1. Hydraulic tank cap

3. Remove the dipstick from the filler neck and wipe it with a clean rag. Insert the dipstick into the filler neck; then remove it and check the fluid level. The fluid level should be within 1/4 inch (6 mm) of the mark on the dipstick.
4. If the level is low, add the appropriate fluid to raise the level to the full mark.
5. Install the dipstick and cap onto the filler neck.

Checking the Tire Pressure

The tires are over-inflated for shipping. Therefore, release some of the air to reduce the pressure. The correct air pressure in the tires is 14–18 psi (97–124 kPa).

Important Maintain the recommended pressure in all tires to ensure a good quality of cut and proper machine performance.

Danger

Low tire pressure decreases machine side hill stability. This could cause a rollover, which may result in personal injury or death.

Do not under-inflate the tires.

Checking the Torque of the Wheel Nuts

Warning

Failure to maintain proper torque of the wheel nuts could result in personal injury.

Torque the wheel nuts to 45–65 ft.-lb. (61–88 N·m) after 1–4 hours of operation and again after 10 hours of operation. Torque every 200 hours thereafter.

Operation

Note: Determine the left and right sides of the machine from the normal operating position.

! **Caution** !

This machine produces sound levels in excess of 85 dBA at the operators ear and can cause hearing loss through extended periods of exposure.

Wear hearing protection when operating this machine.

Controls

Traction Pedals

Depress the traction forward pedal (Fig. 21) to move forward. Depress traction reverse pedal (Fig. 21) to move backward or to assist in stopping when moving forward. Also, allow the pedal to move or move it to the neutral position to stop the machine.

Mow/Transport Slide

Using your heel, move the mow/transport slide (Fig. 21) to the left to transport and to the right to mow. **The cutting units will only operate in the mow position.**

Note: Mow speed is set at the factory to 6 MPH (9.7 km/h). It can be increased or decreased by adjusting the speed stop screw (Fig. 22).

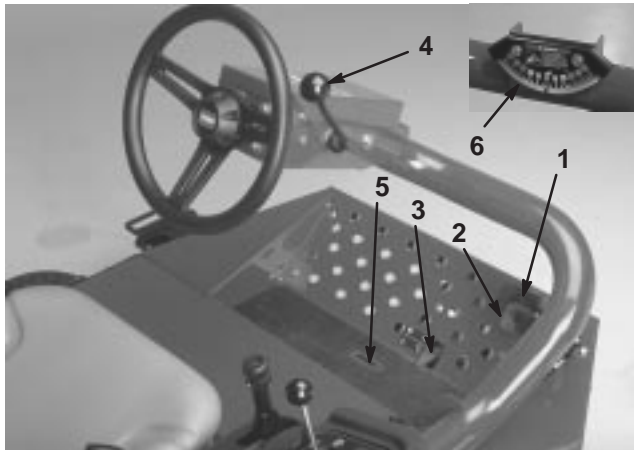

Figure 21

- | | |
|---------------------------|------------------------|
| 1. Forward traction pedal | 4. Tilt steering lever |
| 2. Reverse traction pedal | 5. Indicator slot |
| 3. Mow/transport slide | 6. Angle indicator |

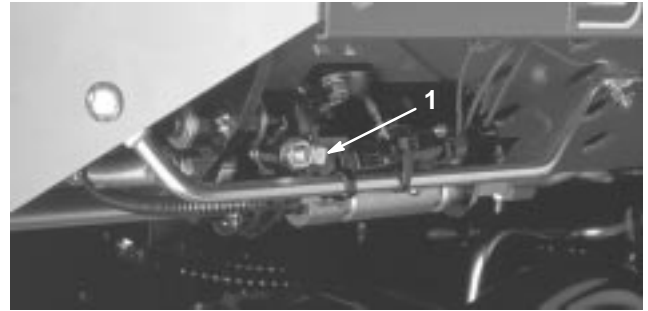

Figure 22

1. Speed stop screw

Tilt Steering Lever

Pull the tilt steering lever (Fig. 21) back to tilt the steering wheel to the desired position. Then push the lever forward to tighten.

Indicator Slot

The slot in the operator platform (Fig. 21) indicates when the cutting units are in the center position.

Angle Indicator

The angle indicator (Fig. 21) indicates the side hill angle of the machine in degrees.

Ignition Switch

The ignition switch (Fig. 23), used to start, stop and preheat the engine, has three positions: Off, On/Preheat, and Start. Rotate the key to the On/Preheat position until the glow plug indicator light goes out (approximately 7 seconds); then rotate the key to the Start position to engage the starter motor. Release the key when the engine starts. The key will move automatically to the On/Run position. To shut the engine off, rotate the key to the Off position. Remove the key from the switch to prevent accidental starting.

Throttle

Moving the throttle (Fig. 23) forward increases the engine speed; rearward decreases the engine speed.

Cutting Unit Drive Switch

The cutting unit drive switch (Fig. 23) has two positions: Engage and Disengage. The rocker switch operates a solenoid valve on the valve bank to drive the cutting units.

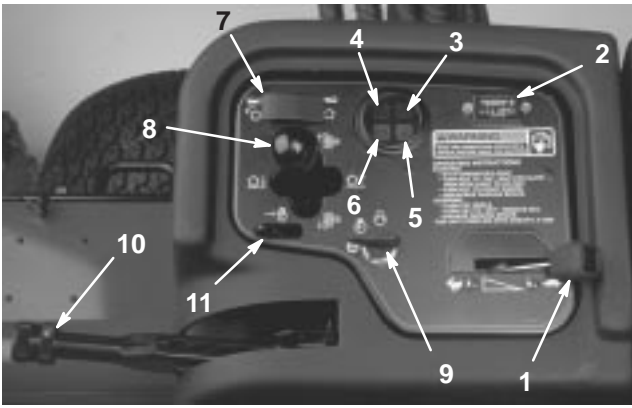

Figure 23

- | | |
|------------------------------|------------------------------|
| 1. Throttle | 7. Cutting unit drive switch |
| 2. Hour meter | 8. Cutting unit shift lever |
| 3. Temperature light | 9. Ignition switch |
| 4. Oil pressure light | 10. Parking brake |
| 5. Glow plug indicator light | 11. Lift lever lock |
| 6. Alternator light | |

Hour Meter

The hour meter (Fig. 23) indicates the total hours of machine operation. The hour meter starts to function whenever the key switch is On.

Cutting Unit Shift Lever

To lower the cutting units to the ground, move the cutting unit shift lever (Fig. 23) forward. The cutting units will not drop unless the engine is running and will not operate in the raised position. To raise the cutting units, pull the shift lever rearward to the Raise position.

Move the lever to the right or left to move the cutting units in the same direction. This should only be done when the cutting units are raised or if they are on the ground and the machine is moving.

Note: The lever does not have to be held in the forward position while the cutting units are lowered.

!
Danger
!

Shifting the cutting units downhill decreases machine stability. This could cause a rollover, which may result in personal injury or death.

Shift the cutting units uphill while on a side hill.

Engine Coolant Temperature Warning Light

The temperature warning light (Fig. 23) glows if the engine coolant temperature is high. If the traction unit is not stopped and the coolant temperature rises another 10°F, the engine will kill.

Oil Pressure Warning Light

The oil pressure warning light (Fig. 23) glows if the engine oil pressure drops below a safe level.

Alternator Light

The alternator light (Fig. 23) should be off when the engine is running. If it is on, the charging system should be checked and repaired as necessary.

Glow Plug Indicator

The glow plug indicator light (Fig. 23) will glow when the glow plugs are operating.

Parking Brake

Whenever the engine is shut off, the parking brake (Fig. 23) must be engaged to prevent accidental movement of the machine. To engage the parking brake, pull up on the lever. The engine will stop if the traction pedal is depressed with the parking brake engaged.

Lift Lever Lock

Move the lift lever lock (Fig. 23) rearward to prevent the cutting units from dropping.

Fuel Gauge

The fuel gauge (Fig. 24) registers the amount of fuel in the tank.

Seat Adjustments

Fore and Aft Adjustment (Fig. 24)—Move the lever on the side of the seat outward, slide the seat to the desired position, and release the lever to lock the seat into position.

Deluxe Seat Adjustments

Weight Adjustment—Push the lever up or down to adjust to the operator's weight: lever up—light operator, lever in middle position—medium weight operator, or lever down—heavy operator.

Inclining Backrest—Turn the handle to adjust the angle of the backrest.



Figure 24

1. Fore and aft lever
2. Fuel gauge

Starting and Stopping the Engine

Important The fuel system may have to be bled if any of the following situations have occurred:

- Initial start up of a new engine
- The engine has ceased running due to lack of fuel.
- Maintenance has been performed upon the fuel system components; i.e. filter replaced, etc.

Refer to Bleeding the Fuel System, page 21.

1. Be sure that the parking brake is set and the deck drive switch is in the Disengage position.
2. Remove your foot from the traction pedal and make sure that the pedal is in the neutral position.
3. Move the throttle lever to the 1/2 throttle position.
4. Insert the key into the switch and rotate it to the On/Preheat position until the glow plug indicator light goes out (approximately 7 seconds); then rotate the key to the Start position to engage the starter motor. Release the key when the engine starts. The key will move automatically to the On/Run position.

Important To prevent overheating of the starter motor, do not engage the starter longer than 15 seconds. After 10 seconds of continuous cranking, wait 60 seconds before engaging the starter motor again.

5. When the engine is started for the first time, or after an overhaul of the engine, operate the machine in forward and reverse for one to two minutes. Also operate the lift lever and deck drive switch to be sure of proper operation of all parts.

Turn the steering wheel to the left and right to check steering response; then shut the engine off and check for oil leaks, loose parts, and any other noticeable malfunctions.



Caution



Shut the engine off and wait for all moving parts to stop before checking for oil leaks, loose parts, and other malfunctions.

6. To stop the engine, move the throttle control to the Idle position, move the deck drive switch to Disengage, and rotate the starter key to Off. Remove the key from the switch to prevent accidental starting.

Bleeding the Fuel System

1. Park the machine on a level surface. Make sure that the fuel tank is at least half full.
2. Unlatch and raise the hood.



Danger



Under certain conditions, diesel fuel and fuel vapors are highly flammable and explosive. A fire or explosion from fuel can burn you and others and can cause property damage.

- Use a funnel and fill the fuel tank outdoors, in an open area, when the engine is off and is cold. Wipe up any fuel that spills.
- Do not fill the fuel tank completely full. Add fuel to the fuel tank until the level is 1/4 to 1/2 in. (6 to 13 mm) below the bottom of the filler neck. This empty space in the tank allows the fuel to expand.
- Never smoke when handling fuel, and stay away from an open flame or where fuel fumes may be ignited by a spark.
- Store fuel in a clean, safety-approved container and keep the cap in place.

3. Open the air bleed screw on the fuel injection pump (Fig. 25).

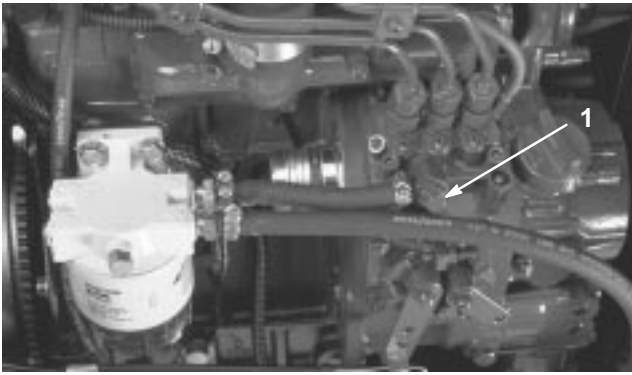

Figure 25

1. Fuel injection pump bleed screw

4. Turn the key in the ignition switch to the On position. The electric fuel pump will begin operation, thereby forcing air out around the air bleed screw. Leave the key in the On position until a solid stream of fuel flows out around the screw. Tighten the screw and turn the key to Off.

Note: Normally the engine should start after the above bleeding procedures are followed. However, if the engine does not start, air may be trapped between the injection pump and injectors; refer to Bleeding Air from the Injectors, page 33.

Checking the Interlock System



Caution



If safety interlock switches are disconnected or damaged the machine could operate unexpectedly causing personal injury.

- Do not tamper with the interlock switches.
- Check the operation of the interlock switches daily and replace any damaged switches before operating the machine.
- Replace switches every two years regardless of whether they are operating properly or not.

1. Make sure that all bystanders are away from the area of operation. Keep hands and feet away from the cutting units.
2. While sitting on the seat, the engine must not start with either the deck switch engaged or the traction pedal engaged. Correct the problem if it is not operating properly.
3. While sitting on the seat, put the traction pedal in neutral, the parking brake off, and the deck switch in the Off position. The engine should start. Rise from the

seat and slowly depress the traction pedal, the engine should stop in one to three seconds. Correct problem if it is not operating properly.

Note: The machine is equipped with an interlock switch on the parking brake. The engine will stop if the traction pedal is depressed with the parking brake engaged.

Towing the Traction Unit

In case of an emergency, the machine can be towed for a short distance; however, we do not recommend this as a standard procedure.

Important Do not tow the machine faster than 2–3 MPH (3–4 km/h) because the drive system may become damaged. If the machine must be moved a considerable distance, transport it on a truck or trailer.

1. Locate the bypass valve on the pump (Fig. 26) and rotate it 90°.

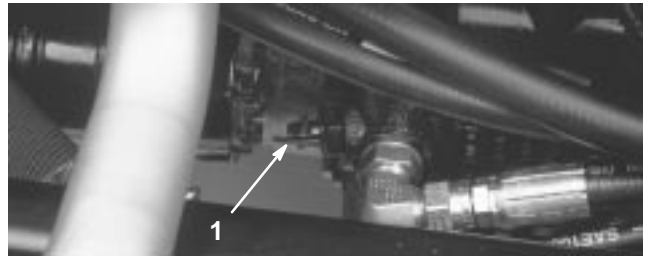



Figure 26

1. Bypass valve
2. Before starting the engine, close the bypass valve by rotating it 90° (1/4 turn). Do not start the engine when the valve is open.

Operating Characteristics

 **Danger** 

The mower has a unique traction system that will allow the machine to move forward on side hills, even if the uphill wheel should come off of the ground. If this should happen, the operator or any bystanders can be seriously injured or killed in a rollover.

The slope angle at which the machine will tip is dependent on many factors. Among these are: mowing conditions such as wet or undulating turf, speed (especially in turns), position of the cutting units (with Sidewinder), tire pressure, and operator experience.

At side hill angles of 20 degrees or less, the risk of a rollover is low. As the slope angle increases to a recommended maximum limit of 25 degrees, the risk of a rollover increases to a moderate level. *Do not exceed a 25 degree side hill slope angle because the risk of a rollover and serious injury or death is very high.*

To determine which hills or slopes may be safely operated on, a site survey of the mowing area must be done. When performing this site survey, always use common sense and take into consideration the turf condition and the rollover risk. To determine which hills or slopes may be safely operated on, use the inclinometer provided with each machine. To perform a site survey, lay a 4 ft. 2x4 (1.25 meter plank) on the slope surface and measure the angle of the slope. The 2x4 will average the slope but will not take into consideration dips or holes which can cause a sudden change in side hill angle. *The maximum side hill angle should not be greater than 25 degrees.*

Additionally, the machine is equipped with an angle indicator mounted on the steering tube. This indicates the side hill angle the machine is on and identifies the recommended maximum limit of 25 degrees.

Always wear your seat belt.

Practice operating the machine and become thoroughly familiar with it.

Start the engine and run it at half idle until it warms up. Push the throttle lever all the way forward, lift the cutting units, disengage the parking brake, press the forward traction pedal, and carefully drive to an open area.

Practice moving forward and reverse, and starting and stopping the machine. To stop, take your foot off of the traction pedal and let it return to neutral or press down on the reverse pedal to stop. Going down a hill, you may need to use the reverse pedal to stop.

When driving on slopes, drive slowly to maintain steering control and avoid turns to prevent rollovers. **In side hill situations you should shift the sidewinder cutting units to the uphill side to give you more stability. Conversely, shifting the cutting units to the down hill side will give you less stability. This should always be done before going on a side hill.**

When possible, mow up and down hills rather than across them. Have the cutting units lowered when going down a hill to maintain steering control. Do not attempt to turn on a hill.

Practice driving around obstacles with the decks up and down. Be careful when driving between narrow objects so you do not damage the machine or cutting units.

On the Sidewinder unit, get a feel for the reach of the cutting units so you do not hang them up or damage them in any way.

Do not shift the units from side to side, unless the cutting units are down and the machine is moving, or the cutting units are up in the transport position. Shifting the cutting units when they are down and the machine is not moving may cause turf damage.

Always drive slowly in rough areas.

If a person appears in or near the operating area, stop the machine, and do not start it again until the area is cleared. The machine is designed for one person. Never let anyone else ride on the machine with you. This is extremely dangerous and could result in serious injury.

Accidents can happen to anyone. The most common causes are excessive speed, sudden turns, terrain (not knowing which slopes and hills can be mowed safely), not stopping the engine before leaving the operator's seat, and drugs which impair your alertness. Cold capsules or prescription drugs may cause drowsiness, as can alcohol and other drugs. Stay alert and stay safe. Failure to do so could result in serious injury.

The Sidewinder offers up to a maximum of 13 inches (33 cm) of overhang, allowing you to trim closer to the edge of sand traps and other obstacles, while at the same time keeping the tractor tires as far away from the edge of traps or water hazards as possible.

If an obstacle is in the way, shift the cutting units to easily mow around it.

When transporting the machine from one work area to another, raise the cutting units to the fully up position, move the mow/transport slide to the left to transport, and place the throttle in the Fast position.

Mowing Techniques

To begin cutting, engage the decks, then approach the mowing area slowly. Once the front decks are over the mowing area, lower the cutting units.

To achieve the professional straight-line cut and striping that is desirable for some applications, find a tree or other object in the distance and drive straight toward it.

As soon as the front decks reach the edge of the mowing area, lift the cutting units and perform a tear drop shaped turn to quickly line you up for your next pass.

To mow around bunkers, ponds, or other contours easily, use the Sidewinder and move the control lever left or right, depending on your mowing application. The cutting units can also be shifted to vary tire tracking.

The decks tend to throw grass to the left side of the machine. If trimming around bunkers, it is best to mow in a clockwise direction to prevent throwing clippings into the bunker.

The cutting decks can be equipped with bolt-in mulching baffles. The mulching baffles perform well when turf is maintained on a regular schedule to avoid removing more than 1 inch (25 mm) of growth per cutting. When too much growth is cut with the mulching baffles installed, after-cut appearance may deteriorate and the observed power to cut the turf increases. The mulching baffles also perform well for shredding leaves in the fall of the year.

Blade Selection

Standard Angled Sail

The blade generally performs best in lower heights of cut (3/4 to 2-1/2 inch). The optional high lift parallel sail blade performs better in the higher heights of cut (2 to 4 inch).

Attributes:

- Discharge remains more even at lower heights of cut.
- Discharge has less tendency to throw left and thus a cleaner look around bunkers and fairways.
- Lower power requirement at lower heights and dense turf.

High Lift Parallel Sail

The blade generally performs better in the higher heights of cut (2 to 4 inch).

Attributes:

- More lift and higher discharge velocity.
- Sparse or limp turf is picked up significantly at higher heights of cut.
- Wet or sticky clippings are discharged more efficiently reducing congestion in deck.

- Requires more horsepower to run.
- Tends to discharge further left and can tend to windrow at lower heights of cut.



Warning



Do not use the high lift blade with the mulching baffle. The blade could break, resulting in personal injury or death.

Mow When Grass is Dry

Mow either in the late morning to avoid the dew, which causes grass clumping, or in late afternoon to avoid the damage that can be caused by direct sunlight on the sensitive, freshly mowed grass.

Select the Proper Height-of-Cut Setting to Suit Conditions

Remove approximately one inch or no more than 1/3 of the grass blade when cutting. In exceptionally lush and dense grass you may have to raise your height-of-cut setting another notch.

Always Start Mowing with Sharp Blades

A sharp blade cuts cleanly and without tearing or shredding the grass blades like a dull blade. Tearing and shredding causes the grass to turn brown at the edges which impairs growth and increases susceptibility to diseases. Make sure blade is in good condition and a full sail is present.

Check Condition of Deck

Make sure cutting chambers are in good condition. Straighten any bends in chamber components to assure correct blade tip/chamber clearance.

After Mowing

At the completion of mowing operation, thoroughly wash the machine with a garden hose without a nozzle so that excessive water pressure will not cause contamination and damage to the seals and bearings. Make sure that the radiator and oil cooler are kept free of dirt or grass clippings. After cleaning, it is recommended that the machine be inspected for possible hydraulic fluid leaks, damage or wear to the hydraulic and mechanical components, and the cutting unit blades checked for sharpness.

Important After washing the machine, move the Sidewinder mechanism from left to right several times to remove water between the bearing blocks and cross tube.

Optional Equipment Configuration					
Application		Standard Angle Sail Blade	High Lift Parallel Sail Blade DO NOT USE WITH MULCHING BAFFLE	Mulching Baffle	Roller Scraper
	Grass Cutting: .75 to 1.75 inch Height of Cut	Recommended in most applications	May work well in light or sparse turf	Has been shown to improve dispersion and after cut performance on northern grasses that are cut at least three times per week and less than 1/3 of the grass blade is removed. DO NOT USE WITH THE HIGH LIFT PARALLEL SAIL BLADE	Can be used any time that rollers build up with grass or large flat grass clumps of grass are seen. The scrapers may actually increase clumping in certain applications.
	Grass Cutting: 2.00 to 2.50 inch Height of Cut	Recommended for thick or lush turf	Recommended for light or sparse turf		
	Grass Cutting: 2.75 to 4.00 inch Height of Cut	May work well in lush turf	Recommended in most applications		
	Leaf Mulching	Recommended for use with the mulching baffle	NOT ALLOWED	Use with standard angle sail blade only	
Pros	Even discharge at lower height of cut Cleaner look around bunkers and fairways Lower power requirements	More lift and higher discharge velocity Sparse or limp turf is picked up at high height of cut Wet or sticky clippings are discharged efficiently	May improve dispersion and appearance in certain grass cutting applications Very good for leaf mulching	Reduces roller buildup in certain applications	
Cons	Does not lift the grass well in high height of cut applications Wet or sticky grass has a tendency to build up in the chamber, leading to poor quality of cut and higher power requirement	Requires more power to run in some applications Tends to windrow at lower height of cut in lush grass DO NOT USE WITH MULCHING BAFFLE	Grass will build up in the chamber if attempting to remove too much grass with baffle in place		



Maintenance

Note: Determine the left and right sides of the machine from the normal operating position.

Recommended Maintenance Schedule

Maintenance Service Interval	Maintenance Procedure
After first 10 hours	<ul style="list-style-type: none"> • Check the fan and alternator belt tension. • Replace the hydraulic filter. • Torque the wheel lug nuts.
After first 50 hours	<ul style="list-style-type: none"> • Change the engine oil and filter. • Check the engine RPM (at idle and full throttle).
Every 50 hours	<ul style="list-style-type: none"> • Inspect the air filter, dust cup, and burp valve. • Lubricate all grease fittings. • Change the engine oil. • check the battery cable connections. • Check the fan and alternator belt tension. • Check the battery fluid level.
Every 100 hours	<ul style="list-style-type: none"> • Change the engine oil filter. • Inspect the traction belt.
Every 200 hours	<ul style="list-style-type: none"> • Replace the air filter. • Replace the hydraulic filter. • Torque the wheel lug nuts.
Every 400 hours	<ul style="list-style-type: none"> • Replace the hydraulic fluid. • Replace the fuel/water separator filter. • Replace the fuel prefilter. • Inspect the traction cable movement. • Check the engine RPM (at idle and full throttle).
Every 800 hours or annually, whichever occurs first	<ul style="list-style-type: none"> • Adjust the valves. • Inspect, disassemble and install new seals in cutting unit roller assemblies.
Every 1000 hours or 2 years, whichever occurs first	<ul style="list-style-type: none"> • Replace all moving hoses. • Replace the safety switches. • Flush the cooling system and replace the fluid. • Drain and flush the fuel tank. • Drain and flush the hydraulic tank.

Important Refer to your engine operator’s manual and cutting unit operator’s manual for additional maintenance procedures.

 Caution 
<p>If you leave the key in the ignition switch, someone could accidentally start the engine and seriously injure you or other bystanders.</p> <p>Remove the key from the ignition before you do any maintenance.</p>

Daily Maintenance Checklist

Duplicate this page for routine use.

Maintenance Check Item	For the week of:						
	Mon.	Tues.	Wed.	Thurs.	Fri.	Sat.	Sun.
Check the safety interlock operation.							
Check brake operation.							
Check the engine oil level.							
Check the cooling system fluid level.							
Drain the water/fuel separator.							
Check the air filter, dust cup, and burp valve.							
Check the radiator and screen for debris.							
Check for unusual engine noises. ¹							
Check for unusual operating noises.							
Check the hydraulic system oil level.							
Check the hydraulic hoses for damage.							
Check for fluid leaks.							
Check the fuel level.							
Check the tire pressure.							
Check instrument operation.							
Check the height-of-cut adjustment.							
Lubricate all grease fittings. ²							
Touch up damaged paint.							

¹Check the glow plug and injector nozzles if starting is hard, there is excess smoke, or rough running is noted.

²Immediately **after every** washing, regardless of the interval listed

Notation for Areas of Concern

Inspection performed by:		
Item	Date	Information
1		
2		
3		
4		
5		
6		
7		
8		
9		
10		

Greasing the Bearings and Bushings

The traction unit has grease fittings that must be lubricated regularly with No. 2 General Purpose Lithium Base Grease. If the machine is operated under normal conditions, lubricate the bearings and bushings after every 50 hours of operation. The bearings and bushings must be lubricated daily when operating conditions are extremely dusty and dirty. Dusty and dirty operating conditions could cause dirt to get into the bearings and bushings, resulting in accelerated wear. Lubricate bearings and bushings immediately **after every** washing, regardless of the interval listed.

The traction unit bearings and bushings that must be lubricated are: rear cutting unit pivot (Fig. 27), front cutting unit pivot (Fig. 28), SideWinder cylinder ends (2) (Model No. 03201 only) (Fig. 29), steering pivot (Fig. 30), rear lift arm pivot and lift cylinder (2) (Fig. 31), left front lift arm pivot and lift cylinder (2) (Fig. 32), right front lift arm pivot and lift cylinder (2) (Fig. 33), neutral adjust mechanism (Fig. 34), mow/transport slide (Fig. 35), belt tension pivot (Fig. 36), and steering cylinder (Fig. 37).

Note: If desired, an additional grease fitting may be installed in the other end of the steering cylinder. Remove the tire, install the fitting, grease the fitting, remove the fitting, and install the plug (Fig. 38).

Important Do not lubricate the Sidewinder cross tube. The bearing blocks are self-lubricated.

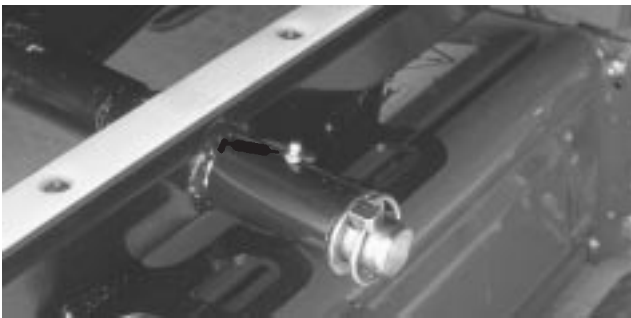

Figure 27



Figure 28

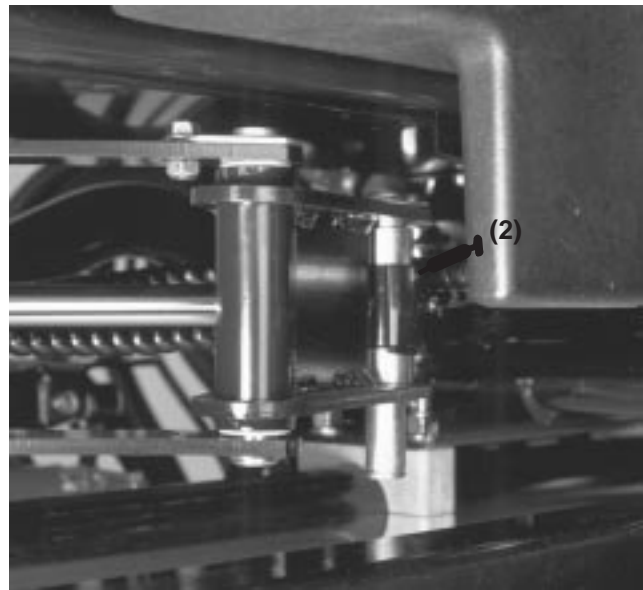

Figure 29

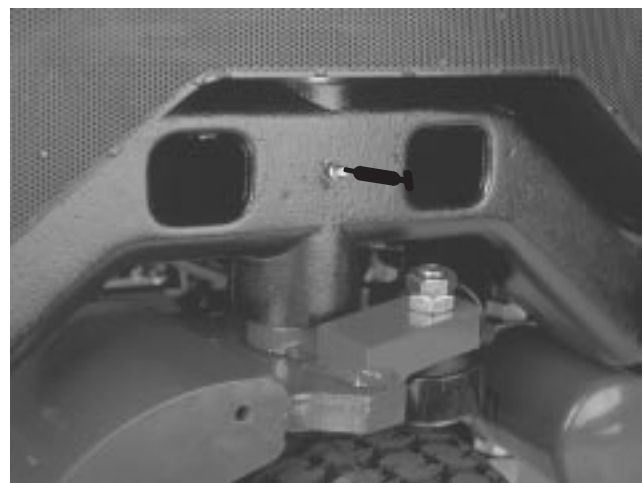

Figure 30

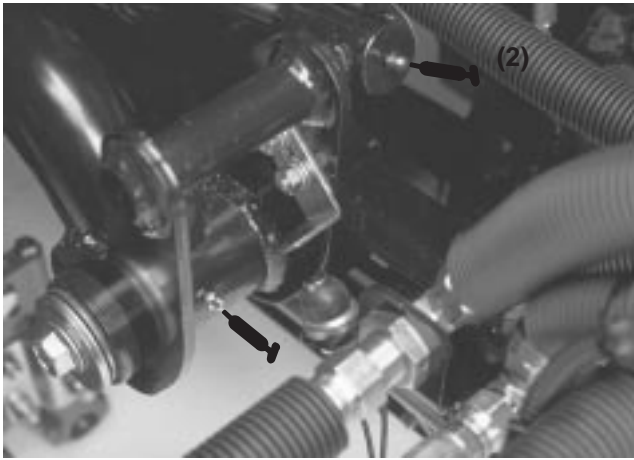

Figure 31

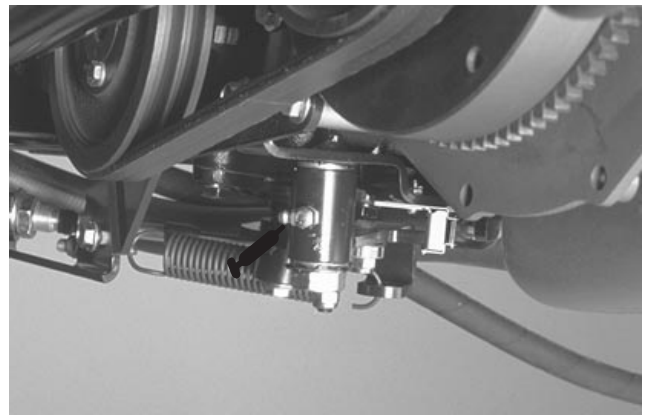

Figure 34

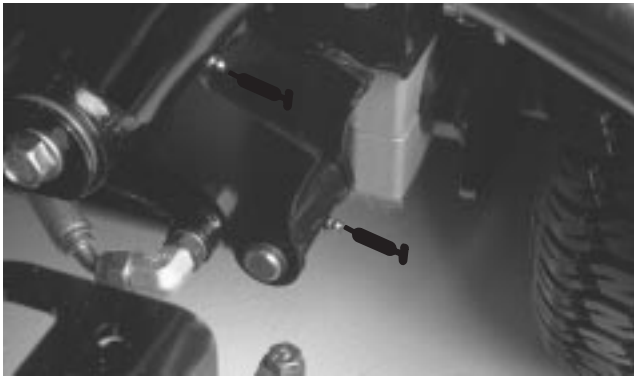

Figure 32

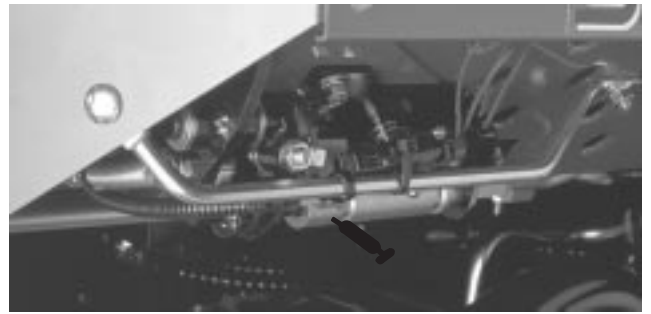

Figure 35

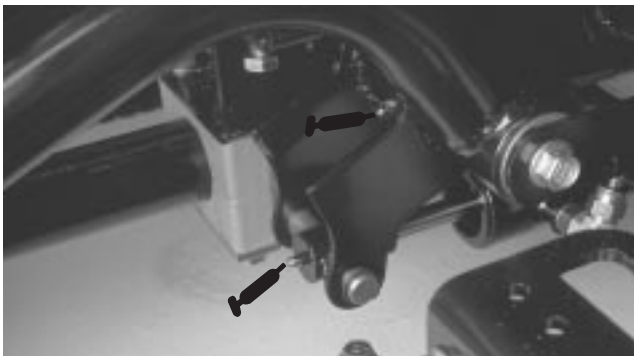

Figure 33

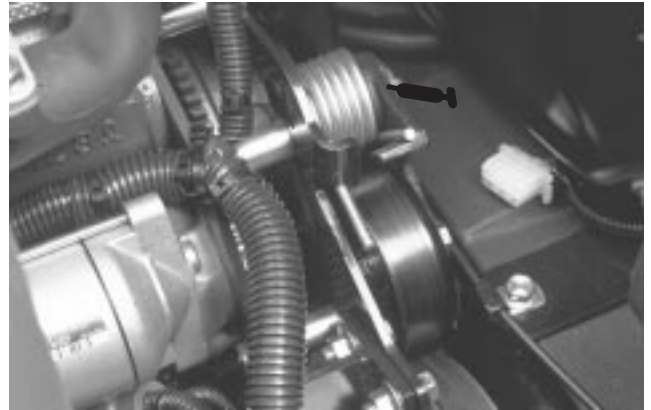

Figure 36



Figure 37



Figure 38
See note

Removing the Hood

The hood may be easily removed to ease maintenance procedures in the engine area of the machine.

1. Unlatch and raise the hood.
2. Remove the cotter pin securing the hood pivot to the mounting brackets (Fig. 39).



Figure 39

1. Cotter pin

3. Slide the hood to the right side, lift the other side, and pull it out of the brackets.
4. Reverse the procedure to install the hood.

Servicing the Air Cleaner

Check air cleaner body for damage which could possibly cause an air leak. Replace a damaged air cleaner body.

Service the air cleaner filter every 200 hours (more frequently in extreme dusty or dirty conditions).

Be sure that cover is sealing around the air cleaner body.

1. Release the latches securing the air cleaner cover to the air cleaner body (Fig. 40). Separate the cover from the body. Clean the inside of the air cleaner cover.

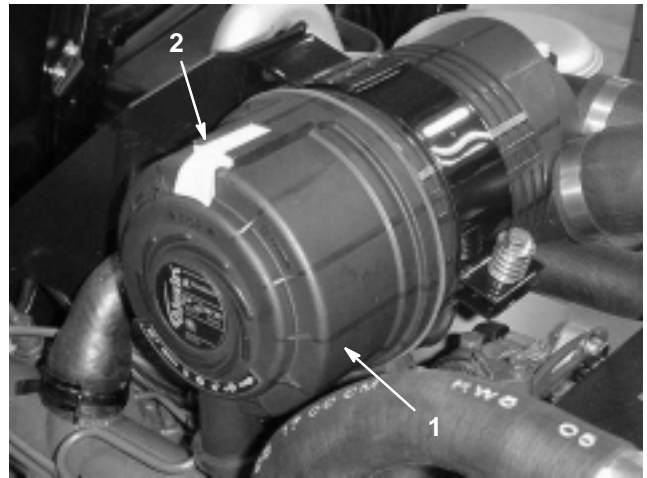

Figure 40

1. Air cleaner dust cup
 2. Air cleaner latch
2. Gently slide the filter out of the air cleaner body to reduce the amount of dust dislodged. Avoid knocking the filter against the air cleaner body.
 3. Inspect the filter (Fig. 41) and discard it if it is damaged. Do not wash or reuse a damaged filter.

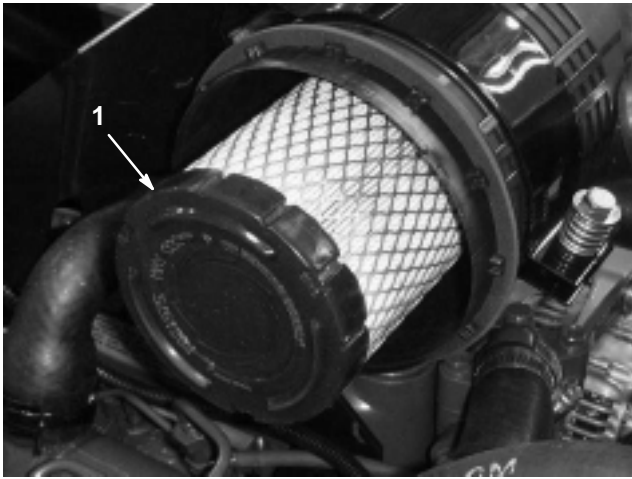

Figure 41

1. Filter element

4. Washing Method

- A. Prepare a solution of filter cleaner and water and soak the filter element for about 15 minutes; refer to the directions on the filter cleaner carton for complete information.
- B. After soaking the filter for 15 minutes, rinse it with clear water. The maximum water pressure must not exceed 40 psi (276 kPa) to prevent damage to the filter element. Rinse the filter from the clean side to the dirty side.
- C. Dry the filter element using warm, flowing air (160°F [71°C] maximum), or allow the element to air-dry. Do not use a light bulb to dry the filter element because damage could result.

5. Compressed Air Method

- A. Blow compressed air from the inside to the outside of a dry filter element. To prevent damage to the element, do not exceed 100 psi (689 kPa).
 - B. Keep the air hose nozzle at least 2 in. (5 cm) from the filter and move the nozzle up and down while rotating the filter element. Inspect the filter for holes and tears by looking through it toward a bright light.
6. Inspect the new filter for shipping damage. Check the sealing end of the filter. Do not install a damaged filter.
 7. Insert the new filter properly into the air cleaner body. Make sure that the filter is sealed properly by applying pressure to the outer rim of the filter when installing it. Do not press on the flexible center of the filter.
 8. Install the cover and secure the latches. Make sure that the cover is positioned with the TOP side up.

Servicing the Engine Oil and Filter

Change the oil and filter initially after the first 50 hours of operation; thereafter change the oil every 50 hours and the filter every 100 hours.

1. Remove either drain plug (Fig. 42) and let oil flow into a drain pan. When the oil stops flowing, install the drain plug.

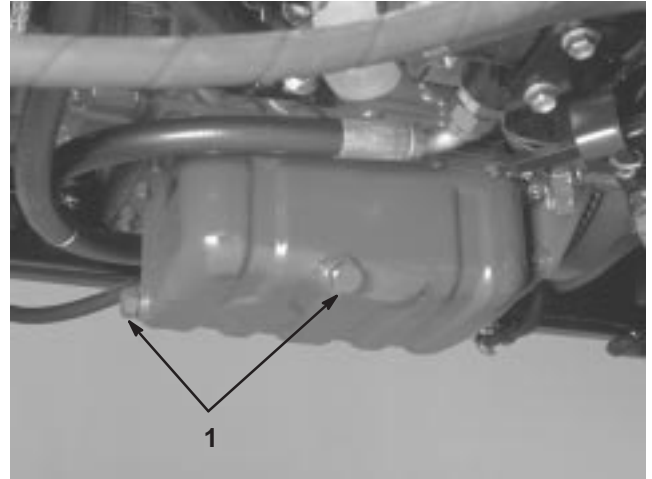

Figure 42

1. Engine oil drain plug

2. Remove the oil filter (Fig. 43). Apply a light coat of clean oil to the new filter seal before screwing it on. **Do not overtighten.**

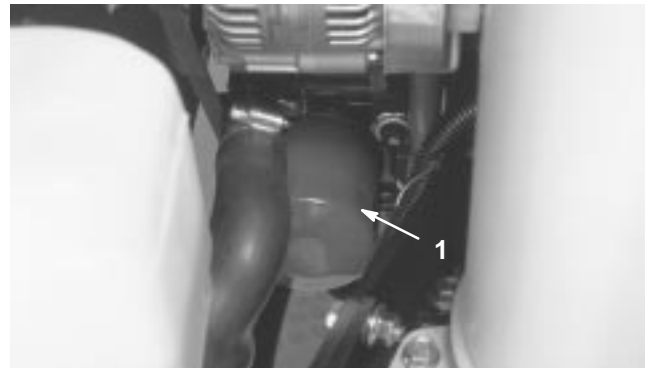

Figure 43

1. Engine oil filter

3. Add oil to the crankcase; refer to Checking the Crankcase Oil, page 16.

Servicing the Fuel System

Fuel Tank

Drain and clean the fuel tank every 2 years. Also, drain and clean the tank if the fuel system becomes contaminated or if the machine will be stored for an extended period of time. Use clean fuel to flush out the tank.

Fuel Lines and Connections

Check the fuel lines and connections every 400 hours or yearly, whichever comes first. Inspect them for deterioration, damage, or loose connections.

Water Separator

Drain water or other contaminants from the water separator (Fig. 44) daily.

1. Place a clean container under the fuel filter.
2. Loosen the drain plug on the bottom of the filter canister (Fig. 44). Tighten the plug after draining.

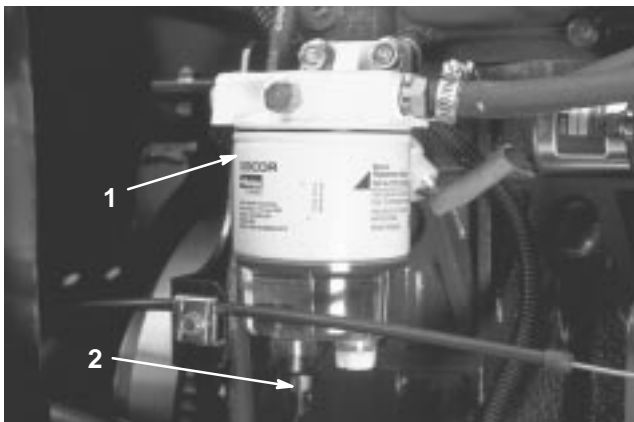

Figure 44

1. Water separator
2. Drain plug

Replace the filter canister after every 400 hours of operation.

1. Clean the area where the filter canister mounts.
2. Remove the filter canister and clean the mounting surface.
3. Lubricate the gasket on the filter canister with clean oil.
4. Install the filter canister by hand until the gasket contacts the mounting surface; then rotate an additional 1/2 turn.

Replacing the Fuel Prefilter

Replace the fuel prefilter, located on the inside of the frame rail below the water separator, after every 400 operating hours or yearly, whichever occurs first.

1. Remove the screw securing the filter to the frame rail.
2. Clamp both fuel lines that connect to the fuel filter so that fuel cannot drain when the lines are removed.
3. Loosen the hose clamps at both ends of the filter (Fig. 45) and pull the fuel lines off of the filter.

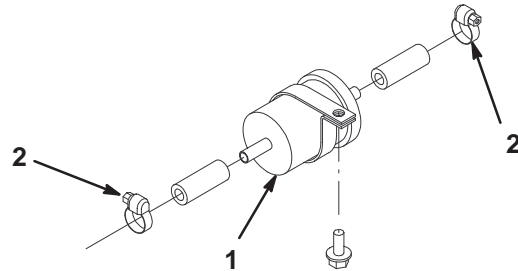

Figure 45

1. Fuel prefilter
2. Hose clamps

4. Remove the clamp from the fuel filter and slide it onto the replacement filter. Push the fuel lines onto the replacement fuel filter and secure them with the hose clamps. Be sure that the arrow on the side of the filter points toward the injection pump.
5. Secure the filter to the frame rail with the previously removed screw.



Danger



Under certain conditions, diesel fuel and fuel vapors are highly flammable and explosive. A fire or explosion from fuel can burn you and others and can cause property damage.

- Use a funnel and fill the fuel tank outdoors, in an open area, when the engine is off and is cold. Wipe up any fuel that spills.
- Do not fill the fuel tank completely full. Add fuel to the fuel tank until the level is 1/4 to 1/2 in. (6 to 13 mm) below the bottom of the filler neck. This empty space in the tank allows the fuel to expand.
- Never smoke when handling fuel, and stay away from an open flame or where fuel fumes may be ignited by a spark.
- Store fuel in a clean, safety-approved container and keep the cap in place.

Bleeding Air from the Injectors

Note: This procedure should be used only if the fuel system has been purged of air through normal priming procedures and the engine will not start; refer to Bleeding the Fuel System, page 21.

1. Loosen the pipe connection to the No. 1 nozzle and holder assembly.

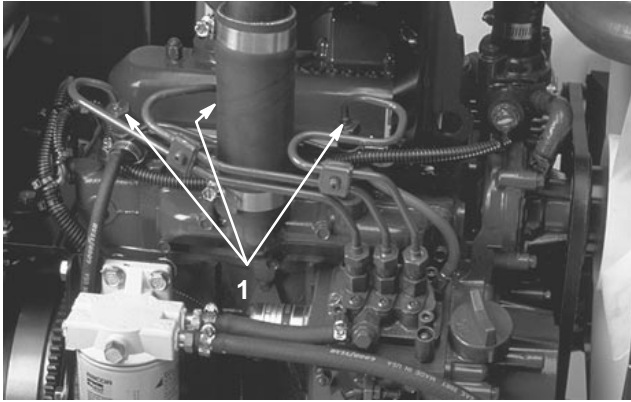

Figure 46

1. Fuel injectors
-

2. Move the throttle to the Fast position.
3. Turn the key in the key switch to the Start position and watch the fuel flow around the connector. Turn the key to the Off position when solid flow is observed.
4. Tighten the pipe connector securely.
5. Repeat the procedure on the remaining nozzles.

Cleaning the Engine Cooling System

Remove debris from the oil cooler and radiator daily. Clean them more frequently in dirty conditions.

1. Turn the engine off and raise the hood. Clean the engine area thoroughly of all debris.
2. Remove the access panel (Fig. 47).

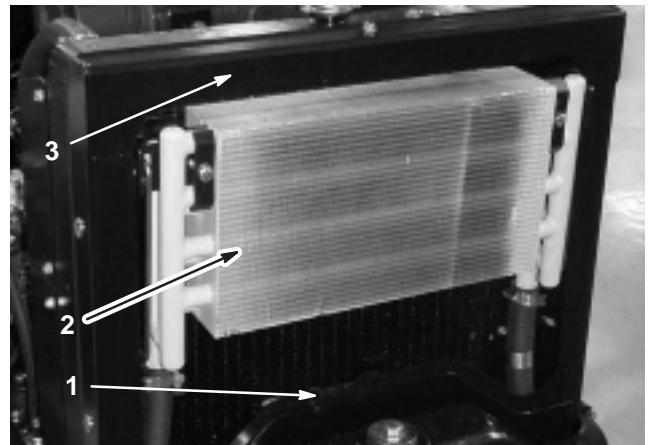

Figure 47

1. Access panel
 2. Oil cooler
 3. Radiator
-

3. Unlatch the oil cooler and pivot it rearward (Fig. 48). Clean both sides of the oil cooler and radiator area thoroughly with water or compressed air. Pivot the oil cooler back into position.

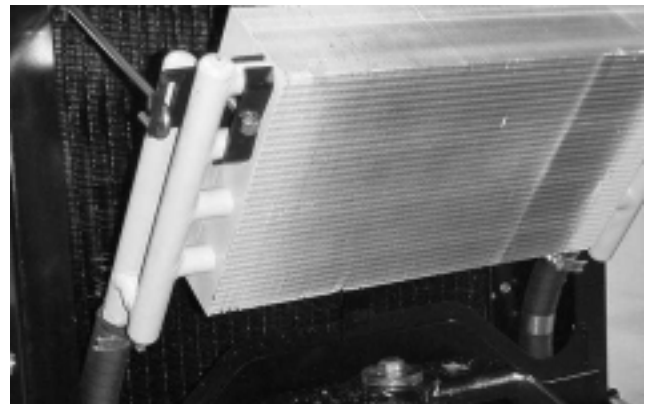

Figure 48

4. Install the access panel and close the hood.

Servicing the Engine Belts

Check condition and tension of all belts after first day of operation and every 100 operating hours thereafter.

Alternator/Fan Belt (Fig. 49)

1. Open the hood.
2. Check the tension by depressing the belt midway between the alternator and crankshaft pulleys with 22 lb. (30 N·m) of force. The belt should deflect 7/16 in. (11 mm). If the deflection is incorrect, proceed to step 3. If it is correct, continue operation.
3. Loosen the bolt securing the brace to the engine and the bolt securing the alternator to the brace.
4. Insert a pry bar between the alternator and engine and pry out on the alternator.
5. When the proper tension is achieved, tighten the alternator and brace bolts to secure the adjustment.

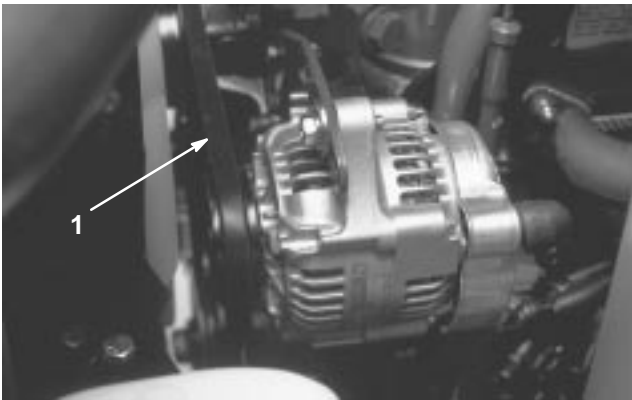

Figure 49

1. Alternator/fan belt

Replacing the Hydrostat Drive Belt

1. Insert a nut driver or small piece of tubing onto the end of the belt tensioning spring.



Warning



Use caution when de-tensioning the spring, as it is under a heavy load.

2. Push down and forward on the spring end (Fig. 50) to unhook it from the bracket and release tension on the spring.
3. Replace the belt.
4. Reverse the procedure to tension the spring.

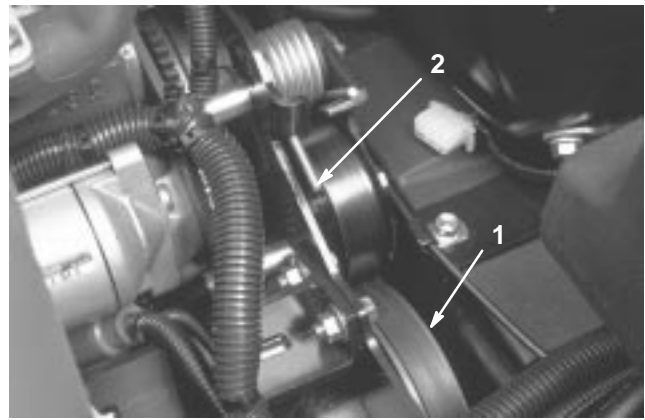

Figure 50

1. Hydrostat drive belt
2. Spring end

Adjusting the Throttle

1. Position the throttle lever rearward so it stops against the control panel slot.
2. Loosen the throttle cable connector on the injection pump lever arm (Fig. 51).

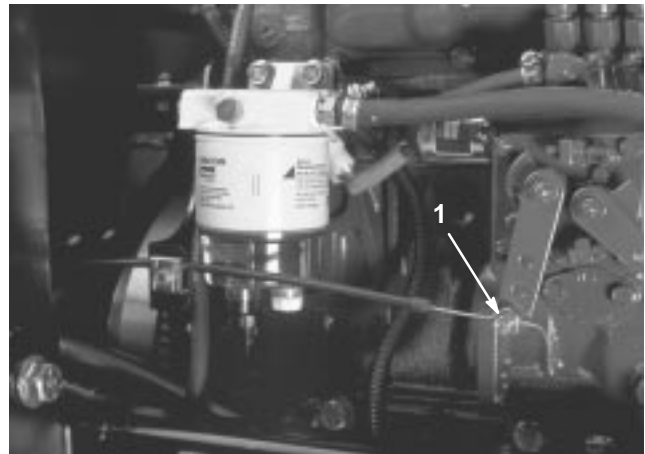

Figure 51

1. Injection pump lever arm

3. Hold the injection pump lever arm against the low idle stop and tighten the cable connector.
4. Loosen the screws securing the throttle control to the control panel.
5. Push the throttle control lever all of the way forward.
6. Slide the stop plate until it contacts the throttle lever and tighten the screws securing the throttle control to the control panel.

- If the throttle does not stay in position during operation, torque the locknut, used to set the friction device on the throttle lever, to 40–55 in.-lb. (5–6 N·m). The maximum force required to operate the throttle lever should be 20 lb. (27 N·m).

Changing the Hydraulic Fluid

Change the hydraulic fluid after every 400 operating hours, in normal conditions. If the fluid becomes contaminated, contact your local Toro distributor because the system must be flushed. Contaminated fluid looks milky or black when compared to clean oil.

- Turn the engine off and raise the hood.
- Disconnect the hydraulic line (Fig. 52) or remove the hydraulic filter (Fig. 53) and let the hydraulic fluid flow into a drain pan. Install the hydraulic line when hydraulic fluid stops draining.

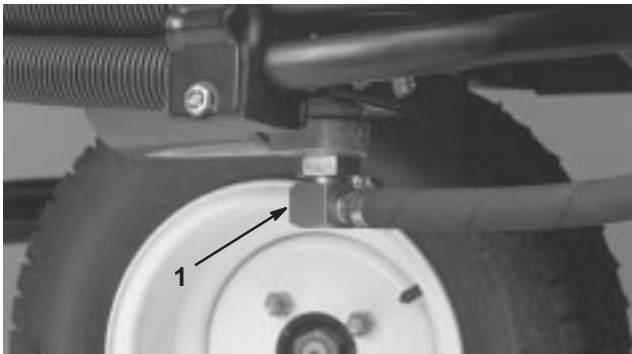

Figure 52

- Hydraulic line



Figure 53

- Hydraulic filter

- Fill the reservoir (Fig. 54) with approximately 3.5 U.S. gallons (13.2 l) of hydraulic fluid; refer to Checking the Hydraulic System, page 17.

Important Use only the hydraulic fluids specified. Other fluids could cause system damage.

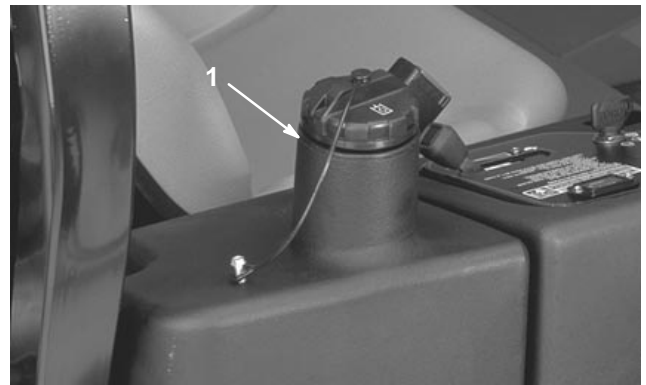

Figure 54

- Hydraulic reservoir

- Install the reservoir cap. Start the engine and use all of the hydraulic controls to distribute the hydraulic fluid throughout the system. Also check for leaks; then stop the engine.
- Check the fluid level and add enough to raise the level to FULL mark on the dipstick. **Do not overfill.**

Replacing the Hydraulic Filter

The hydraulic system filter must be changed initially, after the first 10 hours of operation, and thereafter every 200 hours of operation or yearly, whichever comes first. Use a genuine Toro oil filter for replacement. The hydraulic oil must be changed every 400 hours of operation or yearly, whichever comes first.

Use Toro replacement filter Part No. 86-3010.

Important Use of any other filter may void the warranty on some components.

- Position the machine on a level surface, lower the cutting units, stop the engine, engage the parking brake, and remove the key from the ignition switch.
- Pinch off the hose to the filter mounting plate.
- Clean around the filter mounting area. Place a drain pan under the filter (Fig. 53) and remove the filter.
- Lubricate the new filter gasket and fill the filter with hydraulic fluid.
- Ensure that the filter mounting area is clean. Screw the filter on until the gasket contacts the mounting plate; then tighten the filter 1/2 turn.
- Start the engine and let it run for about two minutes to purge air from the system. Stop the engine and check for leaks.

Checking the Hydraulic Lines and Hoses

Daily, check hydraulic lines and hoses for leaks, kinked lines, loose mounting supports, wear, loose fittings, weather deterioration, and chemical deterioration. Make all necessary repairs before operating.



Warning



Hydraulic fluid escaping under pressure can penetrate skin and cause injury.

- Make sure all hydraulic fluid hoses and lines are in good condition and all hydraulic connections and fittings are tight before applying pressure to the hydraulic system.
- Keep your body and hands away from pin hole leaks or nozzles that eject high pressure hydraulic fluid.
- Use cardboard or paper to find hydraulic leaks.
- Safely relieve all pressure in the hydraulic system before performing any work on the hydraulic system.
- Seek immediate medical attention if fluid is injected into skin.

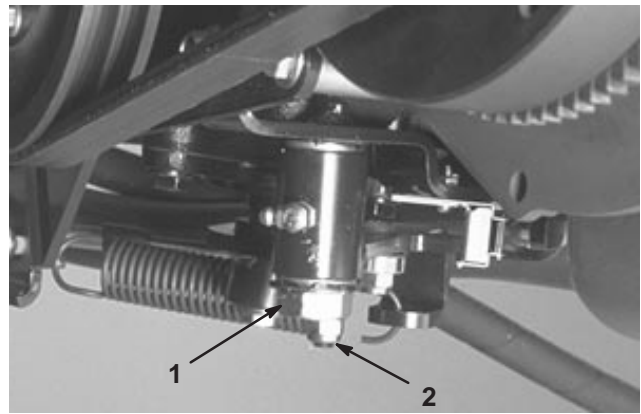

Figure 55

1. Traction adjustment cam 2. Locknut

Adjusting the Traction Drive for Neutral

If the machine moves when the traction pedal is in the neutral position, the traction cam must be adjusted.

1. Park the machine on a level surface and turn the engine off.
2. Raise one front wheel and one rear wheel off of the floor and place support blocks under the frame.



Warning



If the machine is not supported adequately, it may accidentally fall, injuring anyone under the machine.

One front wheel *and* one rear wheel must be raised off of the ground or the machine will move during adjustment.

3. Loosen the locknut on the traction adjustment cam (Fig. 55).



Warning



The engine must be running so a final adjustment of the traction adjustment cam can be performed. Contact with hot or moving parts can result in personal injury.

Keep hands, feet, face, and other body parts away from the muffler, other hot parts of the engine, and other rotating parts.

4. Start the engine and rotate the cam hex in both directions to determine the mid position of the neutral span.
5. Tighten the locknut securing the adjustment.
6. Stop the engine.
7. Remove the support blocks and lower the machine to the shop floor. Test drive the machine to make sure it does not move when the traction pedal is in neutral.

Adjusting the Parking Brake

Check the adjustment of the parking brake every 200 hours.

1. Loosen the set screw securing the knob to the parking brake lever (Fig. 56).
2. Rotate the knob until a force of 30–40 lb. (41–68 N·m) is required to actuate the lever.
3. Tighten the set screw after the adjustment has been attained.

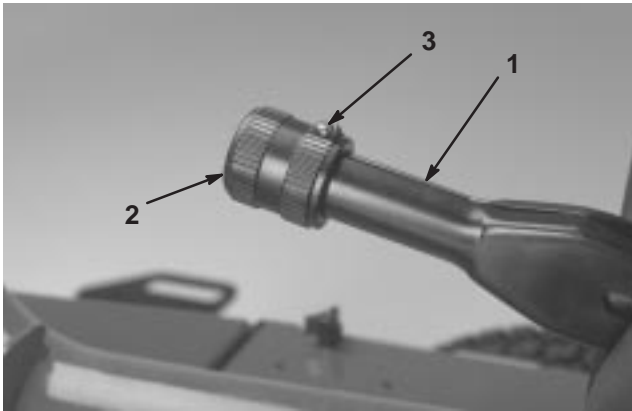

Figure 56

1. Parking brake lever
2. Knob
3. Set screw

Caring for the Battery

The battery electrolyte level must be properly maintained and the top of the battery kept clean. If the machine is stored in a location where temperatures are extremely high, the battery will run down more rapidly than if the machine is stored in a location where temperatures are cool.

Check the electrolyte level every 25 operating hours or, if machine is in storage, every 30 days.

Maintain the cell level with distilled or demineralized water. Do not fill the cells above the bottom of the split ring inside each cell. Install the filler caps with the vents pointing to the rear (toward the fuel tank).

Danger

Battery electrolyte contains sulfuric acid which is a deadly poison and causes severe burns.

- Do not drink electrolyte and avoid contact with skin, eyes or clothing. Wear safety glasses to shield your eyes and rubber gloves to protect your hands.
- Fill the battery where clean water is always available for flushing the skin.

Keep the top of the battery clean by washing it periodically with a brush dipped in ammonia or bicarbonate of soda solution. Flush the top surface with water after cleaning. Do not remove the filler caps while cleaning.

The battery cables must be tight on the terminals to provide good electrical contact.

Warning

Incorrect battery cable routing could damage the tractor and cables causing sparks. Sparks can cause the battery gasses to explode, resulting in personal injury.

- Always *disconnect* the negative (black) battery cable before disconnecting the positive (red) cable.
- Always *connect* the positive (red) battery cable before connecting the negative (black) cable.

If corrosion occurs at the terminals, disconnect the cables, negative (–) cable first, and scrape the clamps and terminals separately. Reconnect the cables, positive (+) cable first, and coat the terminals with petroleum jelly.

Always disconnect the battery cables, ground cable (–) first, to prevent possible wiring damage from shorts whenever working with the electrical system.

Warning

CALIFORNIA

Proposition 65 Warning

Battery posts, terminals, and related accessories contain lead and lead compounds, chemicals known to the State of California to cause cancer and reproductive harm. Wash hands after handling.

Storing the Battery

If the machine will be stored more than 30 days, remove the battery and charge it fully. Either store it on the shelf or on the machine. Leave the cables disconnected if it is stored on the machine. Store the battery in a cool atmosphere to avoid quick deterioration of the charge in the battery. To prevent the battery from freezing, make sure it is fully charged. The specific gravity of a fully charged battery is 1.265–1.299.

Fuses

The fuses in machines electrical system are located under console cover.

Electrical Schematic

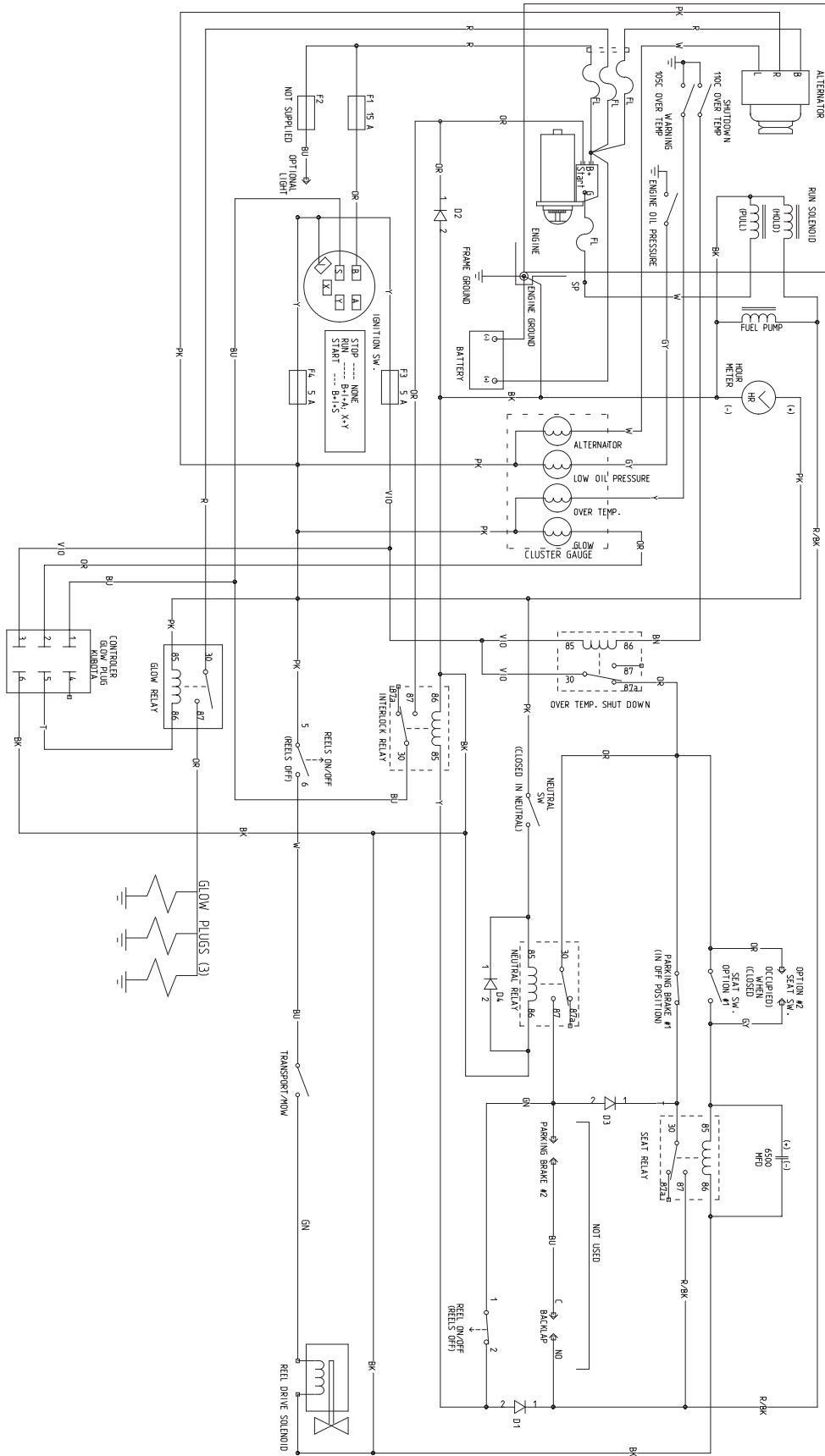

Hydraulic Schematic

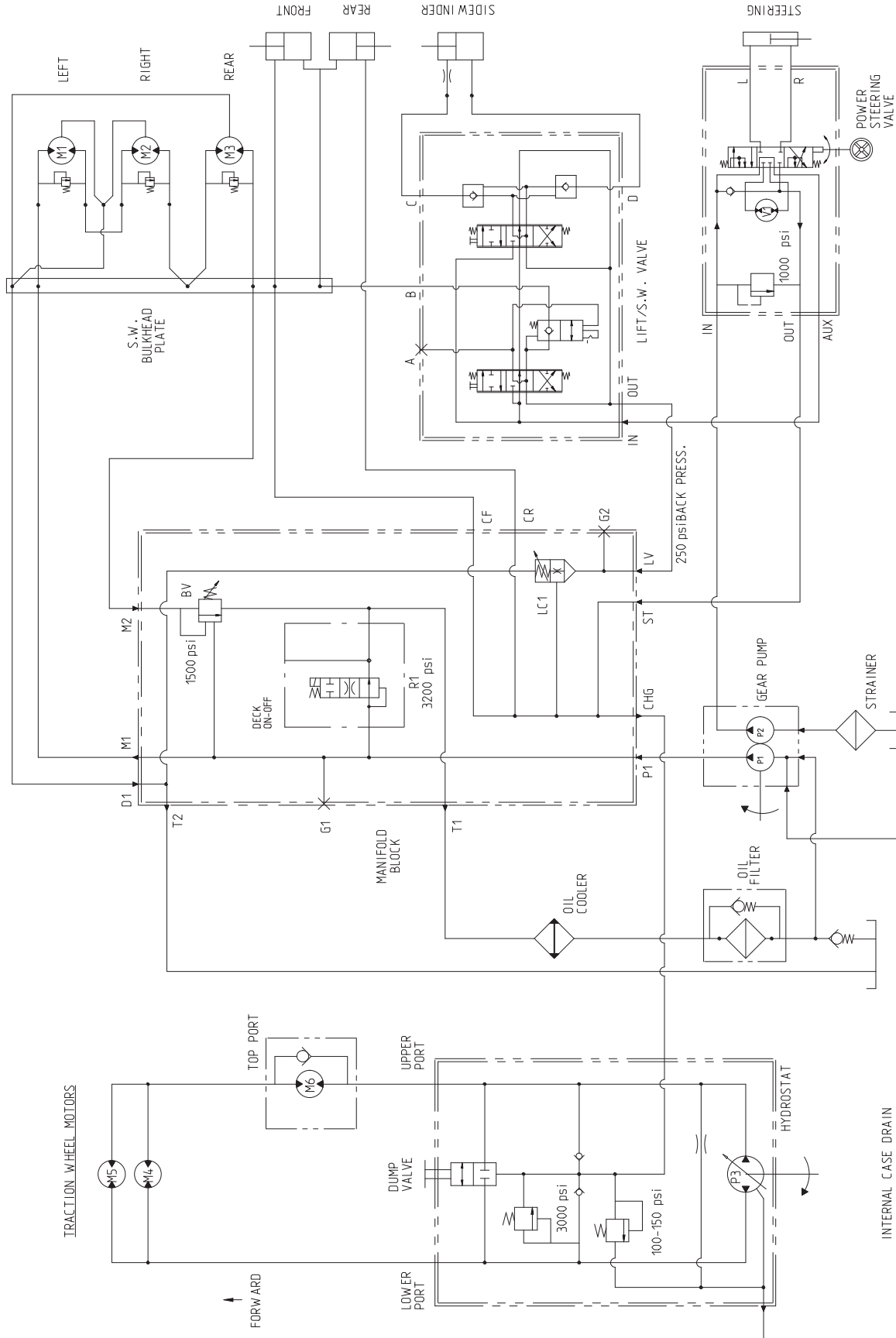

Preparation for Seasonal Storage

Traction Unit

1. Thoroughly clean the traction unit, cutting units, and engine.
2. Check the tire pressure. Inflate all tires to 14–18 psi (97–110 kPa).
3. Check all fasteners for looseness; tighten as necessary.
4. Grease or oil all grease fittings and pivot points. Wipe up any excess lubricant.
5. Cover the entire length of the Sidewinder cross tube with a light oil to prevent rust. After storage, wipe off all of the oil.
6. Lightly sand and use touch-up paint on painted areas that are scratched, chipped, or rusted. Repair any dents in the metal body.
7. Service the battery and cables as follows:
 - A. Remove the battery terminals from the battery posts.
 - B. Clean the battery, terminals, and posts with a wire brush and baking soda solution.
 - C. Coat the cable terminals and battery posts with Grafo 112X skin-over grease (Toro Part No. 505-47) or petroleum jelly to prevent corrosion.
 - D. Slowly recharge the battery every 60 days for 24 hours to prevent lead sulfation of the battery.

Engine

1. Drain the engine oil from the oil pan and replace the drain plug.
2. Remove and discard the oil filter. Install a new oil filter.
3. Refill the oil pan with approximately 4 U.S. quarts (3.8 l) of SAE10W-30 motor oil.
4. Start the engine and run it at idle speed for approximately two minutes.
5. Stop the engine.
6. Thoroughly drain all fuel from the fuel tank, fuel lines, fuel filter, and water separator assembly.
7. Flush the fuel tank with fresh, clean diesel fuel.
8. Secure all fuel system fittings.
9. Thoroughly clean and service the air cleaner assembly.
10. Seal the air cleaner inlet and the exhaust outlet with weatherproof tape.
11. Check anti-freeze protection and add as needed for expected minimum temperature in your area.



The Toro General Commercial Products Warranty

A Two-Year Limited Warranty

Conditions and Products Covered

The Toro Company and its affiliate, Toro Warranty Company, pursuant to an agreement between them, jointly warrant your 1996 or newer Toro Commercial Product ("Product") purchased after January 1, 1997, to be free from defects in materials or workmanship for two years or 1500 operational hours*, whichever occurs first. Where a warrantable condition exists, we will repair the Product at no cost to you including diagnosis, labor, parts, and transportation. This warranty begins on the date the Product is delivered to the original retail purchaser.

* Product equipped with hour meter

Instructions for Obtaining Warranty Service

You are responsible for notifying the Commercial Products Distributor or Authorized Commercial Products Dealer from whom you purchased the Product as soon as you believe a warrantable condition exists.

If you need help locating a Commercial Products Distributor or Authorized Dealer, or if you have questions regarding your warranty rights or responsibilities, you may contact us at:

Toro Commercial Products Service Department
Toro Warranty Company
8111 Lyndale Avenue South
Bloomington, MN 55420-1196
952-888-8801 or 800-982-2740
E-mail: commercial.service@toro.com

Owner Responsibilities

As the Product owner, you are responsible for required maintenance and adjustments stated in your operator's manual. Failure to perform required maintenance and adjustments can be grounds for disallowing a warranty claim.

Items and Conditions Not Covered

Not all product failures or malfunctions that occur during the warranty period are defects in materials or workmanship. This express warranty does not cover the following:

- Product failures which result from the use of non-Toro replacement parts, or from installation and use of add-on, modified, or unapproved accessories
- Product failures which result from failure to perform required maintenance and/or adjustments
- Product failures which result from operating the Product in an abusive, negligent or reckless manner
- Parts subject to consumption through use unless found to be defective. Examples of parts which are consumed, or used up, during normal Product operation include, but are not limited to, blades, reels, bedknives, tines, spark plugs, castor wheels, tires, filters, belts, etc.

Countries Other than the United States or Canada

Customers who have purchased Toro products exported from the United States or Canada should contact their Toro Distributor (Dealer) to obtain guarantee policies for your country, province, or state. If for any reason you are dissatisfied with your Distributor's service or have difficulty obtaining guarantee information, contact the Toro importer. If all other remedies fail, you may contact us at Toro Warranty Company.

- Failures caused by outside influence. Items considered to be outside influence include, but are not limited to, weather, storage practices, contamination, use of unapproved coolants, lubricants, additives, or chemicals, etc.
- Normal "wear and tear" items. Normal "wear and tear" includes, but is not limited to, damage to seats due to wear or abrasion, worn painted surfaces, scratched decals or windows, etc.

Parts

Parts scheduled for replacement as required maintenance are warranted for the period of time up to the scheduled replacement time for that part.

Parts replaced under this warranty become the property of Toro. Toro will make the final decision whether to repair any existing part or assembly or replace it. Toro may use factory remanufactured parts rather than new parts for some warranty repairs.

General Conditions

Repair by an Authorized Toro Distributor or Dealer is your sole remedy under this warranty.

Neither The Toro Company nor Toro Warranty Company is liable for indirect, incidental or consequential damages in connection with the use of the Toro Products covered by this warranty, including any cost or expense of providing substitute equipment or service during reasonable periods of malfunction or non-use pending completion of repairs under this warranty. Except for the Emissions warranty referenced below, if applicable, there is no other express warranty. All implied warranties of merchantability and fitness for use are limited to the duration of this express warranty.

Some states do not allow exclusions of incidental or consequential damages, or limitations on how long an implied warranty lasts, so the above exclusions and limitations may not apply to you.

This warranty gives you specific legal rights, and you may also have other rights which vary from state to state.

Note regarding engine warranty: The Emissions Control System on your Product may be covered by a separate warranty meeting requirements established by the U.S. Environmental Protection Agency (EPA) and/or the California Air Resources Board (CARB). The hour limitations set forth above do not apply to the Emissions Control System Warranty. Refer to the Engine Emission Control Warranty Statement printed in your operator's manual or contained in the engine manufacturer's documentation for details.