



Multi-Pro[®] 1250 Turf Sprayer

Model No. 41163—Serial No. 25000001 and Up

Operator's Manual



Warning



CALIFORNIA

Proposition 65 Warning

The engine exhaust from this product contains chemicals known to the State of California to cause cancer, birth defects, or other reproductive harm.

Important The engine in this product is not equipped with a spark arrester muffler. It is a violation of California Public Resource Code Section 4442 to use or operate this engine on any forest-covered, brush-covered, or grass-covered land as defined in CPRC 4126. Other states or federal areas may have similar laws.

This spark ignition system complies with Canadian ICES-002.

Ce système d'allumage par étincelle de véhicule est conforme à la norme NMB-002 du Canada.

Contents

	Page
Introduction	3
Safety	3
Safe Operating Practices	3
Chemical Safety	4
Before Operating	4
While Operating	5
Maintenance	6
Sound Pressure	7
Vibration	7
Safety and Instruction Decals	7
Specifications	11
Optional Equipment	11
Setup	12
Loose Parts	12
Installing the Anti-siphon Fill Receptacle	13
Installing the Spray Pro Monitor	13
Before Operating	14
Checking the Engine Oil	14
Checking the Tire Pressure	14
Adding Fuel	14
Checking the Air Intake Screen	15
Checking the Brake Fluid	15
Checking the Transaxle/Hydraulic Fluid	16
Filling the Fresh Water Tank	16

	Page
Operation	16
Think Safety First	16
Vehicle Controls	17
Pre-Starting Checks	18
Starting the Engine	19
Driving the Sprayer	19
Stopping the Engine	19
New Sprayer Break-In	19
Transporting the Sprayer	19
Towing the Sprayer	20
Sprayer Controls and Components	20
Spray Pro™ Monitor	23
Calibrating the Spray Pro Monitor	24
Adjusting the Boom Bypass Valves	25
Operating the Sprayer	26
Maintenance	28
Recommended Maintenance Schedule	28
Daily Maintenance Checklist	30
Jacking the Sprayer	31
Inspecting the Wheels/Tires	31
Servicing the Air Cleaner	31
Servicing the Engine Oil	33
Greasing the Sprayer	34
Replacing the Fuel Filter	36
Changing Transaxle/Hydraulic Fluid	36
Replacing the Hydraulic Filter	37
Changing the Pump Drive Gearbox Fluid	37
Inspecting the Brakes	37
Adjusting the Parking Brake	37
Adjusting the Front Wheel Toe-In	38
Servicing the Drive Belt	38
Adjusting the Steering Pump Belt	39
Maintaining the Primary Drive Clutch	39
Changing the Spark Plugs	40
Replacing the Fuses	41
Servicing the Battery	41
Cleaning the Suction Strainer	43
Cleaning the Flowmeter	43
Stowing the Boom Extensions	44
Adjusting the Extension Booms	44
Storage	45
Troubleshooting	46
Troubleshooting the Engine and Vehicle	46
Troubleshooting the Spray System	49
Troubleshooting the Spray Pro Monitor	50
The Toro General Commercial Products Warranty ..	52

Introduction

Read this manual carefully to learn how to operate and maintain your product properly. The information in this manual can help you and others avoid injury and product damage. Although Toro designs and produces safe products, you are responsible for operating the product properly and safely.

Whenever you need service, genuine Toro parts, or additional information, contact an Authorized Service Dealer or Toro Customer Service and have the model and serial numbers of your product ready. Figure 1 illustrates the location of the model and serial numbers on the product.

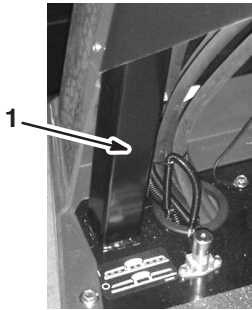

Figure 1

1. Location of the model and serial numbers

Write the product model and serial numbers in the space below:

Model No. _____
Serial No. _____

This manual identifies potential hazards and has special safety messages that help you and others avoid personal injury and even death. **Danger**, **Warning**, and **Caution** are signal words used to identify the level of hazard. However, regardless of the hazard, be extremely careful.

Danger signals an extreme hazard that *will* cause serious injury or death if you do not follow the recommended precautions.

Warning signals a hazard that *may* cause serious injury or death if you do not follow the recommended precautions.

Caution signals a hazard that may cause minor or moderate injury if you do not follow the recommended precautions.

This manual uses two other words to highlight information.

Important calls attention to special mechanical information and **Note**: emphasizes general information worthy of special attention.



Safety

Improper use or maintenance by the operator or owner can result in injury. To reduce the potential for injury, comply with these safety instructions and always pay attention to the safety alert  symbol, which means CAUTION, WARNING, or DANGER—“personal safety instruction.” Failure to comply with the instruction may result in personal injury or death.

Supervisors, operators, and service persons should be familiar with the following standards and publications: (The material may be obtained from the address shown).

- Flammable and Combustible Liquids Code:
ANSI/NFPA 30
- National Fire Protection Association:
ANSI/NFPA #505; Powered Industrial Trucks
National Fire Prevention Association
Barrymarch Park
Quincy, Massachusetts 02269 U.S.A.
- ANSI/ASME B56.8 Personal Burden Carriers
American National Standards Institute, Inc.
1430 Broadway
New York, New York 10018 U.S.A.
- ANSI/UL 558; Internal Combustion Engine Powered Industrial Trucks
American National Standards Institute, Inc.
1430 Broadway
New York, New York 10018 U.S.A.
or
Underwriters Laboratories
333 Pfingsten Road
Northbrook, Illinois 60062 U.S.A.



Safe Operating Practices

	Warning	
The sprayer is an off-highway vehicle only and is not designed, equipped, or manufactured for use on public streets, roads, or highways.		

Supervisor's Responsibilities

- Make sure that operators are thoroughly trained and familiar with the *Operator's Manual*, Engine Manual, and all labels on the sprayer.
- Establish your own special procedures and work rules for unusual operating conditions (e.g. slopes too steep for sprayer operation).

Chemical Safety

 **Warning** 

Chemicals are hazardous and can injure you, bystanders, animals, plants, soils, or other property.

- **Carefully read and follow the chemical manufacturer's instructions for the safe preparation, use, and disposal of the chemical.**
- **Keep chemicals off of your or bystander's skin. If contact should occur, wash it off immediately with clean water and detergent.**
- **Wear goggles and other protective equipment as instructed by the chemical manufacturer.**

- Obtain proper training before using or handling chemicals.
- Use the correct chemical for the job.
- Follow the chemical manufacturer's instructions for the safe application of the chemical.
- Handle chemicals in a well ventilated area.
- Wear goggles and other protective equipment as instructed by the chemical manufacturer. Ensure that as little skin as possible is exposed while using chemicals.
- Have clean water available especially when filling the spray tank.
- Do not eat, drink, or smoke while working with chemicals.
- Always wash your hands and other exposed areas as soon as possible after finishing the work.
- Properly dispose of unused chemicals and chemical containers as instructed by the chemical manufacturer and your local codes.
- Chemicals and fumes in the tanks are dangerous; never enter the tank or place your head over or in the opening.

Before Operating

- Operate the machine only after reading and understanding the contents of this manual.
- **Never** allow children to operate the sprayer. Anyone who operates the sprayer should have a motor vehicle license.

- **Never** allow other adults to operate the sprayer without first reading and understanding the Operator's Manual. Only trained and authorized persons should operate this sprayer. Make sure that all operators are physically and mentally capable of operating the sprayer.
- This sprayer is designed to carry **only you**, the operator. **Never** carry any passengers on the sprayer.
- **Never** operate the sprayer when under the influence of drugs or alcohol. Even prescription drugs and cold medicines can cause drowsiness.
- Do not drive the sprayer when you are tired. Be sure to take occasional breaks. It is very important that you stay alert at all times.
- Become familiar with the controls and know how to stop the engine quickly.
- Keep all shields, safety devices, and decals in place. If a shield, safety device, or decal is malfunctioning, illegible, or damaged, repair or replace it before operating the machine.
- Always wear substantial shoes. Do not operate the machine while wearing sandals, tennis shoes, or sneakers. Do not wear loose fitting clothing or jewelry which could get caught in moving parts and cause personal injury.
- Wearing safety glasses, safety shoes, long pants, and a helmet is advisable and required by some local safety and insurance regulations.
- Avoid driving when it is dark, especially in unfamiliar areas. If you must drive when it is dark, be sure to drive cautiously, use the headlights, and even consider adding additional lights.
- Be extremely careful when operating around people. Always be aware of where bystanders might be and keep them away from the work area.
- Before operating the sprayer, always check the designated areas of the sprayer that are stated in the Pre-Starting section of this manual, page 18. If something is wrong, do **not** use the sprayer. Make sure that the problem is corrected before the sprayer or attachment is operated.
- Ensure that all fluid line connectors are tight and all hoses are in good condition before applying pressure to the system.
- Since gasoline is highly flammable, handle it carefully.
 - Use an approved gasoline container.
 - Do not remove the cap from the fuel tank when the engine is hot or running.
 - Do not smoke while handling gasoline.

- Fill the fuel tank outdoors, and fill it to about 1 inch (25 mm) below the top of the tank (the bottom of the filler neck). Do not overfill it.
- Wipe up any spilled gasoline.

While Operating

⚠
Warning
⚠

Engine exhaust contains carbon monoxide, which is an odorless, deadly poison that can kill you.

Do not run engine indoors or in an enclosed area.

- The operator should remain seated whenever the sprayer is in motion. The operator should keep both hands on the steering wheel whenever possible. Keep your arms and legs within the sprayer body at all times.
- Always watch out for and avoid low overhangs such as tree limbs, door jambs, and over-head walkways. Make sure there is enough room over head to easily clear the sprayer and your head.
- Failure to operate the sprayer safely may result in an accident, tip over of the sprayer, and serious injury or death. Drive carefully. To prevent tipping or loss of control:
 - Use extreme caution, reduce speed, and maintain a safe distance around sand traps, ditches, creeks, ramps, unfamiliar areas, or any areas that have abrupt changes in ground conditions or elevation.
 - Watch for holes or other hidden hazards.
 - Use extra caution when operating the sprayer on wet surfaces, in adverse weather conditions, at higher speeds, or with a full load. Stopping time and distance will increase with a full load.
 - Avoid sudden stops and starts. Do not go from reverse to forward or forward to reverse without first coming to a complete stop.
 - Slow down before turning. Do not attempt sharp turns or abrupt maneuvers or other unsafe driving actions that may cause a loss of sprayer control.
 - Before backing up, look to the rear and ensure that no one is behind you. Back up slowly.
 - Watch out for traffic when you are near or crossing roads. Always yield the right of way to pedestrians and other vehicles. This sprayer is **not** designed for use on streets or highways. Always signal your turns or stop early enough so that other people know what you plan to do. Obey all traffic rules and regulations.

- The electrical and exhaust systems of the sprayer can produce sparks capable of igniting explosive materials. Never operate the sprayer in or near an area where there is dust or fumes in the air which are explosive.
- If you are ever unsure about safe operation, **stop work** and ask your supervisor.

- Do not touch the engine or muffler while the engine is running or soon after it has stopped. These areas may be hot enough to cause burns.
- If the machine ever vibrates abnormally, stop immediately, wait for all motion to stop, and inspect the sprayer for damage. Repair all damage before resuming operation.
- Before getting off of the seat:
 - A. Stop the movement of the machine.
 - B. Place the range selector in Neutral and set the parking brake.
 - C. Turn the ignition key to Off.
 - D. Remove the ignition key.

Note: If the sprayer is stopped on an incline, block the wheels after getting off the sprayer.

Braking



- Slow down before you approach an obstacle. This gives you extra time to stop or turn away. Hitting an obstacle can damage the sprayer and its contents. More important, it can injure you and your passenger.
- Gross Vehicle Weight (GVW) has a major impact on your ability to stop and/or turn. Heavy loads and attachments make a sprayer harder to stop or turn. The heavier the load, the longer it takes to stop.
- Turf and pavement are much more slippery when they are wet. It can take 2 to 4 times as long to stop on wet surfaces as on dry surfaces. If you drive through standing water deep enough to get the brakes wet, they will not work well until they are dry. After driving through water, you should test the brakes to make sure they work properly. If they do not, drive slowly while putting light pressure on the brake pedal. This will dry the brakes out.

Operating on Hills and Rough Terrain

Operating the sprayer on a hill may cause tipping or rolling of the sprayer, or the engine may stall and you could lose headway on the hill. This could result in personal injury.

- Do not accelerate quickly or slam on the brakes when backing down a hill, especially with a load.

- Never drive across a steep hill; always drive straight up or down or go around the hill.
- If the engine stalls or you begin to lose headway while climbing a hill, gradually apply the brakes and slowly back straight down the hill.
- Turning while traveling up or down hills can be dangerous. If you have to turn while on a hill, do it slowly and cautiously. Never make sharp or fast turns.
- Heavy loads affect stability. Reduce the weight of the load and your speed when operating on hills.
- Avoid stopping on hills, especially with a load. Stopping while going down a hill will take longer than stopping on level ground. If the sprayer must be stopped, avoid sudden speed changes, which may initiate tipping or rolling of the sprayer. Do not slam on the brakes when rolling backward, as this may cause the sprayer to overturn.
- The Toro Company strongly recommends installing the optional ROPS Kit when operating on hilly terrain. If you install a ROPS, always wear the seat belt when driving the sprayer.
- Reduce speed and load when operating on rough terrain, uneven ground, and near curbs, holes, and other sudden changes in terrain. Loads may shift, causing the sprayer to become unstable.

Warning

Sudden changes in terrain may cause abrupt steering wheel movement, possibly resulting in hand and arm injuries.

- **Reduce your speed when operating on rough terrain and near curbs.**
- **Grip the steering wheel loosely around the perimeter. Keep your hands clear of the steering wheel spokes.**

Loading

The weight of the cargo can change the sprayer center of gravity and sprayer handling. To avoid loss of control and personal injury, follow these guidelines:

- Reduce the weight of the load when operating on hills and rough terrain to avoid tipping or overturning of the sprayer.
- Liquid loads can shift. This shifting happens most often while turning, going up or down hills, suddenly changing speeds, or while driving over rough surfaces. Shifting loads can cause the sprayer to tip over.
- When operating with a heavy load, reduce your speed and allow for sufficient braking distance. Do not suddenly apply the brakes. Use extra caution on slopes.

- Be aware that heavy loads increase your stopping distance and reduce your ability to turn quickly without tipping over.

Maintenance

- Only permit qualified and authorized personnel to maintain, repair, adjust, or inspect the sprayer.
- Before servicing or making adjustments to the machine, stop the engine, set the parking brake, and remove the key from the ignition to prevent someone from accidentally starting the engine.
- To make sure that the entire machine is in good condition, keep all nuts, bolts, and screws properly tightened.
- To reduce the potential for fire, keep the engine area free of excessive grease, grass, leaves, and accumulation of dirt.
- Never use an open flame to check the level or leakage of fuel or battery electrolyte.
- If the engine must be running to perform a maintenance adjustment, keep your hands, feet, clothing, and any parts of your body away from the engine and any moving parts. Keep everyone away.
- Do not use open pans of fuel or flammable cleaning fluids when cleaning parts.
- **Do not adjust** the ground speed governor. To ensure safety and accuracy, have an Authorized Toro Distributor check the ground speed.
- Keep your body and hands away from pin hole leaks or nozzles that eject high pressure fluid. Use cardboard or paper to find leaks. Fluid escaping under pressure can penetrate skin and cause injury requiring surgery within a few hours by a qualified surgeon or gangrene may result.
- If major repairs are ever needed or assistance is required, contact an Authorized Toro Distributor.
- To be sure of optimum performance and safety, always purchase genuine Toro replacement parts and accessories. Replacement parts and accessories made by other manufacturers could be dangerous. Altering this sprayer in any manner that may affect sprayer operation, performance, durability, or its use, may result in injury or death. Such use could void the product warranty.

Sound Pressure

This unit has a maximum sound pressure level at the operator's ear of 82 dBA, based on measurements of identical machines per Directive 98/37/EC.

Vibration

This unit does not exceed a hand/arm vibration level of 2.5 m/s^2 , based on measurements of identical machines per Directive 98/37/EC.

This unit does not exceed a whole body vibration level of 0.5 m/s^2 , based on measurements of identical machines per Directive 98/37/EC.

Safety and Instruction Decals



Safety decals and instructions are easily visible to the operator and are located near any area of potential danger. Replace any decal that is damaged or lost.



104-7628

1. Read the *Operator's Manual*.

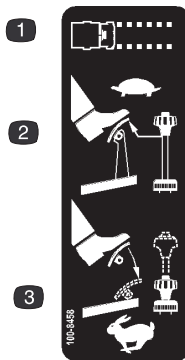

100-8458

1. Machine speed
2. To set the machine to a slow speed, reduce pressure on the accelerator and pull up on the speed limiter.
3. To set the machine to a fast speed, press the accelerator pedal and push down on the speed limiter.

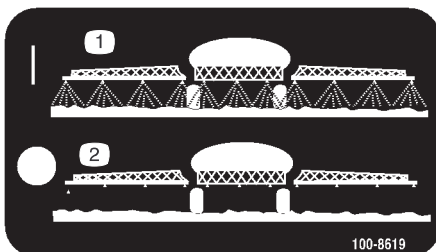

100-8619

1. Spray on
2. Spray off

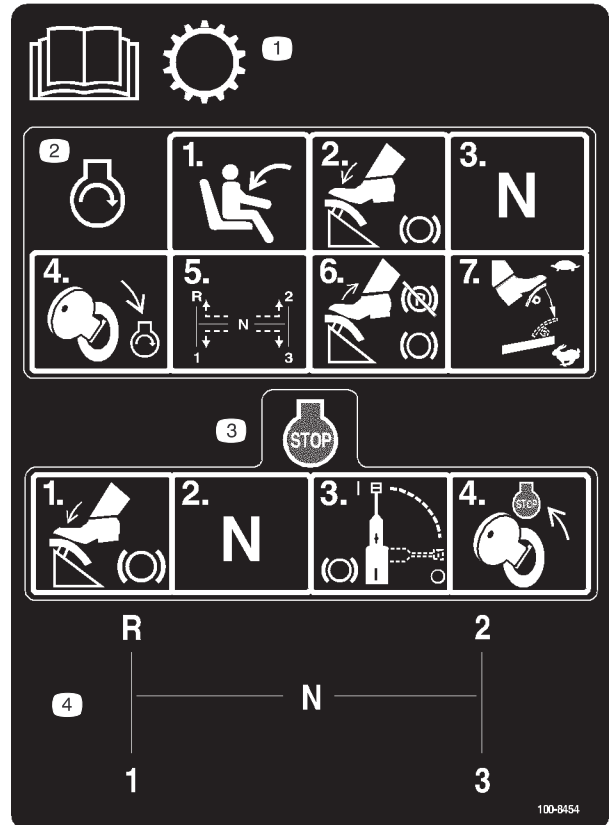

100-8454

1. Read the *Operator's Manual* for information on the transmission.
2. To start the engine, sit on the operator's seat, press the brake, set the range selector to Neutral, turn the ignition key to Engine-start, set the range selector to the desired gear, release the brake pedal and parking brake, and press the accelerator pedal to the desired speed.
3. To stop the engine, press the brake, set the range selector to Neutral, set the brake, and turn the ignition key to Engine-stop.
4. Range selector gear pattern

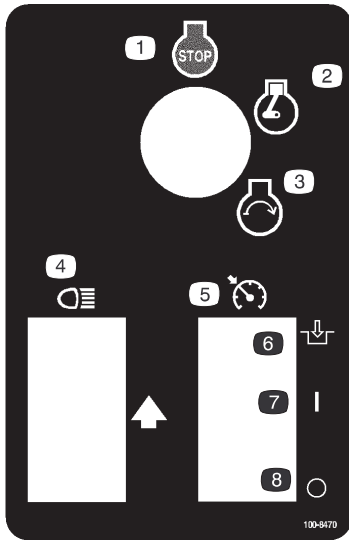

100-8470

- | | |
|-----------------|---------------------------------|
| 1. Engine—stop | 5. Neutral engine speed control |
| 2. Engine—run | 6. Engage |
| 3. Engine—start | 7. On |
| 4. Headlights | 8. Off |

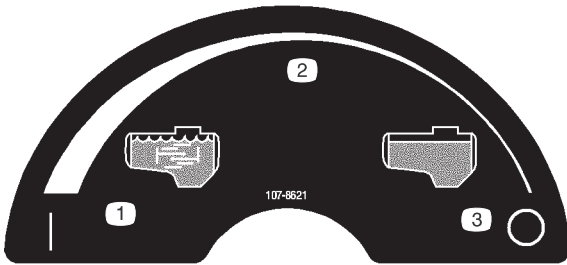

107-8621

- | | |
|--------------------------------|------------------|
| 1. Agitation on | 3. Agitation off |
| 2. Continuous variable setting | |

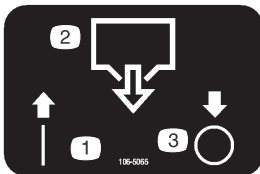

106-5065

- | | |
|---------------|--------|
| 1. On | 3. Off |
| 2. Tank drain | |

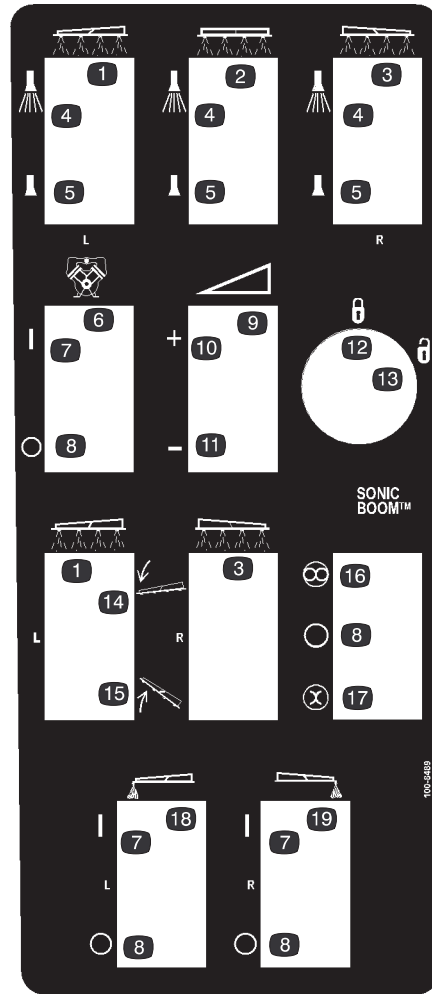

100-8489

- | | |
|--|----------------------------|
| 1. Left boom | 10. Increase |
| 2. Center boom | 11. Decrease |
| 3. Right boom | 12. Locked |
| 4. Spray on | 13. Unlocked |
| 5. Spray off | 14. Lower the boom. |
| 6. Pump | 15. Raise the boom. |
| 7. On | 16. Automatic |
| 8. Off | 17. Manual |
| 9. Continuous variable setting, spray pressure | 18. Left boom foam marker |
| | 19. Right boom foam marker |

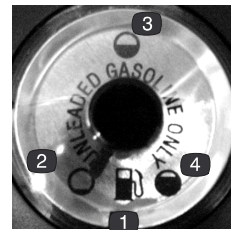

100-8386

- | | |
|----------|--------------|
| 1. Fuel | 3. Half-full |
| 2. Empty | 4. Full |

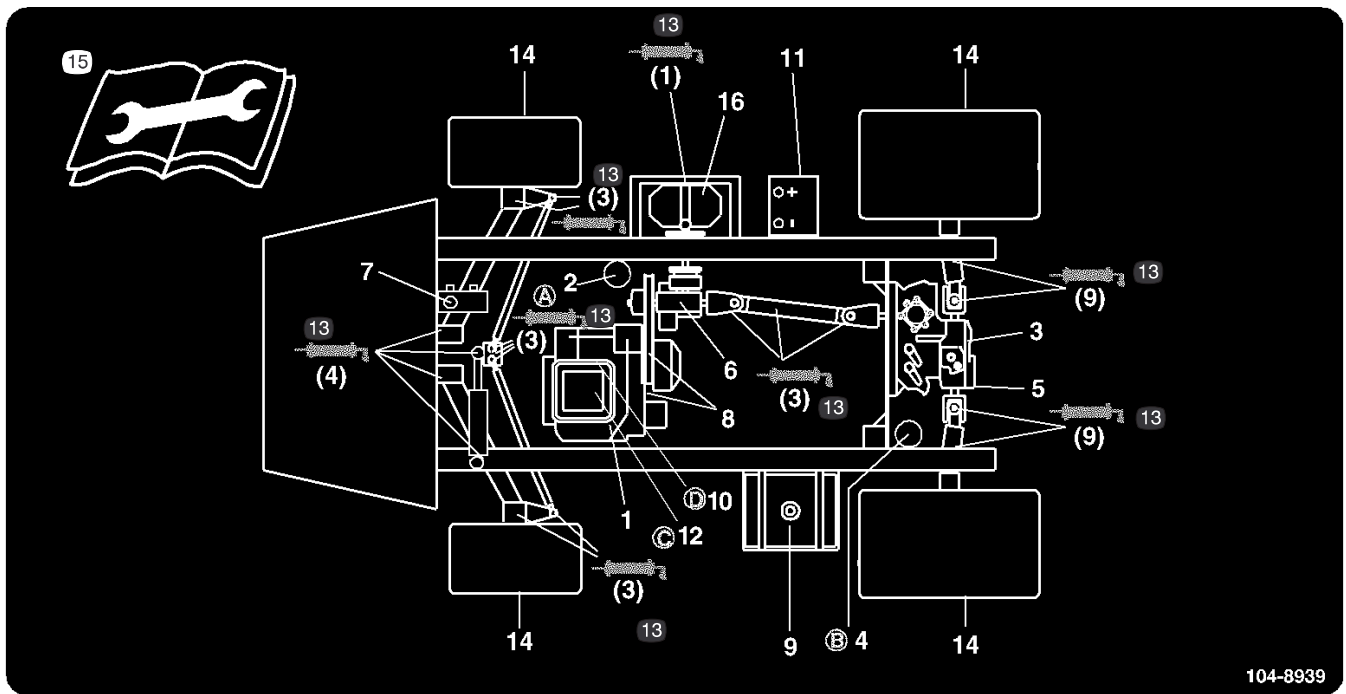

104-8939

104-8939

- | | | | |
|---|------------------------------|-------------------|---|
| 1. Engine oil level (dipstick) | 5. Hydraulic strainer | 10. Fuel filter | 15. Read the instructions before servicing or performing maintenance. |
| 2. Engine oil filter | 6. Gear box fluid level | 11. Battery | 16. Pump |
| 3. Transaxle/hydraulic fluid level (dipstick) | 7. Brake fluid | 12. Air cleaner | |
| 4. Transaxle hydraulic filter | 8. Belts, steering and drive | 13. Grease | |
| | 9. Fuel, unleaded only | 14. Tire pressure | |

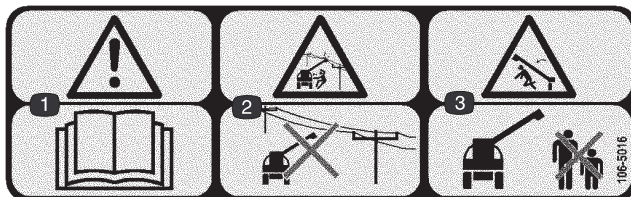

106-5016

- | | |
|---|--|
| 1. Warning—read the <i>Operator's Manual</i> . | 3. Crushing hazard, boom—keep bystanders a safe distance from the machine. |
| 2. Electric shock hazard, overhead power lines—stay away from overhead power lines. | |

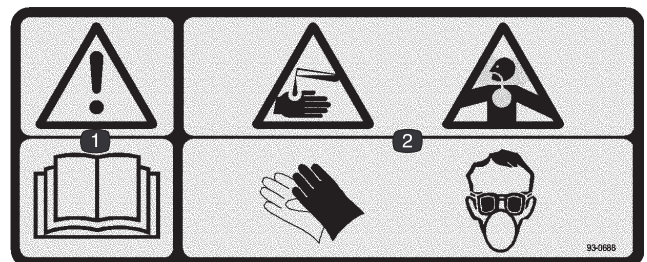

93-0688

- | |
|--|
| 1. Warning—read the <i>Operator's Manual</i> . |
| 2. Caustic liquid/chemical burn and toxic gas inhalation hazards—wear hand, skin, eye, and respiratory protection. |



100-8621

1. Warning—read the *Operator's Manual*.
2. Tipping Hazard—drive slowly over rough terrain and when turning.
3. The maximum load is 1290 lb (585 kg), the operator and accessory weight is 350 lb (158 kg), the vehicle weight is 1260 lb (572 kg), and the maximum gross vehicle weight is 3500 lb (1589 kg).
4. Falling and arm/leg injury hazards—do not carry passengers and keep arms and legs inside of the vehicle at all times.
5. To stop the engine, press the brake, move the range selector to Neutral, set the parking brake, release the brake pedal, turn the ignition key to Engine-stop, and remove the key.

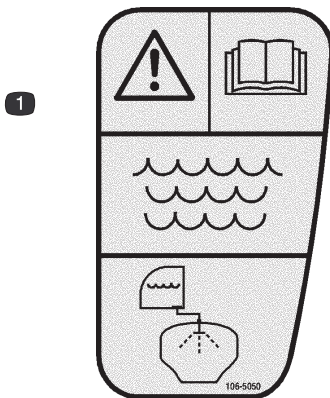

106-5050

1. Warning—read the *Operator's Manual*; use fresh, clean water for rinsing the tank.

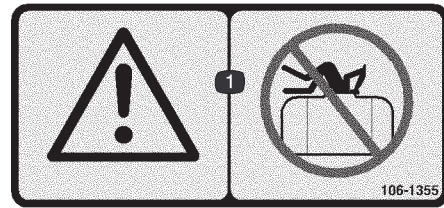

106-1355

1. Warning—do not enter the tank.

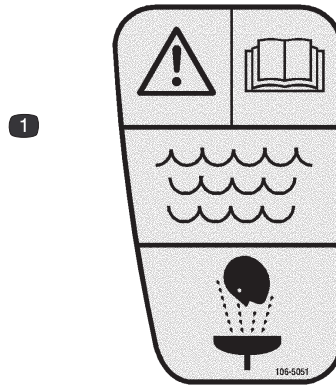

106-5051

1. Warning—read the *Operator's Manual*; use fresh, clean water for first-aid washing.

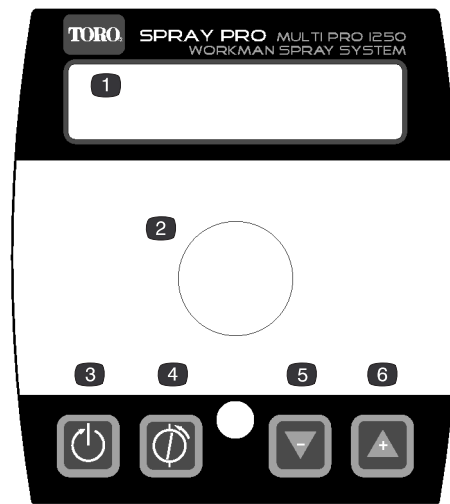

108-3312

- | | |
|-------------------|--------------|
| 1. LCD screen | 4. Calibrate |
| 2. Selection dial | 5. Decrease |
| 3. Reset | 6. Increase |

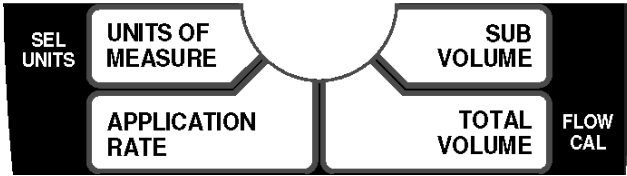
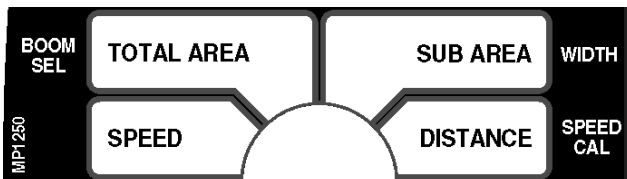

108-3307

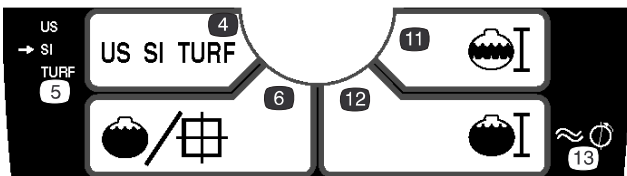
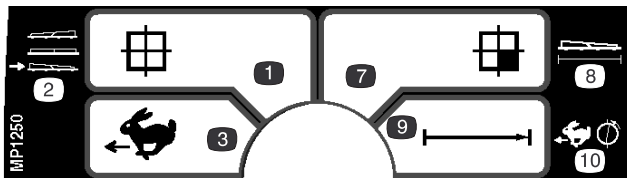

108-3309

- | | |
|---------------------|---------------------------|
| 1. Total area | 8. Width |
| 2. Boom select | 9. Distance |
| 3. Speed | 10. Speed calibration |
| 4. Units of Measure | 11. Sub volume |
| 5. Select units | 12. Total volume |
| 6. Application rate | 13. Flowmeter calibration |
| 7. Sub area | |

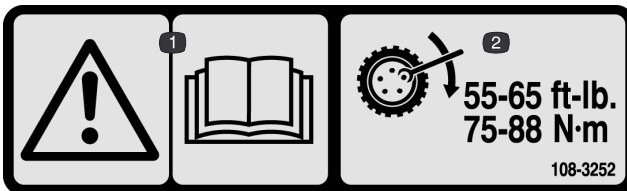

108-3252

- Warning—read the *Operator's Manual*.
- Torque lug nuts to 55-65 ft-lb (75-88 N·m).

Specifications

Note: Specifications and design are subject to change without notice.

Base weight	1,920 lb (870 kg))
Weight with standard spray system, empty, without operator	1,920 lb (870 kg))
Weight with standard spray system, full, without operator	3,395 lb (1,539 kg)
Maximum gross vehicle weight (GVW) (on level ground)	3,643 lb (1,652 kg)
Tank capacity (includes the CE 5% overflow)	175 US gallons (662 L)
Overall width without standard spray system	56 inches (142 cm)

Overall length with standard spray system	120 inches (305 cm)
Overall height with standard spray system to the top of the tank	37.5 inches (95.25 cm)
Overall height with standard spray system to the top of the booms stored in the X pattern	74 inches (188 cm)
Ground clearance	4.5 inches (11.4 cm)
Wheel base	62 inches (157 cm)

Optional Equipment

The Toro Company has optional equipment and accessories that you can purchase separately and install on your sprayer. Contact your Authorized Service Dealer for a complete list of optional equipment that is currently available for your sprayer.

Setup

Note: Determine the left and right sides of the machine from the normal operating position.

Loose Parts

Note: Use the chart below to verify that all parts have been shipped.

Description	Qty.	Use
90 degree fitting	1	Install the anti-siphon fill receptacle.
Quick coupler	1	
Hose adapter	1	
Fill receptacle bracket	1	
Flange-head bolt, 5/16 x 3/4 inch	1	
Anti-siphon hose	1	
Spray Pro Monitor	1	Install the Spray Pro monitor.
Spray Pro Decal	1	
Bracket	1	
Flange-head bolt, 3/4 inch	2	
Flange nut, 1/4 inch	2	
Knob	2	
Washer	2	
Carriage bolt	2	
Key	2	Use in the ignition switch.
Operator's Manual	1	Read before operating the machine.
Engine Operator's Manual	1	
Operator Video	1	Watch before operating the machine.
Parts Catalog	1	Use for ordering replacement parts.
Registration Card	1	Complete and return to Toro.
Predelivery Inspection Form	1	Complete and file in your customer history portfolio.

Installing the Anti-siphon Fill Receptacle

1. Place the fill receptacle bracket over the threaded hole in the tank and secure it with a flange-head bolt (5/16 x 3/4 inch) (Fig. 2).

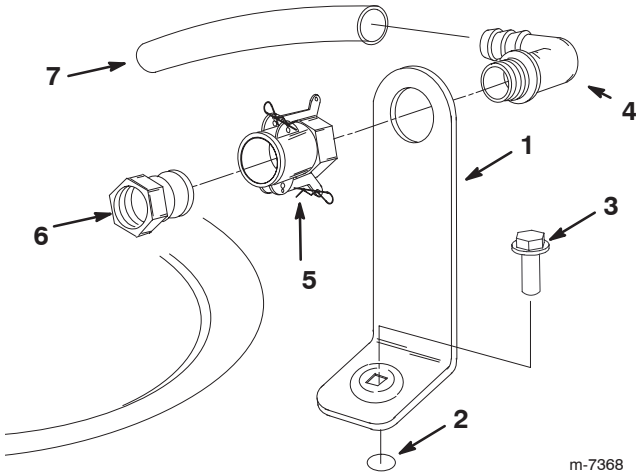

Figure 2

- | | |
|---------------------------------|----------------------------|
| 1. Fill receptacle bracket | 4. 90 degree elbow fitting |
| 2. Threaded hole in the tank | 5. Quick coupler |
| 3. Flange bolt, 5/16 x 3/4 inch | 6. Hose adapter |
| | 7. Anti-siphon hose |

2. Place the threaded end of the 90 degree elbow fitting through the bracket and thread the quick coupler onto it, securing it to the bracket (Fig. 2).

Note: Install the fitting with the open end pointing toward the tank opening so the water will arc into the tank when you fill it.

3. Install the hose adapter into the quick coupler (Fig. 2).
4. Lock the adapter into place by swinging the levers toward the adapter and then secure them with the hairpin cotters (Fig. 2).
5. Install the anti-siphon hose on the barbed end of the 90 degree elbow fitting (Fig. 2).

Important Do not lengthen the hose to allow contact with the tank fluids.

Installing the Spray Pro Monitor

1. Install the monitor bracket on the dash (Fig. 3) using 2 flange-head bolts (1/4 x 3/4 inch) and 2 flange nuts (1/4 inch).

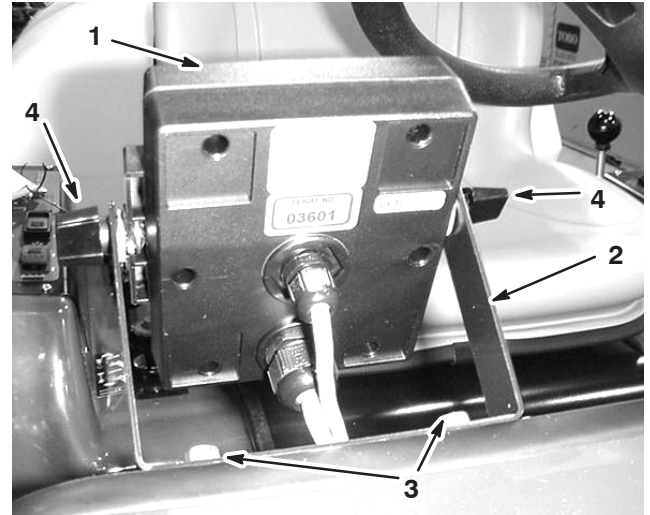

Figure 3

- | | |
|----------------------|--------------------------------------|
| 1. Spray Pro monitor | 3. Flange-head bolts, 1/4 x 3/4 inch |
| 2. Bracket | 4. Knob |

2. Loosely install the 2 carriage bolts, rubber washers, and knobs on the bracket as illustrated in Figure 3 and 4.

Note: Install the carriage bolts and rubber washers inside of the bracket and the knobs on the outside.

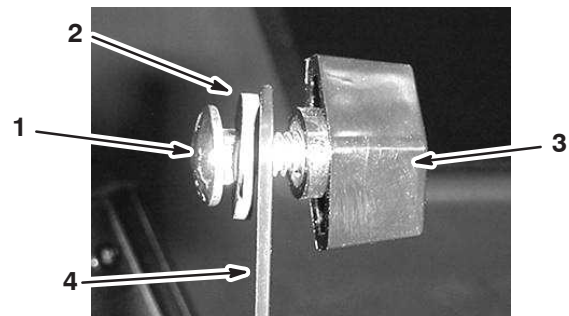

Figure 4

- | | |
|------------------|------------|
| 1. Carriage bolt | 3. Knob |
| 2. Rubber washer | 4. Bracket |

3. Remove the large grommet from the hole in the dash and thread the cables on the monitor through the grommet and the dash.
4. Install the grommet into the dash.
5. Apply the Spray Pro Decal to the monitor. Be sure to orient the decal as shown in Figure 27.

6. Install the Spray Pro monitor over the carriage bolt heads (Fig. 3) and tighten the knobs to secure it.
7. Connect the Spray Pro wire connectors to the wire connectors located under the dash (Fig. 5).

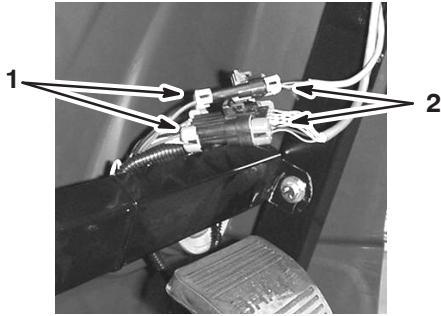

Figure 5

1. Connectors from the sprayer
2. Connectors from the monitor

Before Operating

Checking the Engine Oil

The engine is shipped with oil in the crankcase; however, the level of oil must be checked before you first start the engine and after you have run it.

1. Position the machine on a level surface.
2. Remove the dipstick and wipe it with a clean rag (Fig. 6). Insert the dipstick into the tube and make sure it is seated fully. Remove the dipstick and check the oil level.

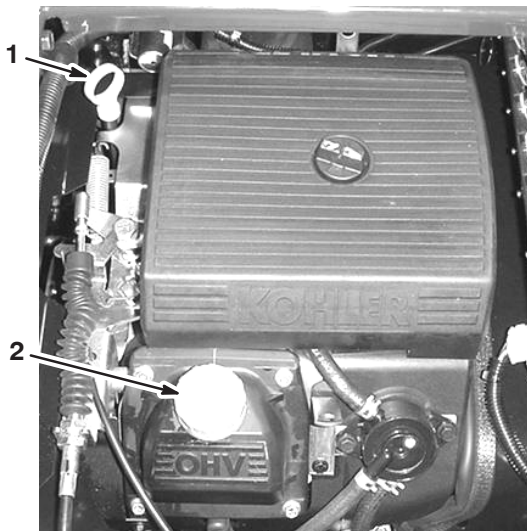

Figure 6

1. Dipstick
2. Filler cap

3. If the oil level is low, remove the filler cap from the valve cover (Fig. 6) and pour oil into the opening until the oil level is up to the Full mark on the dipstick; refer to Servicing Engine Oil, page 33, for the proper oil type and viscosity. Add the oil slowly and check the level often during this process. **Do not overfill.**
4. Install the dipstick firmly in place.

Checking the Tire Pressure

Check the tire pressure every 8 hours or daily to ensure proper levels. Fill the tires to 18 psi (124 kPa). Also, check the tires for wear or damage.

Adding Fuel



Danger



In certain conditions, gasoline is extremely flammable and highly explosive. A fire or explosion from gasoline can burn you and others and can damage property.

- Fill the fuel tank outdoors, in an open area, when the engine is cold. Wipe up any gasoline that spills.
- Do not fill the fuel tank completely full. Add gasoline to the fuel tank until the level is 1 inch (25 mm) below the bottom of the filler neck. This empty space in the tank allows gasoline to expand.
- Never smoke when handling gasoline and stay away from an open flame or where gasoline fumes may be ignited by a spark.
- Store gasoline in an approved container and keep it out of the reach of children. Never buy more than a 30-day supply of gasoline.
- Always place gasoline containers on the ground away from your sprayer before filling.
- Do not fill gasoline containers inside a vehicle or on a truck or trailer bed because interior carpets or plastic truck bed liners may insulate the container and slow the loss of any static charge.
- When practical, remove gas-powered equipment from the truck or trailer and refuel the equipment with its wheels on the ground.
- If this is not possible, then refuel such equipment on a truck or trailer from a portable container, rather than from a gasoline dispenser nozzle.
- If a gasoline dispenser nozzle must be used, keep the nozzle in contact with the rim of the fuel tank or container opening at all times until fueling is complete.

Recommended Gasoline

Use fresh, clean, **unleaded** regular gasoline suitable for automotive use (87 pump octane minimum). Leaded gasoline may be used if unleaded regular is not available.

Important Never use gasoline containing **methanol**, gasoline containing more than 10% ethanol, gasoline additives, or white gas because engine fuel system damage could result.

Filling the Fuel Tank

The fuel tank capacity is approximately 6 US gallons (21 L).

Note: The fuel tank cap contains a gauge which shows the fuel level; check it frequently.

1. Shut the engine off and set the parking brake.
2. Clean the area around the fuel tank cap (Fig. 7).

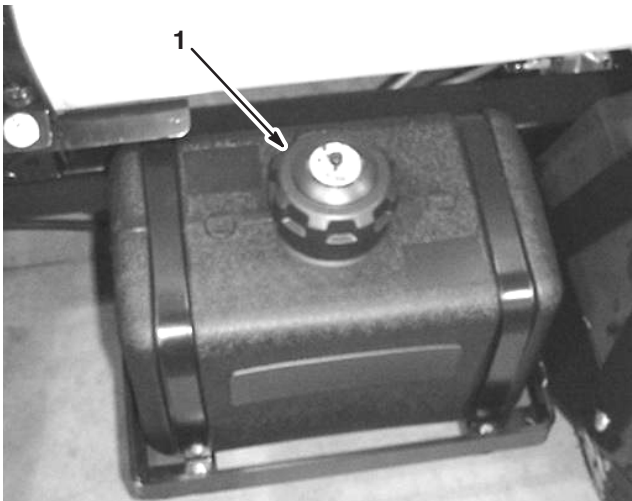

Figure 7

1. Fuel tank cap

3. Remove the fuel tank cap.
4. Fill the tank to about one inch below the top of the tank, (bottom of the filler neck). This space in the tank allows gasoline to expand. **Do not overfill.**
5. Install the fuel tank cap securely.
6. Wipe up any fuel that may have spilled.

Checking the Air Intake Screen

Check and clean as necessary the air intake screen on the front of the engine every 8 operating hours.

Checking the Brake Fluid

The brake fluid reservoir is shipped from the factory filled with DOT 3 brake fluid. Check the level before starting the engine each day.

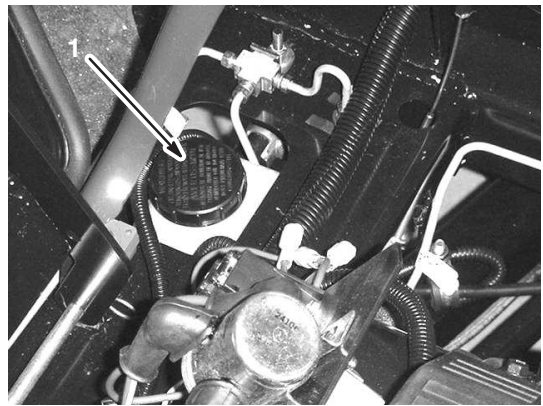

Figure 8

1. Brake fluid reservoir

1. Position the sprayer on a level surface, set the parking brake, stop the pump, stop the engine, and remove the ignition key.
2. The fluid level should be up to the Full line on the reservoir (Fig. 9).

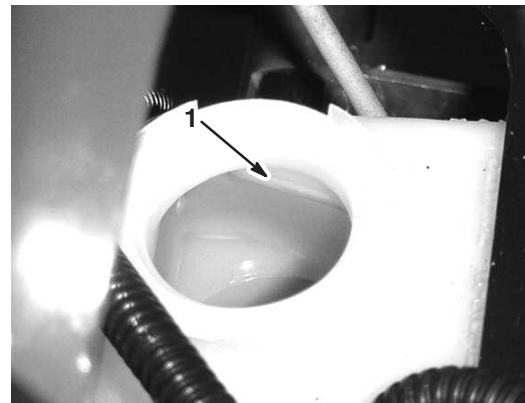

Figure 9

1. Full line

3. If the fluid level is low, clean the area around the reservoir cap, remove the cap, and fill the reservoir to the proper level. **Do not overfill it.**

Checking the Transaxle/Hydraulic Fluid

1. Position the sprayer on a level surface, set the parking brake, stop the pump, stop the engine, and remove the ignition key.
2. Remove the transaxle dipstick and wipe it with a clean rag (Fig. 10).

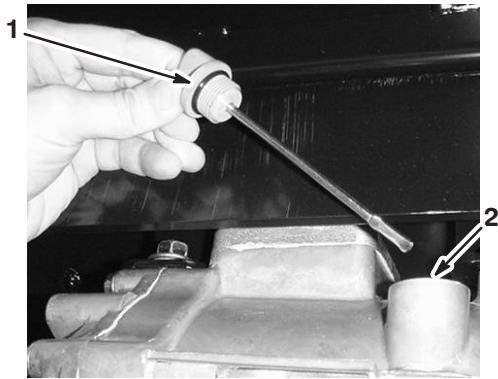

Figure 10

1. Dipstick
2. Fill hole

Important Be very careful not to get dirt or other contaminants into the opening when checking the transmission oil.

3. Insert the dipstick into the tube and make sure it is seated fully. Remove the dipstick and check the oil level.
4. The transaxle fluid level should be at the top of the flat portion of the dipstick. If it is not, fill the reservoir with the appropriate fluid; refer to Changing the Transaxle/Hydraulic Fluid, page 36.
5. Install the dipstick firmly in place.

Filling the Fresh Water Tank

The sprayer is equipped with a fresh water tank (Fig. 11) for you to wash chemicals off of your skin, eyes, or other surfaces in the case of accidental exposure. Always fill the fresh water tank with clean water before handling or mixing any chemicals.

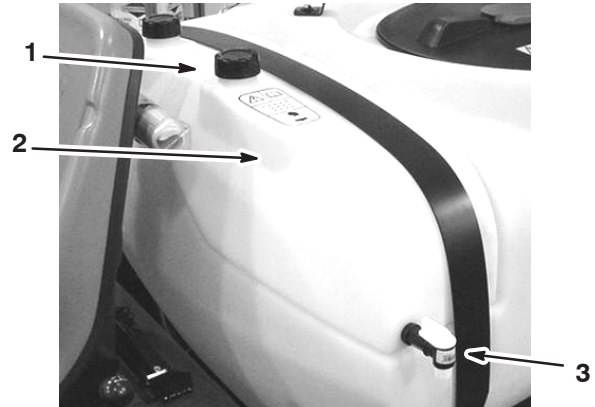

Figure 11

1. Filler cap
2. Fresh water tank
3. Spigot

To open the fresh water tank spigot, turn the lever on the spigot.

Operation

Note: Determine the left and right sides of the machine from the normal operating position.

Think Safety First

Please carefully read all of the safety instructions and decals in the safety section. Knowing this information could help you or bystanders avoid injury.

Vehicle Controls

Accelerator Pedal

The accelerator pedal (Fig. 12) gives you the ability to vary ground speed of the sprayer. Pressing the pedal increases ground speed. Releasing the pedal will slow the sprayer and the engine will idle.



Figure 12

- 1. Accelerator pedal
- 2. Brake pedal

Brake Pedal

Use the brake pedal to stop or slow the sprayer (Fig. 12).

Caution

Brakes can become worn or can be misadjusted resulting in personal injury.

If brake pedal travels to within 1 inch (2.5 cm) of the sprayer floor board, the brakes must be adjusted or repaired.

Parking Brake

The parking brake is a large lever to the right of the seat. (Fig. 13). Engage the parking brake whenever you plan on leaving the seat to prevent accidental movement of the sprayer. To engage the parking brake, pull up and back on the lever. To disengage, push it forward and down. If the sprayer is parked on a steep grade, apply the parking brake and place blocks at the downhill side of the wheels.

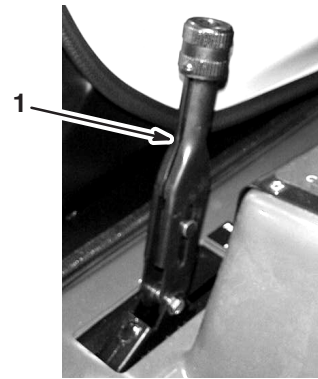

Figure 13

- 1. Parking brake lever

Speed Limiter

The speed limiter is a large knob located to the right of the seat (Fig. 14). It allows you to set the maximum downward travel of the accelerator pedal, thereby limiting the maximum speed of the sprayer.

Note: The vehicle controls the application rate based on your speed and you do not need to keep a constant speed to apply at a constant rate.

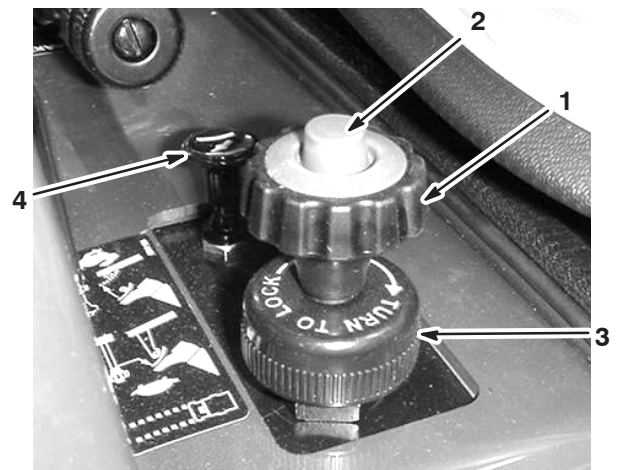

Figure 14

- 1. Speed limiter knob
- 2. Speed limiter button
- 3. Locking ring
- 4. Choke control

Set the speed limiter as follows:

1. Press down on the accelerator pedal to obtain the desired speed.
2. Press the button on top of the speed limiter knob and pull up on it until you feel it touch the accelerator pedal, then release the button (Fig. 14).
3. To fine tune the setting, turn the knob in or out as needed.
4. Once you have it set, you can lock it at that setting by turning the locking ring at the base of the speed limiter clockwise until it stops (Fig. 14). To release this lock, turn the locking ring counter clockwise until it is loose.
5. To release the speed limiter, press the button on the knob and lower it as far as possible.

Choke Control

The choke control is a small knob to the right of the seat (Fig. 14). To start a cold engine, pull the choke control up. After the engine starts, regulate the choke to keep the engine running smoothly. As soon as possible, push the control down to the Off position. A warm engine requires little or no choking.

Range Selector

The range selector, located to the left of the seat, has 5 positions: 3 forward speeds, Neutral, and Reverse (Fig. 15). The engine will start only when the range selector is in the Neutral position. You must also fully press the brake with the sprayer stopped to change gears.

Important Do not shift out of or change gears while the vehicle is moving. It could damage the transmission.

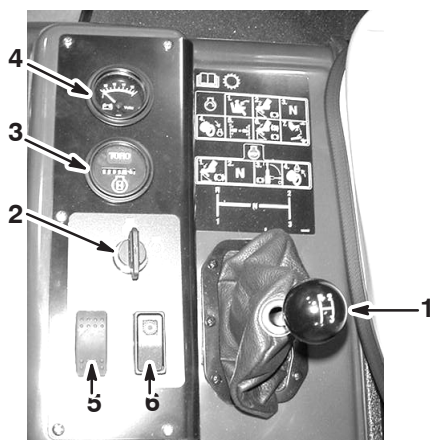

Figure 15

- | | |
|--------------------|--|
| 1. Range Selector | 5. Headlight switch |
| 2. Ignition switch | 6. Neutral engine speed control switch |
| 3. Hour meter | |
| 4. Voltmeter | |

Ignition Switch

The ignition switch (Fig. 15), used to start and stop the engine, has 3 positions: Stop, Run, and Start. Rotate the key clockwise to the Start position to start the engine and release it to the Run position when started. Rotate the key to the Stop position to stop the engine.

Hour Meter

The hour meter (Fig. 15) indicates the total number of hours the engine has run. The hour meter starts to function whenever the key is turned to the Run position.

Voltmeter

The voltmeter (Fig. 15) indicates the level of charge in the battery. When the battery is fully charged, the voltmeter will read in the center of the dial when the key is in the Run position with the engine off. When the engine is running the voltmeter needle should be to the right.

Headlight Switch

Toggle the switch to operate the headlights (Fig. 15). Push it forward to turn the lights on and rearward to turn them off.

Neutral Engine Speed Control Switch

When the range selector is in the Neutral position, you can use the accelerator pedal to speed up the engine, then push this switch forward to set the engine at that speed. This is necessary to run attachments such as the hand sprayer (Fig. 15).

Fuel Gauge

The fuel gauge (Fig. 16) shows the amount of fuel in the tank.

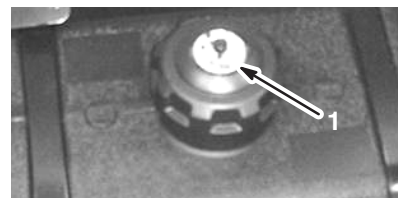

Figure 16

1. Fuel gauge

Pre-Starting Checks

Check the following items each time you begin using the sprayer for the day:

- Check the tire pressure.

Note: These tires are different than car tires; they require less pressure to minimize turf compaction and damage.

- Check all fluid levels and add the appropriate amount of specified fluids, if any are found to be low.
- Check the brake pedal operation.
- Check to see that the lights are working.
- Turn the steering wheel to the left and right to check steering response.
- Check for oil leaks, loose parts, and any other noticeable malfunctions. Make sure the engine is off and all moving parts have stopped before checking for oil leaks, loose parts, and other malfunctions.

If any of the above items are not correct, notify your mechanic or check with your supervisor before taking the sprayer out for the day. Your supervisor may want you to check other items on a daily basis, so ask what your responsibilities are.

Starting the Engine

1. Sit in the operator's seat, insert the key into the ignition switch, and rotate the key clockwise to the Run position.
2. Press the brake and move the range selector to the Neutral position.
3. Ensure that the pump switch is in the Off position.
4. If the engine is cold, pull the choke knob up.

Important Do not use the choke if the engine is warm.

5. Turn the key to the Start position until the engine starts.

Important Do not hold the key in the Start position for more than 10 seconds. If the engine has not started after 10 seconds, wait 1 minute before trying again. Do not attempt to push or tow the sprayer to start the engine.

6. Once the engine starts, push the choke knob down slowly.

Driving the Sprayer

1. Press the brake pedal.
2. Push the parking brake lever forward to release it.
3. Move the range selector into the desired range.
4. Press the accelerator pedal to drive or press the brake to stop.

Note: Stopping distance may vary depending on the sprayer load and speed.

Stopping the Engine

1. Press the brake to stop the sprayer.
2. Pull the parking brake lever up and back to set it.
3. Move the range selector out of gear into the Neutral position.
4. Turn the ignition key to the Stop position.
5. Remove the key from the switch to prevent accidental starting.

New Sprayer Break-In

To provide proper performance and long sprayer life, follow these guidelines for the first 100 operating hours:

- Check the fluid and engine oil levels regularly and be alert for indications of overheating in any component of the sprayer.
- After starting a cold engine, let it warm up for about 15 seconds before accelerating.
- Avoid hard braking situations for the first several hours of new sprayer break-in operation. New brake linings may not be at optimum performance until several hours of use has caused the brakes to become burnished (broken-in).
- Avoid racing the engine.
- Vary the sprayer speed during operation. Avoid fast starts and quick stops.
- Refer to the Maintenance section for any special low hour checks.

Transporting the Sprayer

For moving the sprayer long distances, use a trailer. Secure the sprayer to the trailer. Figure 17 illustrates the front tie-down points.

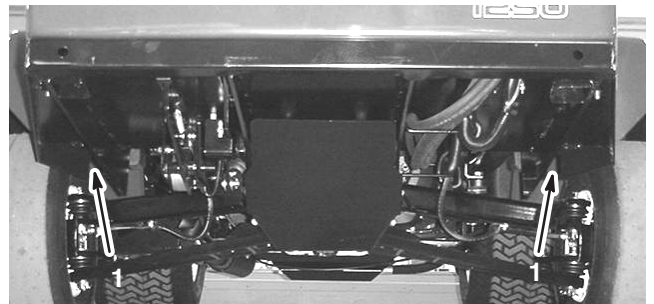

Figure 17

1. Tie down points

The rear tie-down points are two steel loops under the back of the frame just in front of the adjustable boom frame.

Towing the Sprayer

In case of an emergency, the sprayer can be towed for a short distance. However, we do not recommend this as a standard procedure.

Warning

Towing at excessive speeds could cause a loss of steering control, resulting in personal injury.

Never tow the sprayer faster than 5 mph (8 kph).

Towing the sprayer is a two person job. If the machine must be moved a considerable distance, transport it on a truck or trailer; refer to Transporting the sprayer, page 19.

1. Affix a tow line to the frame.
2. Put the range selector in the Neutral position and release the parking brake.
3. Tow the sprayer at less than 5 mph (8 kph).

Sprayer Controls and Components

Master Boom Switch

The master boom switch allows you to start or stop the spray operation. Press the switch with your foot to enable or disable the spray system (Fig. 18). When the master switch is off, the Spray Pro screen reads “Hold.”

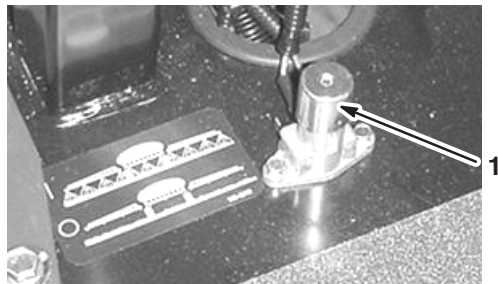

Figure 18

1. Master boom switch

Boom Switches

The boom switches are located at the front of the control panel to the right of the seat (Fig. 19). Toggle each switch forward to turn the corresponding boom section on and rearward to turn them off. When the switch is turned on, a light on the switch illuminates. These switches will only affect the spray system when the master boom switch is on.



Figure 19

1. Boom switches
2. Pump switch
3. Application rate switch
4. Rate lockout key

Pump Switch

The pump switch is located on the control panel to the right of the seat (Fig. 19). Toggle this switch forward to run the pump or rearward to stop the pump.

Application Rate Switch

The application rate switch is located on the control panel to the right of the seat (Fig. 19). Press and hold the switch forward to increase the spray system pressure, or press and hold it rearward to decrease pressure.

Rate Lockout Key Switch

The rate lockout key switch is located on the control panel to the right of the seat (Fig. 19). Turn the key counterclockwise to the locked position to disable the application rate switch, thereby keeping anyone from accidentally changing the application rate. Turn the key clockwise to the unlocked position to enable the application rate switch.

Boom Lift, Sonic Boom, and Foam Marker Switch Locations

If you install the electric boom lift, sonic boom, and foam marker kit, you will add switches to the control panel for controlling their operation. The sprayer comes with plastic plugs in these locations.

Rate Control Valve

This valve, located behind the tank (Fig. 20), controls the amount of fluid that is routed to the booms by directing fluid flow to the booms or the bypass hose to the tank. You can control this valve in two ways: the application rate switch or manually. To control it manually, you need to disconnect the wire connector on the valve, then you can rotate the knob on top of the valve to manually obtain the desired pressure.

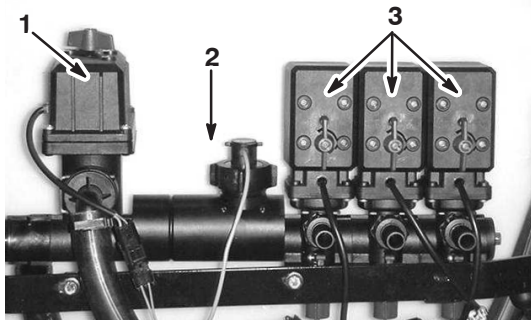

Figure 20

1. Rate control valve
2. Flowmeter
3. Boom valves

Flowmeter

The flowmeter measures the flow rate of the fluid for use by the Spray Pro™ system (Fig. 20).

Boom Valves

These valves turn the three booms on or off (Fig. 20). If you do not have a boom installed or do not want a boom to be able to be turned on, you can manually operate each valve by disconnecting the wire connector in the valve, then rotate the knob on the valve clockwise to turn the valve off or counterclockwise to turn it on.

Boom Bypass Valves

The boom bypass valves redirect the fluid flow for a boom to the tank when you turn off the boom section. You can adjust these valves to ensure that the boom pressure remains constant no matter how many booms are on. Refer to Adjusting the Boom Bypass Valves, page 25.

Agitation Control Valve

This valve is located on the right side of the tank (Fig. 21). Turn the knob on the valve to the 9 o'clock position to turn on the tank agitation and to the 3 o'clock position to turn off the tank agitation.

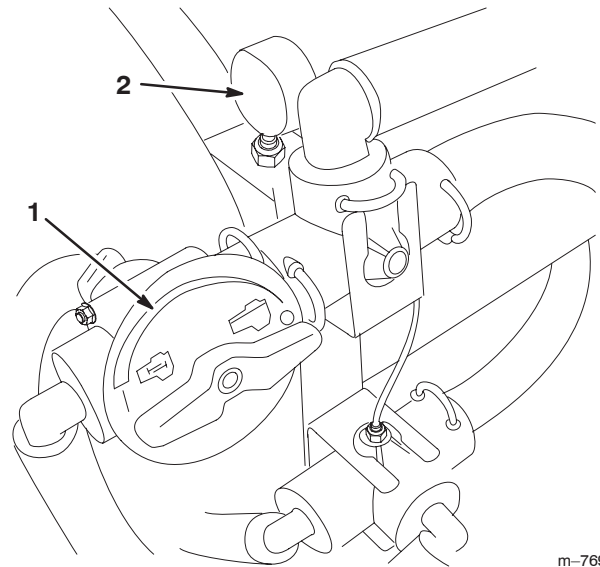

m-7697

Figure 21

1. Agitation control valve
2. Pressure gauge

For agitation to work, the pump must be on and the engine must be running above an idle. If you stop the sprayer and need agitation on, place the range selector in the Neutral position, set the parking brake, press the accelerator pedal to the floor, and turn the neutral engine speed control on.

Pressure Gauge

The pressure gauge is located to the right of the tank (Fig. 21). This gauge shows the pressure of the fluid in the system in psi and kPa.

Pump

The pump is located near the front of the tank on the right side (Fig. 22).

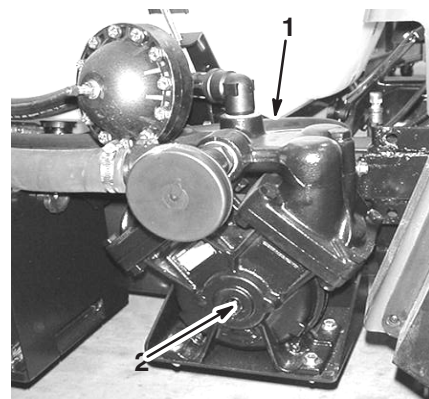

Figure 22

1. Pump
2. Grease fitting

Tank Drain Handle

The tank drain handle is located on top of the tank (Fig. 23). Pull the handle out to drain the tank.

Important Pull the handle gently out until it stops. Do not pull too hard or you may damage it.

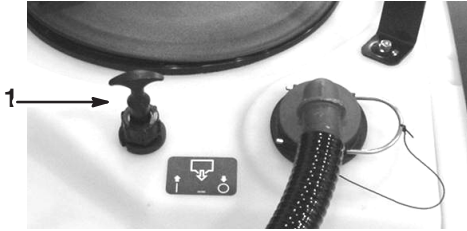

Figure 23

1. Tank drain handle

Tank Cover

The tank cover is located in the center of the top of the tank (Fig. 24). To open it, turn off the engine, then turn the front half of the cover to the left and swing it open. You can remove the strainer inside for cleaning. To seal the tank, close the cover and rotate the front half toward the right.



Figure 24

1. Tank cover
2. Anti-siphon fill receptacle

Anti-siphon Fill Receptacle

To the front of the tank cover is a hose receptacle with a threaded fitting, a 90 degree barbed fitting, and a short hose which you can direct toward the tank opening (Fig. 24). This receptacle allows you to connect a water hose to it and fill the tank with water without contaminating the hose with the chemicals in the tank.

Important Do not lengthen the hose to allow contact with the tank fluids.

Fresh Water Tank

The fresh water tank is located at the front, left side of the tank (Fig. 25). It supplies you with a source of fresh water for you to wash chemicals off of your skin, eyes, or other surfaces in the case of accidental exposure. Always fill the fresh water tank with clean water before handling or mixing any chemicals.

To open the fresh water tank spigot, turn the lever on the spigot.

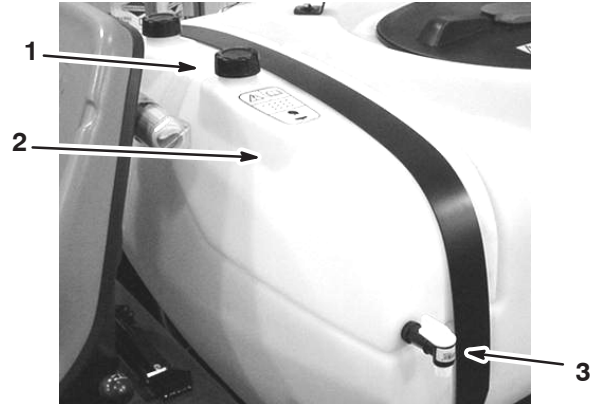

Figure 25

1. Filler cap
2. Fresh water tank
3. Spigot

Rinse Tank

The rinse tank is located at the front, right side of the tank (Fig. 26). If you install the optional Rinse Kit, you can fill this tank with fresh water and rinse the main tank.



Figure 26

1. Rinse tank (for use with the optional rinse kit)

Spray Pro™ Monitor

The Spray Pro monitor displays and monitors various system performance data such as vehicle speed and application rates. **It does not control the application rate.**

The monitor has an LCD screen that displays the data you select, a selection dial, and 4 buttons for calibrating the monitor (Fig. 27).

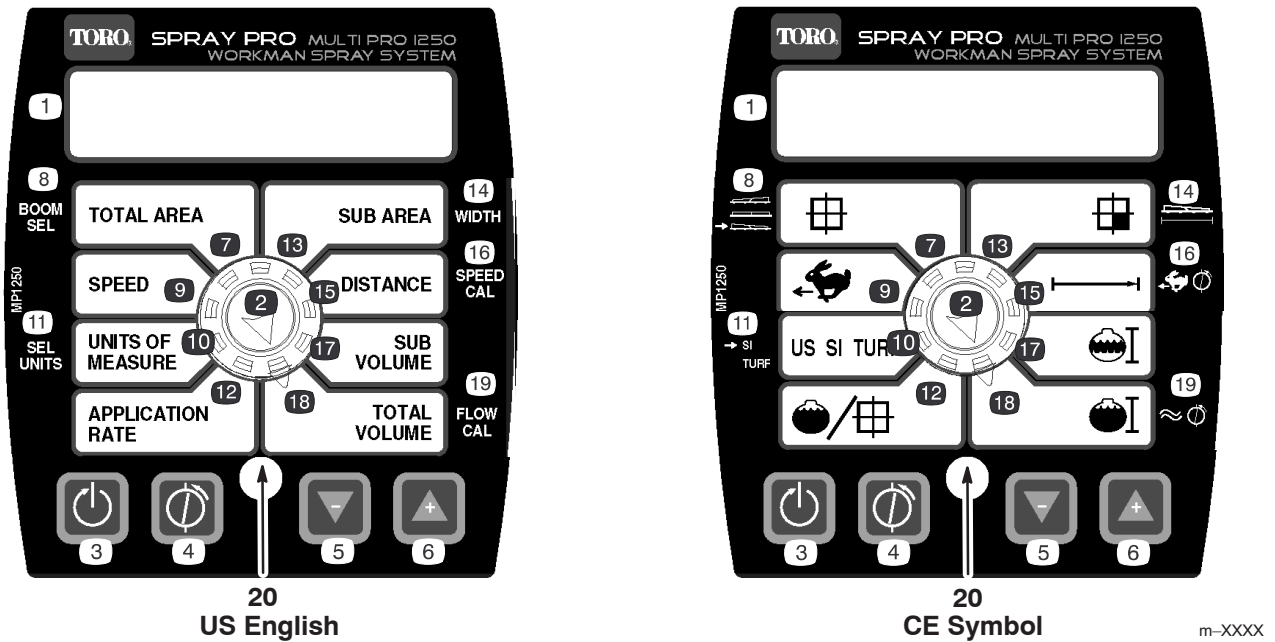

Figure 27

- | | | | |
|----------------------------------|---------------------------------|----------------------|---------------------------|
| 1. LCD screen | 6. Increase, calibration button | 11. Select units | 16. Speed calibration |
| 2. Selection dial | 7. Total area | 12. Application rate | 17. Sub volume |
| 3. Reset, calibration button | 8. Boom selection | 13. Sub Area | 18. Total volume |
| 4. Calibrate, calibration button | 9. Speed | 14. Width | 19. Flowmeter calibration |
| 5. Decrease, calibration button | 10. Units of measure | 15. Distance | 20. LED |

Selection Dial

The selection dial contains the following positions:

- Total area

Displays the total acres (US), hectares (SI), or sq feet (TURF) that you have covered since you last pressed the Reset calibration button for this setting.
- Speed

Displays the ground speed in miles per hour (if the Units of Measure is set to US or TURF) or kilometers per hour (if the Units of Measure is set to SI).
- Units of Measure

Displays the current measurement unit selection as follows:

 - US (United States measuring system)
 - SI (metric system)
 - TURF (as US but the volumes are in US gallons per 1000 sq ft instead of US gallons per acre)
- Application Rate

Displays the application rate in US gallons per acre (US), liters pre hectare (SI), or US gallons per 1000 sq ft (TURF).
- Sub Area

Displays the total acres (US), hectares (SI), or sq feet (TURF) that you have covered since you last pressed the Reset calibration button for this setting, without affecting the Total Area display. If you press the Reset calibration button, the Sub Volume also resets.
- Distance

Displays the distance you have traveled in feet (US and TURF) or meters (SI) since you last pressed the the Reset calibration button for this setting.
- Sub Volume

Displays the total volume in US gallons (US and TURF) or liters (SI) that you have applied since you last pressed the Reset calibration button for this setting, without affecting the Total Volume display. If you press the Reset calibration button, the Sub Area also resets.

- Total Volume

Displays the total volume in US gallons (US and TURF) or liters (SI) that you have applied since you last pressed the Reset calibration button for this setting.

Calibration Buttons

The monitor has the following buttons:

- Reset
Resets the Total Volume, Sub Volume, Distance, Total Area, and Sub Area display settings to 0.
- Calibrate
Used to enter and exit the calibration mode.
- Decrease
Reduces values displayed on the screen during calibration.
- Increase
Increases values displayed on the screen during calibration.

Calibrating the Spray Pro Monitor

The Spray Pro monitor has a calibration mode that allows you to change various settings to customize the display and calibrate the monitor to your needs. You can calibrate or change the following settings:

- Boom Width
- Units of Measure
- Speed
- Flowmeter

Setting the Boom Width

The default settings for the boom widths are 80 inches (200 cm) for the right and left booms and 60 (150 cm) for the center boom. This is based on 4 nozzles on the right and left booms and 3 on the center boom all spaced 20 inches (50.8 cm) apart. If you change the spacing of the nozzles, you should change the boom width to reflect your changes as follows:

1. Stop the sprayer and set the parking brake.
2. Set the master boom switch to the Off position. The monitor displays “HOLD”.
3. Press and hold the Calibrate button until the monitor displays “CAL HOLD” and the red light on the monitor illuminates.

4. Turn the selection dial to the Total Area position.
5. Use the Increase or Decrease calibration buttons to select the boom for which you wish to change the width, where 1 is the left boom, 2 is the center boom, and 3 is the right boom.
6. Turn the selection dial to the Sub Area position.
7. Use the Increase or Decrease calibration buttons to change the boom width as needed.
8. Repeat steps 4 through 7 for the other booms as needed.
9. Press the Calibrate button until the red light turns off. You can also exit the calibration mode by driving the sprayer.

Setting the Units of Measure

The default setting for the units of measure is US. You can also change the units to SI (metric) or TURF.

1. Stop the sprayer and set the parking brake.
2. Set the master boom switch to the Off position. The monitor displays “HOLD”.
3. Press and hold the Calibrate button until the monitor displays “CAL HOLD” and the red light on the monitor illuminates.
4. Turn the selection dial to the Units of Measure position.
5. Use the Increase or Decrease calibration buttons to select desired units of measure.
6. Press the Calibrate button until the red light turns off. You can also exit calibration mode by driving the sprayer.

Calibrating the Flowmeter

The Spray Pro comes approximately calibrated for the flowmeter. Complete the following procedure to fine tune the flowmeter calibration:

1. Set the parking brake.
2. Fill the sprayer tank with a known quantity of water, at least 100 US gallons (380 L).
Note: Do not rely on the marks on the side of the tank for measuring the water for this procedure. They are approximate measurements, but not accurate enough for this calibration.
3. Set the pump switch to the On position to start the pump.
4. Set all three boom switches and the master boom switch to the On position. Run the booms only until the air is purged from the line, then turn them off using the master boom switch.
5. Turn the selection dial to the Total Volume position.

6. Press and hold the Reset calibration button until the display reads “0”.
7. Set the master boom switch to the On position and run the booms until all the water is out of the tank, then stop them using the master boom switch.
8. Compare the volume displayed on the monitor to the volume of water you put into the tank.
 - If the volumes are the same, you do not need to calibrate the monitor any further.
 - If the values are different, continue with the rest of this procedure.
9. With the selection dial set to the Total Volume position, press and hold the Calibrate button until the monitor displays “CAL HOLD” and the red light on the monitor illuminates.

The display will alternate between the total volume value and the flow calibration value.
10. When the total volume value is displayed, use the Increase or Decrease calibration buttons to change it to the amount of water you put in the tank.
11. When the display begins alternating again, the flow calibration value will have changed; write this number down and save it. This is the calibration value for your sprayer.
12. Press the Calibrate button until the red light turns off. You can also exit calibration mode by driving the sprayer.

Calibrating the Speed Sensor

The Spray Pro comes approximately calibrated for the speed sensor. Complete the following procedure to fine tune the speed sensor calibration:

1. Check and fill all tires; refer to Checking Tire Pressure, page 14.
2. Fill the fresh water tank.
3. Fill the sprayer tank half-full of water.
4. Select a straight, flat track of ground that is similar to your turf conditions.

Note: Using a road or other paved surface could cause an inaccurate reading when you later drive the sprayer on turf.
5. Measure 500 feet, marking both the start and end points.
6. Position the sprayer about 30 feet behind the starting point.
7. Set the pump and the master boom switches to the Off position. The monitor should display “HOLD”.
8. Turn the selection dial to the Distance position.

9. Press and hold the Reset calibration button until the display reads “0”.
10. Drive the machine from the start point you marked to the 500 ft end point. Ensure that you come up to speed before reaching the start point and do not stop or brake until after you pass the end point. When you reach the start point, press the master boom switch to start the distance tracking with the monitor.
11. When you reach the end point, set the master boom switch to the Off position to stop the monitor.
12. Look at the distance displayed on the monitor.
 - If it reads “500 feet”, you do not need to calibrate the monitor any further.
 - If it does not read “500 feet,” continue with the rest of this procedure.
13. Set the parking brake.
14. With the selection dial set to the Distance position, press and hold the Calibrate button until the monitor displays “CAL HOLD” and the red light on the monitor illuminates.

The display will alternate between the speed calibration value and the distance value.
15. When the distance value is displayed, use the Increase or Decrease calibration buttons to change it to 500 feet.
16. When the display begins alternating again, the speed calibration value will have changed; write this number down and save it. This is the calibration value for your sprayer.
17. Press the Calibrate button until the red light turns off. You can also exit calibration mode by driving the sprayer.

Resetting an OFL Condition

If the monitor reads “OFL”, it indicates that you have exceeded the monitor screen dimensions. Press and hold the Reset calibration button to set the display to 0.

Adjusting the Boom Bypass Valves

After you install your booms and nozzles, if necessary, and before using the sprayer for the first time, adjust the boom bypass valves so that the pressure and application rate remains the same for all booms when you turn one or more booms off.

Select an open flat area to perform this procedure.

1. Fill the spray tank with clean water.
2. Put the extension booms down, if installed.

3. Set the parking brake and start the engine .
4. Set the dial on the Spray Pro monitor to Application Rate.
5. Place the range selector in the Neutral position.
6. Press the accelerator to the floor and set the neutral engine speed control switch to the On position.
7. Set the pump switch to the On position to start the pump.
8. Set all three boom switches and the master boom switch to the On position.
9. Use the application rate switch to adjust the pressure as read on the pressure gauge until it is in the range for the nozzles you installed on the booms (typically 50 psi).
10. Record the reading on the pressure gauge.
11. Turn off one of the booms using the appropriate boom switch.
12. Adjust the boom bypass valve (Fig. 28) under the boom control valve for the boom you turned off until the pressure reading on the gauge is the same as it was in step 9.

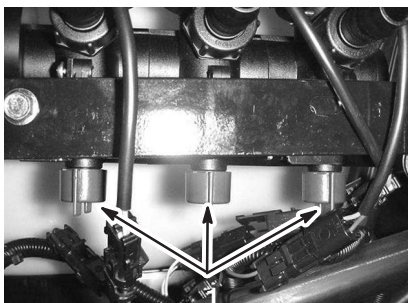

Figure 28

1. Boomy bypass valves

13. Turn the boom on.
14. Repeat steps 11 through 13 for the other booms.
15. Drive the sprayer at the desired speed while spraying and turn each boom off individually. The pressure on the gauge should not change much.

Operating the Sprayer

To operate the sprayer you first fill the spray tank, then apply the solution to the work area, and finally clean the tank. It is important that you complete all three of these steps in succession to avoid damaging the sprayer. For example, do not mix and add chemicals in the spray tank at night and then spray in the morning. This would lead to separation of the chemicals and possible damage to the sprayer components.



Caution



Chemicals are hazardous and can cause personal injury.

- **Read the directions on the chemical labels before handling the chemicals and follow all manufacturer recommendations and precautions.**
- **Keep chemicals away from your skin. Should contact occur, wash the affected area thoroughly with soap and clean water.**
- **Wear goggles and any other protective equipment recommended by the chemical manufacturer.**

Filling the Spray Tank

Important Ensure that the chemicals you will be using are compatible for use with Viton (see the manufacturer's label; it should indicate if it is not compatible). Using a chemical that is not compatible with Viton will degrade the o-rings in the sprayer, causing leaks.

1. Stop the sprayer on a level surface, move the range selector to the Neutral position, stop the engine, and set the parking brake.
2. Determine the amount of water needed to mix the amount of chemical you need as prescribed by the chemical manufacturer.
3. Open the lid on the spray tank.
4. Add 3/4 of the required water to the spray tank using the anti-siphon fill receptacle.

Important Always use fresh clean water in the spray tank. Do not pour concentrate into an empty tank.

5. Start the engine, press the accelerator pedal to the floor, and set the neutral engine speed control to the On position.
6. Set the pump switch to the On position.
7. Turn the agitation control valve to the 9 o'clock position to start agitation in the tank.
8. Add the proper amount of chemical concentrate to the tank, as directed by the chemical manufacturer.

Important If you are using a wettable powder, mix the powder with a small amount of water to form a slurry before adding it to the tank

9. Add the remaining water to the tank.

Applying Chemicals

Important In order to ensure that your solution remains well mixed, use the agitation feature whenever you have solution in the tank. For agitation to work, the pump must be on and the engine must be running above an idle. If you stop the vehicle and need agitation on, place the range selector in the Neutral position, set the parking brake, press the accelerator pedal to the floor, and turn the neutral engine speed control on.

Note: This procedure assumes that the pump is on from the Filling the Spray Tank procedure.

1. Swing the booms into position.
2. Set the master boom switch to the Off position. The Spray Pro monitor will display “HOLD.”
3. Set the individual boom switches, as needed, to the On positions.
4. Drive to the location where you will be spraying.
5. Turn the Spray Pro selection dial to the Application Rate position and use the application rate switch to achieve the desired rate.
6. Set the master boom switch to the On position to begin spraying.

Note: When the tank is nearly empty, the agitation may cause foaming in the tank. In this case, turn the agitation control valve to the 3 o'clock position to turn it off. Alternatively, you can use an anti-foaming agent in the tank.

7. When finished spraying, set the master boom switch to the Off position to turn off all booms, then set the pump switch to the Off position.

Operating Tips

- Do not overlap areas that you have previously sprayed.
- Watch for plugged nozzles. Replace all worn or damaged nozzles.
- Use the master boom switch to stop the spray flow before stopping the sprayer. Once stopped, use the neutral engine speed control to hold the engine speed up to keep the agitation running.
- You will obtain better results if the sprayer is moving when you turn the booms on.
- Watch for changes in the application rate that may indicate that your speed has changed beyond the range of the nozzles or there is a problem with the spray system.

Cleaning the Sprayer

Important You must always empty and clean the sprayer immediately after each use. Failure to do so may cause the chemicals to dry or thicken in the lines, clogging the pump and other components.

Note: Using the optional Rinse Kit will change this procedure.

1. Stop the sprayer, set the parking brake, place the range selector in the Neutral position, and turn off the engine.
2. Use the tank drain knob to drain any unused material from the tank and dispose of it according to local codes and the material manufacturer's instructions.
3. Fill the tank with at least 50 US gallons (190 L) of clean fresh water and close the cover.

Note: You can use a cleaning/neutralizing agent in the water as needed. On the final rinse, use only clean, clear water.

4. Start the engine.
5. With the range selector in the Neutral position, press the accelerator pedal to the floor and set the neutral engine speed control switch to the On position.
6. Ensure that the agitation control valve is in the On position.
7. Set the pump switch to the On position and use the application rate switch to increase the pressure to a high setting.
8. Set the master boom switch and boom control switches to the On positions to begin spraying.
9. Allow all of the water in the tank to spray out through the nozzles.
10. Check the nozzles to ensure that they are all spraying correctly.
11. Set the master boom switch to the Off position, set the pump switch to the Off position, and stop the engine.
12. Repeat steps 3 through 11 at least 2 more times to ensure that the spray system is fully cleaned.
13. Clean the strainer; refer to Cleaning the Suction Strainer, page 43.

Important If you used wettable powder chemicals, clean the strainer after each tank.

14. Using a garden hose, spray off the outside of the sprayer with clean water.
15. Remove the nozzles and clean them by hand. Replace damaged or worn nozzles.

Maintenance

Note: Determine the left and right sides of the machine from the normal operating position.

Recommended Maintenance Schedule

Important Refer to your **engine operator's manual** for additional maintenance procedures.

Maintenance Service Interval	Maintenance Procedure
After first 8 hours	<ul style="list-style-type: none"> • Torque the wheel lug nuts. • Replace the hydraulic filter. • Check the drive belt tension. • Check the steering pump belt.
8 hours	<ul style="list-style-type: none"> • Check the engine oil. • Check the tire pressure. • Clean the suction strainer³
25 hours	<ul style="list-style-type: none"> • Clean and oil the foam air cleaner element.²
50 hours	<ul style="list-style-type: none"> • Check the battery electrolyte level. • Check the battery cable connections. • Clean the suction strainer. • Change the engine oil after the initial 50 hours of use.
100 hours	<ul style="list-style-type: none"> • Change the engine oil (includes synthetic oil).¹ • Replace the engine oil filter. • Lubricate all grease fittings. • Replace the fuel filter. • Inspect the brakes. • Clean the engine rotating screen.² • Replace the paper cleaner element.² • Inspect the brake and parking brake. • Inspect the condition and wear of the tires. • Torque the wheel lug nuts. • Check the front wheel toe-in. • Check the steering pump belt. • Check the operation of the Neutral gear shift position.
200 hours	<ul style="list-style-type: none"> • Change the spark plugs. • Check the parking brake. • Check the shift cables. • Check the drive belt.

Maintenance Service Interval	Maintenance Procedure
400 hours or yearly	<ul style="list-style-type: none"> • Change the pump drive gearbox fluid. • Clean and lubricate the primary drive clutch • Inspect the fuel lines. • Have an Authorized Toro Service Distributor check the diaphragms and check valves in the pump and replace them if necessary. • Complete all yearly maintenance procedures specified in the engine operator's manual. • Inspect the pump diaphragm and replace it if necessary. • Inspect the pressure dampener bladder and replace it if necessary. • Inspect the pump check valves and replace them if necessary. • Inspect the O-rings in the valve assemblies and replace them if necessary.
800 hours or yearly	<ul style="list-style-type: none"> • Change the transaxle/hydraulic fluid. • Replace the hydraulic filter.

¹More often when operating under heavy load or high temperatures

²More often in dusty, dirty conditions

³More often when using wettable powers

Daily Maintenance Checklist

Duplicate this page for routine use.

Maintenance Check Item	For the week of:						
	Mon.	Tues.	Wed.	Thurs.	Fri.	Sat.	Sun.
Check the brake and parking brake operation.							
Check the gear shift/neutral operation.							
Check the fuel level.							
Check the engine oil level.							
Check the transaxle oil level.							
Inspect the air filter.							
Inspect the engine cooling fins.							
Check any unusual engine noises.							
Check any unusual operating noises.							
Check the tire pressure.							
Check for fluid leaks.							
Check the instrument operation.							
Check the accelerator operation.							
Clean the suction strainer.							
Check toe-in.							
Lubricate all grease fittings. ¹							
Touch up and damaged paint.							

¹Immediately after every washing, regardless of the interval listed

Notation for Areas of Concern

Inspection performed by:		
Item	Date	Information
1		
2		
3		
4		
5		
6		
7		
8		
9		
10		
11		
12		



Caution



If you leave the key in the ignition switch, someone could accidentally start the engine and seriously injure you or other bystanders.

Remove the key from the ignition and disconnect the wire(s) from the spark plug(s) before you do any maintenance. Set the wire(s) aside so that it does not accidentally contact the spark plug(s).

Jacking the Sprayer

Whenever the engine is run for routine maintenance and/or engine diagnostics, the rear wheels of the sprayer should be 1 inch (25 mm) off of the ground with the rear axle supported on jack stands.



Danger



A sprayer on a jack may be unstable and slip off of the jack, injuring anyone beneath it.

- Do not start the engine while the sprayer is on a jack.
- Always remove the key from the ignition before getting off of the sprayer.
- Block the tires when the sprayer is on a jack.

The jacking point at the front of the sprayer is under the A-arms (Fig. 29)

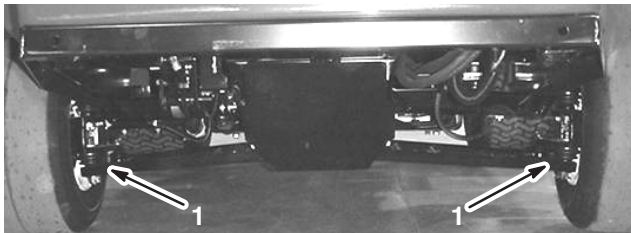

Figure 29

1. Front jacking points

The jacking point at the rear of the sprayer is on the rear frame support, between the angle welds (Fig. 30).

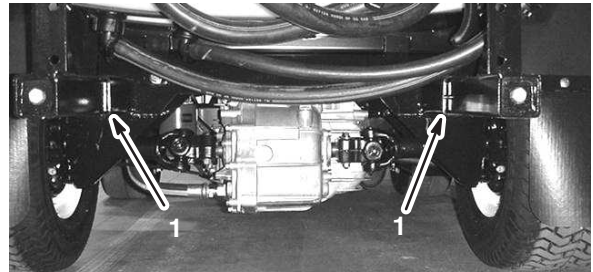

Figure 30

1. Rear jacking points

Inspecting the Wheels/Tires

Check the wheels to ensure that they are mounted securely after the first 8 operating hours and then every 100 hours thereafter. Torque the front bolts and the rear lug nuts to 50–55 ft-lb (68–74 N·m).

Check the tire condition at least every 100 hours of operation. Operating accidents, such as hitting curbs, can damage a tire or rim and also disrupt wheel alignment, so inspect tire condition after an accident.

Servicing the Air Cleaner

Foam Element: Clean and oil after every 25 operating hours, or yearly, whichever occurs first.

Paper Element: Replace after every 100 operating hours or yearly, whichever occurs first.

Note: Service the air cleaner more frequently (every few hours) if operating conditions are extremely dusty or sandy.

Removing the Foam and Paper Elements

1. Set the parking brake, stop the pump, stop the engine, and remove the ignition key.
2. Release the latch on the back of the seat and lift the seat forward.
3. Clean around the air cleaner to prevent dirt from getting into the engine and causing damage (Fig. 31).

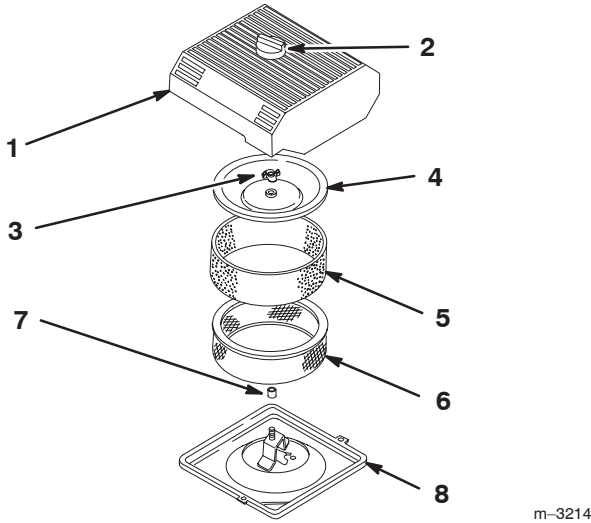

Figure 31

- | | |
|----------------------|---------------------|
| 1. Air cleaner cover | 5. Foam element |
| 2. Knob | 6. Paper element |
| 3. Cover nut | 7. Rubber seal |
| 4. Cover | 8. Air cleaner base |

4. Loosen the knob on the air cleaner cover and remove the cover (Fig. 31).
5. Carefully slide the foam element off the paper element (Fig. 31).
6. Unscrew the cover nut and remove the cover and paper element (Fig. 31).

Cleaning the Foam Element

1. Wash the foam element in liquid soap and warm water.
2. When the element is clean, rinse it thoroughly.
3. Dry the element by squeezing it in a clean cloth.
4. Put one or two ounces of oil on the element (Fig. 32).

Important Replace the foam element if it is torn or worn.

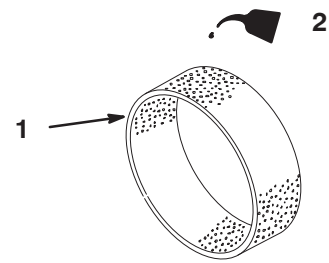

Figure 32

1. Foam element
2. Oil

5. Squeeze the element to distribute the oil.

Checking the Paper Element

Inspect the paper element for tears, an oily film, damage to the rubber seal, excessive dirt, or other damage (Fig. 33). If any of these conditions exist, replace the filter.

Important Do not clean the paper element with pressurized air or liquids, such as solvent, gas, or kerosene.

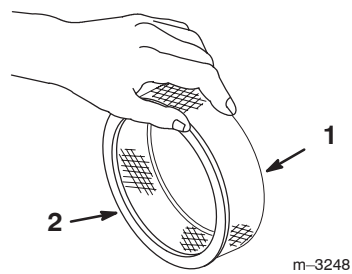

Figure 33

1. Paper element
2. Rubber seal

Important To prevent engine damage, always operate the engine with the complete foam and paper air cleaner assembly installed.

Installing the Foam and Paper Elements

1. Carefully slide the foam element onto the paper air cleaner element (Fig. 31).
2. Slide the air cleaner assembly and cover onto the long rod.
3. Install the cover nut finger-tight against the cover (Fig. 31).

Note: Ensure that the rubber seal is flat against the air cleaner base and cover.

4. Install the air cleaner cover and knob (Fig. 31).
5. Close and latch the seat.

Servicing the Engine Oil

Change the engine oil and oil filter after every 100 operating hours.

Crankcase capacity is 2.1 qt (2.0 l) with the filter



Use high-quality engine oil that meets the following specifications:

API Classification Level REquired: SJ, JK, SL or higher
 Preferred oil: SAE 10W30 (above 0 F)
 Alternate oil: SAE 5W30 (below 32 F)

Toro Premium Engine Oil is available from your distributor in either 15W-40 or 10W-30 viscosity. See the *Parts Catalog* for part numbers

Changing the Engine Oil

1. Start the engine and let it run for five minutes. This warms the oil so it drains better.
2. Set the parking brake, stop the pump, stop the engine, and remove the ignition key.
3. Release the latch on the back of the seat and lift the seat forward.

	Caution	
<p>Components under the seat will be hot if the sprayer has been running. If you touch hot components you may be burned.</p> <p>Allow the sprayer to cool before performing maintenance or touching components under the hood.</p>		

4. Place a pan below the oil drain.
5. Remove the drain plug (Fig. 34).

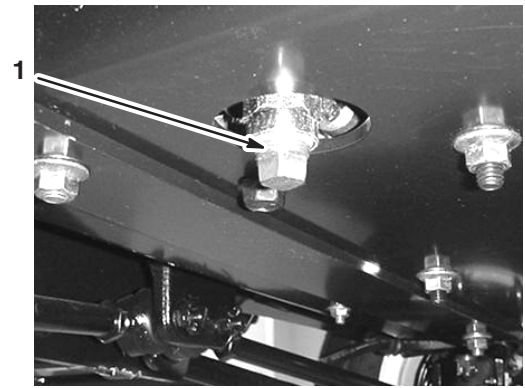

Figure 34

1. Oil drain plug

6. When the oil has drained completely, replace the drain plug and torque it to 10 ft-lb (13.6 N-m).
7. Dispose of the used oil at a certified recycling center.
8. Slowly pour approximately 80% of the specified amount of oil into the oil filler tube (Fig. 35).

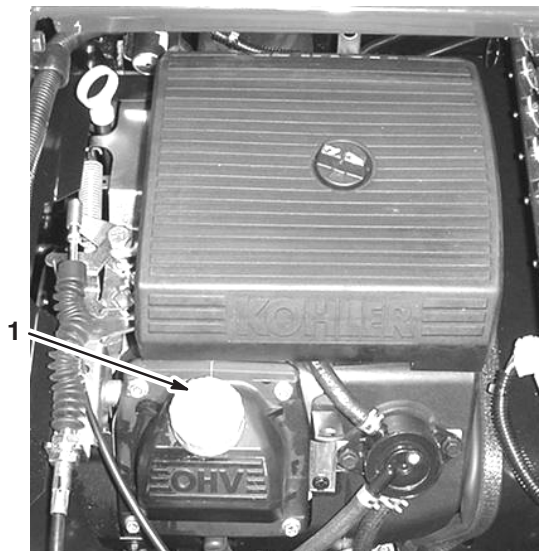

Figure 35

1. Oil filler tube

9. Check the oil level; refer to Checking the Engine Oil Level, page 14.
10. Slowly add additional oil to bring the oil level to the full mark on the dipstick.

Important Overfilling the crankcase with oil may cause engine damage.

Changing the Engine Oil Filter

1. Drain the oil from the engine; refer to Changing Oil, page 33, steps 1 through 7.
2. Remove the old filter (Fig. 36).

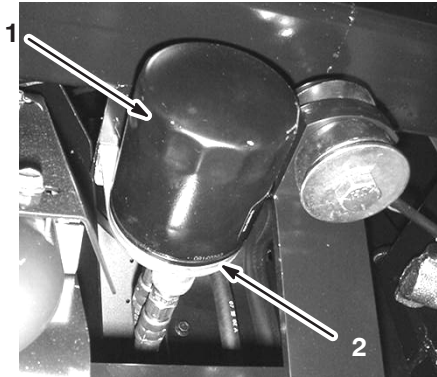

Figure 36

1. Oil filter
2. Filter adapter

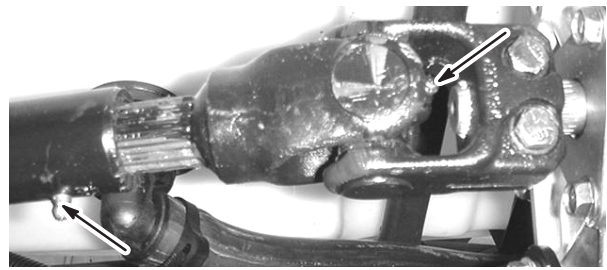

Figure 37

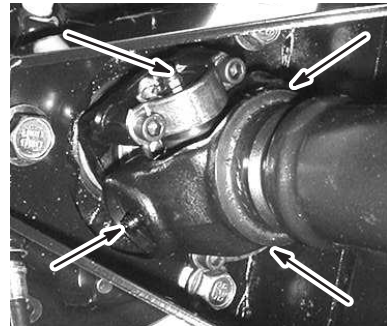

Figure 38

Four on each side

3. Wipe the filter adapter gasket surface (Fig. 36).
4. Apply a thin coat of new oil to the rubber gasket on the replacement filter (Fig. 36).
5. Install the replacement oil filter to the filter adapter. Turn the oil filter clockwise until the rubber gasket contacts the filter adapter, then tighten the filter an additional 1/2 turn (Fig. 36).
6. Fill the crankcase with the correct type of new oil; refer to Changing Oil, page 33, steps 8 through 10.
7. Dispose of the used oil filter at a certified recycling center.

Greasing the Sprayer

Lubricate all bearings and bushings after every 100 hours or once a year, whichever occurs first.

Grease Type: No. 2 General Purpose Lithium Base Grease

1. Wipe the grease fitting clean so that foreign matter cannot be forced into the bearing or bushing.
2. Pump grease into the bearing or bushing.
3. Wipe off excess grease.

The grease fitting locations are in the positions illustrated in Figures 37 through 43.

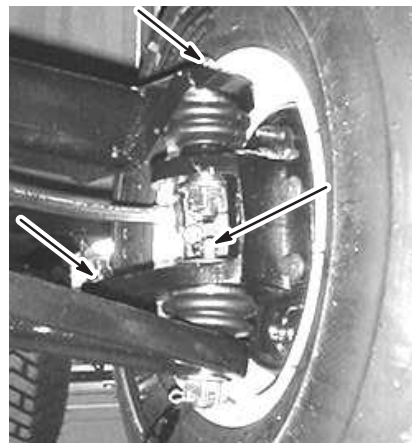

Figure 39

Three on each side

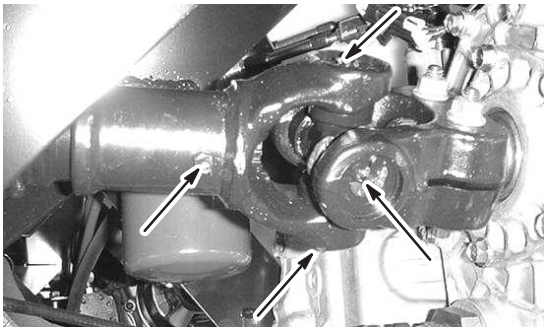

Figure 40
Five on each side

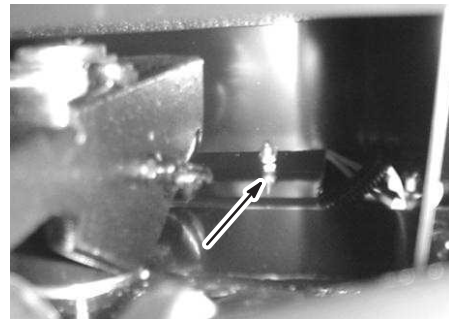

Figure 43

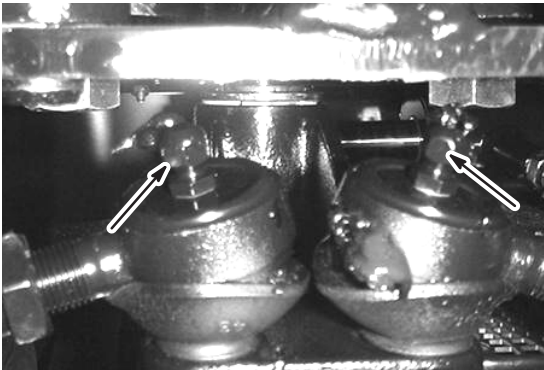

Figure 41

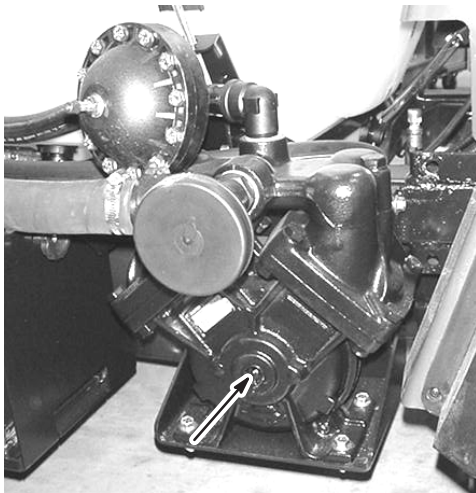

Figure 42

Greasing the Boom Pivot Arms

Grease Type: No. 2 general-purpose lithium base grease.

1. Manually place grease on the support shaft and within the ball seat of the hinge plate as shown in Figure 44.
2. Pump grease into the fitting located below the spring until grease can be seen coming out of the bottom of the pivot assembly (Fig.44).
3. Repeat the procedure for opposite pivot arm.

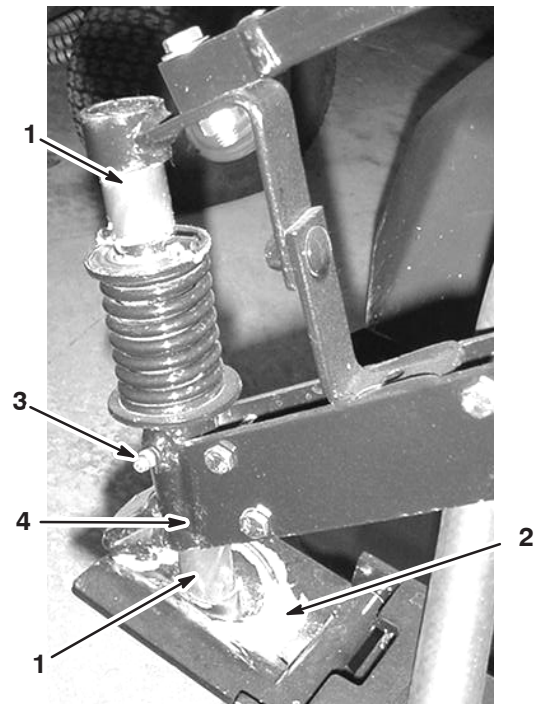

Figure 44

Left pivot arm shown

- | | |
|-----------------------------|-------------------|
| 1. Support shaft | 3. Grease fitting |
| 2. Ball seat of hinge plate | 4. Pivot assembly |

Replacing the Fuel Filter

Replace the fuel filter after every 100 operating hours.

1. Set the parking brake, stop the pump, stop the engine, and remove the ignition key.
2. Release the latch on the back of the seat and lift the seat forward.
3. Clamp off the hose on either side of the fuel filter to prevent gas from pouring out of the hoses when you remove the filter.
4. Place a drain pan under the filter.
5. Squeeze the ends of the hose clamps together and slide them away from the filter (Fig. 45).
6. Remove the filter from the fuel lines.

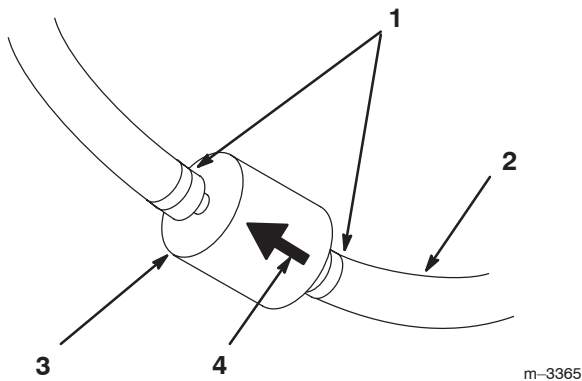

Figure 45

- | | |
|---------------|-------------------------|
| 1. Hose clamp | 3. Filter |
| 2. Fuel line | 4. Flow direction arrow |

7. Install a new filter and move the hose clamps close to the filter.

Ensure that the flow direction arrow points toward the engine.

Changing Transaxle/Hydraulic Fluid

Change Transaxle hydraulic fluid, filter and clean strainer every 800 hours.

1. Position the sprayer on a level surface, set the parking brake, stop the pump, stop the engine, and remove the ignition key.
2. Place a drain pan under the drain plug of the reservoir.
3. Remove the drain plug from the side of the reservoir and let the hydraulic fluid flow into the drain pan.

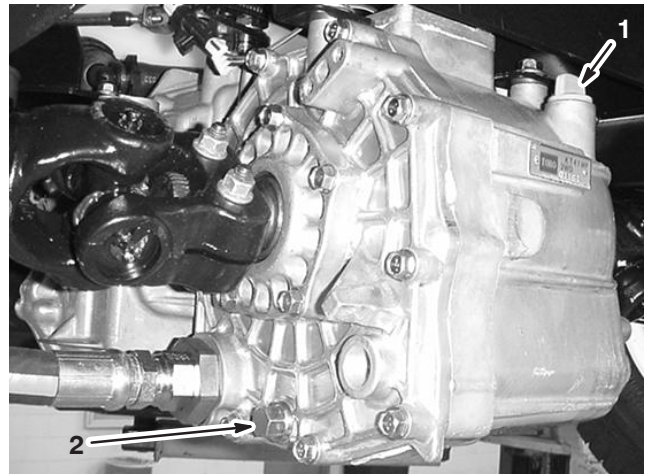

Figure 46

- | | |
|-----------------------|---------------|
| 1. Hydraulic dipstick | 2. Drain plug |
|-----------------------|---------------|

4. Note the orientation of the hydraulic hose and 90° fitting connected to the strainer.
5. Remove the hydraulic hose and 90° fitting.
6. Remove the strainer and clean it by back flushing it with a clean degreaser.

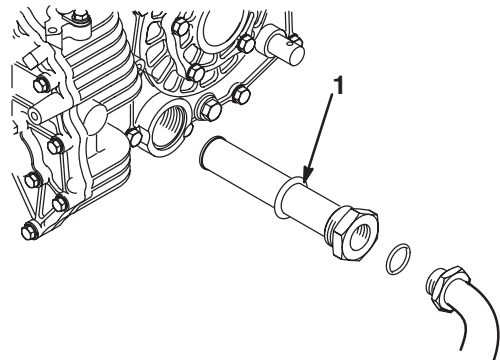

Figure 47

- | |
|-----------------------|
| 1. Hydraulic strainer |
|-----------------------|

7. Allow the strainer to air dry.
8. Install the strainer.
9. Install the hydraulic hose and 90° fitting to the strainer.
10. Install and tighten the drain plug.
11. Fill the reservoir with approximately 7.5 qt. of Dexron III ATF.

Important Use only the hydraulic fluids specified. Other fluids could cause system damage.

12. Start the engine and drive the sprayer to fill the hydraulic system. Recheck the oil level and replenish it, if required.

Replacing the Hydraulic Filter

Initially, replace the hydraulic filter after 8 operating hours, thereafter, replace filter every 800 hours.

Use the Toro replacement filter (Part No. 54-0110).

Important Use of any other filter may void the warranty on some components.

1. Position the sprayer on a level surface, set the parking brake, stop the pump, stop the engine, and remove the ignition key.
2. Clean the area around the filter mounting area.
3. Place a drain pan under the filter.
4. Remove the filter.
5. Lubricate the new filter gasket.



Figure 48

1. Hydraulic filter
2. Gasket

6. Ensure that the filter mounting area is clean.
7. Screw the filter on until the gasket contacts the mounting plate, then tighten the filter one-half turn.
8. Start the engine and let it run for about two minutes to purge air from the system. Stop the engine and check the hydraulic oil level and for leaks.

Changing the Pump Drive Gearbox Fluid

Change the pump drive gearbox after the first 50 hours and then after every 400 hours thereafter.

1. Position the sprayer on a level surface, set the parking brake, stop the pump, stop the engine, and remove the ignition key.

2. Place a pan under the drain plug on the pump drive gear box.

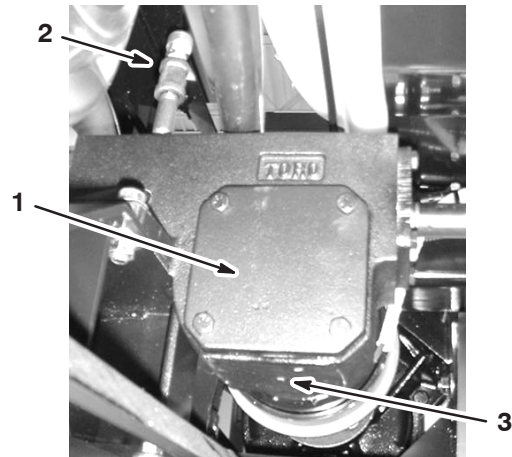

Figure 49

1. Pump drive gearbox
2. Fill tube
3. Drain plug

3. Remove the fill plug and drain plug (Fig.), allowing the oil to drain into the pan.
4. Install and tighten the drain plug when the fluid stops draining.
5. Add approximately 20 ounces (0.6 L) of Mobil SHC 634 Synthetic Lubricant to the fill tube.

Important Use only Mobil SHC 634 Synthetic Lubricant or equivalent synthetic fluid in the gear box. Non-synthetic oils may break down causing damage to the pump gearbox.

6. Install the fill plug.

Inspecting the Brakes

The brakes are a critical safety component of the sprayer. Inspect them as follows every 100 hours:

- Inspect the brake shoes for wear or damage. If the lining (brake pad) thickness is less than 1/16 inch (1.6 mm), replace the brake shoes.
- Inspect the backing plate and other components for signs of excessive wear or deformation. If any deformation is found, replace the appropriate components.

Adjusting the Parking Brake

Check the parking brake adjustment every 200 hours.

1. Loosen the set screw securing the knob to the parking brake lever.

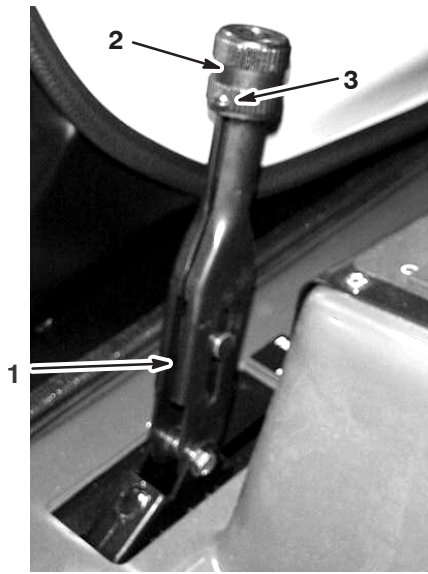

Figure 50

- | | |
|------------------------|--------------|
| 1. Parking brake lever | 3. Set screw |
| 2. Knob | |

2. Rotate the knob until a force of 35–45 lbs. is required to actuate lever.
3. Tighten the set screw.

Adjusting the Front Wheel Toe-In

Check the front wheel toe-in after every 100 operating hours, or annually, whichever occurs first. The toe-in should be 0 to 1/4 inch (0 to 6 mm).

1. Fill the tank with approximately 80 US gallons (303 L) of water.
2. Check and fill all tires; refer to Checking Tire Pressure, page 14.
3. Drive the sprayer back and forth a few times to relax the A-arms, then drive it forward at least 10 ft (3 m).
4. Measure the distance between both of the front tires at the axle height at both the front and rear of the front tires (Fig. 51). A fixture or alignment gauge is needed for the rear measurement of the front tires at axle height. Use the same fixture or alignment gauge to accurately measure the front of the front tires at axle height (Fig. 51).

The front of the tires should be 0 to 1/4 inch (0 to 6 mm) closer than the back side of the front tires.

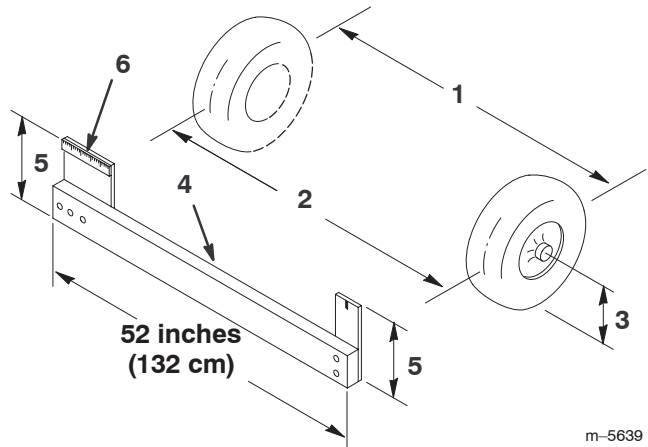

m-5639

Figure 51

- | | |
|---------------------------|------------------------------|
| 1. Tire center line—back | 4. Fixture |
| 2. Tire center line—front | 5. Axle center line distance |
| 3. Axle center line | 6. 6 inches (15 cm) ruler |

5. If the measurement does not fall within the specified range, loosen the jam nuts at both ends of the tie rods (Fig. 52).

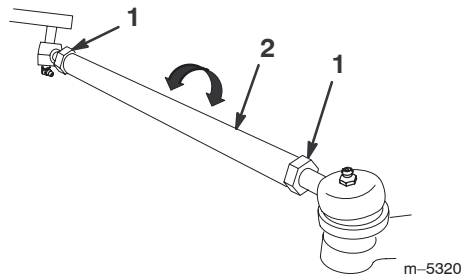

m-5320

Figure 52

- | | |
|------------|------------|
| 1. Jam nut | 2. Tie rod |
|------------|------------|

6. Rotate both tie rods to move the front of the tire inward or outward.

Note: The tie rods should be the same length when you are finished.

7. Tighten the tie rod jam nuts when the adjustment is correct.
8. Ensure that there is full travel of the steering wheel in both directions.

Servicing the Drive Belt

Checking the Drive Belt

Check the condition and tension of the drive belt after the first day of operation and every 200 operating hours thereafter.

1. Position the sprayer on a level surface, set the parking brake, move the range selector to the Neutral position, stop the pump, stop the engine, and remove the ignition key.
2. Rotate and inspect the drive belt for excessive wear or damage. Replace the belt if necessary.

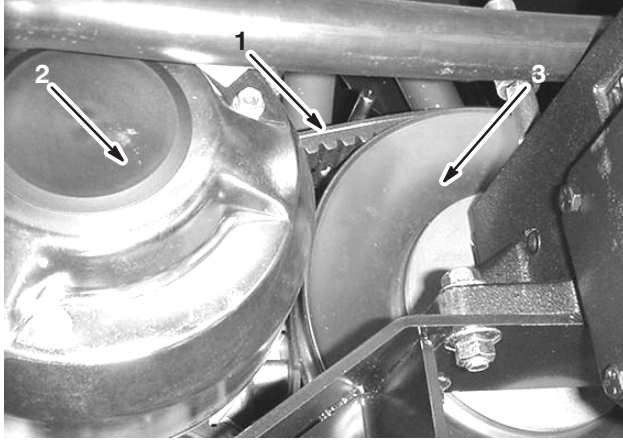

Figure 53

- | | |
|-------------------|---------------------|
| 1. Drive belt | 3. Secondary clutch |
| 2. Primary clutch | |

Replacing the Drive Belt

1. Rotate and route the belt over the secondary clutch (Fig. 53).
2. Remove the belt from the primary clutch (Fig. 53).
3. Place the new belt over the primary clutch (Fig. 53).
4. Rotate and install it over the secondary clutch (Fig. 53).

Adjusting the Steering Pump Belt

Check the tension of the steering pump belt after the first day of operation and every 100 operating hours thereafter. The belt should flex 1/4 inch (5 mm) when 5 lb of force (22 N) is applied midway on the top span.

1. Park the machine on a level surface, set the parking brake, turn the ignition off, and remove the key.

2. Loosen the steering pump mounting bolts (Fig. 54).

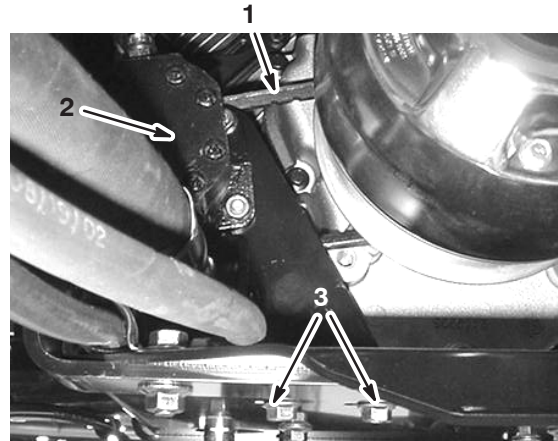

Figure 54

- | | |
|-----------------------|---------------------------------|
| 1. Steering pump belt | 3. Steering pump mounting bolts |
| 2. Steering pump | |

3. Move the pump until the belt flexes 1/4 inch (5 mm) with 5 lb. of force (22 N) then tighten the mounting bolts, starting with the bolt closest to the engine crankshaft.

Maintaining the Primary Drive Clutch

After every 400 operating hours or yearly, clean and lubricate the clutch as follows:

1. Stop the engine, remove the key, and set the parking brake.
2. Raise the front end of the sprayer and support it on jack stands.



Danger



A sprayer on a jack may be unstable and slip off of the jack, injuring anyone beneath it.

- Do not start the engine while the sprayer is on a jack.
- Always remove the key from the ignition before getting off of the sprayer.
- Block the tires when the sprayer is on a jack.

3. Disconnect the hose located on the lower-front face of the tank (Fig. 55).

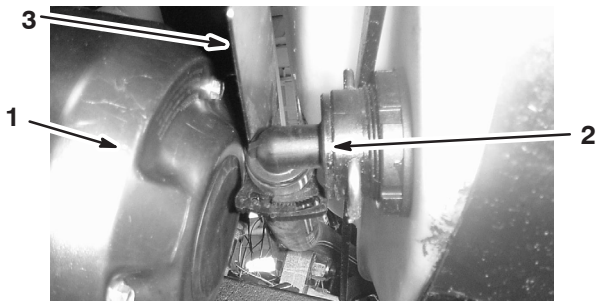

Figure 55

- 1. Clutch cover
- 2. Hose
- 3. Heat shield

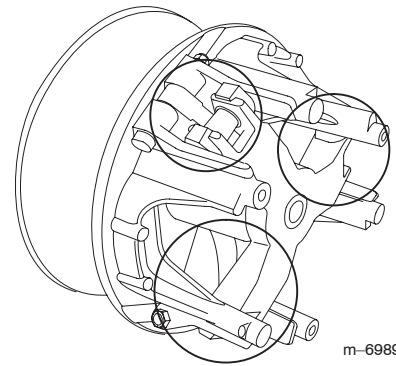

Figure 57

- 4. Remove the 3 bolts securing the cover to the clutch and remove the cover (Fig. 56).

Note: You may need to push the heat shield (Fig. 55) back as you remove the cover.

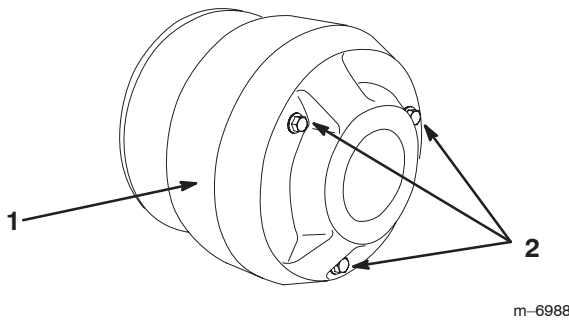

Figure 56

- 1. Cover
- 2. Bolts

Caution

The dust in the clutch will become airborne and could damage your eyes or you could inhale it causing breathing difficulties.

Wear safety goggles and a dust mask or other eye and respiratory protection when performing this procedure.

- 5. Lubricate the moving parts in the areas circled in Figure 57 using Toro Dry Lubricant Spray, available through your Authorized Toro Dealer or Distributor.

- 6. Install the clutch cover and secure it with the 3 bolts removed previously.

- 7. Connect the hose on the front of the tank (Fig. 55).

Changing the Spark Plugs

Change the spark plugs after every 200 operating hours. Make sure the air gap between the center and side electrodes is correct before installing the spark plugs. Use a spark plug wrench for removing and installing the spark plugs and a gapping tool/feeler gauge to check and adjust the air gap.

Type: Champion RC-12YC (or equivalent)
Air Gap: 0.030 inch (0.76 mm)

Removing the Spark Plug

- 1. Set the parking brake, stop the pump, stop the engine, and remove the ignition key.
- 2. Release the latch on the back of the seat and lift the seat forward.
- 3. Pull the wires off the spark plugs (Fig. 58).
- 4. Clean around the spark plugs to prevent dirt from falling into the engine and potentially causing damage.

- Remove the spark plugs and metal washers.

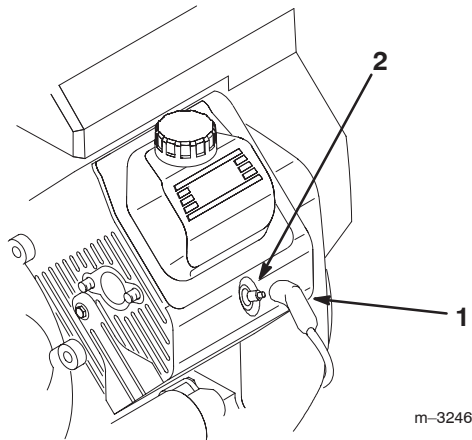

Figure 58

- Spark plug wire
- Spark plug

Checking the Spark Plugs

- Look at the center of the spark plugs (Fig. 59).

If you see a light brown or gray coating on the insulator, the engine is operating properly. A black coating on the insulator usually means the air cleaner is dirty.

Important Do not clean the spark plugs. Always replace a spark plug when it has a black coating, worn electrodes, an oily film, or cracks.

- Check the gap between the center and side electrodes (Fig. 59) and bend the side electrode, if the gap is not correct.

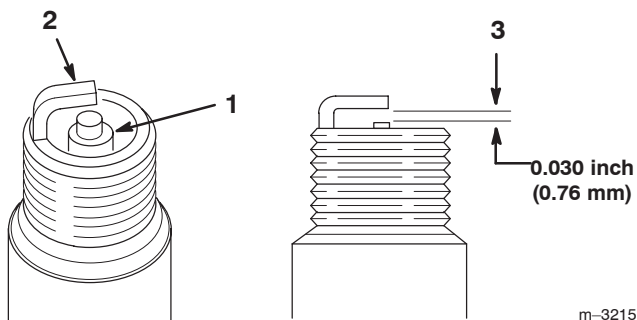

Figure 59

- Center electrode insulator
- Side electrode
- Air gap (not to scale)

Installing the Spark Plugs

- Install the spark plugs and metal washers.
- Tighten the spark plugs to 18 to 22 ft-lb (24.4 to 29.8 N·m).

- Push the wires onto the spark plugs (Fig. 58).
- Close and latch the seat.

Replacing the Fuses

There are 2 fuses and 2 empty slots in the electrical system. They are located beneath the seat (Fig. 60).

Main electrical system	30 amp
Spray system	10 amp
Open	20 amp
Open	30 amp

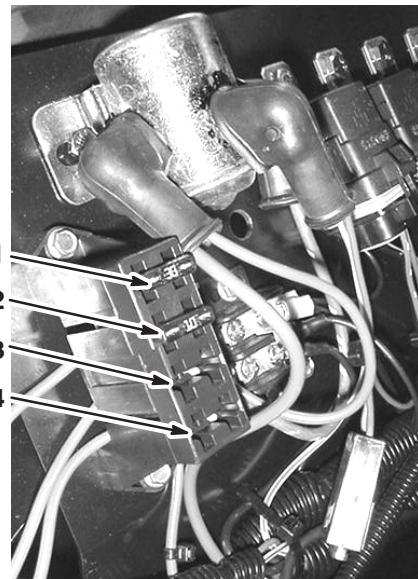

Figure 60

- Main electrical system
- Spray system
- Open 20 amp
- Open 30 amp

Servicing the Battery



Warning



CALIFORNIA

Proposition 65 Warning

Battery posts, terminals, and related accessories contain lead and lead compounds, chemicals known to the State of California to cause cancer and reproductive harm. Wash hands after handling.

Important Do not jump start the sprayer.

Always keep the battery clean and fully charged. Use a paper towel to clean the battery and battery box. If the battery terminals are corroded, clean them with a solution of four parts water and one part baking soda. Apply a light coating of grease to the battery terminals to prevent corrosion.

Voltage: 12 volt with 280 cold cranking Amps @ 0° F

Removing the Battery

1. Position the sprayer on a level surface, set the parking brake, stop the pump, stop the engine, and remove the ignition key.
2. Loosen the knobs on the sides of the battery box and remove the battery cover (Fig. 61).

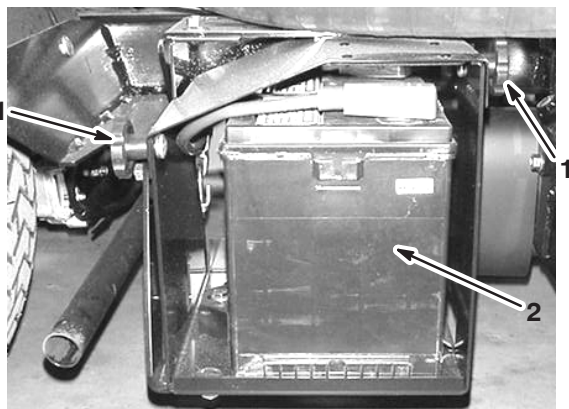

Figure 61

1. Knobs

2. Battery

3. Remove the battery retainer and fasteners (Fig. 61).
4. Disconnect the negative (black) ground cable from the battery post.



Warning



Incorrect battery cable routing could damage the sprayer and cables causing sparks. Sparks can cause the battery gasses to explode, resulting in personal injury.

- Always *disconnect* the negative (black) battery cable before disconnecting the positive (red) cable.
- Always *reconnect* the positive (red) battery cable before reconnecting the negative (black) cable.



Warning



Battery terminals or metal tools could short against metal sprayer components causing sparks. Sparks can cause the battery gasses to explode, resulting in personal injury.

- When removing or installing the battery, do not allow the battery terminals to touch any metal parts of the sprayer.
- Do not allow metal tools to short between the battery terminals and metal parts of the sprayer.
- Always keep the battery strap in place to protect and secure the battery.

5. Disconnect the positive (red) cable from the battery post.
6. Remove the battery.

Installing the Battery

1. Set the battery on the battery box so that the battery posts are toward the front of the sprayer.
2. Connect the positive (red) cable to the positive (+) battery post and the negative (black) cable to the negative (-) battery post using the bolts and wing nuts. Slide the rubber boot over the positive battery post.
3. Install the battery retainer and secure it with the fasteners you removed previously (Fig. 61).

Important

Always keep the battery retainer in place to protect and secure the battery.

4. Install the battery cover and secure it with the 2 knobs (Fig. 61).

Checking the Electrolyte Level

Check the electrolyte level every 50 operating hours or, if the machine is in storage, every 30 days.

1. Loosen the knobs on the sides of the battery box and remove the battery cover (Fig. 61).
2. Remove the filler caps. If the electrolyte is not up to the fill line, add the required amount of distilled water; refer to Adding Water to the Battery, page 43.



Danger



Battery electrolyte contains sulfuric acid which is a deadly poison and causes severe burns.

- **Do not drink electrolyte or allow it to contact your skin, eyes or clothing. Wear safety glasses to shield your eyes and rubber gloves to protect your hands.**
- **Fill the battery where clean water is always available for flushing the skin.**

Adding Water to the Battery

The best time to add distilled water to the battery is just before you operate the machine. This lets the water mix thoroughly with the electrolyte solution.

1. Clean the top of the battery with a paper towel.
2. Remove the filler caps from the battery and slowly fill each cell with distilled water until the level is up to the fill line. Replace the filler caps.

Important Do not overfill the battery. Electrolyte will overflow onto other parts of the sprayer and severe corrosion and deterioration will result.

Charging the Battery

Important Always keep the battery fully charged (1.260 specific gravity). This is especially important to prevent battery damage when the temperature is below 32° F (0° C).

1. Remove the battery from the chassis; refer to Removing the Battery, page 42.
2. Check the electrolyte level; refer to Checking the Electrolyte Level, page 42.
3. Connect a 3 to 4 amp battery charger to the battery posts. Charge the battery at a rate of 3 to 4 amperes for 4 to 8 hours (12 volts). Do not overcharge the battery.



Warning



Charging the battery produces gasses that can explode.

Never smoke near the battery and keep sparks and flames away from battery.

4. Install the battery in the chassis; refer to Installing the Battery, page 42.

Storing the Battery

If the machine will be stored for more than 30 days, remove the battery and charge it fully. Either store it on the shelf or on the machine. Leave the cables disconnected if it is stored on the machine. Store the battery in a cool atmosphere to avoid quick deterioration of the charge in the battery. To prevent the battery from freezing, make sure it is fully charged.

Cleaning the Suction Strainer

Clean the suction strainer daily. If you are using wettable powders, clean it after every tank.

1. Remove the retainer from the red fitting attached to the large hose on the top of the tank.

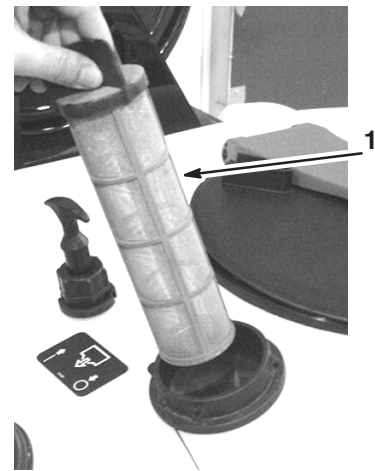

Figure 62

1. Suction strainer

2. Disconnect the hose from the tank.
3. Pull the strainer out of the hole.
4. Clean the strainer with clean running water.
5. Replace the strainer, seating it fully into the hole.
6. Connect the hose to the top of the tank and secure it with the retainer.

Note: Other screen meshes are available. Contact your Authorized Toro Dealer.

Cleaning the Flowmeter

Occasionally, the flowmeter may need to be cleaned to remove an obstruction, as follows:

1. Disconnect the flowmeter wire from wiring harness.

- Remove the retaining cap from the flowmeter body (Fig. 63).

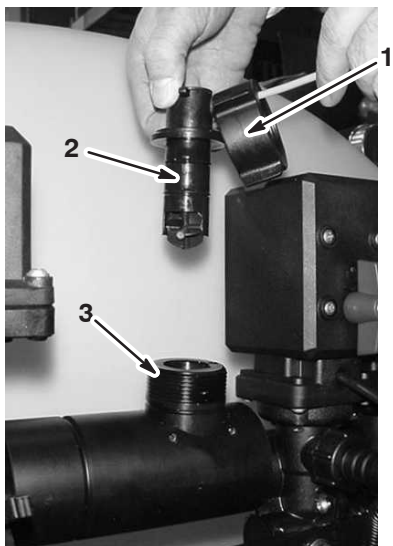

Figure 63

- Retaining cap
- Paddle wheel assembly
- Flowmeter body

- Carefully pull the paddle wheel assembly from the body.
- Use warm water, a soft-bristled brush, and a mild detergent as necessary to clean the flowmeter body and paddle wheel. Remove any small metallic debris.

Important Do not use solvents or fuel to clean the flowmeter.

- Install the paddle wheel assembly into the flowmeter body.

Important The paddle wheel assembly will only fit into the body one way, in a detent slot on the side of the body. Do not force the paddle wheel assembly into the body in any other orientation.

- Install the retaining cap.
- Connect the wire to the flowmeter.

Stowing the Boom Extensions

Use the boom restraints to lock the boom extensions in the X position when you are not spraying.

- Pivot the left boom extension into the upright position.

Important Do not force the boom extension past the restraint hook when stowing or you may damage the extension and nozzles.

- Push up on the right restraint knob to compress the spring and extend the hook.

- With the spring compressed, rotate the hook to catch the boom extension frame.
- Release the knob allowing the hook to catch the boom extension frame and secure it to the boom holder.
- Repeat steps 1 through 4 with the right boom extension and left boom holder.

Adjusting the Extension Booms

The electric lift on each extension boom adjusts the boom position. To ensure trouble-free operation, you must not allow the extension boom structure to contact any other portion of the boom structure during operation.

You must allow the actuator to travel its full stroke and be stopped by its own internal limits.

When the boom is fully upright, ensure that the ball support structure on the boom does not contact the center boom cut out. There should be a gap equal to the thickness of a 12-gauge piece of steel (0.106 inch or 3 mm) between these two components (Fig. 64).

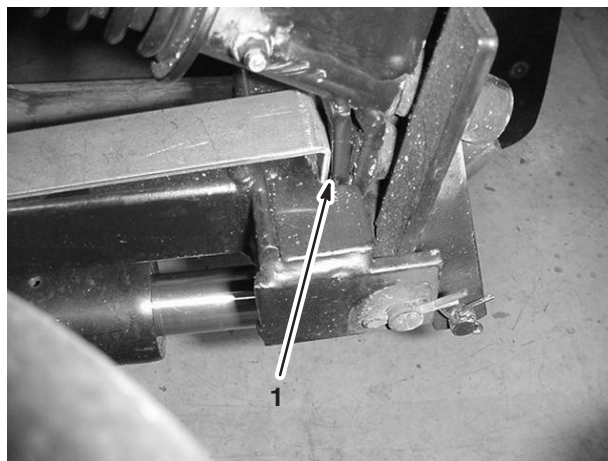

Figure 64

- 12-gauge steel shim

To ensure this gap, adjust the boom as follows:

- Set the boom in the horizontal position.
- Rotate the adjustment nut until it is as close to the clevis as possible.
- Snug the clevis into position by tightening the jam nut.
- Engage the electric lift to raise the boom to the fully upright position.

Note: The actuator must be fully extended at this point (at the end of its travel, a clutch will disengage and you will hear clicking if the power is held on to the actuator).

5. Insert a strip of 12-gauge steel stock between the ball support and the cutout on the center boom.
6. Loosen the jam nut and rotate the adjustment nut to bring the ball support into contact with the 12-gauge sheet stock shim and the cutout on the center boom.
7. Tighten the jam nut.
8. Remove the sheet stock shim.
9. Move the boom throughout its length of travel.

Note: Ensure that no part of the boom assembly contacts any objects that may impede the boom travel.

Note: When you complete the adjustment, ensure that the axis of the clevis pin is horizontal.

Note: The extension boom nozzles must be spaced 20 inches apart. Verify this spacing and adjust the nozzles if necessary.

Storage

1. Position the sprayer on a level surface, set the parking brake, stop the pump, stop the engine, and remove the ignition key.
2. Clean dirt and grime from the entire machine, including the outside of the engine's cylinder head fins and blower housing.

Important You can wash the machine with mild detergent and water. **Do not use high pressure water** to wash the machine. Pressure washing may damage the electrical system or wash away necessary grease at friction points. Avoid excessive use of water, especially near the control panel, lights, engine, and the battery.

3. Clean the spray system; refer to Cleaning the Sprayer, page 27.
4. Add a rust inhibiting, non-alcohol based, RV antifreeze solution to the system and run the pump for a few minutes to circulate it through the system, then drain the spray system as completely as possible.
5. Inspect the brakes; refer to Inspecting the Brakes, page 37.
6. Service the air cleaner; refer to Servicing the Air Cleaner, page 31.
7. Grease the sprayer; refer to Greasing the Sprayer, page 34.
8. Change the crankcase oil; refer to Servicing Engine Oil, page 33.
9. Check the tire pressure; refer to Checking the Tire Pressure, page 14.
10. For storage over 30 days, prepare the fuel system as follows:
 - A. Add a petroleum based stabilizer/conditioner to fuel in the tank.

Follow mixing instructions from stabilizer manufacturer. (1 oz. per gallon). **Do not use an alcohol based stabilizer (ethanol or methanol).**

Note: A fuel stabilizer/conditioner is most effective when mixed with fresh gasoline and used at all times.
 - B. Run the engine to distribute conditioned fuel through the fuel system (5 minutes).
 - C. Stop the engine, allow it to cool, and drain the fuel tank.
 - D. Restart the engine and run it until it stops.
 - E. Choke the engine.
 - F. Start and run the engine until it will not start again.
 - G. Dispose of fuel properly. Recycle as per local codes.

Important Do not store stabilizer/conditioned gasoline over 90 days.

11. Remove the spark plugs and check their condition; refer to Changing Spark Plugs, page 40.
12. With the spark plugs removed from the engine, pour two tablespoons of engine oil into the spark plug hole.
13. Use the electric starter to crank the engine and distribute the oil inside the cylinder.
14. Install the spark plugs and tighten to recommended torque; refer to Changing Spark Plugs, page 40.

Note: Do not install the wire on the spark plug(s).

15. Remove the battery from the chassis, check the electrolyte level, and charge it fully; refer to Servicing the Battery, page 41.

Note: Do not connect the battery cables to the battery posts during storage.

Important The battery must be fully charged to prevent it from freezing and being damaged at temperatures below 32°F (0°C). A fully charged battery maintains its charge for about 50 days at temperatures lower than 40°F (4°C). If the temperatures will be above 40°F (4°C), check the water level in the battery and charge it every 30 days.

16. Check and tighten all bolts, nuts, and screws. Repair or replace any part that is damaged.
17. Check the condition of all spray hoses, replacing any that are damaged or worn.
18. Tighten all hose fittings.
19. Paint all scratched or bare metal surfaces.

Paint is available from your Authorized Service Dealer.

20. Store the machine in a clean, dry garage or storage area.
21. Remove the ignition key and put it in a safe place out of the reach of children.
22. Cover the machine to protect it and keep it clean.

Troubleshooting

Troubleshooting the Engine and Vehicle

Problem	Possible Causes	Corrective Action
The starter does not crank.	<ol style="list-style-type: none"> 1. The range selector is in a gear other than Neutral. 2. The electrical connections are corroded or loose. 3. A fuse is blown or loose. 4. The battery is discharged. 5. The safety interlock system is malfunctioning. 6. A broken starter or starter solenoid. 7. Seized internal engine components. 	<ol style="list-style-type: none"> 1. Press the brake pedal and move the range selector to the Neutral position. 2. Check the electrical connections for good contact. 3. Correct or replace fuse. 4. Charge or replace the battery. 5. Contact your Authorized Service Dealer. 6. Contact your Authorized Service Dealer. 7. Contact your Authorized Service Dealer.

Problem	Possible Causes	Corrective Action
The engine cranks, but will not start.	<ol style="list-style-type: none"> 1. The fuel tank is empty. 2. Dirt, water, or stale fuel is in the fuel system. 3. Clogged fuel line. 4. The spark plug lead is disconnected. 5. A spark plug is damaged or dirty. 6. The kill relay is not energized. 7. The ignition is broken. 	<ol style="list-style-type: none"> 1. Fill with fresh fuel. 2. Drain and flush the fuel system; add fresh fuel. 3. Clean or replace. 4. Reconnect the spark plug. 5. Replace the spark plug. 6. Contact your Authorized Service Dealer. 7. Contact your Authorized Service Dealer.
The engine starts, but does not keep running	<ol style="list-style-type: none"> 1. The fuel tank vent is restricted. 2. Dirt or water in the fuel system. 3. The fuel filter is clogged. 4. A fuse is blown or loose. 5. The fuel pump is broken. 6. The carburetor is broken. 7. Loose wires or poor connections. 8. The cylinder head gasket is broken. 	<ol style="list-style-type: none"> 8. Replace the fuel cap. 9. Drain and flush the fuel system; add fresh fuel. 10. Replace the fuel filter. 11. Correct or replace fuse. 12. Contact your Authorized Service Dealer. 13. Contact your Authorized Service Dealer. 14. Check and tighten wire connections. 15. Contact your Authorized Service Dealer.
The engine runs, but knocks or misses.	<ol style="list-style-type: none"> 1. Dirt, water, or stale fuel is in the fuel system. 2. A spark plug lead is loose. 3. A spark plug is broken. 4. Loose wires or poor connections. 5. Engine overheating. 	<ol style="list-style-type: none"> 1. Drain and flush the fuel system; add fresh fuel. 2. Reconnect the spark plug lead. 3. Replace the spark plug. 4. Check and tighten wire connections. 5. See Engine Overheats.

Problem	Possible Causes	Corrective Action
The engine will not idle.	<ol style="list-style-type: none"> 1. The fuel tank vent is restricted. 2. Dirt, water, or stale fuel is in the fuel system. 3. A spark plug is damaged or broken. 4. Carburetor idle passages are plugged. 5. The idle speed adjusting screw is incorrectly set. 6. The fuel pump is broken. 7. Low compression. 8. The air cleaner element is dirty. 	<ol style="list-style-type: none"> 1. Replace the fuel cap. 2. Drain and flush the fuel system; add fresh fuel. 3. Replace the spark plug. 4. Contact your Authorized Service Dealer. 5. Contact your Authorized Service Dealer. 6. Contact your Authorized Service Dealer. 7. Contact your Authorized Service Dealer. 8. Clean or replace.
The engine overheats.	<ol style="list-style-type: none"> 1. The crankcase oil level is incorrect. 2. Excessive loading. 3. The air intake screens are dirty. 4. The cooling fins and air passages under the engine blower housing and/or the rotating air intake screen are plugged. 5. The fuel mixture is lean. 	<ol style="list-style-type: none"> 1. Fill or drain to the full mark. 2. Reduce load; use lower ground speed. 3. Clean with every use. 4. Clean with every use. 5. Contact your Authorized Service Dealer.
The engine loses power.	<ol style="list-style-type: none"> 1. The crankcase oil level is incorrect. 2. The air cleaner element is dirty. 3. Dirt, water, or stale fuel is in the fuel system. 4. The engine is overheated. 5. A spark plug is damaged or dirty. 6. The vent hole in the fuel tank vent fitting is plugged. 7. Low compression. 	<ol style="list-style-type: none"> 1. Fill or drain to the full mark. 2. Clean or replace. 3. Drain and flush the fuel system; add fresh fuel. 4. See Engine Overheats. 5. Replace the spark plug. 6. Replace the fuel cap. 7. Contact your Authorized Service Dealer.
The sprayer will not operate or is sluggish in either direction because the engine bogs down or stalls.	<ol style="list-style-type: none"> 1. The parking brake is set. 	<ol style="list-style-type: none"> 1. Release the parking brake

Problem	Possible Causes	Corrective Action
The sprayer will not operate in either direction.	<ol style="list-style-type: none"> 1. The range selector is in the Neutral position. 2. The parking brake was not released or the parking brake is not releasing. 3. The transmission is broken. 4. The control linkage needs adjustment or replacement. 5. The drive shaft or wheel hub key has been damaged. 	<ol style="list-style-type: none"> 1. Press the brake and shift the range selector into a gear. 2. Release the parking brake or check the linkage. 3. Contact your Authorized Service Dealer. 4. Contact your Authorized Service Dealer. 5. Contact your Authorized Service Dealer.
Abnormal vibration or noise.	<ol style="list-style-type: none"> 1. The engine mounting bolts are loose. 2. There is a problem with the 	<ol style="list-style-type: none"> 1. Tighten the engine mounting bolts. 2. Contact your Authorized Service Dealer.

Troubleshooting the Spray System

Problem	Possible Causes	Corrective Action
A boom section does not spray.	<ol style="list-style-type: none"> 1. The electrical connection on the boom valve is dirty or disconnected 2. Blown fuse 3. Pinched hose 4. A boom by-pass valve is improperly adjusted. 5. Damaged boom valve 6. Damaged electrical system 	<ol style="list-style-type: none"> 1. Turn the valve off manually. Disconnect the electrical connector on the valve and clean all leads, then reconnect it. 2. Check the fuses and replace them as necessary. 3. Repair or replace the hose. 4. Adjust the boom by-pass valves. 5. Contact your Authorized Service Dealer. 6. Contact your Authorized Service Dealer.
A boom section does not turn off.	<ol style="list-style-type: none"> 1. The valve is damaged. 	<ol style="list-style-type: none"> 1. Stop the spray system and pump and turn off the sprayer. Remove the retainer from under the boom valve and pull out the motor and stem. Inspect all parts and replace any that appear damaged.
A boom valve is leaking	<ol style="list-style-type: none"> 1. An O-ring is deteriorated. 	<ol style="list-style-type: none"> 1. Stop the spray system and pump and turn off the sprayer. Disassemble the valve and replace the O-rings.

Problem	Possible Causes	Corrective Action
A pressure drop occurs when you turn on a boom.	<ol style="list-style-type: none"> 1. The boom bypass valve is improperly adjusted. 2. There is an obstruction in the boom valve body. 3. A nozzle filter is clogged. 	<ol style="list-style-type: none"> 1. Adjust the boom bypass valve. 2. Remove the inlet and outlet connections to the boom valve and remove any obstructions. 3. Remove and clean all nozzles.

Troubleshooting the Spray Pro Monitor

Problem	Possible Causes	Corrective Action
The monitor does not function.	<ol style="list-style-type: none"> 1. The monitor cable is loose or disconnected. 2. The monitor or cable is damaged. 	<ol style="list-style-type: none"> 1. Connect the monitor cable. 2. Contact your Authorized Service Dealer.
The Speed is always 0 or is erratic.	<ol style="list-style-type: none"> 1. The monitor cable is loose. 2. The speed sensor is not calibrated correctly. 3. The speed sensor is damaged. 	<ol style="list-style-type: none"> 1. Connect the monitor cable. 2. Calibrate the speed sensor. 3. Contact your Authorized Service Dealer.
The Area is inaccurate.	<ol style="list-style-type: none"> 1. The sprayer width is not correctly entered. 2. The speed sensor is not calibrated correctly. 3. The speed sensor is damaged. 	<ol style="list-style-type: none"> 1. Check and set the appropriate Width in the calibration mode. 2. Calibrate the speed sensor. 3. Contact your Authorized Service Dealer.
The Distance is inaccurate.	<ol style="list-style-type: none"> 1. The speed sensor is not calibrated correctly. 2. The speed sensor is damaged. 	<ol style="list-style-type: none"> 1. Calibrate the speed sensor. 2. Contact your Authorized Service Dealer.
The monitor does not display Application Rate or Total Volume.	<ol style="list-style-type: none"> 1. The monitor cable is loose. 2. The flow meter is dirty or clogged. 3. The flow meter is not calibrated correctly. 4. The flow meter is damaged. 	<ol style="list-style-type: none"> 1. Connect the monitor cable. 2. Clean the flow meter. 3. Calibrate the flowmeter 4. Contact your Authorized Service Dealer.
The Total Volume is inaccurate.	<ol style="list-style-type: none"> 1. The flow meter is dirty or clogged. 2. The flow meter is not calibrated correctly. 3. The flow meter is damaged. 	<ol style="list-style-type: none"> 1. Clean the flow meter. 2. Calibrate the flowmeter 3. Contact your Authorized Service Dealer.
The monitor displays 6553.5 when in the Application Rate setting.	<ol style="list-style-type: none"> 1. The monitor is not receiving data from the speed sensor. 	<ol style="list-style-type: none"> 1. Contact your Authorized Service Dealer.

Problem	Possible Causes	Corrective Action
The monitor is erratic in operation.	1. A two-way radio is too close to the monitor or its cables.	1. Keep two-way radios away from the monitor and its cables.
The displayed measurements do not make sense.	1. The Units of Measurement is set to a system other than what you expect.	1. Check the Units of Measurement to ensure that it is set correctly.
The monitor reads "OFL."	1. The data has exceeded the maximum allowed.	1. Press and hold the [Reset] button to clear the monitor.



The Toro General Commercial Products Warranty

A Two-Year Limited Warranty

Conditions and Products Covered

The Toro Company and its affiliate, Toro Warranty Company, pursuant to an agreement between them, jointly warrant your Toro Commercial Product ("Product") to be free from defects in materials or workmanship for two years or 1500 operational hours*, whichever occurs first. Where a warrantable condition exists, we will repair the Product at no cost to you including diagnosis, labor, parts, and transportation. This warranty begins on the date the Product is delivered to the original retail purchaser.

* Product equipped with hour meter

Instructions for Obtaining Warranty Service

You are responsible for notifying the Commercial Products Distributor or Authorized Commercial Products Dealer from whom you purchased the Product as soon as you believe a warrantable condition exists.

If you need help locating a Commercial Products Distributor or Authorized Dealer, or if you have questions regarding your warranty rights or responsibilities, you may contact us at:

Toro Commercial Products Service Department
Toro Warranty Company
8111 Lyndale Avenue South
Bloomington, MN 55420-1196
952-888-8801 or 800-982-2740
E-mail: commercial.service@toro.com

Owner Responsibilities

As the Product owner, you are responsible for required maintenance and adjustments stated in your operator's manual. Failure to perform required maintenance and adjustments can be grounds for disallowing a warranty claim.

Items and Conditions Not Covered

Not all product failures or malfunctions that occur during the warranty period are defects in materials or workmanship. This express warranty does not cover the following:

- Product failures which result from the use of non-Toro replacement parts, or from installation and use of add-on, modified, or unapproved accessories
- Product failures which result from failure to perform required maintenance and/or adjustments
- Product failures which result from operating the Product in an abusive, negligent or reckless manner
- Parts subject to consumption through use unless found to be defective. Examples of parts which are consumed, or used up, during normal Product operation include, but are not limited to, blades, reels, bedknives, tines, spark plugs, castor wheels, tires, filters, belts, and certain sprayer components such as diaphragms, nozzles, and check valves, etc.

Countries Other than the United States or Canada

Customers who have purchased Toro products exported from the United States or Canada should contact their Toro Distributor (Dealer) to obtain guarantee policies for your country, province, or state. If for any reason you are dissatisfied with your Distributor's service or have difficulty obtaining guarantee information, contact the Toro importer. If all other remedies fail, you may contact us at Toro Warranty Company.

- Failures caused by outside influence. Items considered to be outside influence include, but are not limited to, weather, storage practices, contamination, use of unapproved coolants, lubricants, additives, or chemicals, etc.
- Normal "wear and tear" items. Normal "wear and tear" includes, but is not limited to, damage to seats due to wear or abrasion, worn painted surfaces, scratched decals or windows, etc.

Parts

Parts scheduled for replacement as required maintenance are warranted for the period of time up to the scheduled replacement time for that part.

Parts replaced under this warranty become the property of Toro. Toro will make the final decision whether to repair any existing part or assembly or replace it. Toro may use factory remanufactured parts rather than new parts for some warranty repairs.

General Conditions

Repair by an Authorized Toro Distributor or Dealer is your sole remedy under this warranty.

Neither The Toro Company nor Toro Warranty Company is liable for indirect, incidental or consequential damages in connection with the use of the Toro Products covered by this warranty, including any cost or expense of providing substitute equipment or service during reasonable periods of malfunction or non-use pending completion of repairs under this warranty. Except for the Emissions warranty referenced below, if applicable, there is no other express warranty. All implied warranties of merchantability and fitness for use are limited to the duration of this express warranty.

Some states do not allow exclusions of incidental or consequential damages, or limitations on how long an implied warranty lasts, so the above exclusions and limitations may not apply to you.

This warranty gives you specific legal rights, and you may also have other rights which vary from state to state.

Note regarding engine warranty: The Emissions Control System on your Product may be covered by a separate warranty meeting requirements established by the U.S. Environmental Protection Agency (EPA) and/or the California Air Resources Board (CARB). The hour limitations set forth above do not apply to the Emissions Control System Warranty. Refer to the Engine Emission Control Warranty Statement printed in your operator's manual or contained in the engine manufacturer's documentation for details.