

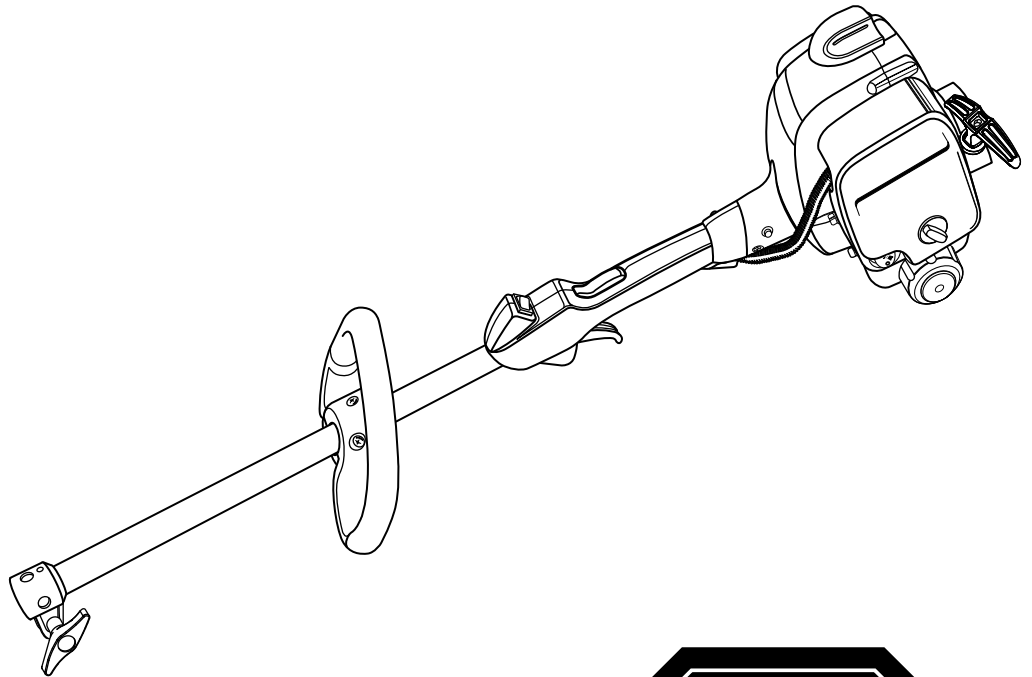







Count on it.

Operator's Manual

25.4 cc Gas Power Head
Model No. 51947—313000001 & Up



NOTICE

    

Do not use E15, E20, or E85 fuel (or fuel containing greater than 10% ethanol) in this product. It is a violation of federal law and will damage the unit and void your warranty.

STOP

If you have questions concerning your trimmer, please call us at 1-866-574-9242 (US) or 1-866-574-9243 (Canada).

WARNING:
To reduce the risk of injury, the user must read and understand the operator's manual. Save this manual.

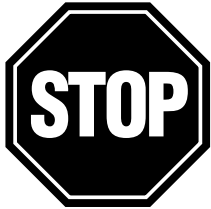

READ THIS INFORMATION

Before you use your new trimmer, read the following helpful hints to get you started.

Fueling

WARNING:

Gasoline and its vapors are highly flammable and explosive. To prevent serious personal injury and property damage, handle it with care. Keep away from ignition sources and open flames, handle outdoors only, do not smoke and wipe up spills immediately.

1. Obtain a clean container that is approved for use with gasoline.
2. Mix all of the 2-cycle oil provided with 1 US gallon of 87-octane, unleaded gasoline (50:1).
3. Fill the trimmer's gas tank carefully.

Cold Starting vs. Warm Starting

When you restart the trimmer and you are not sure whether the engine is still warm, set the choke lever to **RUN** and pull the starter cord. If the engine does not start within 5 pulls, refer to "To Start a Cold Engine" later in this manual.

Flooded Engine

Will the engine start? If not, it may be flooded. Relax, this is easy to correct. Set the choke lever to **RUN**. Squeeze the trigger and pull the starter cord quickly for 10 to 12 pulls.

If the engine does not start, refer to "Troubleshooting" later in this manual or call toll-free at 1-866-574-9242 (US) or 1-866-574-9243 (Canada).



For questions concerning your trimmers, call us toll free at 1-866-574-9242 (US) or 1-866-574-9243 (Canada).

California Proposition 65

 WARNING: This product, its exhaust, and other substances that may become airborne from its use may contain chemicals, including lead, known to the State of California to cause cancer, birth defects, or other reproductive harm. *Wash hands after handling.*

Table of Contents

Introduction.....	4
General Safety Rules.....	5-6
Specific Safety Rules	6
Symbols.....	7
Product Labels	8
Features	9
Product Specifications	9
Assembly.....	10-11
Unpacking.....	10
Packing List	10
Connecting the Attachment to the Upper Shaft	10
Removing the Attachment from the Upper Shaft	11
Attaching the Front Handle	11
Operation.....	12-14
Applications.....	12
Fueling and Refueling the Power Head.....	12
Oxygenated Fuels	12
Operating the Power Head.....	13
Blade Thrust	13
Starting the Product	14
Stopping the Product.....	14
Maintenance	15-18
General Maintenance.....	15
Cleaning the Product.....	15
Servicing the Product.....	15
Checking the Fuel Cap, Tank, and Lines	15
Cleaning the Air Filter	15
Replacing the Spark Arrestor.....	16
Replacing the Spark Plug.....	16
Idle Speed Adjustment.....	17
Storing the Product	17
Transporting the Product	17
High Altitude Engine Operation	18
Maintenance Schedule	18
Troubleshooting	19
Warranty.....	20

Introduction

Thank you for purchasing a Toro product.

We would like for you to be completely satisfied with your new product, so feel free to contact an authorized service dealer for help with service, genuine Toro parts, or other information you may require.

Whenever you contact an authorized service dealer, always know the model and serial numbers of the product. These numbers will help the service representative provide exact information about your specific product. You will find the model and serial number decal located on the motor housing.

For your convenience, write the product model and serial numbers in the space below.

Model No.	
Serial No.	

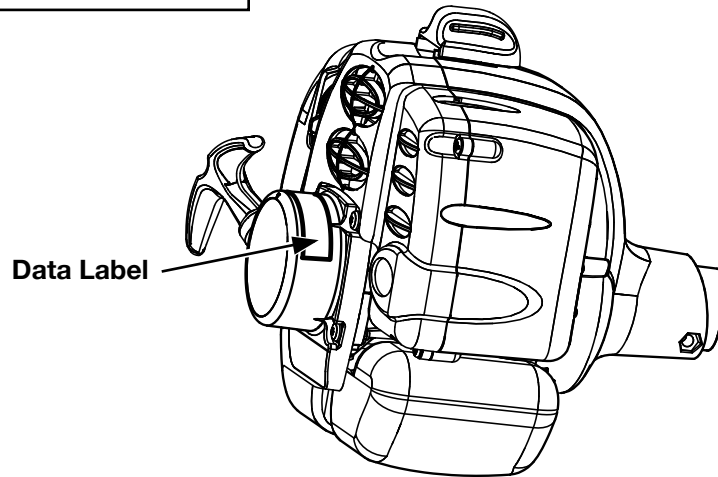

Read this manual carefully to learn how to operate and maintain your product correctly. Reading this manual will help you and others avoid personal injury and damage to the product. Although Toro designs, produces, and markets safe, state-of-the-art products, you are responsible for using the product properly and safely. You are also responsible for training persons you allow to use the product about safe operation.

The Toro warning system in this manual identifies potential hazards and has special safety messages that help you and others avoid personal injury, even death. DANGER, WARNING, and CAUTION are signal words that identify the level of hazard. However, regardless of the hazard, be extremely careful. Two other words, "Important" and "Note," highlight information.

General Safety Rules

WARNING:

Read and understand all instructions. Failure to follow all instructions may result in electric shock, fire and/or serious personal injury.

Read All Instructions

- For safe operation, read and understand all instructions before using this product. Follow all safety instructions. Failure to follow all safety instructions listed below, can result in serious personal injury.
 - Do not allow children or untrained individuals to use this unit.
 - Do not start or operate the engine in a confined space, building, near open windows, or in other unventilated space where dangerous carbon monoxide fumes can collect. Carbon monoxide, a colorless, odorless, and extremely dangerous gas, can cause unconsciousness or death.
 - Clear the work area before each use. Remove all objects such as rocks, broken glass, nails, wire, or loose string which can be thrown or become entangled in the cutting line or blade.
 - Always wear eye protection with side shields marked to comply with ANSI Z87.1 along with hearing protection when operating this equipment.
 - Wear heavy, long pants, long sleeves, boots, and gloves. Do not wear loose fitting clothing, short pants, sandals, or go barefoot. Do not wear jewelry of any kind.
 - Heavy protective clothing may increase operator fatigue, which could lead to heat stroke. During weather that is hot and humid, heavy work should be scheduled for early morning or late afternoon hours when temperatures are cooler.
 - Product users on United States Forest Service land, and in some states, must comply with fire prevention regulations. This product is equipped with a spark arrestor; however, other user requirements may apply. Check with your federal, state, or local authorities.
 - Never operate this unit on the operator's left side.
 - Secure long hair above shoulder level to prevent entanglement in moving parts.
 - Keep all bystanders, children, and pets at least 50 ft. (15 m) away. Bystanders should be encouraged to wear eye protection. If you are approached, stop the engine and cutting attachment. In the case of bladed units, there is the added risk of injury to bystanders from being struck with the moving blade in the event of a blade thrust or other unexpected reaction of the saw.
 - Do not operate this unit when you are tired, ill, upset, or under the influence of alcohol, drugs, or medication.
 - Do not operate in poor lighting.
 - Keep firm footing and balance. Do not overreach. Overreaching can result in loss of balance or exposure to hot surfaces.
 - Do not use on a ladder or unstable support. Stable footing on a solid surface enables better control of the unit in unexpected situations.
 - Keep all parts of your body away from any moving part.
 - To avoid hot surfaces, never operate the unit with the bottom of the engine above waist level.
 - Do not touch area around the muffler or cylinder of the unit, these parts get hot from operation. Contact with hot surfaces could result in possible serious personal injury.
 - Always stop the engine and remove the spark plug wire before making any adjustments or repairs except for carburetor adjustments.
 - Inspect the unit before each use for loose fasteners, fuel leaks, etc. Replace any damaged parts before use.
 - Never use blades, flailing devices, wire, or rope on trimmer attachment. Never use flailing devices, wire, or rope on any attachment.
 - The cutting attachment should never rotate at idle during normal use. The cutting attachment may rotate at idle during carburetor adjustments.
 - It has been reported that vibrations from hand-held tools may contribute to a condition called Raynaud's Syndrome in certain individuals. Symptoms may include tingling, numbness, and blanching of the fingers, usually apparent upon exposure to cold. Hereditary factors, exposure to cold and dampness, diet, smoking, and work practices are all thought to contribute to the development of these symptoms. It is presently unknown what, if any, vibrations or extent of exposure may contribute to the condition. There are measures that can be taken by the operator to possibly reduce the effects of vibration:
 - a) Keep your body warm in cold weather. When operating the unit wear gloves to keep hands and wrists warm. It is reported that cold weather is a major factor contributing to Raynaud's Syndrome.
 - b) After each period of operation, exercise to increase blood circulation.
 - c) Take frequent work breaks. Limit the amount of exposure per day.
 - d) Keep the tool well maintained, fasteners tightened, and worn parts replaced.
- If you experience any of the symptoms of this condition, immediately discontinue use and see your physician about these symptoms.
- Mix and store fuel in a container approved for gasoline.
 - Mix fuel outdoors where there are no sparks or flames. Wipe up any fuel spillage. Move 30 ft. (9 m) away from refueling site before starting engine. Slowly remove the fuel cap after stopping engine. Do not smoke when refueling.

- Stop the engine and allow to cool before refueling or storing the unit.
- Allow the engine to cool; empty the fuel tank into a container approved for fuel and secure the unit from moving before transporting in a vehicle.
- Wear your protective equipment and observe all safety instructions. For units equipped with a clutch, be sure the cutting attachment stops turning when the engine idles. When the unit is turned off make sure the cutting attachment has stopped before the unit is set down.

Specific Safety Rules

- This product is intended for infrequent use by homeowners and other occasional users for such general applications as trimming light and heavy vegetation, etc. It is not intended for prolonged use. Prolonged periods of operation can cause circulatory problems in the user's hands due to vibration. For such use, it may be appropriate to use a product having an anti-vibration feature.

Specific Safety Rules for Trimmer Use

- Inspect before use. Replace damaged parts. Make sure fasteners are in place and secure. Check for fuel leaks.
- Replace string head if cracked, chipped, or damaged in any way. Be sure the string head or blade is properly installed and securely fastened. Failure to do so can cause serious injury.
- Make sure all guards, straps, deflectors, and handles are properly and securely attached.
- Use only the manufacturer's replacement line in the cutting head. Do not use any other cutting attachment. To install any other brand of replacement line or cutting head to this string trimmer can result in serious personal injury. Never use, for example, wire or wire-rope, which can break off and become a dangerous projectile.
- Never operate unit without the grass deflector in place and in good condition.
- Maintain a firm grip on both handles while trimming. Keep string head below waist level. Never cut with the string head located over 30 in. or more above the ground.

Specific Safety Rules for Brushcutter and Blade Use



- Brushcutter blades coast after throttle trigger is released or engine is stopped. Keep the rotating blade in thicker weeds or pulpy stalks until the blade completely stops.
- Do not operate the brushcutter unless the brushcutter guard is firmly secured in place and in good condition.
- Use heavy gloves when operating the brushcutter and when installing or removing blades.
- Always stop the engine and remove the spark plug wire before attempting to remove any obstruction caught or jammed in the blade or before removing and installing the blade.

- Do not attempt to touch or stop the blade when it is rotating.
- A coasting blade can cause injury while it continues to spin after the engine is stopped or throttle trigger released. Maintain proper control until the blade has completely stopped rotating.
- Replace any blade that has been damaged. Always make sure blade is installed correctly and securely fastened before each use. Failure to do so can cause serious injury.
- Use only the manufacturer's replacement blade intended for use on this brushcutter. Do not use any other blade. To install any other brand blade or cutting head to this brushcutter can result in serious personal injury.
- The blade is suited for cutting thicker weeds or pulpy stalks only. Do not use for any other purpose. Never use the blade to cut woody brush.
- Exercise extreme caution when using the blade with this unit. Blade thrust is the reaction that may occur when the spinning blade contacts anything it cannot cut. This contact may cause the blade to stop for an instant, and suddenly "thrust" the unit away from the object that was hit. This reaction can be violent enough to cause the operator to lose control of the unit. Blade thrust can occur without warning if the blade snags, stalls, or binds. This is more likely to occur in areas where it is difficult to see the material being cut. For cutting ease and safety, approach the weeds being cut from the right to the left. In the event an unexpected object or woody stock is encountered, this could minimize the blade thrust reaction.
- Never cut any material over 1/2 in. diameter.
- Always wear the shoulder harness when using the brushcutter and adjust to a comfortable operating position. Maintain a firm grip on both handles while cutting with a blade. Keep the blade away from your body and below waist level.
- Never use the brushcutter with the blade located 30 in. or more above the ground level.
- Save these instructions. Refer to them frequently and use them to instruct others who may use this tool. If you loan someone this tool, loan them these instructions also.







NOTE: ADDITIONAL SPECIFIC SAFETY RULES CAN BE FOUND IN THE APPLICABLE ATTACHMENT'S OPERATOR'S MANUAL

Symbols

The following signal words and meanings are intended to explain the levels of risk associated with this product.





SYMBOL	SIGNAL	MEANING
	DANGER:	Indicates an imminently hazardous situation, which, if not avoided, will result in death or serious injury.
	WARNING:	Indicates a potentially hazardous situation, which, if not avoided, could result in death or serious injury.
	CAUTION:	Indicates a potentially hazardous situation, which, if not avoided, may result in minor or moderate injury.
	NOTICE:	(Without Safety Alert Symbol) Indicates important information not related to an injury hazard, such as a situation that may result in property damage.

Some of the following symbols may be used on this product. Please study them and learn their meaning for safe operation of this product.

SYMBOL	NAME	EXPLANATION
	Safety Alert	Indicates a potential personal injury hazard.
	Read Operator's Manual	To reduce the risk of injury, user must read and understand operator's manual before using this product.
	Eye, Hearing and Head Protection	Always wear eye protection with side shields marked to comply with ANSI Z87.1, along with hearing protection. Head protection may also be required depending on the type of attachment used and as prescribed in the attachment's Operator's Manual.
	Keep Bystanders Away	Keep all bystanders at least 50 ft. (15 m) away.
	Ricochet	Thrown objects can ricochet and result in personal injury or property damage.
	No Blade	Do not install or use any type of blade on a product displaying this symbol.
	Gasoline and Oil	Use unleaded gasoline intended for motor vehicle use with an octane rating of 87 [(R + M)/2] or higher. This product is powered by a 2-cycle engine and requires pre-mixing gasoline and 2-cycle oil.

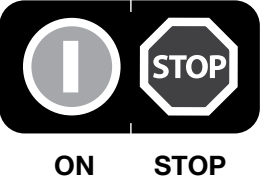
Product Labels

Product labels and instructions are easily visible to the operator and are located near any area of potential danger. Replace damaged or lost labels.

<p>Part No. 940686099</p>  <p>TO START</p> <ol style="list-style-type: none">1 Push bulb 8x2 Set choke lever to "FULL"3 SQUEEZE THROTTLE TRIGGER FULLY (THRU STEP 6) and pull starter handle sharply (no more than 4x)4 Set choke lever to "HALF"5 Pull starter handle until engine runs, no more than 6 pulls6 Set choke lever to "RUN" <p>For Help Call: 1-866-574-9242</p>	<p>Part No. 940864003</p>  <p>ON STOP</p>
<p>Part No. 940657034</p>  <p>Handle Position ↓</p>	<p>Part No. 940627020</p>  <p>TORO®</p>
<p>Part No. 940865001</p>  <p>TORO®</p>	

Features

Product Specifications

Name	Specification
Engine	25.4cc Full Crank
Weight	8.5 lbs.

Know Your Product

See Figure 1.

The safe use of this product requires an understanding of the information on the tool and in this operator's manual as well as a knowledge of the project you are attempting. Before use of this product, familiarize yourself with all operating features and safety rules, in both this manual and the operator's manuals for all attachments that you are using with this power head.

Engine

The engine is powerful and easy to start. It is effectively counterbalanced, which allows for less vibration and more durability.

Ergonomic Design

The design of the product provides for easy handling. It is designed for comfort and ease of grasp when operating in different positions and at different angles.

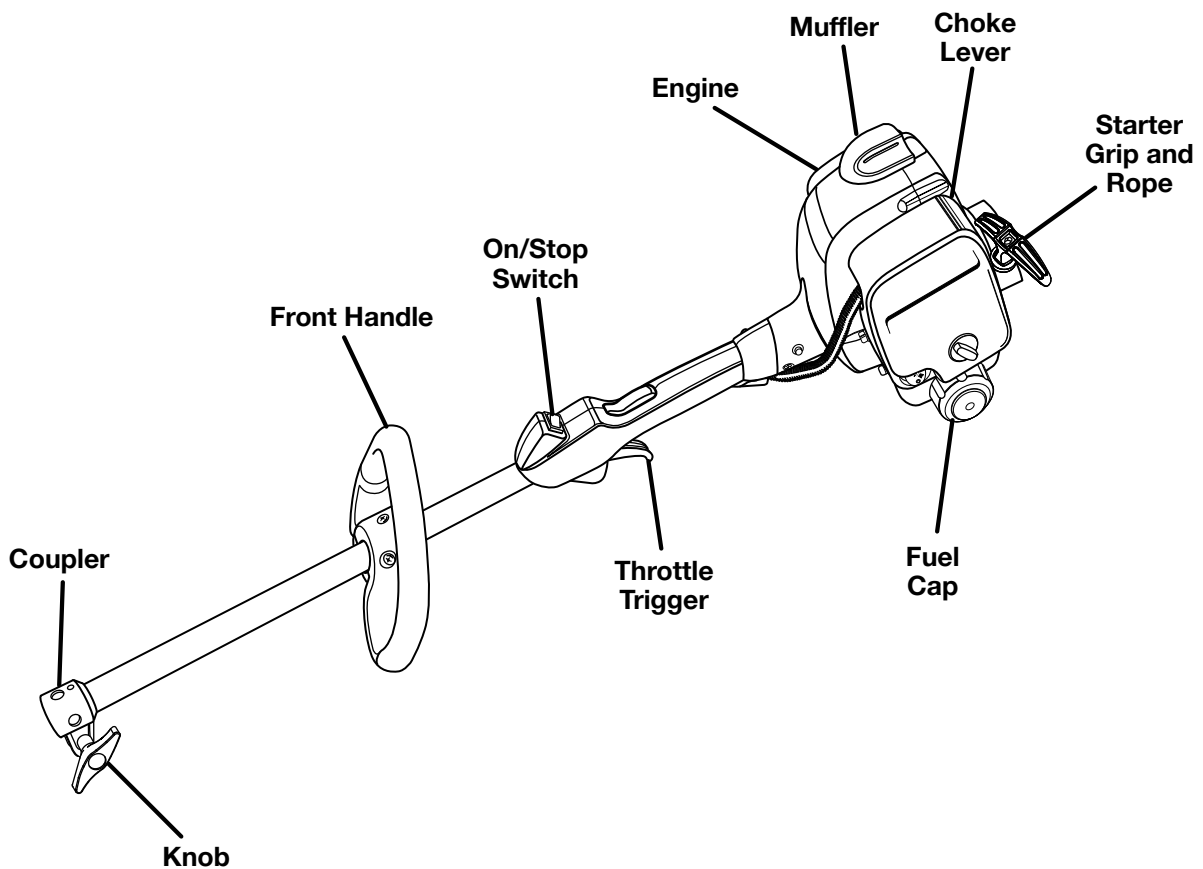

Figure 1

Assembly

Unpacking

This product requires assembly.

- Carefully remove the product and any accessories from the box. Make sure that all items listed in the packing list are included.

WARNING:

Do not use this product if any parts on the packing list are already assembled to your product when you unpack it. Parts on this list are not assembled to the product by the manufacturer and require customer installation. Use of a product that may have been improperly assembled could result in serious personal injury.

- Inspect the product carefully to make sure no breakage or damage occurred during shipping.
- Do not discard the packing material until you have carefully inspected and satisfactorily operated the product.
- If any parts are damaged or missing, please call 1-866-574-9242 (US) or 1-866-574-9243 (Canada) for assistance.

Packing List

Power Head Assembly

Front Handle

Lubricant

Operator's Manual

WARNING:

If any parts are damaged or missing do not operate this product until the parts are replaced. Use of this product with damaged or missing parts could result in serious personal injury.

WARNING:

Do not attempt to modify this product or create accessories not recommended for use with this product. Any such alteration or modification is misuse and could result in a hazardous condition leading to possible serious personal injury.

WARNING:

To prevent accidental starting that could cause serious personal injury, always disconnect the engine spark plug wire from the spark plug when assembling parts.

Connecting the Attachment to the Upper Shaft

See Figure 2.

WARNING:

Read and understand entire Operator's Manual for each optional attachment used on this power head and follow all warnings and instructions. Failure to follow all instructions can result in electric shock, fire and/or serious personal injury.

WARNING:

Never install, remove, or adjust any attachment while power head is running. Failure to stop the engine can cause serious personal injury. Never operate power head without an attachment.

WARNING:

Be certain the knob is fully tightened before operating equipment; check it periodically for tightness during use to avoid serious personal injury.

The attachment connects to the power head by means of a coupler device. Follow these steps to connect the attachment to the upper shaft.

1. Stop the engine and disconnect the spark plug wire.
2. Loosen the knob by turning it counterclockwise.
3. Remove the end cap from the attachment shaft.

4. Push in the button located on the attachment shaft. Align the button with the guide recess on the power head coupler and slide the two shafts together. Rotate the attachment shaft until the button locks into the positioning hole.

Note: If the button does not release completely in the positioning hole, the shafts are not locked into place. Slightly rotate from side to side until the button is locked into place.

5. Tighten the knob securely by turning it clockwise.

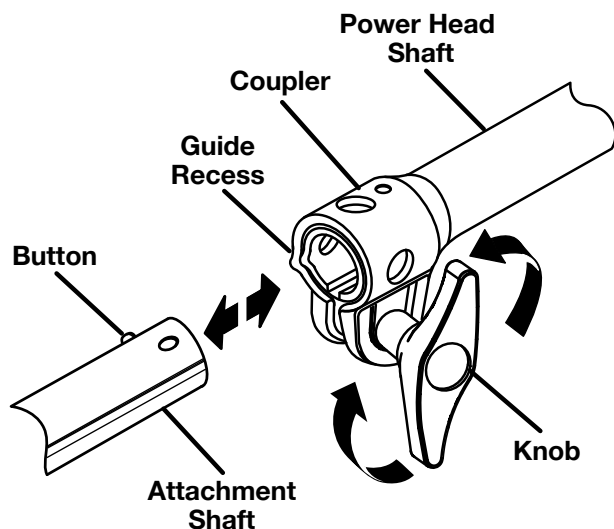

Figure 2

Removing the Attachment from the Upper Shaft

See Figure 2.

Follow these steps to remove the attachment from the upper shaft.

1. Stop the engine and disconnect the spark plug wire.
2. Loosen the knob by turning it counterclockwise.
3. Push in the button and twist the shafts to unlock and separate.

Attaching the Front Handle

See Figure 3.

Follow these steps to attach the front handle.

1. Remove the slotted Torx™ screws to separate the handle from the handle support.
2. Press the front handle onto the top of the upper shaft, in the position indicated by the arrow on the shaft, angling the handle toward the throttle trigger.
3. Place the front handle along the upper shaft to a position that allows for comfortable operation.
4. Place the handle support on the bottom of the shaft on the opposite side of the front handle.
5. Secure the handle with the slotted Torx™ screws using a T25 Torx driver or flat blade screwdriver.

Note: Do not cover any portion of the warning label with the front handle.

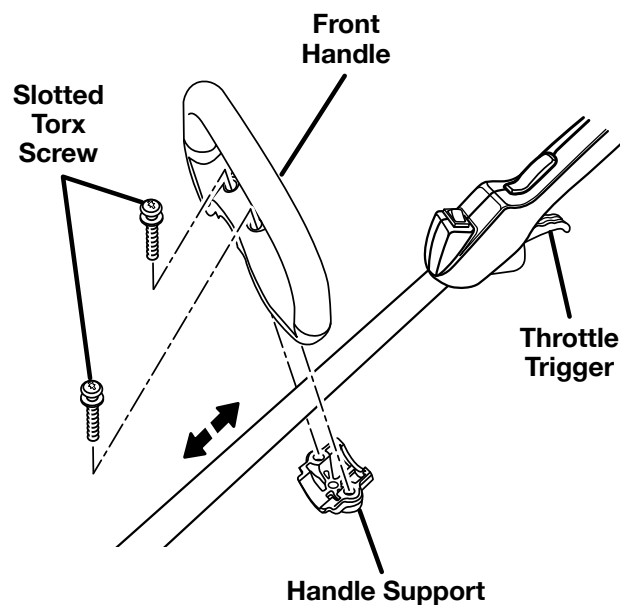

Figure 3

Operation

WARNING:

Do not allow familiarity with this product to make you careless. Remember that a careless fraction of a second is sufficient to inflict serious injury.

WARNING:

Always wear eye protection with side shields marked to comply with ANSI Z87.1, along with hearing protection. Head protection may also be required depending on the type of attachment used and as prescribed in the attachment's Operator's Manual. Failure to do so could result in objects being thrown into your eyes and other possible serious injuries.

WARNING:

Never use flailing devices, wire, or rope on this product. Do not use any attachments or accessories not recommended by the manufacturer of this tool. The use of attachments or accessories not recommended can result in serious personal injury.

WARNING:

Operation of this equipment can create sparks that can start fires around dry vegetation. A spark arrestor may be required. The operator should contact local fire agencies for laws or regulations relating to fire prevention requirements.

Applications

Use this product for the following applications when used with the appropriate attachment:

- Cutting grass, weeds, and light undergrowth
- Edging along sidewalks and driveways

Fueling and Refueling the Power Head

WARNING:

Gasoline and its vapors are highly flammable and explosive. To prevent serious personal injury and property damage, handle it with care. Keep away from ignition sources and open flames, handle outdoors only, do not smoke and wipe up spills immediately.

Fuel Mixture

This product is powered by a 2-cycle engine and requires pre-mixing gasoline and 2-cycle lubricant. Pre-mix unleaded gasoline and 2-cycle engine lubricant in a clean container approved for gasoline. DO NOT mix quantities larger than usable in a 30-day period.

Recommended fuel: This engine is certified to operate on unleaded gasoline intended for automotive use.

Note: We recommend you use high-quality synthetic 2-cycle lubricant in this product. Mix at 2.6 oz. per gallon (US).

Do not use automotive lubricant or 2-cycle outboard lubricant.

HIGH QUALITY 2-CYCLE ENGINE LUBRICANT



GASOLINE

LUBRICANT

1.0 gal. (US) (3.8 liter)

2.6 oz. (76 ml)

2.5 gal. (US) (9.5 liter)

6.4 oz. (189 ml)

Filling Tank

1. Clean surface around fuel cap to prevent contamination.
2. Loosen fuel cap slowly by turning counterclockwise. Rest the cap on a clean surface.
3. Carefully pour fuel into the tank. Avoid spillage.
4. Prior to replacing the fuel cap, clean and inspect the gasket.
5. Immediately replace fuel cap and hand tighten by turning clockwise. Wipe up any fuel spillage.
6. Move at least 30 ft. (9 m) away from refueling area before starting the product.

Note: It is normal for smoke to be emitted from a new engine after first use.

WARNING:

Always shut off engine before fueling. Never add fuel to a machine with a running or hot engine. Move at least 30 ft (9 m). from refueling site before starting engine. Do not smoke and stay away from open flames and sparks. Failure to safely handle fuel could result in serious personal injury.

Oxygenated Fuels

NOTICE:

Do not use E15, E20, or E85 fuel (or fuel containing greater than 10% ethanol) in this product. It is a violation of federal law and will damage the unit and void your warranty.

Fuel system damage or performance problems resulting from the use of an oxygenated fuel containing more than

the percentage of oxygenates stated below **are not covered under warranty**.

Ethanol. Gasoline containing up to 10% ethanol by volume (commonly referred to as E10) is acceptable. **E15 and E85 are not.**

Operating the Power Head

See Figure 4.

⚠ WARNING:

Engine housing may become hot during operation. Do not rest or place your arm, hand, or any body part against the engine housing during operation. Only hold the unit as shown in Figure 5 during trimmer operation with all body parts clear of engine housing (or as shown in the applicable attachment Operator's Manual). Extended contact with the engine housing can result in burns or other injuries.

⚠ WARNING:

Always position the unit on the operator's right side. The use of the unit on the operator's left side will expose the user to hot surfaces and can result in possible burn injury.

⚠ WARNING:

To avoid burns from hot surfaces, never operate unit with the bottom of the engine above waist level.

Hold the power head with your right hand on the rear handle and your left hand on the front handle. Keep a firm grip with both hands while in operation. Power head should be held at a comfortable position with the rear handle about hip height.

Always operate power head at full throttle. If debris becomes wrapped around the attachment, **STOP THE ENGINE**, disconnect the spark plug wire, and remove the debris. Prolonged cutting at partial throttle will result in lubricant dripping from the muffler.

⚠ WARNING:

Always hold the power head and attachment away from the body keeping clearance between the body and the product. Any contact with the power head or attachment cutting head can result in burns and/or other serious personal injury.

Proper Trimmer Operating Position



Figure 4

⚠ WARNING:

Extreme care must be taken when using blades to ensure safe operation. Read the safety information for safe operation when using a blade and refer to the safety rules and instructions in your attachment manual.

Blade Thrust

Exercise extreme caution when using a blade attachment with this unit. Blade thrust is the reaction that may occur when the spinning blade contacts anything it cannot cut. This contact may cause the blade to stop for an instant, and suddenly “thrust” the unit away from the object that was hit. This reaction can be violent enough to cause the operator to lose control of the unit. Blade thrust can occur without warning if the blade snags, stalls, or binds. This is more likely to occur in areas where it is difficult to see the material being cut. For cutting ease and safety, approach the weeds being cut with the brushcutter from the right to the left. In the event an unexpected object or woody stock is encountered, this practice could minimize the blade thrust reaction.

Starting the Product

See Figures 5 - 7.

Starting the product differs depending on whether the engine is cold or warm. Refer to the label on the air filter cover.

To Start a Cold Engine:

Follow these steps to start a cold engine.

1. Lay the product on a flat, bare surface.
2. Push the primer bulb eight times.
3. Set the choke lever to **FULL**.
4. Depress lock-out button and squeeze throttle trigger fully (thru step 7) and pull starter handle sharply until engine attempts to start (no more than 4x).
5. Set the choke lever to **HALF**.
6. Pull starter handle until engine runs, **no more than 6 pulls**.
7. Set the choke lever to **RUN**.

Note: In cooler environments, additional pulls of the starter handle may be required with the choke lever in the **FULL** position.

To Start a Warm Engine:

Follow these steps to start a warm engine.

1. Lay the product on a flat, bare surface.
2. Push the primer bulb up to eight times.
3. Set the choke lever to **RUN**.
4. Depress lock-out button and squeeze throttle trigger fully, pull the starter cord.

Note: If the product does not start, repeat the previous steps.

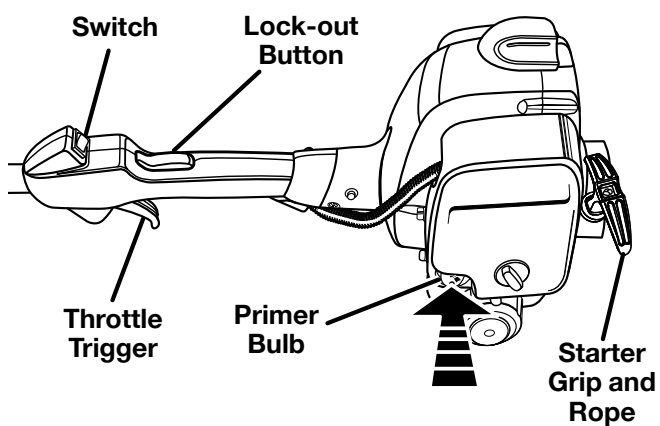
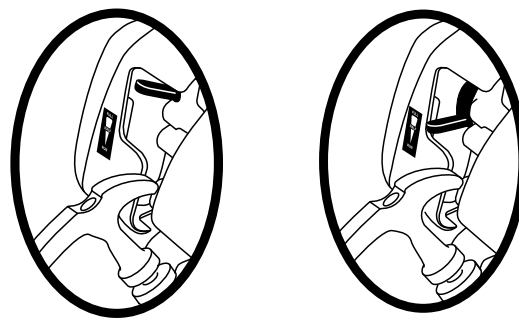

Figure 5



Set Choke to FULL

Set Choke to RUN

Figure 6

Stopping the Product

See Figure 7.

Follow these steps to stop the product.

1. Release the trigger.
2. Press and hold on/stop switch to **(STOP)** position until the engine stops. The switch will automatically return to the **(ON)** position when released.

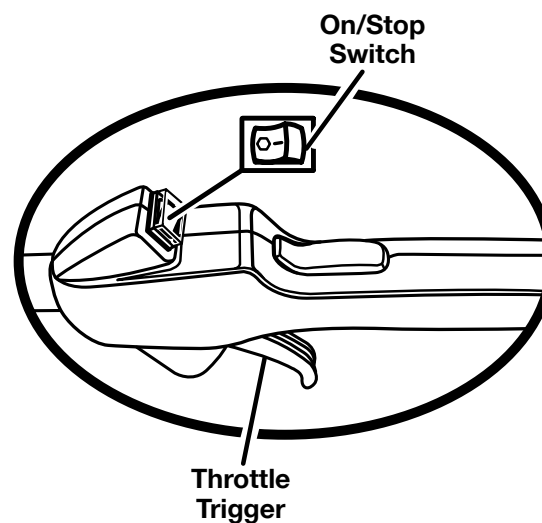

Figure 7

Maintenance

⚠ WARNING:

Use only Toro replacement parts when servicing this product. Use of any other parts could create a hazard or cause product damage.

⚠ WARNING:

Always wear eye protection with side shields marked to comply with ANSI Z87.1, along with hearing protection. Head protection may also be required depending on the type of attachment used and as prescribed in the attachment's Operator's Manual. Failure to do so could result in objects being thrown into your eyes and other possible serious injuries.

⚠ WARNING:

Before inspecting, cleaning, or servicing the machine, shut off engine, wait for all moving parts to stop, and disconnect spark plug wire and move it away from spark plug. Failure to follow these instructions can result in serious personal injury or property damage.

General Maintenance

Avoid using solvents when cleaning plastic parts. Most plastics are susceptible to damage from various types of commercial solvents and may be damaged by their use. Use clean cloths to remove dirt, dust, lubricant, grease, etc.

⚠ WARNING:

Do not at any time let brake fluids, gasoline, petroleum-based products, penetrating lubricants, etc., come in contact with plastic parts. Chemicals can damage, weaken or destroy plastic which can result in serious personal injury.

Cleaning the Product

1. Stop the product before cleaning.
2. Clean the exterior of the product with a damp cloth.
3. Avoid using solvents when cleaning plastic parts. Most plastics are susceptible to damage from various types of commercial solvents and may be damaged by their use.
4. Wipe or scrape the trimmer head and spool area when they accumulate dirt or clippings.
5. Scrape debris away from air intake vents on both sides of the motor housing.

NOTICE:

Keeping air intake vents free of grass and debris prevents motor overheating and possible failure.

Servicing the Product

Check and tighten all fasteners. If any part is damaged or lost, repair it or replace it.

Checking the Fuel Cap, Tank, and Lines

⚠ WARNING:

Check for fuel leaks. A leaking fuel cap, tank, or lines are a fire hazard and must be replaced immediately. If you find any leaks, correct the problem before using the product. Failure to do so could result in a fire that could cause serious personal injury.

The fuel cap contains a non-serviceable filter and check valve. A clogged fuel filter causes poor engine performance. If performance improves when the fuel cap is loosened, the check valve may be faulty or the filter may be clogged. Replace the fuel cap if necessary.

Cleaning the Air Filter

See Figure 8.

Clean the air filter as indicated by the maintenance schedule. Follow these steps to clean the air filter.

1. Stop the trimmer.
2. Remove the spark plug boot.
3. Loosen the air filter cover by turning the knob counter clockwise.
4. Remove the air filter cover.
5. Remove the air filter.
6. Clean the air filter with warm soapy water.

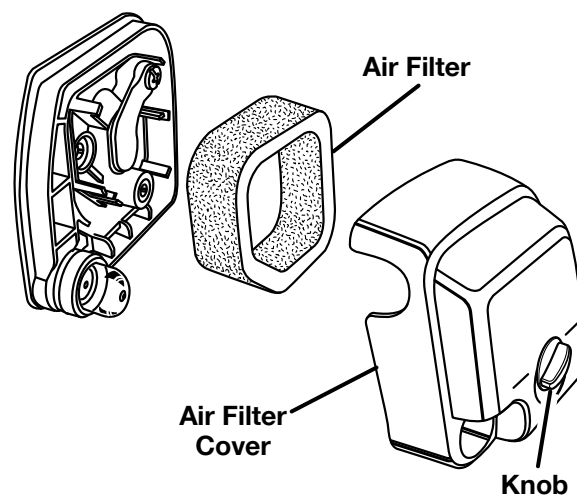

Figure 8

7. Rinse the air filter and let it dry completely.
8. Work two drops of oil into the air filter.
9. Replace the air filter (fits only one way).
10. Replace the air filter cover.
11. Tighten the air filter cover by turning the knob clockwise.
12. Replace the spark plug boot.

Note: Replace the air filter as indicated by the maintenance schedule.

Replacing the Spark Arrestor

See Figure 9.



WARNING:

Stop engine, remove spark plug boot, and allow engine and muffler to cool before replacing the spark arrestor. Contact with a hot muffler or engine could cause burns or other serious personal injuries.

Note: Depending on the type of fuel used, the type and amount of lubricant used, and/or your operating conditions, the exhaust port, muffler, and/or spark arrestor screen may become blocked with carbon deposits. If you notice a power loss with your gas powered tool, you may need to remove these deposits to restore performance. We highly recommend that only qualified service technicians perform this service.

The spark arrestor may need to be cleaned or replaced after repeated use. If replacement is necessary, use Toro part number 000998216.

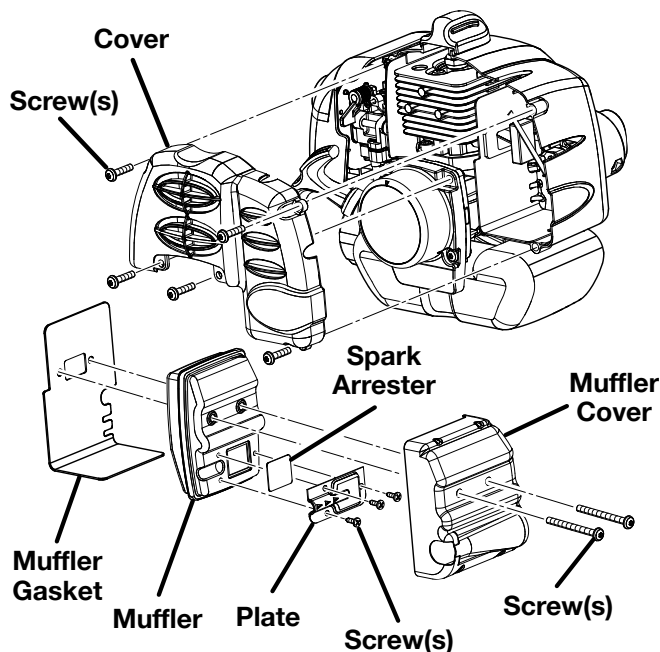

Figure 9

To replace the spark arrestor:

1. Remove the five screws that hold the cover.
 - Note:** Removing these screws requires the use of a T20 and T25 torx screwdriver.
2. Remove the cover.
3. Remove the two screws holding the muffler assembly in place.
4. Remove the muffler assembly and muffler gasket. It may be necessary to work the muffler assembly free from the muffler gasket.
5. Separate the muffler cover from the muffler.
6. Remove the three screws that hold the plates on the muffler.
7. Remove the spark arrestor.
8. Replace the old spark arrestor with the new one.
9. Reassemble the muffler by reinstalling the plates and tightening the three screws [torque to 18 in.lb. (2.03 Nm) minimum, 22 in.lb. (2.49 Nm) maximum].
10. Reassemble the muffler and muffler cover and attach to the muffler gasket with the two screws.
11. Reinsert the muffler assembly and tighten two screws to engine [torque to 60 in.lb (6.78 Nm) minimum, 80 in.lb. (9.04 Nm) maximum].
12. Reinstall the cover on the tool and fasten with the five screws [torque to 16 in.lb. (1.81 Nm) minimum, 22 in.lb. (2.49 Nm) maximum].

Note: Do not overtighten screws.

Replacing the Spark Plug

See Figure 10.

All model numbers included in this manual use a Champion RCJ4 or RCJ6Y spark plug. Use an exact replacement and replace annually.

1. Remove the spark plug boot.
2. Loosen the spark plug by turning it counterclockwise with a socket.

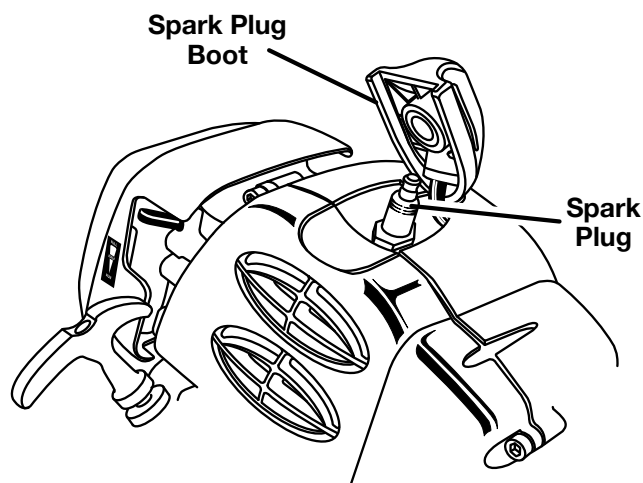

Figure 10

3. Remove the spark plug.
4. Inspect the new spark plug. The spark plug must be properly gapped and free of deposits in order to ensure proper engine operation. The correct gap is approximately 0.025 in. (0.64 mm). To widen gap, if necessary, carefully bend the ground (top) electrode. To lessen gap, gently tap ground electrode on a hard surface.
5. Hand thread the new spark plug, turning it clockwise.
6. Tighten with a socket. [Torque to 170 in.lb. (19.20 Nm) minimum, 190 in.lb. (21.47 Nm) maximum. **Do not overtighten**].

NOTICE:

Be careful not to cross-thread the spark plug. Cross-threading will seriously damage the product.

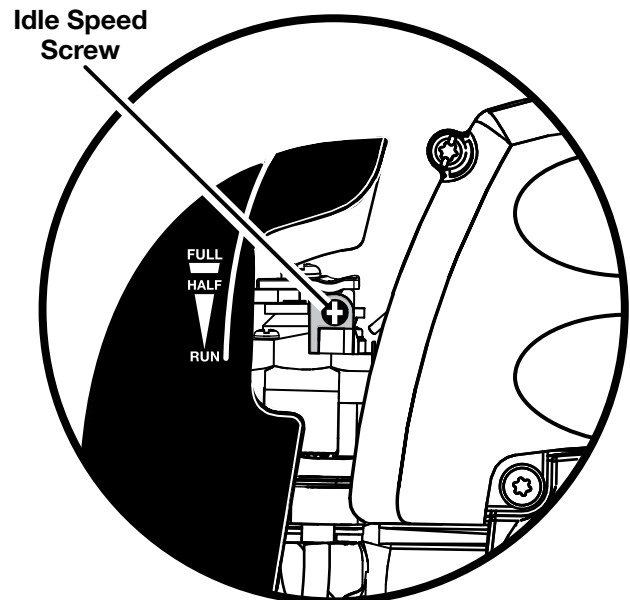

Figure 11

Idle Speed Adjustment

See Figure 11.

⚠ WARNING:

The blade/cutting head will move when adjusting the idle speed. Wear all protective clothing and keep all bystanders, children, and pets at least 50 ft (15 m) away. Make adjustments with the unit supported by hand so that the blade/cutting head does not contact the ground or any object. Keep all parts of your body away from the blade/cutting head and muffler. Failure to follow these instructions could result in serious personal injury.

If the cutting attachment turns at idle, the idle speed screw needs adjusting on the engine. Turn the idle speed screw counterclockwise to reduce the idle RPM and stop the cutting attachment movement. If the cutting attachment still moves at idle speed, contact a service dealer for adjustment and discontinue use until the repair is made.

⚠ WARNING:

The cutting attachment should never turn at idle. Turn the idle speed screw counterclockwise to reduce the idle RPM and stop the cutting attachment, or contact a service dealer for adjustment and discontinue use until the repair is made. Serious personal injury can result from the cutting attachment turning at idle.

Storing the Product

Storing the product differs depending on the amount of time it will be in storage.

Note: If the product includes an attachment, place the storage cap on the end of the attachment shaft and hang it up to store.

To Store the Product Short Term:

1. Clean all foreign material from the product.
2. Store the product in a well-ventilated place that is inaccessible to children.

To Store the Product Long Term:

If you do not intend to use the product for more than one month, follow the storage procedures below.

Follow these steps to store the product long term.

1. Drain all of the fuel from the tank into a container approved for gasoline.
2. Run the engine until it stops.
3. Clean all foreign material from the product.
4. Store the product in a well-ventilated place that is inaccessible to children.

Note: Keep the product away from corrosive agents such as garden chemicals and de-icing salts.

Note: Abide by all federal and local regulations for the safe storage and handling of gasoline.

Transporting the Product

1. Drain the fuel mixture into a container that is approved for use with gasoline.
2. Carry the product by the front handle.
3. Secure the product in your vehicle or on a trailer.

High Altitude Engine Operation

Please have an authorized service center adjust this engine if it is to be run above 2000 feet. Failure to do so may result in poor engine performance and increased emissions. An engine adjusted for high altitudes can not be run at 2000 feet or lower. In doing so, the engine will overheat and cause serious engine damage. Please have an authorized service center restore high altitude modified engines to the original factory specification before operating below 2000 feet.

This Product Was Manufactured With A Catalyst Muffler

Congratulations! You have made an investment toward protecting the environment. In order to maintain this product's original emission level, please refer to the maintenance section below.

MAINTENANCE SCHEDULE				
Maintenance Part	Inspect for Damage Before Each Use	Clean Every 5 Hours	Clean or Replace Every 25 Hours or Yearly	Replace Every 125 Hours
*CATALYTIC MUFFLER ASSEMBLY				X
SPARK SCREEN			X	
*AIR FILTER ASSY				
includes:				
Filter		X		
*CARBURETOR ASSY				
includes:				
Gaskets	X			
*FUEL TANK ASSY				
includes:				
Fuel Lines	X			
Fuel Cap	X			
Fuel Filter			X	
*IGNITION ASSY				
includes:				
Spark Plug			X	
*NOTICE: THE USE OF EMISSION CONTROL COMPONENTS OTHER THAN THOSE DESIGNED FOR THIS UNIT IS A VIOLATION OF FEDERAL LAW.				



CALL US FIRST

For any questions about operating or maintaining your product, call the Toro® Help Line!

Your product has been fully tested prior to shipment to ensure your complete satisfaction.

Troubleshooting

Problem	Possible Cause	Solution
Engine will not start	<ol style="list-style-type: none"> 1. No spark 2. No fuel 3. Flooded engine 4. Starter cord pulls harder now than when new 	<ol style="list-style-type: none"> 1. Remove the spark plug. Reattach the spark plug cap and lay the spark plug on the metal cylinder. Pull the starter cord and watch for a spark at the spark plug tip. If there is no spark, repeat the test with a new spark plug. 2. Push primer bulb until the bulb is full of fuel. If the bulb does not fill, the primary fuel delivery system is blocked. If the primer bulb fills, the engine may be flooded. (See next item.) 3. Remove the spark plug. Turn the product so that the spark plug hole is aimed at the ground. Make sure the choke lever is set to RUN and pull the starter cord 10 to 14 times. This clears excess fuel from the engine. Clean and reinstall the spark plug. With the trigger fully depressed, pull the starter cord 3 times. If the engine does not start, set the choke lever to FULL and follow normal starting instructions. If the engine still fails to start, repeat the procedure with a new spark plug. 4. Contact an authorized service dealer.
Engine does not reach full speed and emits excessive smoke	<ol style="list-style-type: none"> 1. Check oil fuel mixture 2. Air filter is dirty 3. Spark arrestor screen is dirty 	<ol style="list-style-type: none"> 1. Use fresh fuel and the correct 2-cycle oil mix. 2. Clean the air filter. 3. Clean the spark arrestor.
Oil drips from muffler	<ol style="list-style-type: none"> 1. Operating the product at part throttle 2. Check oil/fuel mixture 3. Air filter is dirty 	<ol style="list-style-type: none"> 1. Operate the product at full throttle. 2. Use fresh fuel and the correct 2-cycle oil mix. 3. Clean the air filter.

Warranty



Count on it.

THIS PRODUCT IS MANUFACTURED UNDER LICENSE FROM THE TORO COMPANY BY TECHTRONIC INDUSTRIES NORTH AMERICA, INC.

Techtronic Industries north America, Inc. warrants to the original retail purchaser that this gas trimmer Product is free from defects in material and workmanship and agrees to repair or replace, at our option, any defective Product free of charge within these time periods from the date of purchase:

- Three years for Gas Power Head, if the Product is used for personal, family, or household use;
- 90 days, if Gas Power Head is used for any other purpose, such as commercial or rental.
- Three years for emissions control systems on Gas Power Head used for any purpose, as provided below.

Except as provided in the Emission Control Warranty Statement, this warranty extends to the original retail purchaser only and commences on the date of original retail purchase.

Instructions for Obtaining Warranty Service

Any part of the Product manufactured or supplied by Techtronic Industries North America, Inc. and found in the reasonable judgement of Techtronic Industries North America, Inc. to be defective in material or workmanship will be repaired or replaced by an authorized service dealer for this product without charge for parts and labor. To locate your nearest authorized service dealer for this product, contact us Toll free at 1-866-574-9242 (US) or 1-866-574-9243 (Canada).

The Product including any defective part must be returned to an Authorized Service Dealer for this product within the warranty period. The expense of delivering the Gas Power Head to the service dealer for warranty work and the expense of returning it back to the owner after repair or replacement will be paid for by the owner. Techtronic Industries North America, Inc.'s responsibility in respect to claims is limited to making the required repairs or replacements and no claim of breach of warranty shall be cause for cancellation or rescission of the contract of sale of any Product. Proof of purchase will be required by the dealer to substantiate any warranty claim. All warranty work must be performed by a service dealer authorized by Techtronic Industries North America, Inc. to service this product.

This warranty does not cover any Gas Power Head that has been subject to misuse, neglect, negligence, or accident, or that has been operated in any way contrary to the operating instructions as specified in the Operator's Manual. This warranty does not apply to any damage to the Gas Power Head that is the result of improper maintenance or to any

Gas Power Head that has been altered or modified so as to adversely affect the products operation, performance or durability or that has been altered or modified so as to change its intended use. The warranty does not extend to repairs made necessary by normal wear or by the use of parts or accessories which are either incompatible with the Gas Power Head or adversely affect its operation, performance or durability.

In addition, this warranty does not cover the following (except to the extent covered by the emissions control warranty set forth below):

- A. Tune-ups – Spark Plugs, Carburetor Adjustments, Filters
- B. Wear Items – Starter Pulley and Starter Ropes

Techtronic Industries North America, Inc. reserves the right to change or improve the design of any Gas Power Head without assuming any obligation to modify any product previously manufactured.

ALL IMPLIED WARRANTIES ARE LIMITED IN DURATION TO THE STATED WARRANTY PERIOD. ACCORDINGLY, ANY SUCH IMPLIED WARRANTIES INCLUDING MERCHANTABILITY, FITNESS FOR A PARTICULAR PURPOSE, OR OTHERWISE, ARE DISCLAIMED IN THEIR ENTIRETY AFTER THE EXPIRATION OF THE APPROPRIATE THREE-YEAR OR NINETY DAY WARRANTY PERIOD. TECHTRONIC INDUSTRIES NORTH AMERICA, INC.'S OBLIGATION UNDER THIS WARRANTY IS STRICTLY AND EXCLUSIVELY LIMITED TO THE REPAIR OR REPLACEMENT OF DEFECTIVE PARTS AND TECHTRONIC INDUSTRIES NORTH AMERICA, INC. DOES NOT ASSUME OR AUTHORIZE ANYONE TO ASSUME FOR THEM ANY OTHER OBLIGATION. SOME STATES DO NOT ALLOW LIMITATIONS ON HOW LONG AN IMPLIED WARRANTY LASTS, SO THE ABOVE LIMITATION MAY NOT APPLY TO YOU.

TECHTRONIC INDUSTRIES NORTH AMERICA, INC. ASSUMES NO RESPONSIBILITY FOR INCIDENTAL, CONSEQUENTIAL, OR OTHER DAMAGES INCLUDING, BUT NOT LIMITED TO EXPENSE OF RETURNING THE GAS POWER HEAD TO A GAS POWER HEAD AUTHORIZED SERVICE DEALER AND EXPENSE OF DELIVERING IT BACK TO THE OWNER, MECHANIC'S TRAVEL TIME, TELEPHONE, OR TELEGRAM CHARGES, RENTAL OF A LIKE PRODUCT DURING THE TIME WARRANTY SERVICE IS BEING PERFORMED, TRAVEL, LOSS, OR DAMAGE TO PERSONAL PROPERTY, LOSS OF REVENUE, LOSS OF USE OF THE PRODUCT, LOSS OF TIME, OR INCONVENIENCE. SOME STATES DO NOT ALLOW THE EXCLUSION OR LIMITATION OF INCIDENTAL OR CONSEQUENTIAL DAMAGES, SO THE ABOVE LIMITATION OR EXCLUSION MAY NOT APPLY TO YOU.

This warranty gives you specific legal rights, and you may also have other rights, which vary, from state to state.



Customer Service Information

If your product requires service or maintenance, contact your nearest authorized service dealer. To locate your nearest authorized service dealer for this product, contact us toll free at 1-866-574-9242 (US) or 1-866-574-9243 (Canada).

This product is assembled by Techtronic Industries North America, Inc. under license from the Toro Company

Techtronic Industries North America, Inc.

P.O. Box 35 Highway 8

Pickens, SC 29671

USA