



MODEL NO. 30789- 40001 thru
80001 & UP

OPERATOR'S
MANUAL

GROUNDMASTER® 345
TRACTION UNIT

To understand this product, and for safety and optimum performance, read this manual before starting the engine. Pay special attention to SAFETY INSTRUCTIONS highlighted by this symbol.



It means CAUTION, WARNING or DANGER – personal safety instruction. Failure to comply with the instruction may result in personal injury.



The GROUNDMASTER® 345 conforms to the American National Standards Institute's safety standards for riding mowers when weights are installed according to chart on page 15.

FOREWORD

The GROUNDMASTER® 345 was developed to satisfy the demand for a maneuverable, intermediate size, turf maintenance rotary mower. The machine has advanced concepts in engineering and design, and if maintained properly, it will give excellent service.

Since the GROUNDMASTER® 345 is a high-quality product, Toro is concerned about the future use of the machine and safety of the user. Therefore, read this manual to familiarize yourself with proper set-up operation and maintenance instructions. The major sections of the manual are:

1. Safety Instructions
2. Set-Up Instructions
3. Before Operating
4. Operating Instructions
5. Maintenance

Certain information in this manual is emphasized. **DANGER**, **WARNING**, and **CAUTION** identify personal safety-related information. **IMPORTANT** identifies mechanical information demanding special attention. Be sure to read the directive because it deals with the possibility of damaging a part or parts of the machine. **NOTE** identifies general information worthy of special attention.

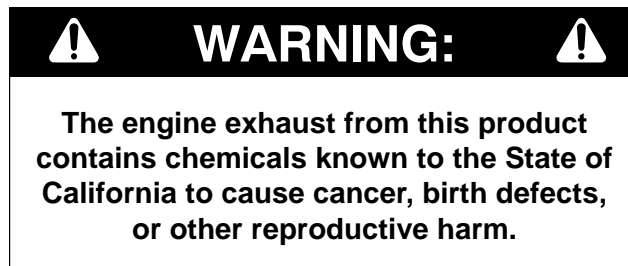

SPARK ARRESTOR

Because in some areas there are local, state, or federal regulations requiring that a spark arrestor be used on the engine of this mower, a spark arrestor is incorporated with the muffler assembly.

These parts are approved by the United States Department of Agriculture Forestry Service.

When the mower is used or operated on any California forest, brush or grass covered land, a properly operating spark arrestor must be attached to the muffler. The operator is violating state law, Section 442 Public Resources Code if a spark arrestor is not used.

If help concerning set-up, operation, maintenance, or safety is ever needed, contact the local Authorized TORO Distributor. In addition to genuine TORO replacement parts, the distributor also has optional equipment for the complete line of TORO turf care equipment. Keep your Toro all TORO. Buy genuine TORO replacement parts and accessories.

A service and overhaul manual, form no. 83-400-ST is available from your Authorized TORO Distributor.

TABLE OF CONTENTS

SAFETY INSTRUCTIONS	4-6	Changing Crankcase Oil and Filter	27
SAFETY AND INSTRUCTION DECALS	6-7	Replacing Fuel Filter	27
SPECIFICATIONS	8-9	Servicing Engine Belts	28
LOOSE PARTS	10	Replacing Spark Plugs	28
SET-UP INSTRUCTIONS	10-15	Changing Coolant in Cooling System	28
BEFORE OPERATING	15-18	Adjusting Governor	29
Check Crankcase Oil	15	Checking Oil Level in Governor	30
Fill Fuel Tank with Gasoline	16	Servicing Spark Arrestor Muffler	30
Check Cooling System	16	TRACTION DRIVE MAINTENANCE	31-32
Check Hydraulic System Oil	17	Adjusting Traction Control Rod	31
CONTROLS	17-19	Adjusting Traction Pedal Friction Wheel	31
OPERATING INSTRUCTIONS	20-22	Adjusting Traction Drive for Neutral	31
Starting/Stopping Engine	20	Adjusting Traction Interlock Switch	32
Checking Interlock Switches	20	PTO DRIVE MAINTENANCE	32
Pushing or Towing Traction Unit	20	Correcting PTO Drive Belt Slippage	32
Operating Characteristics	21	STEERING MAINTENANCE	33
DAILY MAINTENANCE CHECKLIST	22	Adjusting Tilt Steering Control	33
LUBRICATION MAINTENANCE	23	Adjusting Rear Wheel Toe-In	33
Greasing Bearings, Bushings & Brake Cables .	23	BRAKE MAINTENANCE	34
ELECTRICAL MAINTENANCE	24-25	Adjusting Brakes	34
Replacing Seat Switch	24	HYDRAULIC SYSTEM MAINTENANCE	35
Replacing PTO Switch	24	Adjusting Lift Lever Latch	35
Servicing Battery	25	Replacing Hydraulic Oil Filter	35
WIRING SCHEMATIC	25	Changing Hydraulic System Oil	35
AIR CLEANER MAINTENANCE	26-27	HYDRAULIC SCHEMATIC	37
General Maintenance Practices	26	IDENTIFICATION AND ORDERING	38
Servicing Dust Cup and Baffle	26	PREPARATION FOR SEASONAL STORAGE ...	38
Servicing Air Cleaner Filter	26	MAINTENANCE SCHEDULE	39
Inspecting Filter Element	27	THE TORO PROMISE	40
ENGINE MAINTENANCE	27-30		
Cleaning Radiator and Screen	27		



SAFETY INSTRUCTIONS

The **GROUNDMASTER® 345** was tested and certified by **TORO** for compliance with the **B71.4—1990** specifications of the **American National Standards Institute**. Although hazard control and accident prevention partially are dependent upon the design and configuration of the machine, these factors are also dependent upon the awareness, concern, and proper training of the personnel involved in the operation, transport, maintenance, and storage of the machine. Improper use or maintenance of the machine can result in injury or death. To reduce the potential for injury or death, comply with the following safety instructions.

BEFORE OPERATING

1. Read and understand the contents of this manual before starting and operating the machine. Become familiar with all controls and know how to stop quickly. A free replacement manual is available by sending complete Model and Serial Numbers to:

The Toro Company
8111 Lyndale Avenue South
Minneapolis, Minnesota 55420–1196

2. Never allow children to operate the machine. Do not allow adults to operate the machine without proper instruction. Only trained operators, skilled in slope operation and who have read this manual should operate this machine.

3. Never operate machine when under the influence of drugs or alcohol.

4. Remove all debris or other objects that might be picked up and thrown by cutter blades or fast moving components from other attached implements. Keep all bystanders away from the operating area.

5. Keep all shields and safety devices in place. If a shield, safety device, or decal is defective or damaged, repair or replace it before operation is commenced. Also, tighten any loose nuts, bolts, and screws to insure machine is in safe operating condition.

6. Do not wear loose-fitting clothing because it could get caught in moving parts. Always wear long pants and substantial shoes. Wearing safety glasses, safety shoes, and a helmet is advisable and required by some local ordinances and insurance regulations.

7. Check interlock switches daily for proper operation (Refer To Checking Interlock Switches, Page 20). Do not rely entirely on safety switches -shut off engine before getting off seat. If a switch fails, replace it before operating the machine. The interlock system is for your protection, so do not bypass it. Replace all interlock switches every two years. Interlock switches should be adjusted so:

A. Engine cannot be started unless traction pedal is released (neutral position) and PTO lever is **DISENGAGED** (off position).

B. Engine stops if operator gets off seat when traction pedal is depressed.

C. Engine stops if operator gets off seat when PTO lever is **ENGAGED** (on position).

8. Grass deflectors must be installed in lowest position on side discharge units and properly attached to Triflex cutting unit wings.

9. Fill fuel tank with fuel before starting the engine. Avoid spilling any fuel. Since fuel is flammable, handle it carefully.

A. Use an approved fuel container.

B. Do not fill fuel tank when engine is hot or running.

C. Do not smoke while handling fuel.

D. Fill fuel tank outdoors and up to about one inch (25 mm) from the top of the tank, not the filler neck.

E. Wipe up any spilled fuel.

WHILE OPERATING

10. Sit on the seat when starting the engine and operating the machine.

11. Before starting the engine:

A. Engage parking brake.

B. Make sure traction pedal is in neutral and PTO is in **OFF** (disengage) position.

C. After engine is started, release parking brake and keep foot off traction pedal. Machine must not move. If movement is evident, the neutral return mechanism is adjusted incorrectly. Shut engine off and adjust until machine does not move when traction pedal is released.

12. Do not run the engine in a confined area without adequate ventilation. Exhaust fumes are hazardous and could possibly be deadly.

13. Maximum seating capacity is one person. Therefore, never carry passengers.



SAFETY INSTRUCTIONS

14. Using the machine demands the operator's complete attention. To prevent loss of control:

- A. Operate only in daylight or when there is good artificial light.
- B. Drive slowly.
- C. Avoid sudden stops and starts.
- D. Look behind machine before backing up.
- E. Watch for holes or other hidden hazards.
- F. Do not drive close to a sand trap, ditch, creek, or hazard.
- G. Reduce speed when making sharp turns and when turning on a hillside.
- H. The cutting deck must be lowered when going down slopes for steering control.

15. Operator must be skilled and trained in how to drive on hillsides. Failure to use caution on slopes or hills may cause loss of control and vehicle to tip or roll possibly resulting in personal injury or death.

16. This product may exceed noise levels of 85 dB(A) at the operator position. Ear protectors are recommended for prolonged exposure to reduce the potential of permanent hearing damage.

17. Traverse slopes carefully. Do not start or stop suddenly when traversing slopes or when traveling uphill or downhill.

18. If engine stalls or machine loses headway and cannot make it to the top of a slope, do not turn machine around. Always back slowly straight down the slope.

19. The grass deflector(s) must always be installed and in lowest position on the cutting unit. This product is designed to drive objects into the ground where they lose energy quickly in grassy areas. However, don't take an injury risk!! When a person or pet appears unexpectedly in or near the mowing area, STOP MOWING. Careless operation, combined with terrain angles, ricochets, or improperly positioned guards, can lead to thrown object injuries. Do not resume mowing until area is cleared.

20. Never raise the cutting unit or other attached implement while the blades or other parts are rotating.

21. If cutting blades or other implement components strike a solid object or the machine vibrates abnormally, disengage PTO, move throttle to SLOW, set parking brake, and shut engine off. Remove key from switch to prevent possibility of accidental starting. Check cutting unit or other implement and traction unit for damage and defective parts. Repair any damage before restarting the engine and operating the

implement or cutting unit. Assure cutting unit blades are in good condition and blade bolts are torqued to proper specifications (See Cutting Deck Operator's Manual).

22. To stop machine, remove foot from traction pedal and use brakes. Gradually reversing the traction pedal can provide additional braking.

23. Do not touch engine, muffler, or radiator while engine is running or soon after it has stopped. These areas could be hot enough to cause a burn.

24. Lower the cutting unit or other attached implement to the ground and remove key from switch whenever machine is left unattended.

25. Before getting off the seat:

- A. Move traction pedal to neutral position and remove foot from pedal.
- B. Set the parking brake and disengage the PTO.
- C. Shut the engine off and remove key from ignition switch. Wait for all movement to stop before getting off the seat.

MAINTENANCE

26. Remove key from ignition switch to prevent accidental starting of the engine when servicing, adjusting, or storing the machine.

27. If major repairs are ever needed or assistance is desired, contact an Authorized TORO Distributor.

28. To reduce potential fire hazard, keep the engine free of excessive grease, grass, leaves, and accumulations of dirt.

29. If the cutting unit discharge area ever plugs, disengage PTO and shut engine off before removing the obstruction.

30. Make sure machine is in safe operating condition by keeping nuts, bolts, and screws tight. Check all cutting unit blade mounting bolts frequently to assure they are torqued to proper specifications (See Cutting Deck Operator's Manual).

31. Make sure all hydraulic line connectors are tight, and all hydraulic hoses and lines are in good condition before applying pressure to the system.

32. Keep body and hands away from pin hole leaks or nozzles that eject hydraulic fluid under high pressure. Use paper or cardboard, not hands, to search for leaks. Hydraulic fluid escaping under pressure can have sufficient force to penetrate skin and do serious damage. If fluid is ejected into the skin, it must be surgically removed within a few hours by a doctor familiar with this form of injury or gangrene may result.



SAFETY INSTRUCTIONS

33. Before disconnecting or performing any work on the hydraulic system, all pressure in system must be relieved by stopping engine and lowering implement to the ground.

34. If the engine must be running to perform maintenance or an adjustment, keep clear of PTO shaft, cutting unit blades, and other moving parts.

35. Do not overspeed the engine by changing the governor settings. Maximum engine speed with no load is 3300 rpm. To ensure safety and accuracy, have

an Authorized TORO Distributor check maximum engine speed with a tachometer.

36. Engine must be shut off before checking oil or adding oil to the crankcase.

37. At the time of manufacture, the machine conformed to safety standards in effect for riding mowers. To ensure optimum performance and continued safety certification of the machine, use genuine TORO replacement parts and accessories. Replacement parts and accessories made by other manufacturers may result in non-conformance with the safety standards, and the warranty may be voided.

SAFETY AND INSTRUCTION DECALS

The following safety and instruction decals are mounted on the traction unit. If any decal becomes damaged or illegible, install a new decal. Part numbers are listed below or in your parts catalog.



ON RADIATOR FAN SHROUD
(Part No. 76-8750)



ON RADIATOR FAN SHROUD
(Part No. 77-3100)

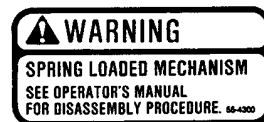

ON LIFT ARM AND PUSH ARMS
(Part No. 55-4300)



FORWARD OF TRACTION PEDAL
(Part No. 27-7320)

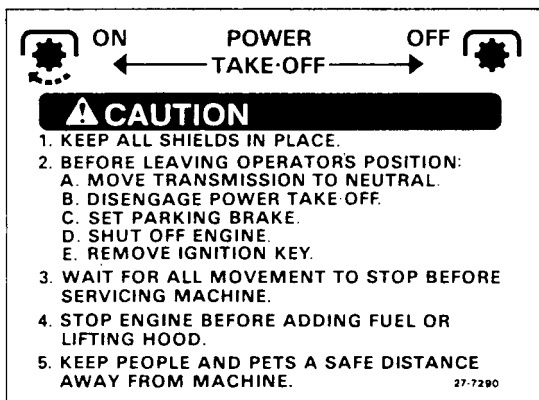

NEAR PTO LEVER
(Part No. 27-7290)

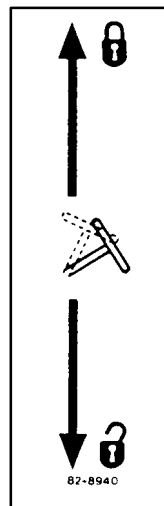

ON STEERING
COLUMN SUPPORT
(Part No. 82-8940)

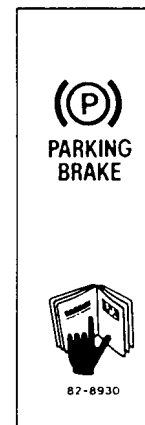

ON STEERING
COLUMN SUPPORT
(Part No. 82-8930)

SAFETY AND INSTRUCTION DECALS

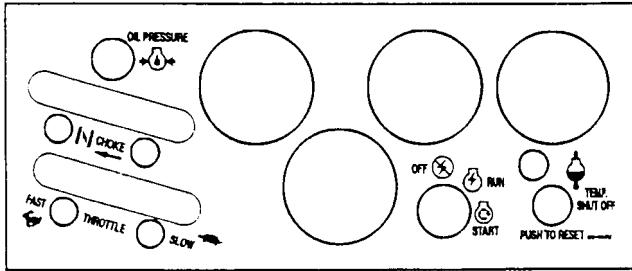

ON CONTROL PANEL
(Part No. 85-7470)

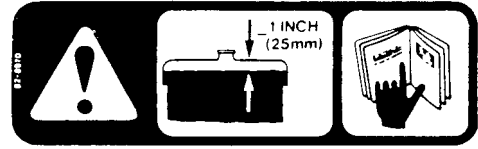

UNDER HOOD ABOVE RADIATOR CAP
(Part No. 82-8970)

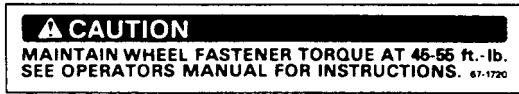

ON FRAME NEAR FRONT WHEELS
(Part No. 67-1720)

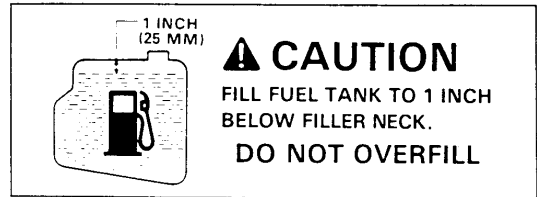

NEAR FUEL TANK CAP
(Part No. 27-7310)

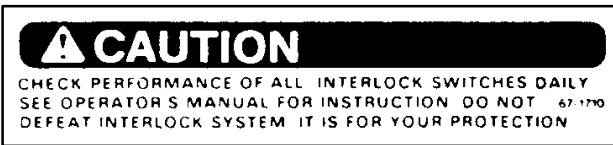

NEAR TOOL BOX COVER
(Part No. 67-1710)

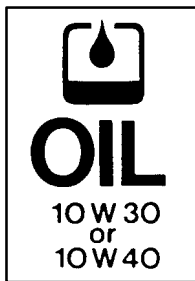

FRONT BULKHEAD
(Part No. 53-4430)



NEAR FUEL TANK
(Part No. 53-4420)

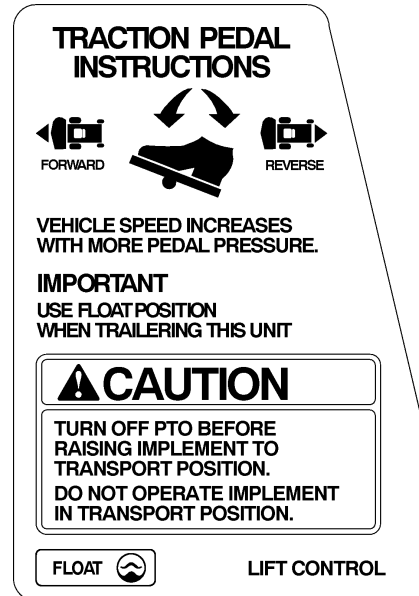

FLOAT **LIFT CONTROL**

STARTING INSTRUCTIONS (SEE OPERATORS MANUAL)

1. DISENGAGE POWER TAKE-OFF (PTO)
2. PLACE TRACTION DRIVE PEDAL IN NEUTRAL POSITION.
3. DEPRESS BRAKE PEDAL.
4. FOR DIESEL ENGINE UNITS:
 - A. SET THROTTLE CONTROL - FULL OPEN.
 - B. PUSH GLOW PLUG SWITCH TO ON POSITION AND PREHEAT UNTIL THE GLOW PLUG INDICATOR TURNS RED HOT AND HOLD WHILE STARTING.
4. FOR GAS ENGINE UNITS:
 - A. SET CHOKE AND THROTTLE CONTROLS AS REQUIRED.
5. TURN KEY TO START POSITION. RELEASE TO RUN POSITION AFTER STARTING. TO STOP, TURN KEY TO OFF POSITION AND REMOVE KEY.

IMPORTANT:
ENGINE WILL SHUT OFF AUTOMATICALLY DUE TO HIGH ENGINE TEMPERATURE. WHEN THIS HAPPENS:

1. ALLOW ENGINE TO COOL.
2. CLEAN DEBRIS FROM FRONT OF RADIATOR.
3. CHECK COOLANT LEVEL.
4. DEPRESS HIGH TEMPERATURE RESET ON DASH.
5. RESTART ACCORDING TO STARTING INSTRUCTIONS.

CAUTION
COOLANT UNDER PRESSURE. USE CAUTION WHEN REMOVING RADIATOR CAP TO PREVENT BURNS.

CAUTION
READ AND UNDERSTAND OPERATOR'S MANUAL BEFORE OPERATING THIS MACHINE. REPLACEMENT MANUAL AVAILABLE BY SENDING COMPLETE MODEL NUMBER TO: THE TORO CO., 8111 LYNDALE AVE. S., BLOOMINGTON, MN 55420-1196. 62-7802

ON BATTERY COVER
(Part No. 92-7802)

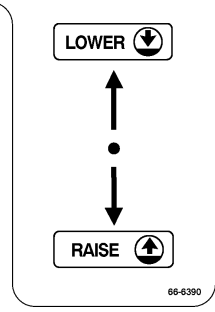

NEAR LIFT LEVER
(Part No. 66-6390)

SPECIFICATIONS

Engine: Ford, 4 cycle, 4-cylinder, overhead valve, liquid cooled gas engine with centrifugal water pump. Ford rates engine @ 45 hp (De-rated to 24 hp). Mechanically governed to a maximum speed of 3200 ± 100 rpm. 67 cu. in. (1100 cc) displacement. Distributor less electronic ignition. 3.5 quart (3.25 liter) oil capacity; replaceable oil filter. Forged connecting rods, cast iron cylinder head and block. Mechanical fuel pump. Spark arrestor muffler is standard.

Air Cleaner: Heavy duty, remote mounted.

Cooling System: Radiator has tube and fin construction with hydraulic oil cooler in lower tank. Capacity of cooling system is approximately 6 quarts (5.7 l) of a 50% mixture of permanent, ethylene glycol anti-freeze and water. Radiator is equipped with a 1 psi (90 kPa) pressure cap and engine has a 195° F thermostat.

Electrical: The 12 volt battery has 42 plates and is rated at 45 ampere hours. A 55 amp alternator with integral regulator is standard.

Fuel Tank: Capacity is approximately 6-1/2 gal. (25 L) of lead-free gasoline.

Front Axle: The heavy Duty Dana GT 20 axle has reduction of 20.9:1. Axle has automotive type differential, bevel gear pinion and ring gear with spur gear reduction from transmission. All axle components are mounted in tapered roller bearings.

Transmission: Sundstrand in-line hydrostatic transmission is mounted directly to the front axle and driven by flexible drive couplings. Operating pressure is 500 to 3000 psi (3447 to 20685 kPa) and normal charge pressure is 70 to 150 psi (453 to 1034 kPa). Implement relief valve setting is 700 to 900 psi (4826 to 6205 kPa.). Displacement is 0.913 cubic inch (15 cm³) per revolution, and transmission is controlled by foot-actuated pedal. Front axle is the hydraulic fluid reservoir, and its capacity is 5 quarts (4.7 L) of SAE 10W-30 or 10W-40 engine oil. The 25 micron hydraulic oil filter is a screw on replaceable type. For replacement filters, order Toro part number 23-9740.

Ground Speed: Speed is infinitely variable from 0 to 9.5 mph (0 to 15 km/hr) forward or reverse @ 3200 engine rpm.

Tires: Two rear tires are 16 x 6.50-8, 4-ply, rating rib, on demountable, drop center wheels. The two front tires are 23 x 8.50-12, extra traction tread, 4-ply rating, on demountable, drop center wheels. Recommended air pressure for both the front and rear tires is 21 psi (145 kPa).

Brakes: Brakes controlled by 3 pedals. Two are for steering assist. Each are individually controlled by left foot. Third pedal operates both brakes and is controlled by either foot. Parking brake latch provided for third pedal. Pedals are connected to brakes by multi-stranded cable and conduit.

Steering: The 15 inch (38 cm) steering wheel is mounted on a steering valve consisting of a control valve and metering section which regulates pressure and meters flow to the steering cylinder. Minimum turning radius is 18" from center of turn to closest side of drive wheel; however, zero turning radius results when individual wheel brakes are used. Steering wheel adjustable fore and aft for operator comfort.

Main Frame: Frame is welded, formed 11 ga. steel, reinforced with square and rectangular tubing.

Instrument Panel and Controls: Ammeter, hour-meter, fuel gauge, ignition switch, coolant temperature switch/gauge to prevent overheating, oil pressure warning light, choke and throttle control are on instrument panel. Hand operated PTO lever is located to right of the seat. Foot pedal control for transmission operation at right of steering column.

PTO Drive: Shaft is driven by a tight-slack double "A" section, torque team V-belt directly from output shaft of engine. Shaft is clutched by pivoting the shaft support with a spring loaded, over center, hand operated lever. PTO speed—1810 rpm @ 3200 rpm engine speed. Connection to implement is with high quality, needle bearing universal joint with slip joint.

Implement Lift: Cutting unit or implement is lifted by hydraulic cylinder that has 2-1/2 in. (64 mm) bore and 3-1/4 in. (82 mm) stroke.

DIMENSIONS AND WEIGHTS (approx.)

Width	46" (117 cm)
	(measured from outside of front tires)
w/30722 SD Cutting Unit	85.5" (217 cm)
w/30710 RD Cutting Unit	76.5" (194 cm)
w/Guardian® 72" Recycler® Cutting Unit	76.5" (194 cm)
Length	91" (231 cm)
w/30722 SD Cutting Unit	112" (285 cm)
w/30710 RD Cutting Unit	115" (292 cm)
w/Guardian® 72" Recycler® Cutting Unit	117.5" (298 cm)
	(2 rear weights included)
Height	50" (127 cm)
Dry Weight	1,300 lbs. (590 kg)
w/30722 SD Cutting Unit	1,700 lbs. (771 kg)
w/30710 RD Cutting Unit	1,715 lbs. (778 kg)
w/Guardian® 72" Recycler® Cutting Unit	1,765 lbs. (800 kg)
Wheel Base	49" (124 cm)

SPECIFICATIONS

OPTIONAL EQUIPMENT:

Cutting Unit, Model No. 30722 (L.H. Side Discharge)

Cutting Unit, Model No. 30710 (Rear Discharge)

Cutting Unit, Model No. 30716 (Guardian 72" Recycler)

2760 Flail Mower, Model No. 44590

Cushion Seat, Model No. 30708

Deluxe Suspension Seat Kit, Model No. 30772
(requires Model No. 30709)

Seat Adapter Kit, Model No. 30709

Armrest Kit, Model No. 30707 (For Model No. 30708 &
30772)

Seat Weight Kit, Part No. 92-1181

Leaf Mulcher Kit, Model No. 30732 (for Model 30721)

Leaf Mulcher Kit, Model No. 30733 (for Model 30722)

Rear Baffle Kit, Part No. 51-1460 (for Model
30721 only)

Pneumatic Wheel & Tire Assembly, Part No. 12-1509
(2 required per cutting unit)

10" Foam Filled Tire Assembly, Part No. 93-5973
(2 required per cutting unit)

High Lift Blade, Part No. 23-2410 (for Model 30722
only)

Speed Control Kit, Model No. 30677

Tire Chains (Front), Part No. 11-0390 (set of 2)

Wheel Weight Kit, Part No. 11-0440 (set of 2)

Rear Weight Kit, Part No. 24-5780 (set of 2)

Rear Weight Kit, Part No. 24-5790 (Qty. 1)

4-Ply Wide Tire w/ Rim, 23 x 10.5 x 12 , Part No.
62-7020 (2 required; will not fit with Model No. 30710)

Jack Pad Kit, Part No. 76-0900

48 in. V-Plow, Model No. 30750 (requires Model No.
30757)

V-Plow Mounting Kit, Model No. 30757 (w/o tire
chains)

Debris Blower 2670, Model No. 44524 (w/o kit)

Debris Blower 2670 Kit, Model No. 44535

Aeroseeder 82, Model No. 44815

Aerator 75, Model No. 44890

Plug Pulverizer 2560, Model No. 44892

Snow Blower 150, Model No. 44910

LOOSE PARTS

Note: Use this chart as a checklist to ensure all parts necessary for assembly have been shipped. If any of these parts are missing, total set-up cannot be completed.

DESCRIPTION	QTY.	USE
Steering Wheel Foam Seal Nut Screw Cap	1 1 1 1 1	Install Steering Wheel
Manual Tube (shipped in tool box) R-Clamp	1 2	Install on right underside of seat
Ball Joint R.H. (Shipped in tool box)	1	Install Ball Joint (implement installation) and Connect Lift Cylinder.
Operator's Manual (Traction Unit) Parts Catalog Engine Dealer Listing	2 1 1	Read before operating machine
Registration Card	1	Affixed to machine.
Hydraulic Oil Filter	1	Change after 10 hours

Specifications and design subject to change without notice.

SET-UP INSTRUCTIONS

INSTALL STEERING WHEEL

1. Remove jam nut from steering shaft. Slide foam seal and steering wheel onto steering shaft.
2. Secure steering wheel to shaft with jam nut and tighten it to 10–15 ft-lb.
3. Install cap to steering wheel with screw.

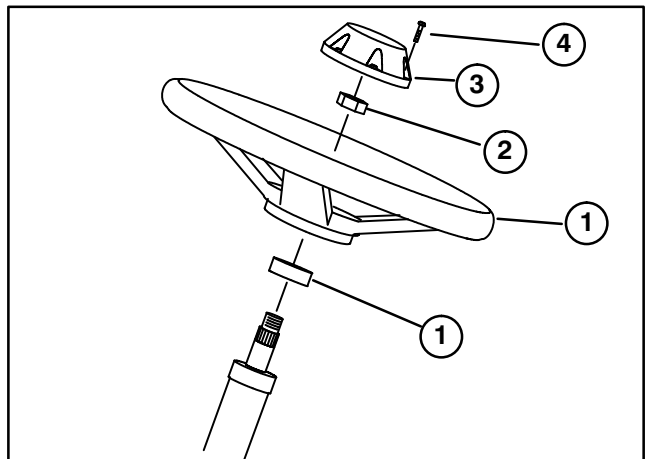

Figure 1

- | | |
|-------------------|--------------|
| 1. Steering Wheel | 4. Screw |
| 2. Jam Nut | 5. Foam Seal |
| 3. Cap | |

SET-UP INSTRUCTIONS

REMOVE BATTERY FROM CHASSIS

1. Release the two latches holding instrument cover in place. Carefully remove instrument cover to expose the battery.
2. Remove two wing nuts and hold down strap that secures battery (Fig. 2). Lift battery out of chassis. Keep wing nuts and hold down strap in safe place for later use.
3. Activate and charge battery, refer to Activate and Charge Battery.

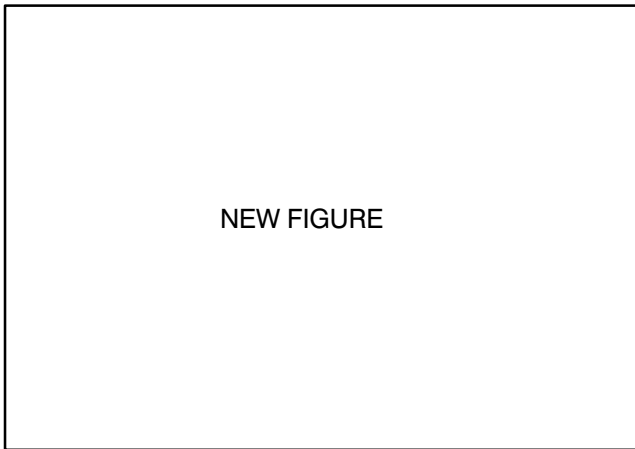

NEW FIGURE

Figure 2

- | | |
|--------------------|----------------------|
| 1. Wing nuts | 3. Positive terminal |
| 2. Hold down strap | 4. Negative terminal |

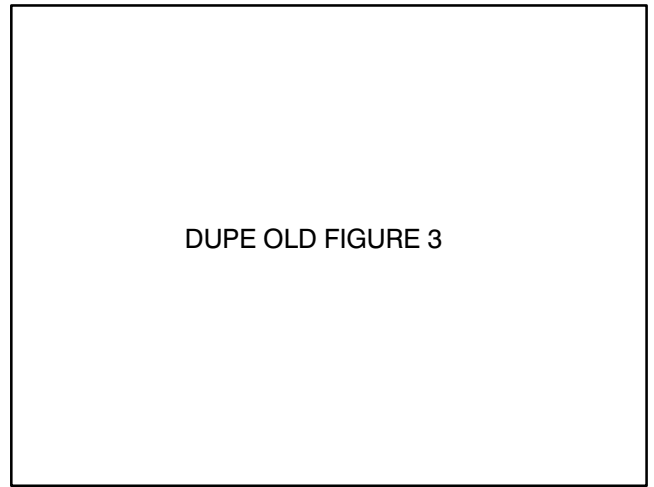

DUPE OLD FIGURE 3

Figure 3

- | | |
|-------------------------|-----------|
| 1. Seat Switch | 3. Spring |
| 2. Seat Support Bracket | 4. Pin |

5. Loosely secure (2) R-clamps to right side of seat bottom with (2) capscrews and flatwashers supplied in kit (Fig. 4). Install manual tube into R-clamps and tighten capscrews (Fig. 4).

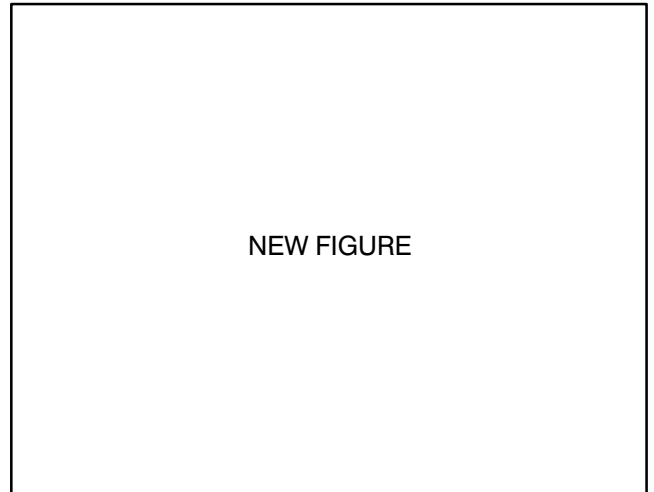

NEW FIGURE

Figure 4

1. R-clamps
2. Seat support
3. Manual tube

INSTALLING SEAT

The Groundsmaster 345 is shipped without the seat assembly. Either optional Seat Kit, Model No. 30708 or 30772 must be installed.

Seat Kit, Model No. 30708, Standard Seat

CAUTION: Spring under tension. use caution installing spring and pin.

1. Insert pin part way into hole in top of seat support bracket on machine (Fig. 3).
2. Slide spring up onto pin while pushing down on pin.
3. Pry top of spring down and insert roll pin through pin.
4. Check operation of pin.

6. Mount seat pivot bracket to frame with (2) flange screws supplied in kit (Fig. 5).

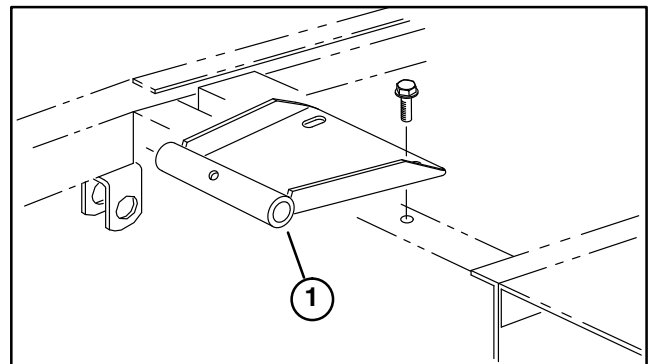

Figure 5

1. Seat Pivot Bracket

SET-UP INSTRUCTIONS

7. Mount seat and seat support to seat pivot bracket with pivot shaft and roll pin (Fig. 6).

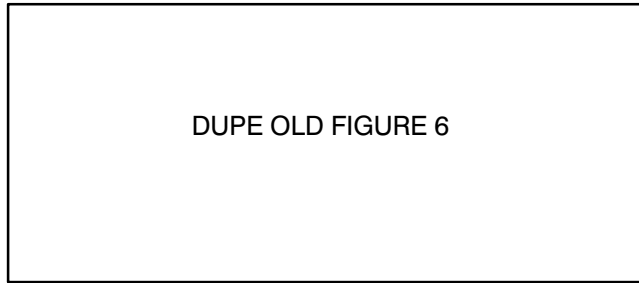

Figure 6

1. Pivot shaft
2. Roll pin

8. Hold seat up with seat support rod (Fig. 7).

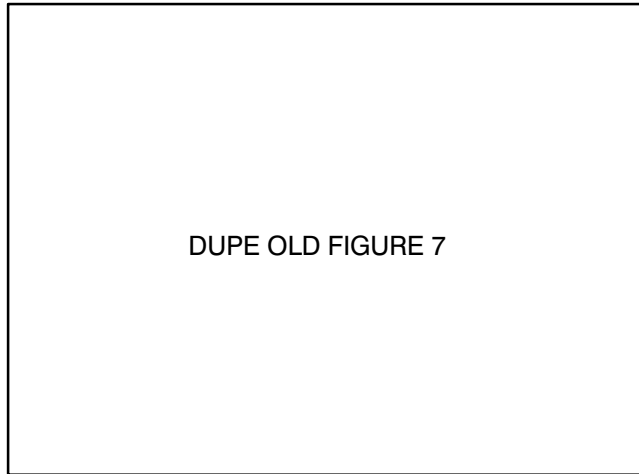

Figure 7

1. Seat Support Rod

Seat Kit, Model No. 30772, Deluxe Seat with Model 30709 Seat Adapter Kit:

CAUTION: Spring under tension. use caution installing spring and pin.

1. Insert pin part way into hole in top of seat support bracket on machine (Fig. 3).
2. Slide spring up onto pin while pushing down on pin.
3. Pry top of spring down and insert roll pin through pin.
4. Check operation of pin.
5. Mount seat suspension assembly to (4) capscrews on seat bottom and secure with (4) lockwashers, flatwashers and nuts (Fig. 8).
6. Loosely secure (2) R-clamps to right side of seat bottom with (2) capscrews and flatwashers supplied in kit (Fig. 8). Install manual tube into R-clamps and tighten capscrews (Fig. 8).
7. Mount seat support over four threaded studs at the bottom of seat suspension assembly and secure in place with lockwashers and nuts (Fig. 8).

Note: When mounting seat suspension, use forward set of mounting holes for a shorter operator, as shown in figure 8, or rear set for a taller operator.

8. Mount seat pivot bracket to frame with (2) flange screws supplied in kit (Fig. 5)

9. Mount seat and seat support to seat pivot bracket with pivot shaft and roll pin (Fig. 6).

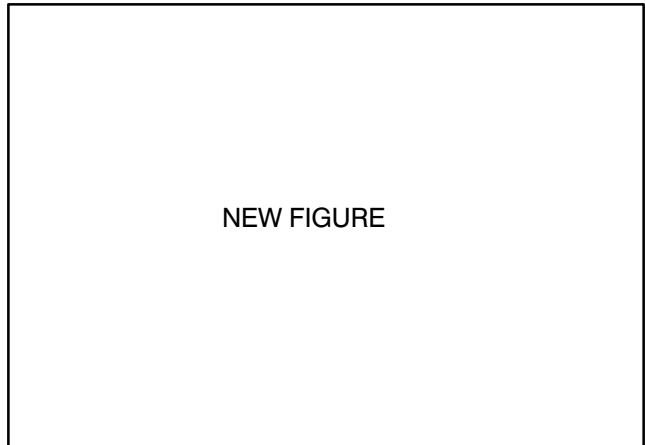

Figure 8

1. Seat suspension assembly
2. R-clamps
3. Manual tube
4. Seat support

10. Hold seat up with seat support rod (Fig. 7).

INSTALL OPTIONAL SEAT WEIGHT KIT

The optional weight kit is beneficial when mower operator is light weight, less than 150 lbs. or short in stature, less than 5' 4" tall.

IMPORTANT: Weight kit to be used only with seat adapter kit, Model 30709. Use of weight kit with any other seats may affect interlock system function.

1. Mount weight assembly to rear holes in seat support with (2) 5/16-18 x 2-1/4" lg capscrews and locknuts (Fig. 9).

IMPORTANT: Make sure seat suspension is mounted in front set of holes in seat support to insure the seat can be positioned forward enough to provide comfortable operation and control of the mower.

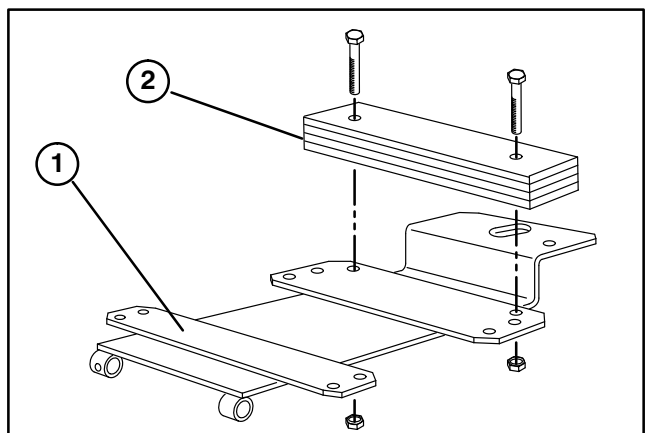

Figure 9

1. Seat support
2. Seat weight

SET-UP INSTRUCTIONS

PUSH TRACTION UNIT OFF PALLET

1. Reach in and rotate by-pass valve on transmission (Fig. 10) counterclockwise 1/2 to 1 turn. Opening the valve opens an internal passage in the pump, thereby bypassing transmission oil. Because fluid is by-passed, the machine can be pushed without damaging the transmission.

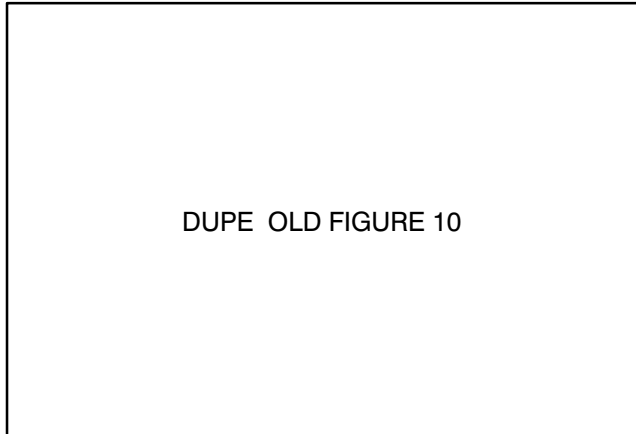

Figure 10

1. By-pass valve

2. Lift machine over shipping braces and push machine off pallet.

3. Close by-pass valve by rotating it clockwise until it is securely seated. Do not exceed 5 to 8 ft-lb (7 to 11 N-m). Do not start engine when valve is open.

ACTIVATE AND CHARGE BATTERY

1. Since battery is not filled with electrolyte or charged, bulk electrolyte with 1.260 specific gravity must be purchased from a local battery supply outlet.

	CAUTION
<p>Wear safety goggles and rubber gloves when working with electrolyte, and charge the battery in a well-ventilated place so gases produced while charging can dissipate. Since the gases are explosive, keep open flame and electrical sparks away from the battery. Do not smoke. Nausea may result if the gases are inhaled. Unplug charger from electrical outlet before connecting to or disconnecting charger leads from battery posts.</p>	

2. Remove filler caps from battery and slowly fill each cell until electrolyte is just above the plates. Install filler caps.

3. Connect a 3 to 4 amp battery charger to the battery posts. Charge the battery at a rate of 3 to 4 amperes for 4 to 8 hours.

4. When battery is fully charged, disconnect charger from electrical outlet and battery posts.

5. Remove filler caps and slowly add electrolyte to each cell until level is up to fill ring. Install fill caps.

INSTALL BATTERY IN CHASSIS

1. Install battery and secure with hold down strap and wing nuts (Fig. 2). Remove tape over ends of each cable.

2. Slide the red, positive battery cable (Fig. 2) onto positive battery post and tighten nut securely.

3. Slide the black, negative battery cable (Fig. 2) onto negative battery post and tighten nut securely.

4. Coat both battery connections with either Grafo 112X (skin-over) grease, Toro Part No. 505-47, petroleum jelly or light grease to prevent corrosion and slide rubber boot over positive terminal (Fig. 2).

5. Install the instrument cover and lock the two latches.

6. Disengage seat support rod and pivot downward. Pivot seat down and push lynch pin through seat latch stud. Flip wire end of pin over latch stud (Fig. 11).

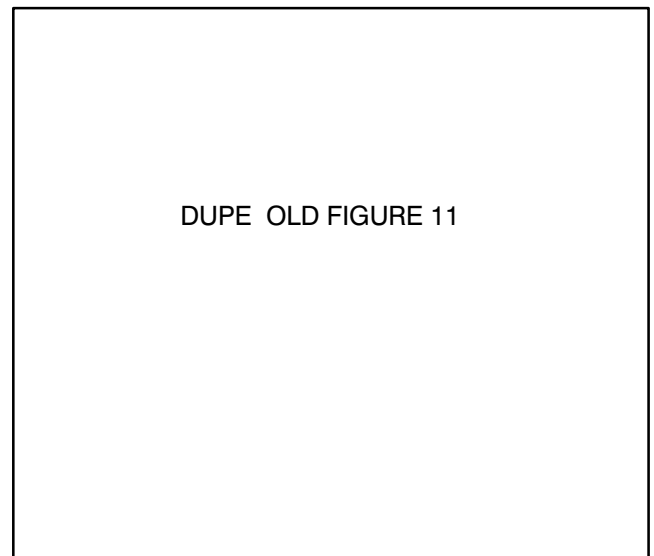

Figure 11

1. Lynch pin

INSTALL BALL JOINT AND CONNECT LIFT CYLINDER

Note: Ball joints are not required for all implements; refer to implement operator's manual for requirements.

1. Thread jam nut fully onto right hand ball joint.

2. Screw ball joint into right hand push arm until center of ball joint is 2-3/8 inches (60 mm) away from front of push arm (Fig.12). Do not tighten jam nut.

SET-UP INSTRUCTIONS



WARNING

Since push arms are spring-loaded, a helper is required to push the arms down during installation of the ball joints or other implements. Sudden release of the push arms could cause injury.

DUPE OLD FIGURE 12

Figure 12

1. Jam nut
2. Ball joint mount
3. 2-3/8 in. (60 mm)
4. Right hand push arm

4. Have a helper push down on the left push arm. Then insert a 2 x 4 in. (51 x 102 mm) block of wood between the frame and top of the push arm (Fig. 12). Screw ball joint into left hand push arm until center of ball joint is 2-3/8 inches (60 mm) away from front of push arm (Fig.13). Do not tighten jam nut.

DUPE OLD FIGURE 13

Figure 13

1. Jam nut
2. 2 x 4 in. (51 x 102 mm) block
3. Left hand push arm
4. Ball joint mount
5. 2-3/8 in. (60 mm)

5. Carefully remove 2 x 4 in. (51 x 102 mm) block of wood from between frame and push arm.

6. Remove spring pin from cylinder pin and slide cylinder pin out of cylinder.

7. Raise front of lift arm until hole in movable end of cylinder lines up with holes in lift arm brackets. Use caution as lift arm is spring-loaded. Hold parts together with cylinder pin, spring pin, and cotter pin. Cotter pin must be to the outside.

8. Install implement; refer to implement Operator's Manual for proper installation procedures.

CHECK TIRE PRESSURE

The tires are over-inflated for shipping. Therefore, release some of the air to reduce the pressure. Correct air pressure in the front and rear tires is 21 psi (145 kPa).

CHECK TORQUE OF FRONT WHEEL NUTS



WARNING

Tighten front wheel nuts to 45-55 ft-lb (61-75 N·m) after 1-4 hours of operation and again after 10 hours of operation and every 250 hours thereafter. Failure to maintain proper torque could result in failure or loss of wheel and may result in personal injury.

GREASE TRACTION UNIT

Before the machine is operated, it must be greased to assure proper operating characteristics; refer to Lubrication Maintenance. Failure to grease the machine will result in premature failure of critical parts.

Note: After set-up has been completed, remove protective edging (used for shipping) from fenders.

SET – UP INSTRUCTIONS

INSTALL REAR WEIGHT

To comply with ANSI/OPEI B71.4–1990 Standard, rear weight must be added to rear of traction unit. Use chart below to determine weight requirements. Order parts from your local Authorized Toro Distributor.

Cutting Unit Description	Rear Weight Required	Weight Part Number	Weight Description	Qty.
72" Side Discharge (Model 30722) or 72" Rear Discharge (Model 30710) or Guardian 72" Recycler (Model 30716) or 2760 Flail Mower (Model 44590)	105 lb.	24–5780 & 24–5790	Rear Weight Kit (includes two 35 lb. weights and mounting hardware) & Rear Weight Kit (includes one 35 lb. weight and mounting hardware)	1 1
Triflex 88" (Model 30715)	140 lb.	24–5780	Rear Weight Kit (includes two 35 lb. weights and mounting hardware)	2

BEFORE OPERATING

CHECK CRANKCASE OIL

The engine is shipped with 3.5 quarts (3.25 L) of oil in the crankcase. However, level of oil must be checked before and after the engine is first started.

1. Position the machine on a level surface.
2. Disengage hood latch and open the hood.
3. Slide bottom of hood prop out of retaining bracket (Fig. 14). Lower hood prop, pivot upward, then downward to prop up hood.

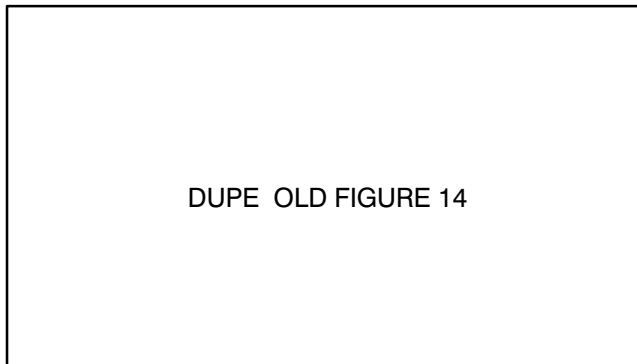

Figure 14
1. Hood Prop

3. Remove dipstick and wipe it with a clean rag (Fig. 15). Push dipstick down into the tube and ensure it is fully seated. Pull dipstick out of the tube and check level of oil. If oil level is low, remove filler cap (Fig. 15) and add enough oil to raise level to top notch on dipstick. DO NOT OVERFILL.

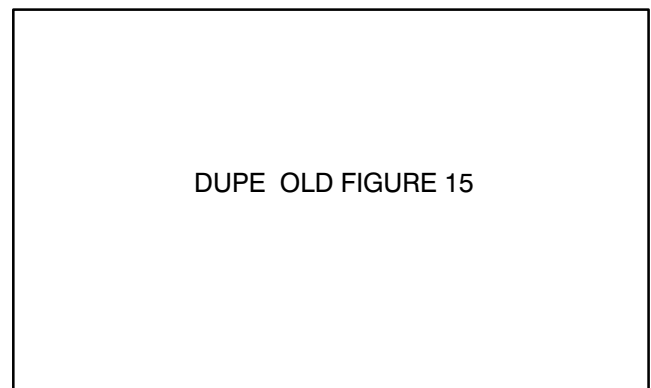

Figure 15
1. Oil dipstick
2. Filler cap

BEFORE OPERATING

4. The engine uses any high-quality detergent oil having the American Petroleum Institute—API—“service classification” SG, SG/CC or SG/CD. Oil viscosity-weight must be selected according to ambient temperature. Temperature/viscosity recommendations are:

SINGLE VISCOSITY OILS

Outside Temperature

-10°F to +60°F	SAE 10W
+10°F to +90°F	SAE 20W-20
Above +32°F	SAE 30
Above +50°F	SAE 40

MULTI- VISCOSITY OILS

Outside Temperature

Below +60°F	SAE 5W-30
-10°F to +90°F	SAE 10W-20
Above -10°F	SAE 10W-40 or 10W50
Above +10°F	SAE 20W-40 or 20W50

IMPORTANT: Check level of oil after every 5 hours of operation or daily. Change oil and filter initially after 50 hours and every 100 hours thereafter. Change oil and filter more frequently when engine is operated in extremely dusty or dirty conditions.

5. Install dipstick into tube.

FILL FUEL TANK WITH GASOLINE

THE TORO COMPANY STRONGLY RECOMMENDS THE USE OF FRESH, CLEAN, **UNLEADED** REGULAR GRADE GASOLINE IN TORO GASOLINE POWERED PRODUCTS. UNLEADED GASOLINE BURNS CLEANER, EXTENDS ENGINE LIFE, AND PROMOTES GOOD STARTING BY REDUCING THE BUILD-UP OF COMBUSTION CHAMBER DEPOSITS. LEADED GASOLINE CAN BE USED IF UNLEADED IS NOT AVAILABLE.

NOTE: NEVER USE METHANOL, GASOLINE CONTAINING METHANOL, GASOLINE CONTAINING MORE THAN 10% ETHANOL, GASOLINE ADDITIVES, OR WHITE GAS BECAUSE ENGINE FUEL SYSTEM DAMAGE COULD RESULT.

1. Tip seat forward and prop it with the support rod so it cannot fall accidentally (Fig.16). Using a clean rag, clean area around fuel tank cap.

2. Remove cap from the fuel tank and fill the 8-1/2 gallon (30 L) tank to within 1 inch (25 mm) from the top with gasoline. Install fuel tank cap tightly after filling tank.

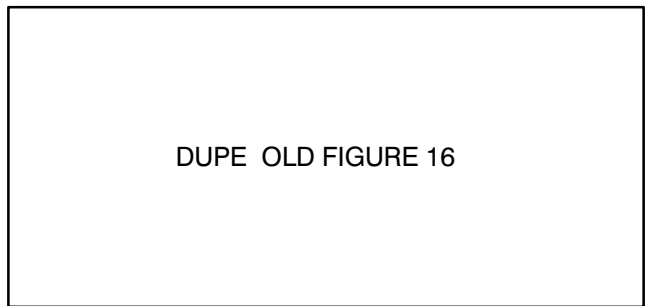



Figure 16

1. Fuel cap

**DANGER**

Because gasoline is flammable, caution must be used when storing or handling it. Do not fill fuel tank while engine is running, hot, or when machine is in an enclosed area. Vapors may build up and be ignited by a spark or flame source many feet away. **DO NOT SMOKE** while filling the fuel tank to prevent the possibility of an explosion. Always fill fuel tank outside and wipe up any spilled gasoline before starting engine. Use a funnel or spout to prevent spilling gasoline and fill tank to about 1 inch (25 mm) below the filler neck. Store gasoline in a clean, safety-approved container and keep the cap in place on the container. Keep gasoline in a cool, well-ventilated place, never in an enclosed area such as a hot storage shed. To assure volatility, do not buy more than a 6 month supply. Gasoline is a fuel for internal combustion engines; therefore, do not use it for any other purpose. Since many children like the smell of gas, keep it out of their reach because the fumes are explosive and dangerous to inhale.

CHECK COOLING SYSTEM

Clean debris off screen and front of radiator daily, hourly if conditions are extremely dusty and dirty; refer to Cleaning Radiator and Screen.

The cooling system is filled with a 50/50 solution of water and permanent ethylene glycol anti-freeze. Check level of coolant at beginning of each day before starting the engine. Capacity of cooling system is approximately 6 quarts (5.7 L).

1. Carefully remove radiator cap. Coolant is pressurized and may be hot if engine has been running.

2. Check level of coolant in radiator. Level of coolant must be above the core and about 1 inch (25 mm) below bottom of filler neck.

3. If coolant level is low, replenish the system. **DO NOT OVERFILL.**

4. Install radiator cap.

BEFORE OPERATING

CHECK HYDRAULIC SYSTEM OIL

The hydraulic system is designed to operate on any high-quality detergent oil having the American Petroleum Institute—API—“service classification” SE/SF. Oil viscosity—weight—must be selected according to anticipated ambient temperature. Temperature / viscosity recommendations are:

Expected Ambient Temperature	Recommended Viscosity and Type
(Extreme) over 90°F	SAE 30, Type SE/SF engine oil.
(Normal) 40-100°F	SAE 10W-30 or 10W-40, Type SE/SF engine oil.
(Cool—Spring/Fall) 30-50°F	SAE 5W-30, Type SE/SF engine oil.
(Winter) Below 30°F	Type “F” or “FA” ATF Automatic Transmission Fluid.

Note: Do not mix engine oil and automatic transmission fluid or hydraulic system component damage may result. When changing fluids, also change transmission filter. **DO NOT USE DEXRON II ATF.**

Note: Fluid to operate the power steering is supplied by the hydraulic system transmission charge pump. Cold weather start-up may result in “stiff” operation of the steering until the hydraulic system has warmed up. Using proper weight hydraulic oil in system minimizes this condition.

The front axle housing acts as the reservoir for the system. The transmission and axle housing are shipped from the factory with approximately 5 quarts (4.7 L) of SAE 10W-30 engine oil. However, check level

of transmission oil before engine is first started and daily thereafter.

1. Position machine on a level surface, raise the implement, and stop the engine.
2. Unscrew dipstick cap (Fig. 17) from the filler neck and wipe it with a clean rag. Screw dipstick cap fingertight onto filler neck. Unscrew the dipstick and check level of oil. If level is not within 1/2 inch (13 mm) from the groove in the dipstick, add enough oil to raise level to groove mark. **DO NOT OVERFILL** by more than 1/2 inch (13 mm) above groove.

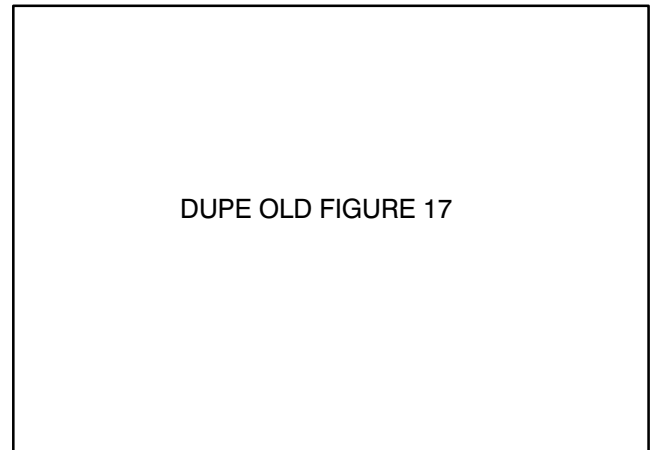

Figure 17

1. Dipstick cap
2. Groove

IMPORTANT: When adding oil to the hydraulic system, use a funnel with a fine wire screen—200 mesh—and ensure funnel and oil are immaculately clean. This procedure prevents accidental contamination of the hydraulic system.

3. Screw dipstick filler cap finger-tight onto filler neck. It is not necessary to tighten cap with a wrench.
4. Lower the implement.

CONTROLS

Traction Pedal (Fig.18)—Traction pedal has two functions; one is to make the machine move forward, the other is to make it move backward. Using the heel and toe of the right foot, depress top of pedal to move forward and bottom of pedal to move backward. Ground speed is proportionate to how far pedal is depressed. For maximum ground speed with no load, traction pedal must be fully depressed while throttle is in FAST position. Maximum speed forward is approximately 9.5 mph (15 km/hr). To get maximum power under heavy load or when ascending a hill, have throttle in FAST position while depressing traction pedal slightly to keep engine rpm high. When engine rpm begins to decrease, release traction pedal slightly to allow engine rpm to increase.

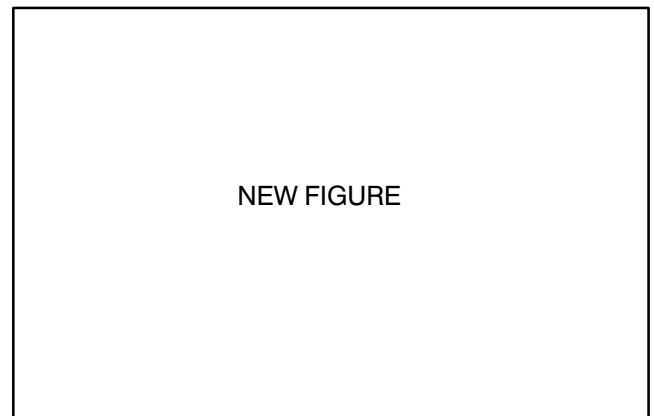

Figure 18

1. Traction pedal
2. Turn pedals
3. Brake pedal
4. Parking brake knob
5. Tilt Steering Control

CONTROLS



CAUTION

When foot is removed from the traction pedal, machine should stop; it must not creep in either direction. If machine does creep, do not operate until neutral assembly has been repaired and adjusted; refer to Adjusting Traction Drive for Neutral.

Turn Pedals (Fig. 18)—The left and right turn pedals are connected to the left and right front wheel brakes since both brakes work independently of each other. The brakes can be used to turn sharply or to increase traction if one wheel tends to slip while operating on a hillside. However, wet grass or soft turf could be damaged when brakes are used to turn.

Tilt Steering Control (Fig. 18)—Lever on right side of steering column. Pull lever rearward to adjust steering wheel to desired fore or aft operating position and push lever forward to lock adjustment.

Brake Pedal (Fig. 18)—Whenever the engine is shut off, the parking brake must be engaged to prevent accidental movement of the machine.

The hydrostatic transmission will not, at any time, act as a parking brake for the machine. To engage parking brake, push down fully on brake pedal and pull parking brake knob out; then release the pedal. To release parking brake, depress brake pedal until parking brake knob retracts. To stop quickly, remove right foot from traction pedal and depress the brake pedal. To permit straight stops, brake cables must be evenly adjusted.

Lift Lever (Fig. 19)—The hydraulic lift lever has three positions: FLOAT, TRANSPORT, and RAISE. To lower implement to the ground, move lift lever forward into notch, which is the FLOAT position. The FLOAT position is used for operation and also when machine is not in operation. To raise implement, pull lift lever backward to the RAISE position. After implement is raised, allow lift lever to move to the TRANSPORT position. Normally, implement should be raised when driving from one work area to another, except when descending steep slopes.



CAUTION

Never raise implement or cutting unit while blades or other components are rotating. The exposed, rotating blades are hazardous.

DUPE OLD FIGURE 19

Figure 19

1. Lift lever

PTO Lever (Fig. 20) – The PTO lever has two positions: ON (engage) and OFF (disengage). Slowly push PTO lever fully forward to ON position to start the implement or cutting unit blades. Slowly, pull lever backward to OFF position to stop implement operation. The only time PTO lever should be in the ON position is when implement or cutting unit is down in operating position.

NEW FIGURE

Figure 20

- | | |
|---------------------------|------------------------|
| 1. PTO lever | 6. Ammeter |
| 2. Choke | 7. Temp. gauge & reset |
| 3. Oil pressure indicator | 8. Throttle control |
| 4. Hour meter | 9. Fuel gauge |
| 5. Ignition switch | 10. Battery cover |

Hour Meter (Fig. 20) – The hour meter registers accumulated hours of engine operation. Use the hour meter to determine intervals for service maintenance and lubrication.

Fuel Gauge (Fig. 20) – Indicates quantity of fuel remaining in fuel tank.

Oil Pressure Warning Light (Fig. 20) – The oil pressure warning light glows and a buzzer sounds when oil pressure in engine drops below a safe level. If low oil pressure ever occurs, stop engine and determine the cause. Repair the damage before starting the engine again.

CONTROLS

Ammeter (Fig. 20) – Ammeter shows charge rate of the battery by the alternator. When engine is running, there usually is a slight charge, unless engine is idling slowly. Needle points to 0 when battery is fully charged. By contrast, alternator is not charging the battery when needle points to (-) negative side of ammeter. If this happens, repair the charging system to prevent discharge of the battery.

Temperature Switch/Gauge and Reset Button (Fig. 20) – The temperature switch/gauge registers the temperature of the coolant in the cooling system. If temperature of coolant gets too high the engine will shut off automatically. When this happens, rotate ignition key to OFF. Automatic shut-off of the engine usually results from debris on front of screen or radiator, which reduces air flow. After cleaning outside of screen and radiator or repairing some other damage, press the reset button and start the engine.

IMPORTANT: If the switch must be overridden because of an emergency, the engine can be started and will continue to run while reset button is held in.

Ignition Switch (Fig. 20) – The key switch, which is used to start and stop the engine, has three position: OFF, RUN, and START. Rotate key clockwise to the START position to engage starter motor. When engine starts, release key and it will move automatically to the ON position. To shut engine off, rotate key counterclockwise to the OFF position.

Choke (Fig. 20) – To start a cold engine, close carburetor choke by moving choke control fully forward. After engine starts, regulate choke to keep engine running smoothly. As soon as possible, open the choke by pulling it backward.

Throttle Control (Fig. 20) – Throttle is used to operate engine at various speeds. Moving throttle forward increases engine speed—FAST; backward decreases engine speed—SLOW. The throttle regulates the speed of the cutter blades or other implement components and, in conjunction with traction pedal, controls ground speed of the traction unit.

Electrical System Fuses (Fig. 21) – Two inline fuses—SFE 14 amp—are incorporated into the electrical system. Access to the fuses can be gained by removing the instrument panel cover.

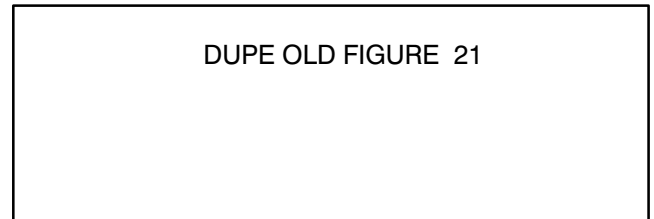

Figure 21

1. Location of SFE 14 amp fuses—(2)

Seat Adjusting Lever (Fig. 22) – To adjust standard seat, push lever backward and slide seat to the desired position. Release lever to lock seat in place.

The suspension seat may be adjusted forward or rearward by pulling out the lever at the left side of the seat, sliding the seat to the desired position, and releasing the lever. The weight adjustment knob may be adjusted for any operator's comfort.

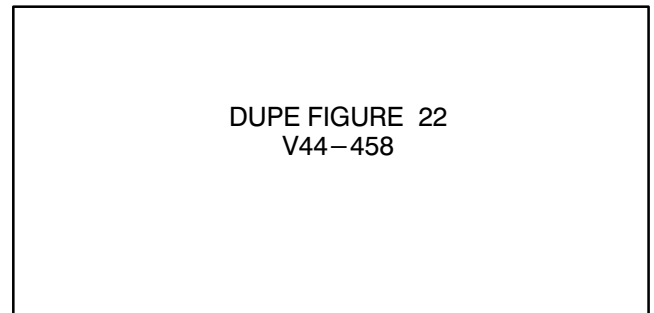

Figure 22

1. Seat adjusting lever

OPERATING INSTRUCTIONS

STARTING/STOPPING ENGINE

1. Ensure parking brake is set, PTO lever is in OFF position (Fig. 20), and lift lever is in TRANSPORT or FLOAT position (Fig. 19). Remove foot from traction pedal and insure it is in neutral.
2. Move throttle control (Fig. 20) to 1/4–1/3 open position.
3. To start engine, move choke lever (Fig. 20) fully forward.
4. Insert key into ignition switch (Fig. 20) and rotate it clockwise to START position. Hold key in START position for a few seconds to energize ignition system. Release key immediately when engine starts and regulate choke to keep engine running smoothly.

IMPORTANT: To prevent overheating the starter motor, do not engage starter longer than 15 seconds. After 15 seconds of continuous cranking, wait 10 to 15 seconds before engaging starter motor again. To prevent a short in the ignition system, use only one key in the switch. If keys are on a ring, one of the keys could contact pin on top of temperature gauge resulting in a short.

5. When engine is started for the first time, or after overhaul of the engine, transmission or axle, operate the machine in forward and reverse for one or two minutes. Also operate the lift lever and PTO lever to assure proper operation of all parts. Turn steering wheel to the left and right to check steering response. Then shut engine off and check for oil leaks, loose parts, and any other noticeable difficulties.



Shut engine off and wait for all moving parts to stop before checking for oil leaks, loose parts, or other difficulties.

6. To stop engine, move throttle control backward to 1/4–1/3 position, move PTO lever to OFF position and rotate ignition key to OFF. Remove key from switch to prevent accidental starting.

CHECKING INTERLOCK SWITCHES

The machine has interlock switches in the electrical system. These switches are designed to stop the engine when operator gets off the seat while either the PTO lever is engaged or traction pedal is depressed. However, operator may get off the seat while engine is running. Although engine will continue to run if PTO lever is disengaged and traction pedal is released, it is strongly recommended that the engine be stopped before dismounting from the seat.



Do not disconnect the interlock switches. Check operation of switches daily to assure interlock system is operating correctly. If a switch is malfunctioning, replace it before operating the machine. To ensure maximum safety, replace all switches after every two years or 1000 hours, whichever comes first.

To check operation of interlock switches:

1. Drive the machine slowly to a large, relatively open area. Lower cutting unit, stop the engine and apply parking brake.
2. Sit on seat. Move PTO lever to ON position. With the traction pedal in neutral position, try to start the engine. The engine should not crank. If the engine cranks, there is a malfunction in the interlock system that should be corrected before beginning operation.
3. Sit on seat. Move PTO lever to OFF and depress the traction pedal. Try to start the engine. The engine should not crank. If the engine cranks, there is a malfunction in the interlock system that should be corrected before beginning operation.



Do not operate machine without implement unless the PTO driveshaft is also removed.

4. Sit on seat and start the engine. Raise off the seat and move the PTO lever to ON. The engine should stop within 2-3 seconds. If the engine does not stop, there is a malfunction in the interlock system that should be corrected before beginning operation.

PUSHING OR TOWING TRACTION UNIT

In an emergency, the traction unit can be pushed or towed for a very short distance. However, Toro does not recommend this as standard procedure.

IMPORTANT: Do no push or tow the traction unit faster than 2 to 3 mph (3 to 4.8 km/hr) because transmission may be damaged. If traction unit must be moved a considerable distance, transport it on a truck or trailer. Whenever traction unit is pushed or towed, by-pass valve must be open.

1. Reach under traction unit and rotate by-pass valve (Fig. 23) 1/2 to 1 turn counterclockwise. Opening the valve opens an internal passage in the transmission, thereby by-passing transmission oil. Because fluid is by-passed, traction unit can be moved without damaging the transmission.

OPERATING INSTRUCTIONS

DUPE OLD FIGURE 23

Figure 23

1. By-pass valve

2. Before starting engine, close by-pass valve by rotating it clockwise until it is securely seated. Do not exceed 5 to 8 ft-lb (7-11 N·m). Do not start engine when valve is open.

IMPORTANT: Running the machine with by-pass valve open will cause the transmission to overheat.

OPERATING CHARACTERISTICS

Practice driving the GROUNDMASTER 345 because it has a hydrostatic transmission and its characteristics are different than many turf maintenance machines. Some points to consider when operating the traction unit, cutting unit, or other implement are the transmission, engine speed, load on the cutting blades or other implement components, and the importance of the brakes.

To maintain enough power for the traction unit and implement while operating, regulate traction pedal to keep engine rpm high and somewhat constant. A good rule to follow is: decrease ground speed as the load on the implement increases, and increase ground speed as the load decreases.

Therefore, allow traction pedal to move backward as engine rpm decrease, and depress pedal slowly as rpm increase. By comparison, when driving from one work area to another—with no load and cutting unit raised—have throttle in FAST position and depress traction pedal slowly but fully to attain maximum ground speed.

Another characteristic to consider is the operation of the turning pedals that are connected to the brakes. The brakes can be used to assist in turning the machine. However, use them carefully, especially on soft or wet grass because the turf may be torn accidentally. Another benefit of the turning brakes is to maintain traction. For example: in some slope conditions, the uphill wheel slips and loses traction. If this situation occurs, depress uphill turn pedal gradually and intermittently until the uphill wheel stops slipping, thus, increasing traction on the downhill wheel.

CAUTION: This product may exceed noise levels of 85 dB(A) at the operator position. Ear protectors are recommended, for prolonged exposure, to reduce the potential of permanent hearing damage.

The grass deflector(s) must always be installed and in lowest position on the side discharge cutting unit.



WARNING

This product is designed to drive objects into the ground where they lose energy quickly in grassy areas. However, when a person or pet appears suddenly in or near mowing area, STOP MOWING.

Careless operation, combined with terrain angle, ricochets, or improperly positioned safety guards can lead to thrown object injuries. Do not resume mowing until area is cleared.

Use extra care when operating machine on slopes. Always have seat pivot retaining pin installed. Drive slowly and avoid sharp turns on slopes to prevent roll overs. The cutting deck must be lowered when going downhill for steering control.

Before stopping the engine, disengage all controls and move throttle to 1/4 to 1/3 open. This reduces high engine rpm, noise, vibration and the possibility of backfiring of the engine. Turn key to OFF to stop engine.

DAILY MAINTENANCE CHECKLIST

Daily Maintenance: (duplicate this page for routine use)

Maintenance Check Item ▼	Daily Maintenance Check For Week Of _____						
	MON	TUES	WED	THURS	FRI	SAT	SUN
✓ Safety Interlock Operation							
✓ Grass Deflector in Down Position							
✓ Brake Operation							
✓ Fuel Level							
✓ Engine Oil Level							
✓ Cooling System Fluid Level							
✓ Dust Cup and Baffle (Air Filter)							
✓ Radiator & Screen for Debris							
✓ Unusual Engine Noises							
✓ Unusual Operating Noises							
✓ Transmission Oil Level							
✓ Hydraulic Hoses for Damage							
✓ Fluid Leaks							
✓ Tire Pressure							
✓ Instrument Operation							
✓ Condition of Blades							
Lubricate All Grease Fittings ¹							
Touch-up Damaged Paint							

¹= Immediately after every washing, regardless of the interval listed.

Notation for areas of concern: Inspection performed by _____

Item	Date	Information
1		
2		
3		
4		
5		
6		
7		
8		

Check proper section of Operator's Manual for fluid specifications

LUBRICATION MAINTENANCE

GREASING BEARINGS, BUSHINGS AND BRAKE CABLES

The traction unit must be lubricated regularly. If machine is operated under normal conditions, lubricate all bearings and bushings after every 50 hours of operation.

1. The traction unit bearings and bushings that must be lubricated are: PTO shaft and yokes (Fig. 24); lift arm pivots (Fig. 25); right and left push arm ball joints (Fig. 24); push arm pivot bushings (Fig. 26); PTO pivot housing blocks (Fig. 27); brake pivot bushings (Fig. 28); rear wheel spindle bushings, steering plate bushings, axle pin bushing, steering cylinder (2) (Fig. 29) and engine output shaft bearing (Fig. 30). Also apply grease to both brake cables at the drive wheel and brake pedal ends.

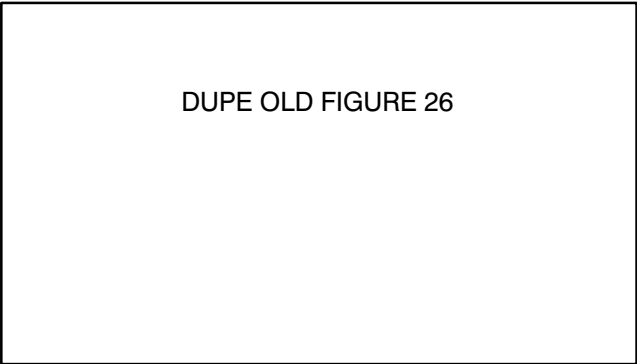

Figure 26

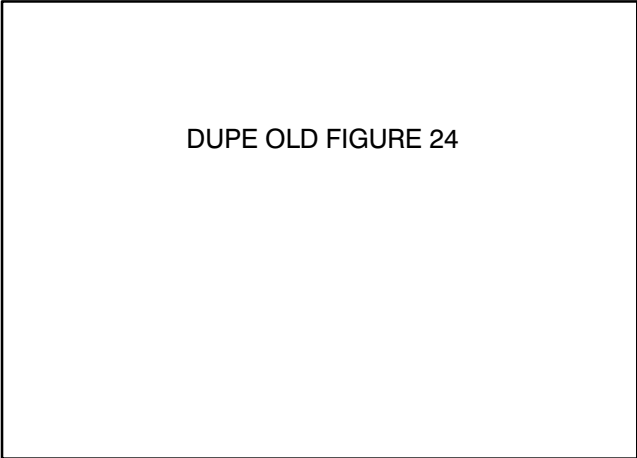

Figure 24

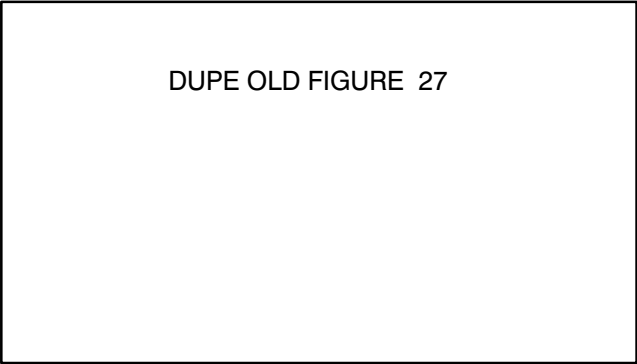

Figure 27

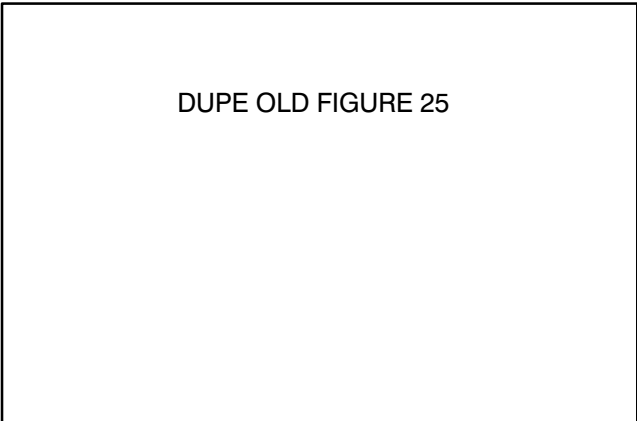

Figure 25

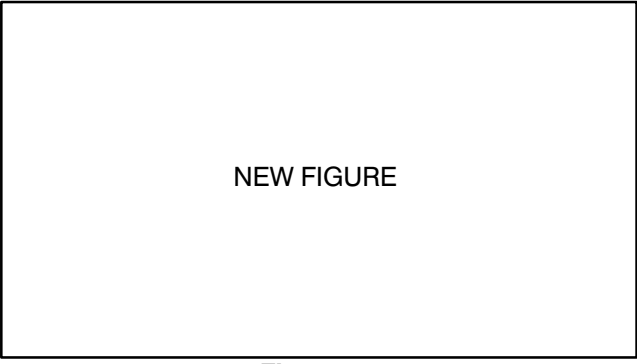

Figure 28

LUBRICATION MAINTENANCE

DUPE OLD FIGURE 29

Figure 29

DUPE OLD FIGURE 30

Figure 30

ELECTRICAL MAINTENANCE

REPLACING SEAT SWITCH

1. Remove instrument cover and disconnect negative battery cable from battery.
2. Pivot seat forward and secure with support rod to prevent it from falling accidentally and possibly causing injury.
3. Remove boot from button end of seat switch (Fig. 31). Retain boot for reinstallation. Separate switch wire connectors.

DUPE OLD FIGURE 31

Figure 31
1. Seat Switch

4. Remove top jam nut securing switch to mounting bracket and remove switch.
5. Install new seat switch to support bracket. Adjust switch height so it is 3/32" (2.4 mm) below top of spring pin. Tighten jam nuts to 75 in-lb. Reinstall boot to switch.

IMPORTANT: Switch threads will be damaged if jam nuts are over tightened.

6. Carefully release seat to its normally down position, but do not sit or apply pressure to the seat. There should be a slight gap between the switch and the seat plate.

7. Connect a continuity tester or ohm meter to switch connector. With seat in down position and no one on the seat, the switch circuit should not have any continuity. If there is continuity, recheck switch installation. If there is no continuity, proceed to next step.
8. Sit on the seat. The seat switch should have continuity. If there is no continuity, recheck switch installation. If there is no continuity, proceed to next step.
9. Push switch connectors together.
10. Connect battery cable and install instrument cover.

REPLACING PTO SWITCH

1. Remove instrument cover and disconnect negative battery cable from battery.
2. Move PTO lever forward to ON position.
3. Remove boot from button end of PTO switch (Fig. 32). Retain boot for reinstallation. Separate switch wire connectors.

DUPE OLD FIGURE 32

Figure 32
1. PTO Switch

4. Remove front jam nut securing switch to mounting bracket and remove switch.
5. Install new PTO switch to mounting bracket. Adjust switch so it is depressed 1/2" (13 mm) when PTO lever is moved to OFF position. Tighten jam nuts to 75 in-lb. Reinstall boot to switch.

IMPORTANT: Switch threads will be damaged if jam nuts are over tightened.

ELECTRICAL MAINTENANCE

6. Connect a continuity tester or ohm meter to switch connector. With PTO lever in the ON position the switch circuit should not have any continuity. If there is continuity, recheck switch installation. If there is no continuity, proceed to next step.
7. Move PTO lever to the OFF position. When PTO lever is in its normal, released position, the PTO switch should have continuity. If there is no continuity, recheck switch installation. If there is no continuity, proceed to next step.
8. Push switch connectors together.
9. Connect battery cable and install instrument cover.

SERVICING BATTERY

IMPORTANT: Before welding on the machine, disconnect ground cable from the battery to prevent damage to the electrical system.

Note: Check battery condition weekly or after every 50 hours of operation. Keep terminals and entire battery case clean because a dirty battery will discharge slowly. To clean the battery, wash the entire case with solution of baking soda and water. Rinse with clear water. Coat the battery posts and cable connectors with Grafo 112X (skin-over) grease (Toro Part No. 505-47) or petroleum jelly to prevent corrosion.

WIRING SCHEMATIC

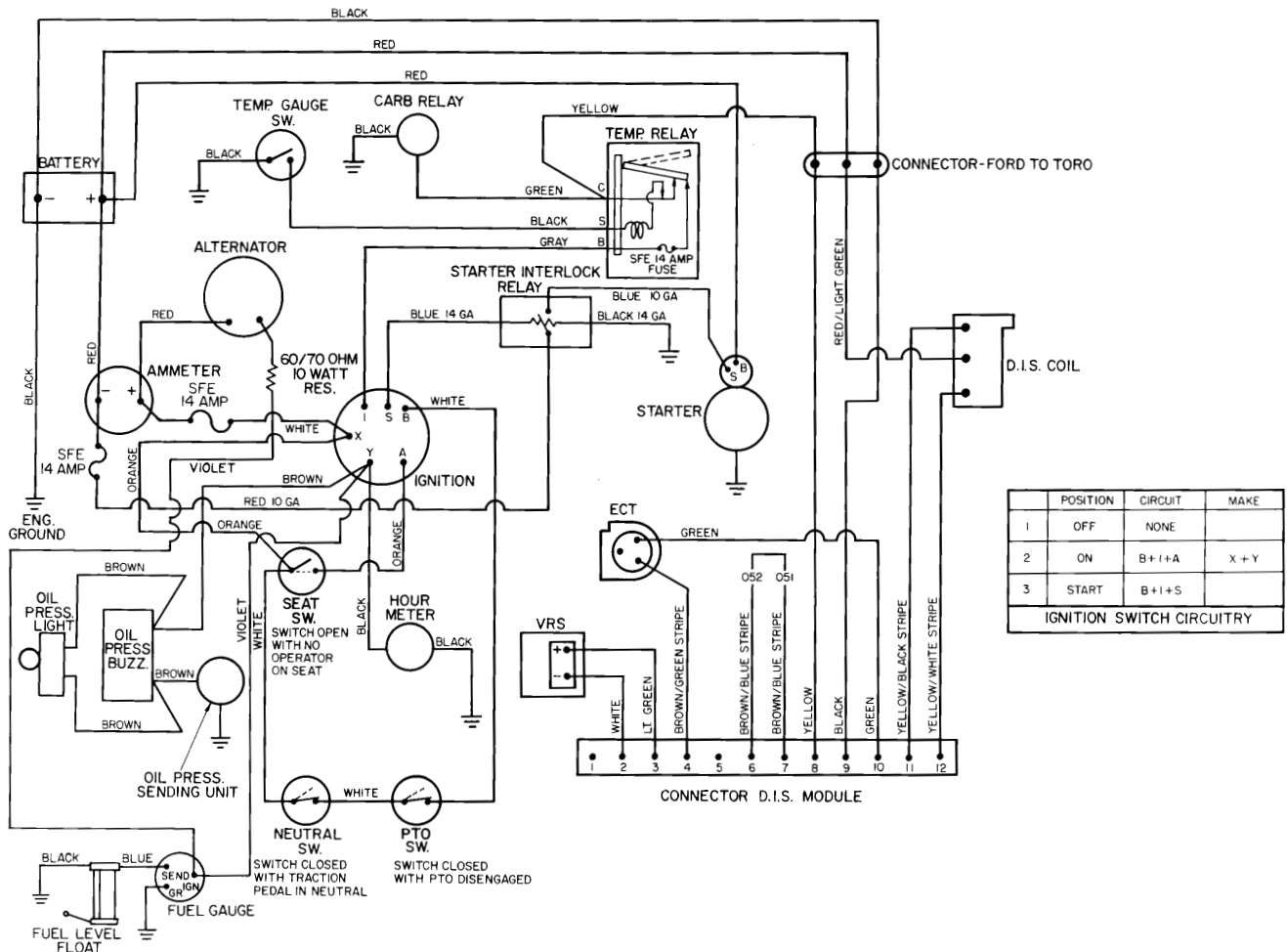

AIR CLEANER MAINTENANCE

GENERAL MAINTENANCE PRACTICES

Inspect air cleaner and hose periodically to maintain maximum engine protection and to ensure maximum service life.

1. Assure hose between air cleaner and carburetor is clamped securely in place. Replace the hose if it is cracked or punctured.
2. Check air cleaner body for dents and other damage which could possibly cause an air leak. Replace a damaged air cleaner body.
3. Be sure dust cap is sealing around bottom of air cleaner body.
4. Mounting screws and nuts holding air cleaner in place must be tight.
5. Inlet cap must be free of obstruction.

SERVICING DUST CUP AND BAFFLE

Inspect the dust cup and rubber baffle once a week or every 50 hours operation. However, daily or more frequent inspection is required when operating conditions are extremely dusty and dirty. Never allow dust to build up closer than one inch (25 mm) from the rubber baffle.

Note: If conditions are extremely dusty and dirty, begin by checking dust cup and baffle after each day's operation to establish approximately how long an interval passes before dust cup should be emptied. Base further maintenance requirements on this figure. These conditions may be particularly prevalent if the rear discharge cutting unit is attached.

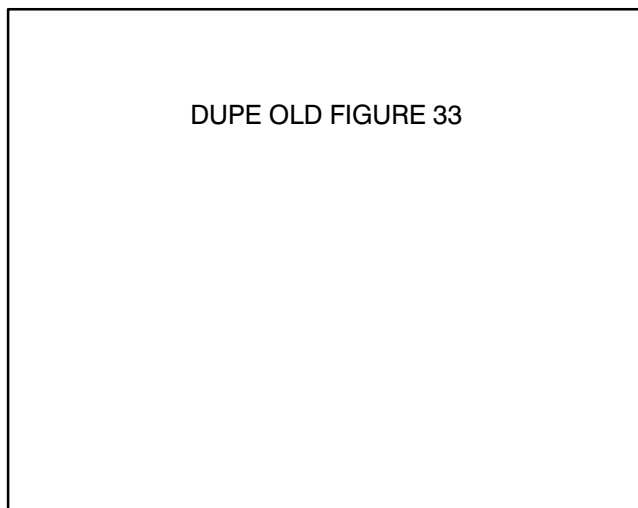

Figure 33

1. Thumbscrew
2. Dust cup
3. Baffle

1. Loosen thumb screw until dust cup and baffle can be removed (Fig. 33). Separate dust cup and baffle (Fig. 33).

2. Dump dust out of the dust cup. After cleaning cup and baffle, assemble and reinstall both parts.

SERVICING AIR CLEANER FILTER

Service the air cleaner filter every 250 hours or more frequently in extreme dusty or dirty conditions by washing or using compressed air. Replace the element after every six cleanings (1500 hours) or annually, whichever comes first.

1. Remove and service dust cup; refer to Servicing Dust Cup and Baffle.
2. Remove wing nut w/gasket and slide filter element out of air cleaner body (Fig. 34).

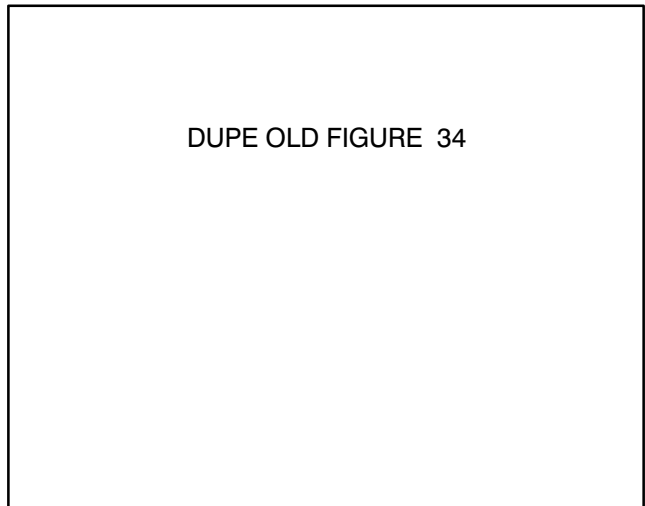

Figure 34

1. Wing nut with gasket
2. Filter element
3. Air cleaner body

3. Clean the element by washing it in a solution of filter cleaner (Toro Part No. 27-7220) and water, or blow dirt out of filter by using compressed air.

Note: Compressed air is recommended when element must be used immediately after servicing because a washed element must be dried before it is used. By comparison, washing the element cleans better than blowing dirt out with compressed air. Remember, though, filter must be washed when exhaust soot is lodged in the filter pores.

Washing Method

IMPORTANT: Do not remove plastic fin assembly because washing removes dust from beneath fins.

A. Prepare a solution of filter cleaner and water and soak filter element about 15 minutes. Refer to directions on filter cleaner carton for complete information.

B. After soaking filter for 15 minutes, rinse it with clear water. Maximum water pressure must not exceed 40 psi (276 kPa) to prevent damage to the filter element.

AIR CLEANER MAINTENANCE

C. Dry filter element using warm, flowing air (160°F (71°C) max), or allow element to air-dry. Do not use compressed air or a light bulb to dry the filter element because damage could result.

Compressed Air Method

IMPORTANT: Do not remove plastic fin assembly because back-blowing with compressed air removes dust from beneath fins.

A. Blow compressed air from inside to the outside of dry filter element. Do not exceed 100 psi (689 kPa) to prevent damage to the element.

B. Keep air hose nozzle at least one inch (25 mm) from pleated paper, and move nozzle up and down while rotating the filter element. Inspect element when dust and dirt are removed; refer to Inspecting Filter Element.

4. Wipe inside of air cleaner body with a damp cloth to remove excess dust. Slide filter into air cleaner body and secure it in place with wing nut and gasket.

5. Reinstall dust cup and baffle. Move thumb screw behind air cleaner body and tighten it securely.

INSPECTING FILTER ELEMENT

1. Place bright light inside filter.

2. Rotate filter slowly while checking for cleanliness, ruptures, holes, and tears. Replace defective filter element.

3. Check fin assembly, gasket, and screen for damage. Replace filter if damage is evident.

ENGINE MAINTENANCE

CLEANING RADIATOR AND SCREEN

The screen and front of the radiator must be kept clean to prevent the engine from overheating. Normally, check the screen and front of radiator daily and, if necessary, clean any debris off these parts. However, it will be necessary to check and to clean the screen each quarter hour and radiator checked every hour in extremely dusty and dirty conditions.

Note: This situation may be particularly prevalent if the rear discharge cutting unit is being used. The front of the radiator can be cleaned thoroughly by blowing with compressed air from the fan side of the radiator. Make sure to clean out any debris that settles to the bottom of the screen. The screen in front of radiator can be removed—by loosening wing nuts at top of screen—to make cleaning easier.

CHANGING CRANKCASE OIL AND FILTER

Check oil level after each day's operation or each time machine is used. Change oil and filter after first 50 hours and every 100 hours operation thereafter. However, change oil more frequently when engine is operated in dusty or sandy conditions. If possible, run engine just before changing oil because warm oil flows better and carries more contaminants than cold oil.

- 1.** Position machine on a level surface.
- 2.** Disengage hood latch and open the hood. Set drain pan under the housing and in line with drain plug.
- 3.** Clean area around drain plug.
- 4.** Remove oil drain plug and allow oil to flow into drain pan. Remove and replace oil filter; refer to parts catalog for part number.

5. After oil is drained, reinstall drain plug, and wipe up any oil that spilled.

6. Fill crankcase with oil; refer to Check Crankcase Oil.

REPLACING FUEL FILTER

Replace the fuel filter after every 400 hours of operation or yearly, whichever comes first.

- 1.** Disconnect elbow fitting from rear of fuel filter (Fig. 35).
- 2.** Disconnect front of filter from elbow fitting (Fig. 35).
- 3.** Install new filter and connect fittings. Start engine and check for leaks.

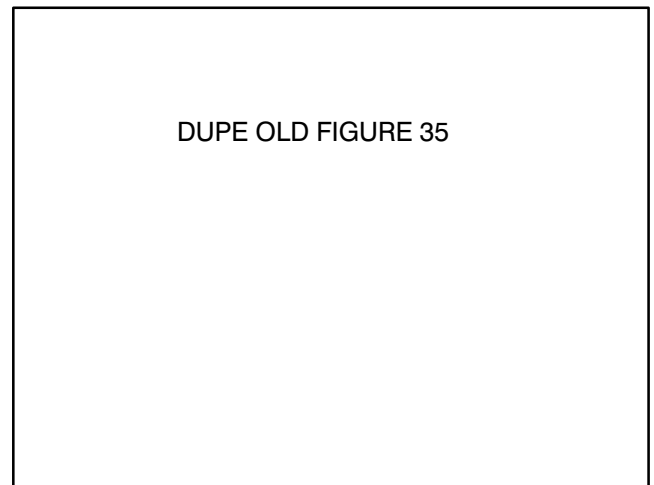

Figure 35

- 1.** Fuel filter
- 2.** Rear elbow
- 3.** Front elbow

ENGINE MAINTENANCE

SERVICING ENGINE BELTS

Check tension of all belts initially after the first day of operation and every 100 hours thereafter.

Alternator Belt

A new alternator belt (Fig. 36) is to be tensioned to 65 lbs. A used belt is to be tensioned to 40 lbs.

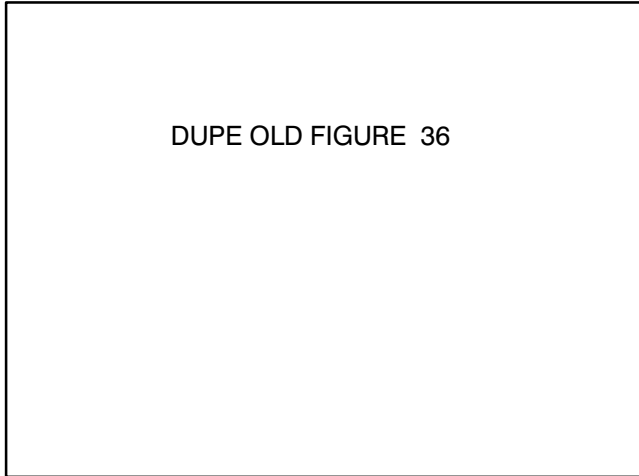

Figure 36

1. Alternator
2. Brace

1. To adjust belt tension, loosen bolt securing brace to engine, bolt securing alternator to brace and alternator mounting bolt (Fig. 36).
2. Insert pry bar between alternator and engine and pry out on alternator (Fig. 36).
3. Hold alternator in position after proper belt tension setting is achieved and tighten alternator and brace bolts to secure adjustment.

Cooling Fan Belt

A new cooling fan belt (Fig. 36) is to be tensioned to 65 lbs. A used belt is to be tensioned to 40 lbs.

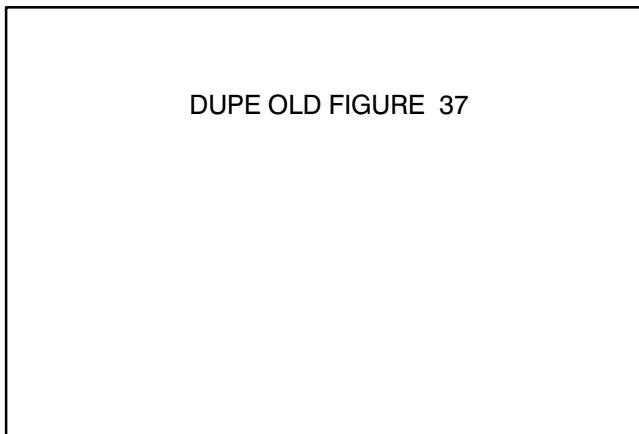

Figure 37

1. Idler arm
2. Engine mount

1. To adjust belt tension, loosen upper and lower nuts securing idler arm to front engine mount (Fig. 37).

2. Pull out on idler arm until desired belt tension is achieved.

3. Tighten mounting nuts to secure adjustment.

REPLACING SPARK PLUGS

Change spark plugs after every 400 operating hours to assure proper engine performance and reduce exhaust emission level.

Correct spark plug to use is a Motorcraft—AGSF22C or AGRF22 or equivalent.

Recommended air gap is .040" (1.016 mm).

Note: The spark plug usually lasts a long time; however, the plug should be removed and checked whenever the engine malfunctions.

1. Clean area around spark plugs so foreign matter cannot fall into cylinder when spark plug is removed.

2. Pull spark plug wires off spark plugs and remove plugs from cylinder head.

3. Check condition of side electrode, center electrode, and center electrode insulator to assure there is no damage.

IMPORTANT: A cracked, fouled, dirty or otherwise malfunctioning spark plug must be replaced. Do not sand blast, scrape, or clean electrodes by using a wire brush because grit may eventually release from the plug and fall into the cylinder. The result is usually a damaged engine.

4. Set air gap between center and side of electrodes at .040" (1.016 mm). Install correctly gapped spark plug and tighten plug to 11 – 15 ft–lb. If torque wrench is not used, tighten plug firmly.

5. Install spark plug wires.

CHANGING COOLANT IN COOLING SYSTEM

The cooling system must be filled with a 50/50 solution of water and permanent ethylene glycol anti-freeze. Every two years, drain the coolant from the radiator and engine by opening the drain cock and block plug. After coolant is drained, flush the entire system and refill it with a 50/50 solution of water and anti-freeze. Capacity of cooling system is approximately 6 quarts (5.7 L). When filling the radiator, level of coolant must be above the core and 1 inch (25 mm) below bottom of filler neck. **DO NOT OVERFILL.** Always install radiator cap securely.

ENGINE MAINTENANCE

ADJUSTING GOVERNOR

1. With engine shut off, move throttle control to FAST position and open hood. Check between the throttle arm and the stop on the carburetor base to make sure there is 1/32" (0.8 mm) gap (Fig. 38). If gap is not correct, adjust throttle rod (Fig. 38) by turning ball joint ends until gap is 1/32" (0.8 mm). If gap is correct, proceed to step 2.



WARNING

Engine must be running so final adjustment of the governor can be performed. To guard against possible personal injury, engage parking brake and keep hands, feet, face and other parts of the body away from fan or other moving parts.

2. Start engine and move throttle to SLOW position. Allow engine to warm up to normal operating temperature.

3. Rotate throttle arm closed until it contacts stop (Fig. 38).

DUPE OLD FIGURE 38

Figure 38

- | | |
|--------------------------------|-----------------|
| 1. 1/32" (0.8 mm) | 4. Stop |
| 2. Throttle rod | 5. Throttle arm |
| 3. Carburetor idle speed screw | |

4. Check idle speed and adjust carburetor idle speed screw if necessary to attain 1350 ± 50 rpm.

5. Release throttle arm, loosen jam nut on governor low idle speed screw and adjust it to attain 1500 ± 100 rpm (Fig. 38).

6. Slowly move throttle to FAST position until engine speed reaches 3200 ± 100 rpm. Shut off engine. Adjust high idle stop screw until it contacts speed control lever (Fig. 39).

IMPORTANT: Do not over speed the engine because the transmission could be damaged.

7. Move throttle rapidly from SLOW to FAST. The engine should not surge. If engine surges, proceed to step 8.

8. Check V-belts from engine to governor pulley and assure they are tight. If belts are loose, the engine will surge. If belts are tensioned properly, loosen jam nut that retains the anti-surge screw (Fig. 39). Rotate screw clockwise 1/8 turn at a time until surging stops. Should governor continue to surge, check the following:

- A. Carburetor too rich or too lean.
- B. Binding in throttle linkage.
- C. Governor worn internally.

DUPE OLD FIGURE 39

Figure 39

- | | |
|-------------------------|------------------------|
| 1. High idle stop screw | 5. Oil check plug |
| 2. Speed control lever | 6. low idle stop screw |
| 3. Jam nut | |
| 4. Anti-surge screw | |

IMPORTANT: Never rotate anti-surge screw in too far so that speed of engine increases.

9. Bump the throttle lever with your hand so engine speeds up momentarily. If governor is working properly, engine speed should return to normal within one or two surges of the governor. More than two surges of the governor usually indicates that the anti-surge screw must be turned in slightly more than it is. When adjustment is correct, lock jam nut against governor body.

10. Check low and high idle speed to be sure there is no change from the initial setting. If high idle speed has increased, anti-surge has been turned into the governor too far and it must be backed out. Then repeat the entire adjustment procedure.

ENGINE MAINTENANCE

Note: If the throttle control on the instrument panel will not stay in the FAST position during operation, remove the panel cover and tighten the nut and capscrew at base of throttle lever assembly.

CHECKING OIL LEVEL IN GOVERNOR

The governor is shipped with oil in it, but the level of oil must be checked after every 250 hours of operation.

1. Position machine on level surface and shut engine off.
2. Disengage hood latch and open the hood.
3. Clean area around check plug on governor (Fig. 39)
4. Remove check plug. Oil level must be up to bottom of filler hole. If oil level is low, remove oil fill plug and add same oil that is being used in engine. When oil is at point of overflowing out of check plug hole, install the check plug and fill plug.

SERVICING SPARK ARRESTOR MUFFLER

Every 250 hours operation, clear the muffler of carbon buildup.

1. Unlatch and raise hood assembly.
2. Remove pipe plug from clean-out port at lower side of muffler (Fig. 40).

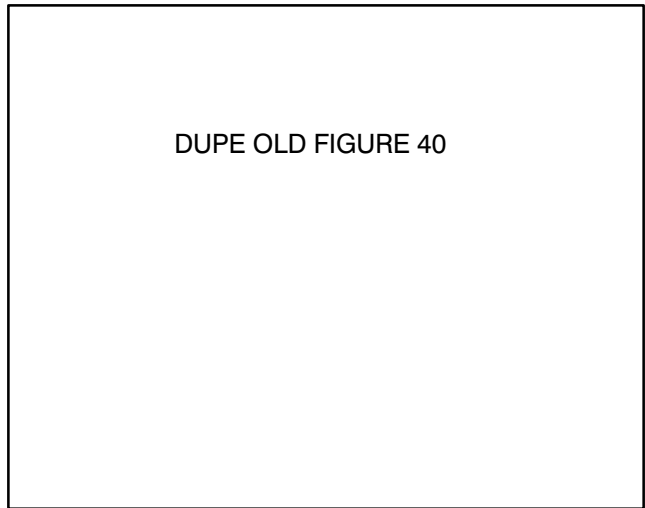

Figure 40

1. Muffler
2. Pipe plug
3. Outlet port
4. Block normal exhaust outlet



CAUTION

Be careful while working around muffler as it may be hot and could cause injury.

3. Start engine. Plug the normal muffler exit with block of wood or metal plate so exhaust flow will be forced out of the clean-out port (Fig. 53). Continue to block exit until carbon deposits cease coming out port.



CAUTION

Do not stand in line with the clean-out port. Always wear safety glasses.

4. Stop engine, replace pipe plug, and lower and latch hood.

TRACTION DRIVE MAINTENANCE

ADJUSTING TRACTION CONTROL ROD

1. Check traction drive neutral position to assure front wheels do not creep; refer to Adjusting Traction Drive for Neutral.
2. Press down on front of traction pedal and check travel. There should be approximately 3.50" clearance between end of pedal and floor plate when pedal in fully depressed (Fig. 41). Adjust pump control rod (Fig. 42) to attain dimension.

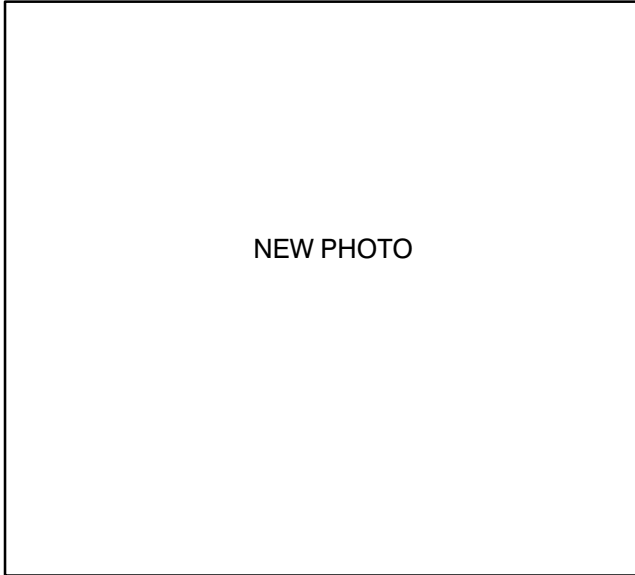

Figure 41

1. End of pedal
2. Floor plate
3. 3.50 in.

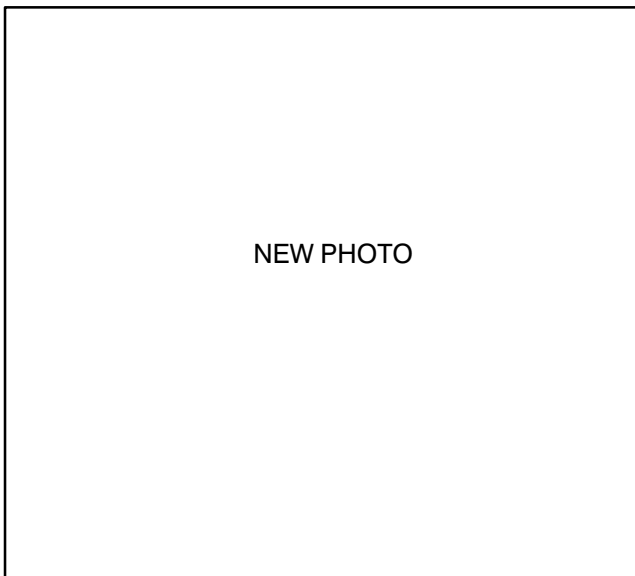

Figure 42

1. Control rod
2. Friction wheel

ADJUSTING TRACTION PEDAL FRICTION WHEEL

1. Loosen two nuts securing traction pedal shaft on right side of pedal (Fig. 42).
2. Rotate shaft to relocate worn surface of friction wheel away from underside of traction pedal.
3. Tighten nuts to secure shaft and wheel in position.

ADJUSTING TRACTION DRIVE FOR NEUTRAL

1. Park vehicle on a level surface and turn engine off. Apply the parking brake, tip seat forward, and actuate pump lever (Fig. 43) to insure assembly is properly seated and operating freely. Correct any discrepancy.

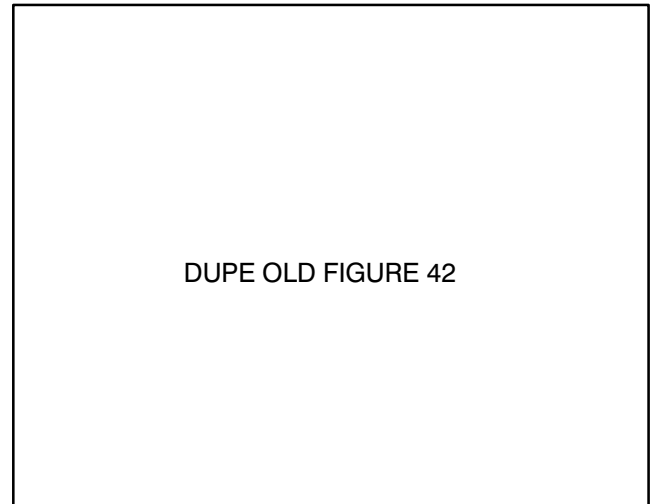

Figure 43

2. Block right front tire and both rear tires so vehicle cannot roll forward or backward.
3. Jack up frame so left front wheel is off the shop floor. Use a jack stand to support the frame.
4. Start engine and allow it to idle for 5 minutes to heat oil in transmission to operating temperature.
5. Release parking brake; then check left front wheel that is off shop floor. Wheel must not be rotating. If wheel is rotating, proceed to step 6 for an adjustment. If wheel is not rotating, proceed to step 8. Verify the adjustment with throttle in SLOW and FAST position.
6. Because the wheel is rotating, the pump plate must be adjusted. But before adjusting the pump plate, move throttle to SLOW. If wheel is rotating forward, loosen capscrews, and lightly tap bottom of pump plate counterclockwise (Fig. 43). By contrast, tap pump plate clockwise if wheel is rotating backward (Fig. 43). When wheel stops rotating, tighten capscrews holding pump plate against side of transmission. Verify the adjustment with throttle in SLOW and FAST position.

TRACTION DRIVE MAINTENANCE

7. Should front wheel continue to rotate, check for the following:

- A. Ball bearing is loose or worn out (Fig. 43).
 - B. Plunger on interlock switch is sticking.
 - C. Loose or missing fasteners.
 - D. Worn roll pin securing pump lever to transmission.
 - E. Pump lever loose on control shaft. (Correct by applying Loc-tite 271 or 601 to shaft.)
 - F. Weak or damaged leaf springs (Fig. 43). Replace.
 - G. Internal transmission component malfunction. Contact your local Toro distributor for assistance.
8. Shut engine off.

9. Adjust traction control rod; refer to Adjusting Traction Control Rod.

ADJUSTING TRACTION INTERLOCK SWITCH

- 1. Adjust transmission for neutral; refer to Adjusting Traction Drive for Neutral.
- 2. Actuate the pump lever (Fig. 43) to insure all parts are operating freely and seated properly.
- 3. Loosen jam nut. Rotate switch adjusting screw (Fig. 43) until there is a gap between head of screw and switch button.
- 4. Rotate adjusting screw until it contacts the switch button. Continue to rotate the screw until the circuit is completed (switch “clicks”). After the switch clicks, rotate the adjusting screw an additional 1/2 turn. Tighten jam nut.

PTO DRIVE MAINTENANCE

CORRECTING PTO DRIVE BELT SLIPPAGE

If belt begins to slip because it has stretched or because of worn linkage:

- 1. Unlatch and remove instrument cover.
- 2. Move PTO control lever to ON position.
- 3. Measure length of PTO spring between flat-washers (Fig. 44). There should be a spring length of 3-3/16 inches (81 mm).
- 4. To adjust, hold head of adjusting screw with wrench (under PTO actuating arm) and turn locknut (Fig. 44).
- 5. Move PTO lever to OFF position and install instrument cover.

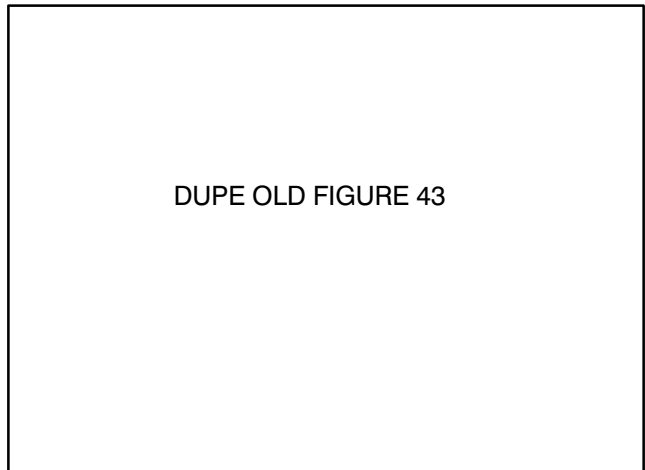

Figure 44

- 1. 3-3/16 in. (81 mm)
- 2. PTO actuating arm
- 3. Locknut

STEERING MAINTENANCE

ADJUSTING TILT STEERING CONTROL

If steering wheel tilt control lever must be adjusted, proceed as follows:

1. Remove knob from parking brake and self tapping screws from steering column cover. Slide cover up steering shaft to expose pivot bracket (Fig. 45).
2. Loosen small nut, rotate pivot bracket until it tightens large nut below (Fig. 45). Retighten small nut.
3. Reinstall steering column cover and parking brake knob.

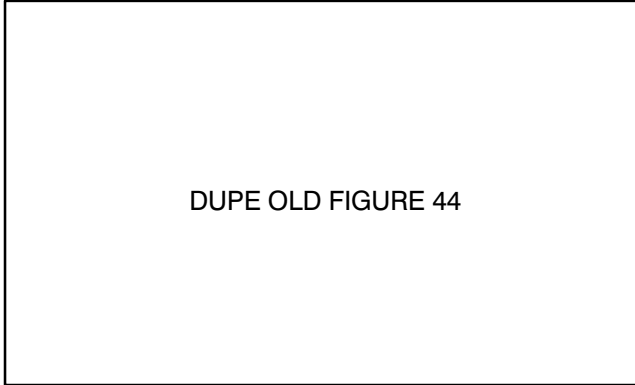

Figure 45
1. Pivot Plate
2. Small Nut
3. Large Nut

ADJUSTING REAR WHEEL TOE-IN

The rear wheels should not toe-in or toe-out when they are adjusted correctly. To check the rear wheel toe-in, measure the center-to-center distance at wheel hub height, in front and in back of the rear tires. If the wheels toe-in or toe-out, an adjustment is required.

1. Rotate the steering wheel so rear wheels and steering plate are straight ahead.
2. Loosen the jam nuts on both tie rods Adjust both tie rods until center-to-center distance at front and back of rear wheels is the same (Fig. 46).
3. When rear wheels are adjusted correctly, tighten jam nuts against tie rods.

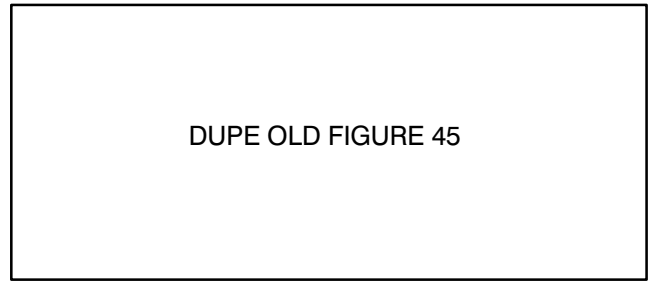

Figure 46
1. Steering plate

ADJUSTING REAR WHEEL BEARINGS

1. Jack up rear of machine until wheel is off shop floor. Use jack stands or block the machine to prevent it from accidentally falling.
2. Remove dust cap from end of wheel spindle. Also remove cotter pin retaining slotted nut in place (Fig. 47).
3. Rotate the wheel by hand and tighten the slotted nut until the bearing binds slightly. Then loosen nut until the nearest slot and hole in spindle line up. Install the cotter pin to retain the slotted nut in place.
4. Install dust cap on end of wheel spindle.
5. Remove jack stands and lower machine to shop floor.

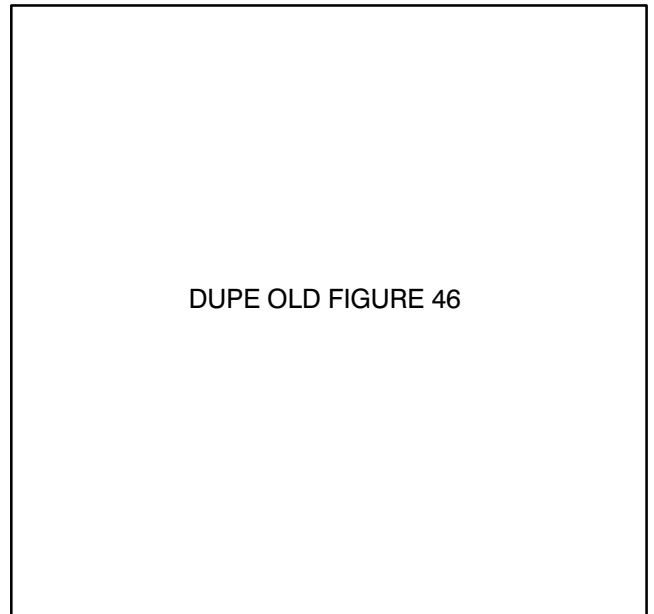

Figure 47
1. Slotted nut

BRAKE MAINTENANCE

ADJUSTING BRAKES

Adjust the service brakes when there is more than one inch (25 mm) of “free travel” of the turn pedals, or when the brakes do not work effectively. Free travel is the distance the brake pedal moves before braking resistance is felt.

The brakes should only need adjusting after considerable use. These periodic adjustments can be performed where the brake cables connect to the brake pedal mount. When the cables are no longer adjustable, the star nut on the inside of the brake drum must be adjusted to move the brake shoes outward. However, the brake cables must be adjusted again to compensate for this adjustment.

1. To reduce free travel of turn pedals—tighten the brakes—loosen front nut on threaded end of brake cable (Fig. 48). Then tighten rear nut to move cable backward until turn pedals have 1/2 to 1 inch (13 to 25 mm) of free travel. Tighten front nut after brakes are adjusted correctly.

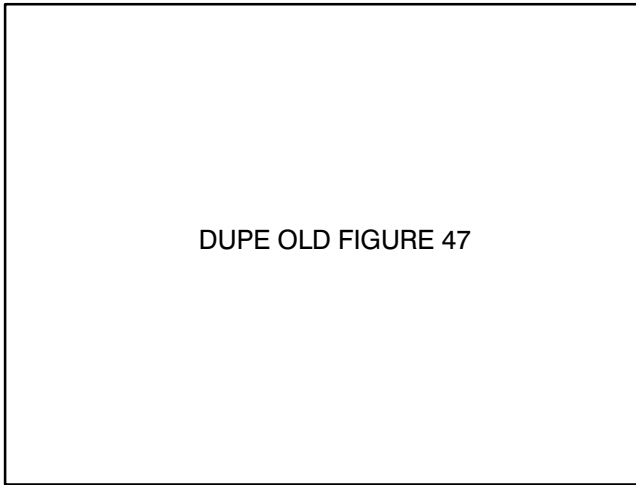

Figure 48
1. Jam nut

2. When adjustment of brake cable cannot get free travel within 1/2 to 1 inch (13 to 25 mm), the star nut inside the brake drum must be adjusted. However, before adjusting the star nut, loosen brake cable nuts to prevent unnecessary strain on the cables.

3. Loosen five wheel nuts holding wheel and tire assembly on wheel studs.

4. Jack up machine until front wheel is off the shop floor. Use jack stands or block the machine to prevent it from falling accidentally.

5. Remove wheel nuts and slide wheel and tire assembly off studs. Rotate brake drum until adjusting

slot is at bottom and centered over star nut that adjusts brake shoes (Fig. 49).

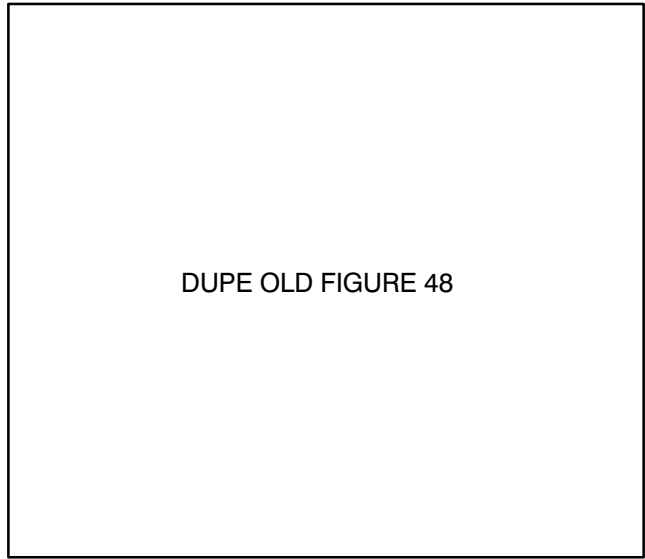

Figure 49
1. Slot

6. Using a brake adjusting tool or screwdriver, rotate star nut down until brake drum locks because of outward pressure of brake shoes (Fig. 50).

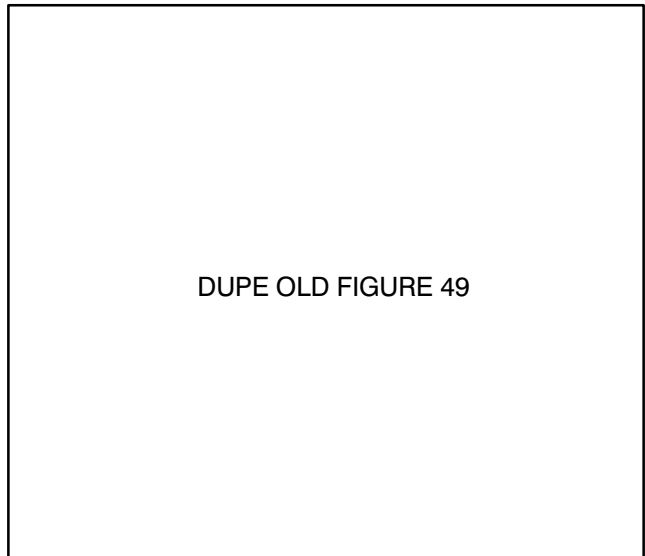

Figure 50
1. Star nut 2. Brake shoes

7. Loosen star nut about 12 to 15 notches or until brake drum rotates freely.

8. Install wheel and tire assembly on studs with five wheel nuts. Tighten nuts to 45-55 ft-lb (61-75 N·m).

9. Remove jack stands or blocking and lower machine to the shop floor.

10. Adjust the brake cables using step 1.

HYDRAULIC SYSTEM MAINTENANCE

ADJUSTING LIFT LEVER LATCH

A lift lever latch that is positioned incorrectly can cause the lift lever to hold the spool in an actuated position when the implement is in the FLOAT position. This causes oil in the hydraulic system to overheat. When lift lever latch is adjusted correctly, the lift lever should just clear the rounded part of the latch as lever is moved into FLOAT position.

1. Unscrew ball from lift lever.
2. Remove self tapping screws and lift cover off lift lever to expose the latch.
3. Loosen two capscrews on top of the lift lever latch (Fig. 51). Place lever on rounded tip of latch (Fig. 51), and slide latch w/lever forward until stopping resistance is felt. Then tighten capscrews to lock the latch in place. Check for free operation of the lift lever by moving lever from RAISE or TRANSPORT to FLOAT position. Lift lever should just clear rounded position of latch as lever is moved into FLOAT position.
4. Slide cover into place and install it with self tapping screws. Screw ball onto lift lever.

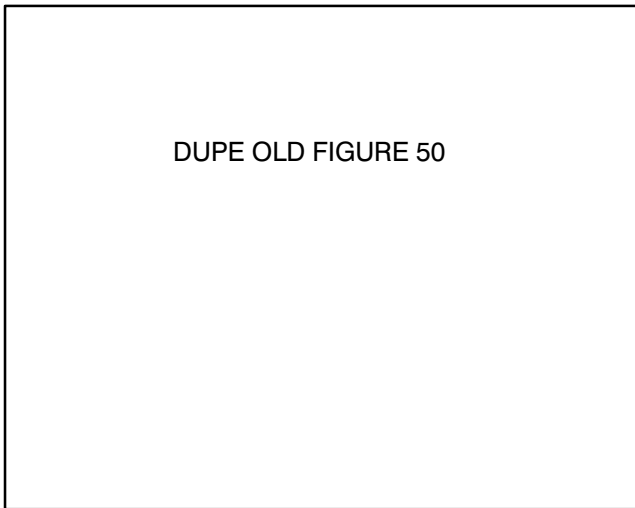

DUPE OLD FIGURE 50

Figure 51

1. Capscrews
2. Rounded tab
3. Lift lever

REPLACING HYDRAULIC OIL FILTER

The hydraulic oil filter keeps the hydraulic system relatively free of contaminants and must be serviced at regular intervals. **Initially, change filter after first ten hours of engine operation, and thereafter, after every 200 hours of operation or yearly, whichever comes first.** Use TORO oil filter, Part No. 23-9740, as a replacement.

1. Clean area where hydraulic oil filter mounts. Remove filter from base (Fig. 52) and clean filter mounting surface.

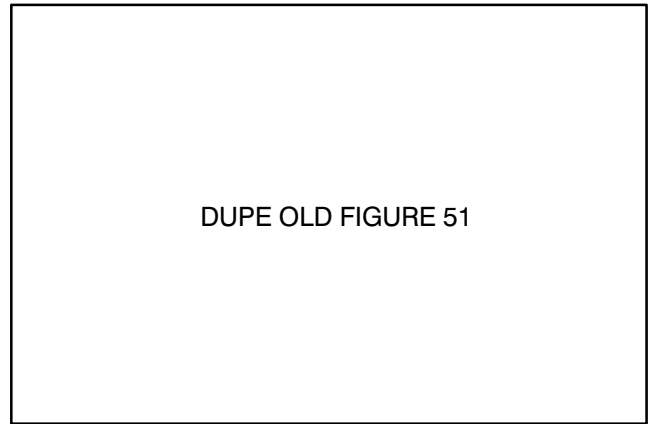

DUPE OLD FIGURE 51

Figure 52

1. Hydraulic oil filter

2. Lubricate filter gasket with proper viscosity and type oil. Then fill filter using the same oil.
3. Install filter by hand until gasket contacts mounting head. Then rotate an additional 1/2 turn.
4. Start engine and check for hydraulic oil leaks. Allow engine to run for about two minutes so any air in the system is purged (removed).
5. Shut engine off and check level of hydraulic system; refer to Check Hydraulic System Oil.

CHANGING HYDRAULIC SYSTEM OIL

The hydraulic system oil must be changed after every 1000 hours of operation or seasonally, whichever comes first. The hydraulic system is designed to operate on any high quality detergent oil having the American Petroleum Institute—APO—“service classification” SF/CC or CD. Oil viscosity—weight—must be selected according to anticipated ambient temperature for the season in which product will be used.

Temperature/viscosity recommendations are:

Expected Ambient Temperature	Recommended Viscosity and Type
(Extreme) over 90° F	SAE 30, Type SF/CC or CD engine oil.
(Normal) 40°-100° F	SAE 10W-30 or 10W-40, Type SF/CC or CD engine oil.
(Cool—Spring/Fall) 30°-50° F	SAE 5W-30, Type SF/CC or CD engine oil.
(Winter) Below 30° F	Type “F” or “FA” ATF Automatic Transmission Fluid.

Note: Do not mix engine oil and automatic transmission fluid or hydraulic system component damage may result. When changing fluids, also change transmission filter. **DO NOT USE DEXRON II ATF.**

HYDRAULIC SYSTEM MAINTENANCE

Note: Fluid to operate the power steering is supplied by the hydraulic system transmission charge pump. Cold weather start–up may result in “stiff” operation of the steering until the hydraulic system has warmed up. Using proper weight hydraulic oil in system minimizes this condition.

The axle housing acts as the reservoir for the system. The transmission and axle housing are shipped from the factory with approximately 5 quarts (4.7 L) of SAE 10W-30 engine oil. However, check level of transmission oil before engine is first started and daily thereafter.

1. Start engine, park machine on a level surface, lower implement to the shop floor, set the parking brake, and shut engine off. Block the two rear wheels.
2. Jack up both sides of front axle and support it with jack stands.
3. Clean area around hydraulic oil filter and remove filter.
4. Remove drain plug from fitting between axle housing and oil filter and allow oil to flow into drain pan (Fig. 53).
5. Install new filter; refer to steps 1-2 in Replacing Hydraulic Oil Filter, for proper procedures.
6. Install drain plug in fitting between axle housing and oil filter (Fig. 53).
7. Remove dipstick from axle filler tube (Fig. 54) and fill axle to proper level with correct type and viscosity oil recommended for expected ambient temperature conditions; refer to table above.
8. Start and run the engine at idle speed for about two minutes and turn the steering wheel lock to lock to purge air trapped in the system. Shut the engine off.

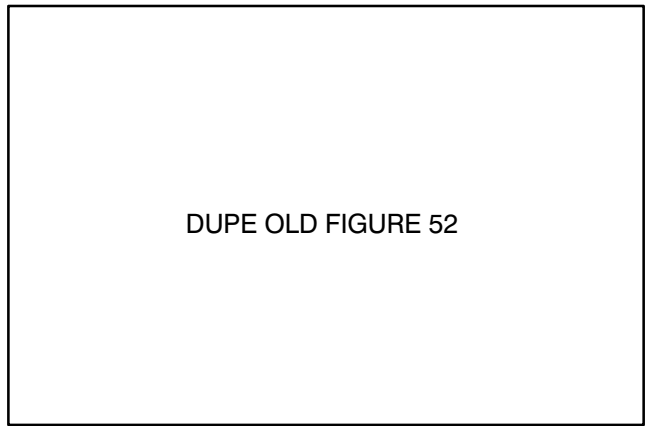

Figure 53

1. Drain plug

9. Leave machine set for two additional minutes, then remove dipstick and check oil level in axle (Fig. 54). If level is low, add oil until level matches groove in dipstick (Fig. 54). If level is too high, remove drain plug (Fig. 53) and drain oil until oil level matches groove in dipstick.

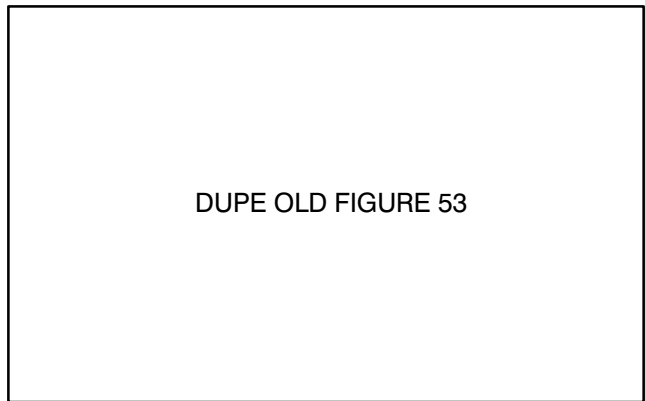
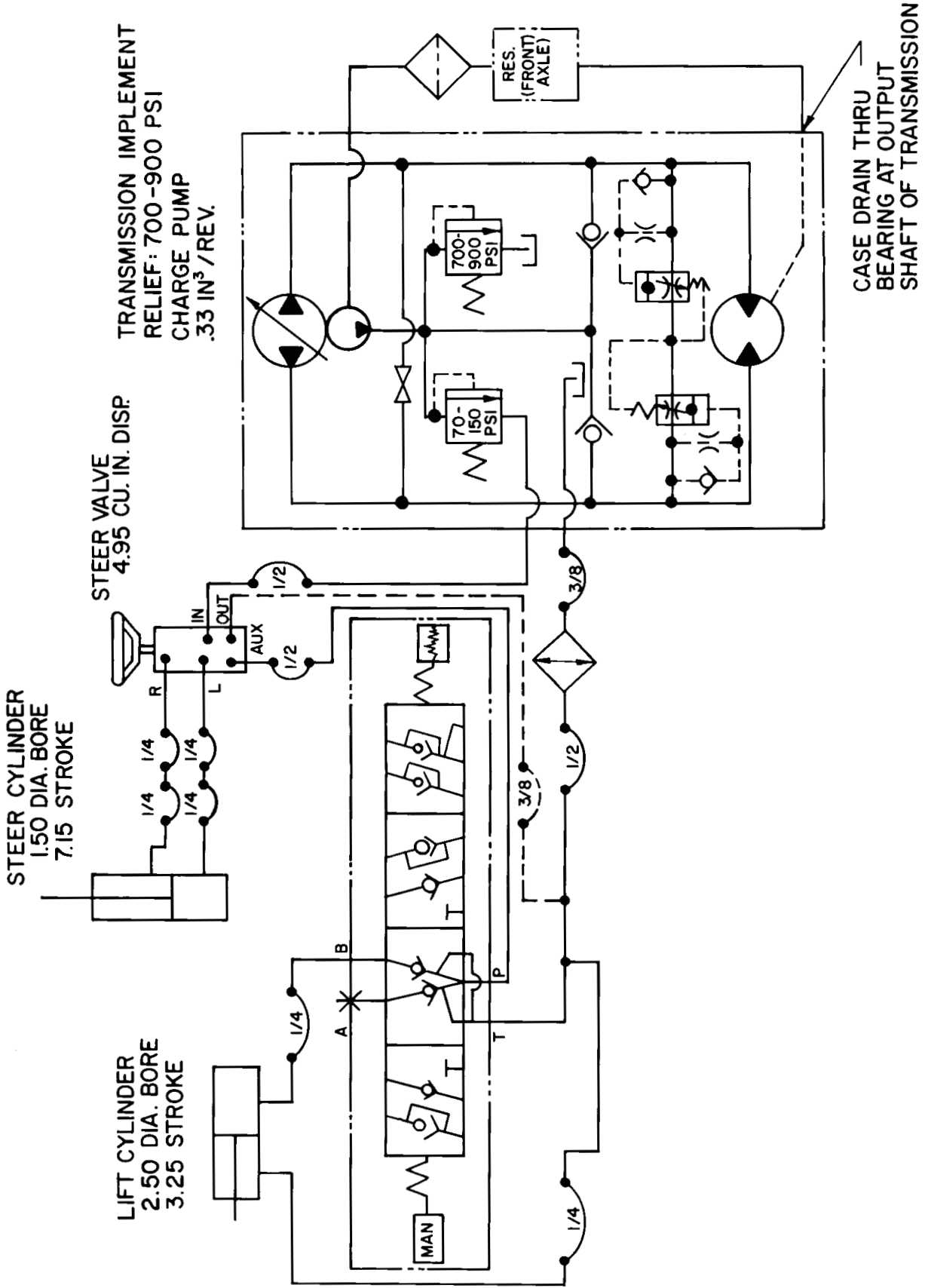

Figure 54

1. Dipstick
2. Groove

HYDRAULIC SCHEMATIC



IDENTIFICATION AND ORDERING

MODEL AND SERIAL NUMBERS

The Groundsmaster® 345 has two identification numbers: a model number and a serial number. These numbers are stamped into a plate located on front bulkhead left of seat. In any correspondence concerning the unit, supply the model and serial numbers to ensure correct information and replacement parts are obtained.

To order replacement parts from an authorized TORO Distributor, supply the following information:

1. Model and serial numbers.
2. Part number, description, and quantity of parts desired.

Note: Do not order by reference number if a parts catalog is being used; use the part number.

PREPARATION FOR SEASONAL STORAGE

Traction Unit

1. Thoroughly clean the traction unit, cutting unit and the engine, paying special attention to these areas:
 - radiator screen
 - underneath the cutting unit
 - under the cutting unit belt covers
 - counterbalance springs
 - P.T.O Shaft Assembly
 - all grease fittings and pivot points
2. Check the tire pressure. Inflate all traction unit tires to 21 psi (145 kPa).
3. Remove, sharpen, and balance the cutting unit's blades. Reinstall the blades and torque the blade fasteners to specifications.
4. Check all fasteners for looseness; tighten as necessary.
5. Grease or oil all grease fittings and pivot points. Wipe up any excess lubricant.
6. Ensure that the P.T.O. belt remains in the disengaged position so that the P.T.O. belt does not take a "set."
7. Lightly sand and use touch-up paint on painted areas that are scratched, chipped, or rusted. Repair any dents in the metal body.
8. Service the battery and cables as follows:
 - a. Remove the battery terminals from the battery posts.
 - b. Clean the battery, terminals, and posts with a wire brush and baking soda solution.

c. Coat the cable terminals and battery posts with Grafo 112X skin—over grease (Toro Part No. 505-47) or petroleum jelly to prevent corrosion.

d. Slowly recharge the battery every 60 days for 24 hours to prevent lead sulfation of the battery.

Engine

1. Drain the engine oil from the oil pan and replace the drain plug.
2. Remove and discard the oil filter. Install a new oil filter.
3. Refill the engine with recommended motor oil. Refer to changing crankcase oil.
4. Start the engine and run at idle speed for approximately two minutes. **DO NOT RUN LONGER THAN TWO MINUTES.**
5. Stop the engine; remove all spark plugs.
6. Pour one ounce (28cc) of clean engine oil in each spark plug hole.
7. With the coil connector removed, crank the engine with the starter for at least 12 revolutions to distribute the oil in the cylinders.
8. Reinstall the spark plugs. Reconnect the coil connector.
9. Drain the gasoline from the fuel tank, fuel lines, and the carburetor bowl. Reinstall all lines and secure all connections.
10. Thoroughly clean and service the air cleaner assembly.
11. Seal the air cleaner inlet, the exhaust outlet and the crankcase breather with weatherproof tape.
12. Check the oil filter cap, gas cap and radiator cap to ensure they are all securely in place.

MAINTENANCE SCHEDULE

Minimum Recommended Maintenance Intervals

Maintenance Procedure	Maintenance Interval & Service			
<div style="border: 1px solid black; padding: 5px; margin-bottom: 5px;"> Check Battery Fluid Level Check Battery Cable Connections Lubricate All Grease Fittings Lubricate Brake Cables Check Cutting Unit Gear Box Oil Level Clean Under Cutting Unit Belt Covers Check Cutting Unit Drive Belt Adjustment Check PTO Belt Tension Inspect Air Filter, Dust Cup, and Baffle </div>	Every 50hrs	Every 100hrs	Every 200hrs	Every 400hrs
‡ Change Engine Oil and Filter † Check Fan and Alternator Belt Tension Inspect Cooling System Hoses				
† Replace Transmission Oil Filter Service Air Filter Check Governor Oil Level Decarbon Spark Arrestor Muffler Check Rear Wheel Toe-In and Steering Linkage † Torque Wheel Lug Nuts				
Replace Fuel Filter Change Transmission Oil Change Cutting Unit Gear Box Oil Replace Spark Plugs Pack Rear Wheel Bearings ‡ Torque Head, Adjust Valves and Check Engine RPM				
† Initial break in at 10 hours ‡ Initial break in at 50 hours				
Replace Moving Hoses Replace Safety Switches Coolant System – Flush/Replace Fluid	Annual Recommendations: Items listed are recommended every 1000 hours or 2 years, whichever occurs first.			

The Toro Promise

A Limited Warranty

The Toro Company promises to repair your TORO GROUNDMASTER® MOWER and its originally purchased cutting unit, if defective in materials or workmanship. The following time periods from the date of purchase apply (special warranty terms, on certain components, may be offered through The Toro Company by the component manufacturers):

**Model 30789 Two Years or 1500 operational hours,
whichever comes first**

The cost of parts, labor and transportation are included.

If you feel your TORO Product is defective and wish to rely on The Toro Promise, the following procedure is recommended:

1. Contact your Authorized TORO Distributor or Commercial Dealer (the Yellow Pages of your telephone directory is a good reference source).
2. The TORO Distributor or Commercial Dealer will advise you on the arrangements that can be made to inspect and repair your product.
3. The TORO Distributor or Commercial Dealer will inspect the product and advise you whether the product is defective and, if so, make all repairs necessary to correct the defect without an extra charge to you.

If for any reason you are dissatisfied with the distributor's analysis of the defect or the service performed, you may contact us.

Write:

TORO Commercial Products Service Department
8111 Lyndale Avenue South
Minneapolis, MN 55420-1196

The above remedy of product defects through repair by an Authorized TORO Distributor or Commercial Dealer is the purchaser's sole remedy for any defect.

THERE IS NO OTHER EXPRESS WARRANTY. ALL IMPLIED WARRANTIES OF MERCHANTABILITY AND FITNESS FOR USE ARE LIMITED TO THE DURATION OF THE EXPRESS WARRANTY.

Some states do not allow limitations on how long an implied warranty lasts, so the above limitation may not apply to you.

This Warranty applies only to parts or components which are defective and does not cover repairs necessary due to normal wear, misuse, accidents, or lack of proper maintenance. Regular, routine maintenance of the unit to keep it in proper operating condition is the responsibility of the owner.

All warranty repairs reimbursable under The Toro Promise must be performed by an Authorized Toro Commercial Dealer or Distributor using Toro approved replacement parts.

Repairs or attempted repairs by anyone other than an Authorized TORO Distributor or Commercial Dealer are not reimbursable under the TORO Promise. In addition, these unauthorized repair attempts may result in additional malfunctions, the correction of which is not covered by warranty.

THE TORO COMPANY IS NOT LIABLE FOR INDIRECT, INCIDENTAL OR CONSEQUENTIAL DAMAGES IN CONNECTION WITH THE USE OF THE PRODUCT INCLUDING ANY COST OR EXPENSE OF PROVIDING SUBSTITUTE EQUIPMENT OR SERVICE DURING PERIODS OF MALFUNCTION OR NON-USE.

Some states do not allow the exclusion of incidental or consequential damages, so the above exclusion may not apply to you.

This warranty gives you specific legal rights, and you may also have other rights which vary from state to state.

COUNTRIES OTHER THAN THE UNITED STATES OR CANADA

Customers who have purchased TORO products exported from the United States or Canada should contact their TORO Distributor (Dealer) to obtain guarantee policies for your country, province, or state. If for any reason you are dissatisfied with your Distributor's service or have difficulty obtaining guarantee information, contact the TORO importer. If all other remedies fail, you may contact us at The Toro Company.