



MODEL NO. 51556 – 39000001 & UP

OPERATOR'S
MANUAL

7 INCH CORDLESS TRIMMER

IMPORTANT SAFETY INSTRUCTIONS

WARNING

To ensure maximum safety, best performance, and to gain knowledge of the product, it is essential that you or any other operator of the trimmer read and understand the contents of this manual before the motor is ever started. Pay particular attention to the safety alert symbol which means CAUTION, WARNING, OR DANGER — “personal safety instruction.” Read and understand the instruction because it has to do with safety. FAILURE TO COMPLY WITH INSTRUCTION MAY RESULT IN PERSONAL INJURY.

SAVE THESE INSTRUCTIONS FOR FUTURE REFERENCE

1. Read and understand Operator's Manual before using trimmer. Be thoroughly familiar with proper use of trimmer.
2. Never allow children to operate trimmer. It is not a toy. Never allow adults to operate unit without first reading the Operator's Manual.
3. Always wear safety glasses or other suitable eye protection.
4. Keep the area of operation clear of all persons, particularly small children and pets.
5. Dress Properly—Do not wear loose clothing or jewelry. They can be caught in moving parts. Always wear substantial footwear and long pants.
6. Use the right appliance—Do not use the appliance for any job except that for which it was intended.
7. Avoid unintentional starting. Do not carry trimmer with finger on switch.
8. Do not force the trimmer. It operates better and safer at the rate for which it was designed.
9. Do Not Overreach—Keep proper footing and balance at all times when operating the trimmer. Keep a firm hold on the handles and walk, never run.
10. Stop the motor whenever you leave the trimmer, before cleaning the housing, and when making any repairs or inspections.
11. When not in use, store your trimmer in a dry, cool place; high or locked up out of the reach of children.
12. Keep all fasteners tight to ensure the trimmer is in safe working condition.
13. Never operate trimmer without proper guards or other protective safety devices in place and working.
14. Do not put hands or feet near or under rotating parts. Keep clear at all times.
15. Do not invert trimmer while trimmer is in operation. Do not push down the trigger release and depress the ON/OFF switch while trimmer is in inverted position.
16. If the trimmer should start to vibrate abnormally, stop the motor and check immediately for the cause. Vibration is generally a warning of trouble.
17. Do not operate your Toro trimmer after it has been dropped or damaged. Return it to your nearest authorized service dealer for inspection and repair.
18. Maintain Appliance With Care—Keep cutting head and motor housing clean for best performance and to reduce the risk of injury. Follow General Maintenance Instructions on page 10.
19. **CAUTION**—Cutting knife on grass shield is sharp and care should be taken when cleaning and handling.
20. Avoid Dangerous Environment—Never operate the trimmer in wet or damp conditions.
21. **WARNING**—To reduce risk of electrical shock or fire, replace charger immediately if case or cord is damaged.
22. When servicing, use only identical TORO replacement parts. Use only TORO charger (73-5410) and TORO battery (33-6650).



SAFETY DECALS AND INSTRUCTIONS

Safety decals and instructional decals are easily visible to the operator and are located near any area of potential danger. Replace any decal that is damaged or lost.

BATTERY RECYCLING SYMBOL



SEALED LEAD ACID BATTERY DISPOSAL INSTRUCTIONS

In compliance with Federal and State Regulations, we must inform you that the BATTERY used in this product:

- CONTAINS TOXIC MATERIAL — LEAD ELECTRODES.
- CONTAINS CORROSIVE FLUIDS — SULFURIC ACID.

The BATTERY in your trimmer is sealed. Under normal usage it will not leak or spill, therefore:

1. DO NOT PUNCTURE, DISASSEMBLE, MUTILATE OR INCINERATE BATTERY.
2. DO NOT USE THIS BATTERY WITH ANY OTHER PRODUCT OR PRODUCTS EXCEPT THE PRODUCT YOU RECEIVED IT WITH. FAILURE TO COMPLY COULD CAUSE EXTENSIVE DAMAGE TO THE PRODUCT AND MAY CAUSE PERSONAL INJURY. ANY IMPROPER USE OF THIS BATTERY WILL VOID ITS WARRANTY.
3. USE ONLY THE CHARGER SUPPLIED WITH THIS PRODUCT. USE OF ANY CHARGER OTHER THAN THAT SUPPLIED COULD CAUSE EXTENSIVE DAMAGE TO THE BATTERY AND/OR PRODUCT AND MAY CAUSE PERSONAL INJURY. USE OF ANY OTHER CHARGER WITH THIS BATTERY WILL VOID ITS WARRANTY.

When the BATTERY is no longer functional, it must be RECYCLED as stated in instructions on page 10.

ON BATTERY

SAFETY INSTRUCTIONS RECHARGEABLE BATTERY	
DANGER	
ALL BATTERIES CONTAIN CORROSIVE ACIDS AND PRODUCE EXPLOSIVE GASES DURING RECHARGING	
GAS EXPLOSION CAN CAUSE BLINDNESS OR INJURY SHIELD EYES	BATTERY ACID CAN CAUSE BLINDNESS OR SEVERE BURNS
<ul style="list-style-type: none"> • Do not make direct contact between Battery Terminals as this can cause an explosion or fire. • Batteries should not be stored discharged. • Only Adults should recharge batteries. • Keep charger away from children. • Use only the charger provided by TORO • Do not recharge batteries upside down. • Charging produces explosive gases. Charge battery in a well ventilated area away from sparks, flames and smoking. • Disconnect charger from battery after 48 hours. 	
INTERNAL TAKE MILK WHITES OF EGGS WATER DO NOT INDUCE VOMITING	EXTERNAL FLUSH IMMEDIATELY FOR 15 MINUTES IF ACID GETS IN EYES OR ON SKIN
CALL PHYSICIAN IMMEDIATELY	

ON BATTERY (Part No. 73-5960)

DISPOSING OF BATTERY
<ol style="list-style-type: none"> 1. When a battery is no longer functional, it must be disposed of AT AN E.P.A. REGISTERED RECLAMATION FACILITY. Check your local telephone directory for the nearest facility. 2. It is <u>UNLAWFUL</u> to dispose of the battery in any landfill. <u>DO NOT</u> dispose of the battery in any landfill.
<p><u>HELP US PROTECT THE ENVIRONMENT!!</u></p>

ON TRIMMER HOUSING (Part No. 73-5370)

	Charging
MODEL 5959	6VOLT DC
CAUTION:	
WARNING:	
<small>Mfg. under U.S. Patent Nos. 4,112,041 and 4,572,451 Other U.S. and Foreign Patents pending.</small>	
SERIAL NUMBER	
The Toro Co. Minneapolis, MN 55420	1 2 3 4

TABLE OF CONTENTS

	Page		Page
Assembly Instructions	3	Battery Disposal and Instructions	10
Before Operating	4	General Maintenance	10
Operating Instructions	6	Identification and Ordering	11
Tips for Best Trimming Results	7	Accessories	11
Lengthening Cutting Line	8	The Toro Promise	
Replacing Cutting Line	9		

ASSEMBLY INSTRUCTIONS

LOOSE PARTS

Your trimmer comes in one carton. Check the list below to be sure you received all component parts.

Registration Card
Battery Housing
Cutter Head And Tube Assembly
Charger
Operator's Manual
Accessory Order Form

Loose Parts Bag Includes:

- (2) #10 x 1-1/2" long screws
- (2) #10 hex nuts

TOOLS NEEDED FOR ASSEMBLY

1 — medium Phillips head screwdriver

ASSEMBLY

1. Trimmer should appear as shown in Figure 1 when fully assembled.

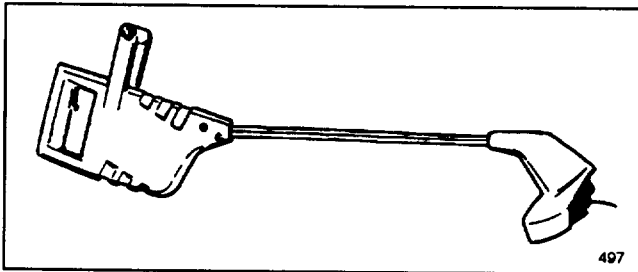

Figure 1

2. If connector plug has retracted into the trimmer housing, use the hang tag string to pull the connector out of the housing (Fig. 2).

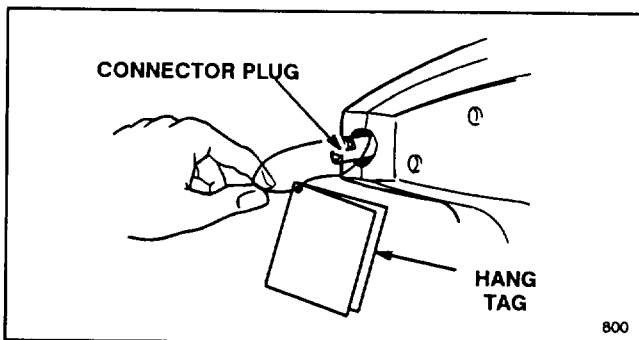

Figure 2

3. Grasp handle tube firmly with one hand and the connector plug extending out of housing with the other (Fig. 3).

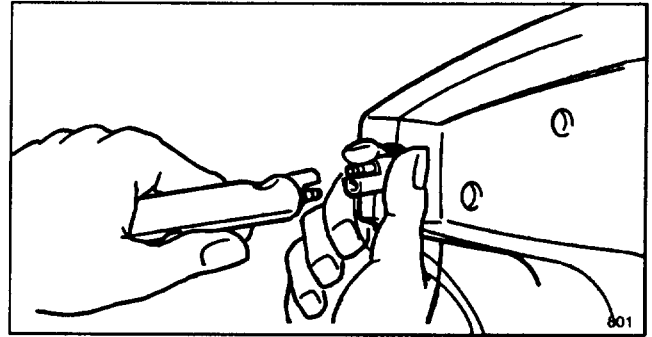

Figure 3

4. Connect plug in battery housing with connector plug extending out of tube (Fig. 4). **BE SURE CONNECTORS ARE SECURELY CONNECTED TO ONE ANOTHER BEFORE INSERTING TUBE INTO HOUSING.**

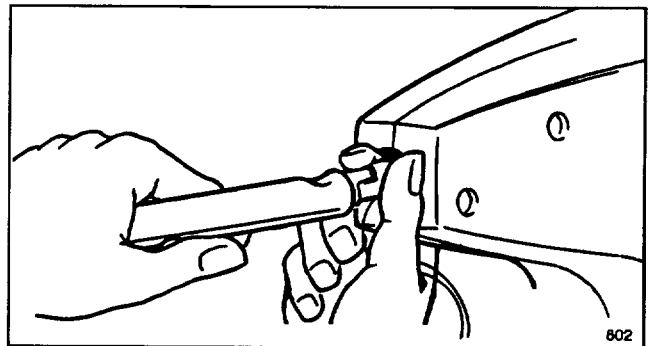

Figure 4

5. After connectors are securely connected, remove hang tag from connector plug (Fig. 2).

6. Grasp handle tube firmly and slide tube into battery housing. Make sure the cutter shield is in the proper operating position. Align screw holes in housing with grooves in tube (Fig. 5).

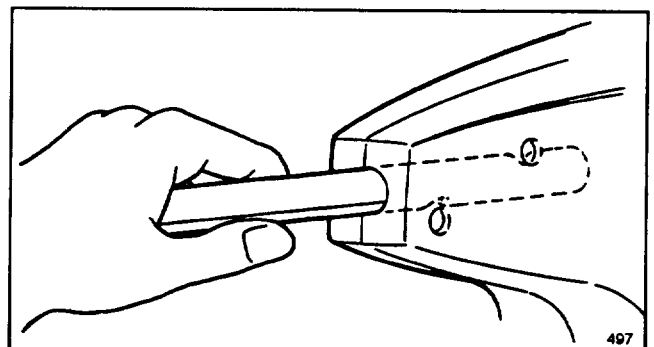

Figure 5

ASSEMBLY INSTRUCTIONS

7. Secure battery housing to tube using the (2) screws and hex nuts supplied (Fig. 6).

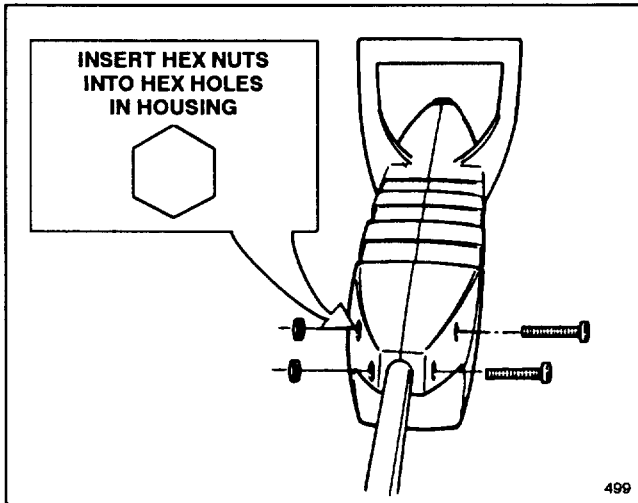

Figure 6

Note: Rear screw installation will be easier if you use a blunt object such as a pencil eraser to hold the rear nut in place while installing the screw.

8. Remove tape from cut-off blade on trimmer head.

CAUTION

- Cutting knife on grass shield is sharp.
- Contact with cutting knife could cause personal injury.
- Be careful when handling shield. Avoid contact with knife blade.

BEFORE OPERATING

CAUTION

- Never use a charger case or cord that is damaged.
- A damaged charger case or cord could cause a shock or fire.
- Thoroughly inspect charger before using. If charger case or cord is damaged, do not use. Replace charger immediately.

connect the charger from the wall outlet and trimmer after the trimmer is fully charged. Do not store the trimmer with the charger plugged in.

3. Do not store trimmer with battery in discharged condition.
4. Store fully charged trimmer in cool, dry location. Do not store trimmer in direct sunlight or near furnace. Storing trimmer in a warm area will decrease life of battery. If trimmer must be stored in a warm area, charge battery for 24 hours every 2–3 months when not in use.

5. **IMPORTANT**—Use only the Toro charger 73–5410 supplied. Using a different charger may damage the battery.

BATTERY CHARGING

Your trimmer arrives with a partially charged battery. Charge your trimmer battery immediately after unpacking and reading your operating instructions. THE BATTERY SHOULD BE CHARGED FOR 24 HOURS BEFORE ITS FIRST USE.

NOTE: Battery may not reach its maximum performance until approximately five full charge–discharge cycles.

TIPS FOR MAXIMIZING BATTERY LIFE AND PERFORMANCE

1. Fully charge your battery immediately after each use (Fig. 7). Charging time of 24 hours will restore a discharged battery.
2. Your Toro trimmer is designed with over charge protection. However, it is recommended that you dis-

BATTERY CHARGING PROCEDURE

WARNING

- Charging produces explosives gases.
- Explosive gases could cause personal injury or property damage.
- Charge battery in a well-ventilated area away from sparks, flames and smoking.

1. Insert charger plug into receptacle located on the bottom of the power case (Fig. 7).

BEFORE OPERATING

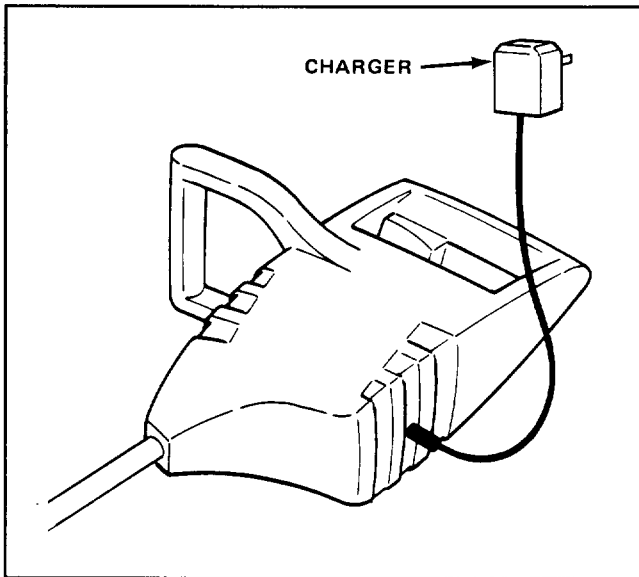

Figure 7

2. Hang trimmer upright from a solid hook (Fig. 8) or lay trimmer on its right side on a flat, solid surface away from combustible liquids, gases or materials. Position trimmer on side as shown in Figure 9.

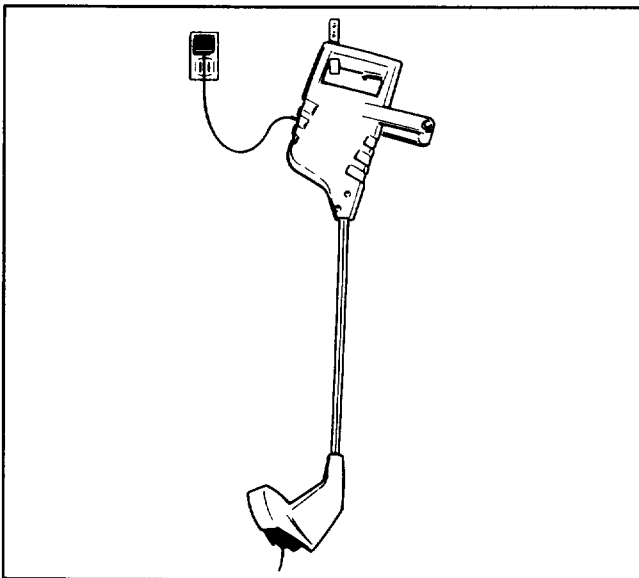

Figure 8

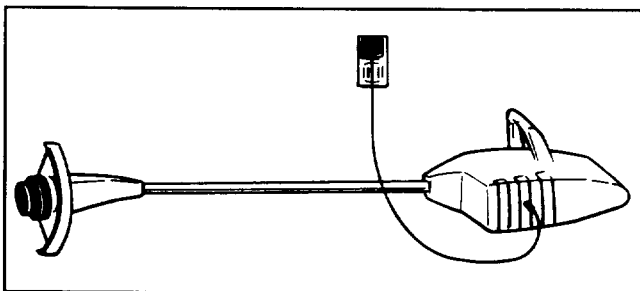

Figure 9

3. Plug charger into 120 volt wall outlet. Be sure outlet is turned on.

NOTE: The charger may become warm to the touch. This is normal and does not indicate a problem.

4. After battery has been properly charged, remove charger from wall outlet then remove charge plug from trimmer receptacle.

CUTTING LINE

NOTE: The cutting line for your trimmer is a special monofilament line. Your trimmer comes complete with a 12 foot supply of this line already wound onto the spool.

1. To avoid line tangle during shipment, the tip of the monofilament line has been taped to the head assembly (Fig. 10). The tape must be removed before operation.

2. After each use, either retaping or looping the line through the eyelet will prevent unraveling of line on spool (Fig. 11).

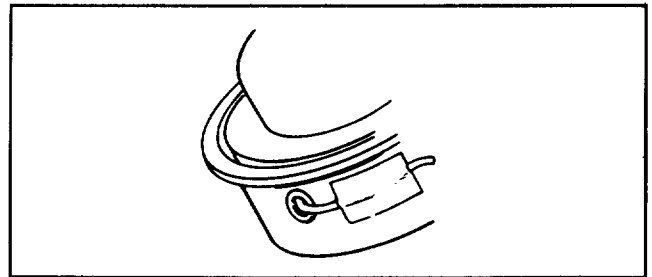

Figure 10

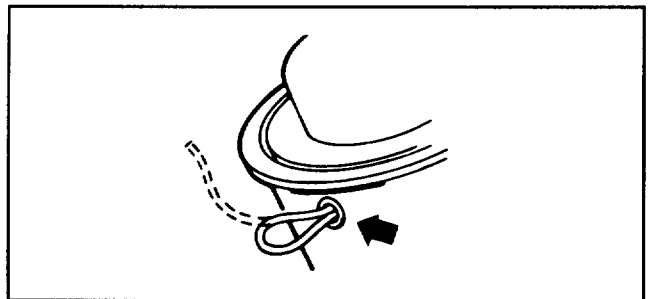

Figure 11

OPERATING INSTRUCTIONS



CAUTION

- Object can be thrown by the trimmer while it is in operation.
- Thrown objects could cause injury to the operator or bystanders.
- Always wear safety goggles or other suitable eye protection, long pants and shoes while operating trimmer.
- Keep people and pets away from trimming area.

1. Inspect area to be trimmed for any wire, cord, or string-like matter which could become entangled in the rotating line.

2. Trim only when grass and weeds are dry.

3. Balance the trimmer in one hand using the U-shaped handle. Operate the trigger release and the switch with the other hand (Fig. 12).

4. To operate the trigger release and switch, press the trigger release down with the thumb and depress the switch on the inside of the handle. With the switch depressed, you may let go of the trigger release and the trimmer will continue to run. The switch must be depressed in order for the trimmer to run.

5. Trimmer will stop seconds after switch is released.

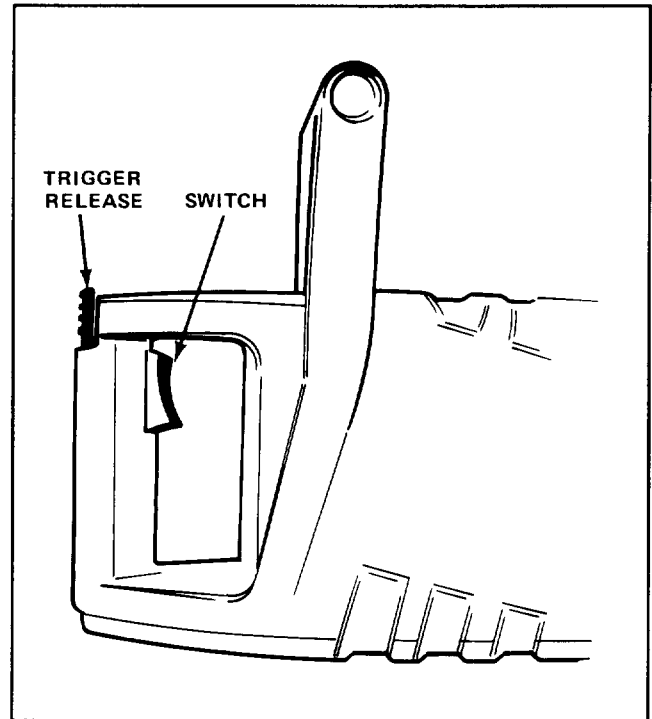

Figure 12



CAUTION

- When trimmer is in operation, the cutting head is rotating.
- Contact with rotating cutting head could cause personal injury.
- Always be sure cutting head has completely stopped rotating before inverting trimmer.

TIPS FOR BEST TRIMMING RESULTS

Your trimmer will cut grass and small weeds in difficult and hard to reach places. However, you will most likely experience some line breakage during your first few uses. As you learn the trimming techniques, you will be able to cut areas around trees, shrubs, foundation walls, fences, sidewalks, patios, etc., with minimal line wear or line breakage.

1. Hold the power pack case in a position which slightly tips cutting head down at an angle to the grass to be trimmed as shown in Figure 14.
2. **DO NOT FORCE THE UNIT.** Allow the very *tip* of the nylon line to do the cutting (especially along walls) (Fig. 13). Cutting with more than the tip will reduce cutting efficiency and overload the motor.

The tip of the cutting line will wear during use and cause a reduction in the cutting swath. If the line is not advanced occasionally, it will wear down to the drum eyelet. When the trimmer is stopped, the line tends to relax and may retract into the drum. Should this occur, be sure to replace the cutting line in the proper position before restarting the trimmer (page 8, step 2D) or the line may tangle around the drum.

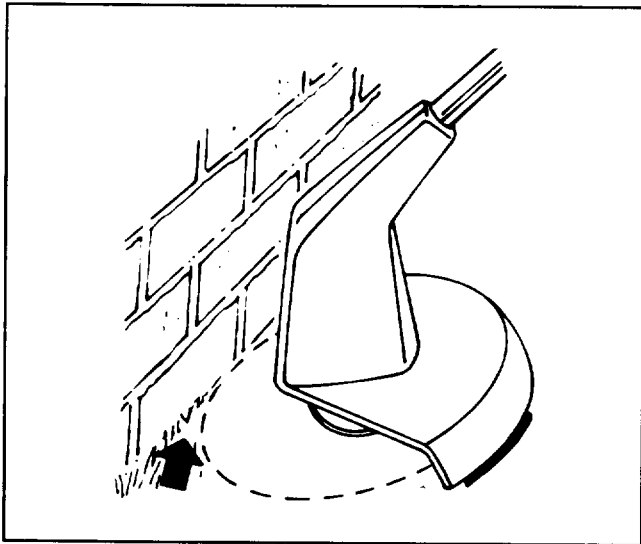

Figure 13

3. Grass over 8 inches tall should be cut by working from the top to the bottom in small increments to avoid premature line wear or motor drag.
4. Whenever possible, cut to your left. When cutting to the left, the unit's cutting efficiency is somewhat better since the line is contacting the grass as soon as it leaves the guard, and the clippings are moving away from the operator.
5. Slowly move the trimmer into and out of the area being cut, maintaining trimmer at desired cutting height. This can be either a forward-backward or

side-to-side motion (Figs. 14 & 15). Maintain top speed for best cutting.

6. Trim only when grass and weeds are dry.
7. The life of your cutting line is dependent upon following the above trimming techniques, as well as what is being cut, and where the cutting is being done. For example, line wears faster when trimming against a foundation wall as opposed to trimming around a tree. Some line breakage will occur from moving unit too fast, from entanglement with foreign matter, from normal line fatigue, and from attempting to cut thick, stalky weeds in excess of the unit's capability. As cutting line wears, for best performance, lengthen as indicated in Lengthening Cutting Line procedure.

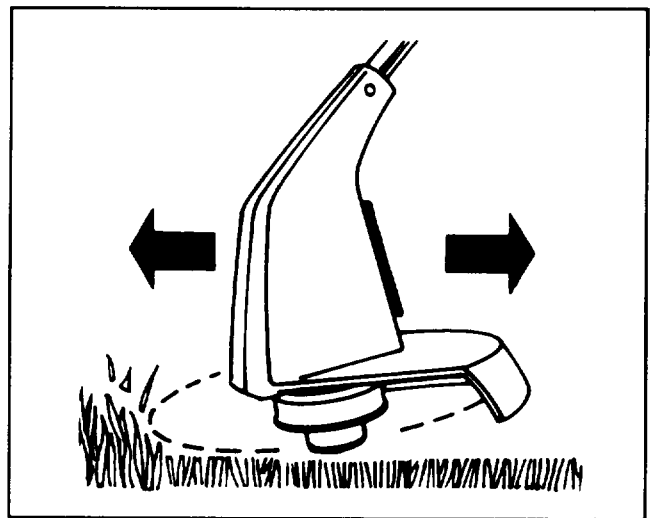

Figure 14

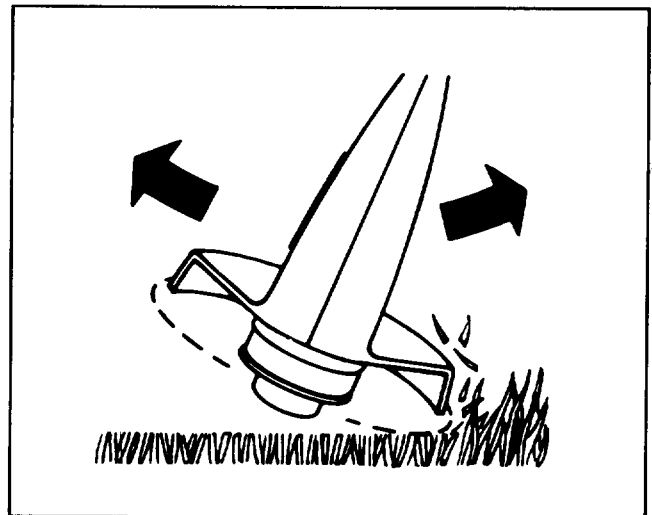

Figure 15

8. **Never drag the trimmer spool cap on the ground while trimming (Fig. 16). This causes unnecessary battery drain and spool cap wear.**

TIPS FOR BEST TRIMMING RESULTS

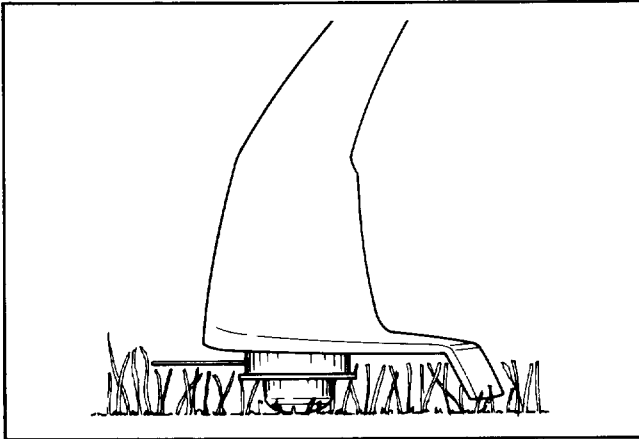

Figure 16

9. After each use, either retape or loop the line through the eyelet (Fig. 11) to prevent unraveling of line.

LENGTHENING CUTTING LINE

1. To lengthen line, firmly tap spool on the ground while the motor continues to run. The line will be fed from the spool and cut off to the proper length by the cutting knife attached to the shield (Fig. 17).

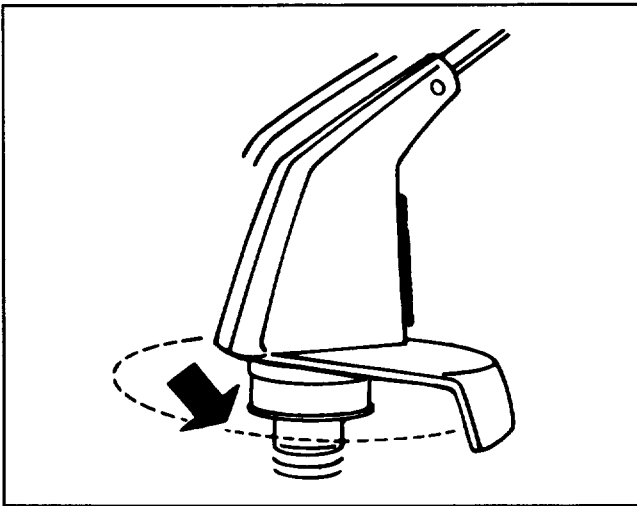

Figure 17

Remember to keep the trimmer running while lengthening the line. Just tap the trimmer on the ground; do not hold it on the ground. After the tap and line has fed out, wait until you hear the line being cut to the proper length before continuing to trim.

Note: To help prevent line tangle, tap once only to lengthen line. If additional line is required, wait a few seconds before retapping trimmer head. Do not allow line to wear too short. Keep line length at 7" diameter as much as possible.

2. Lengthen line only when line has been shortened by wear. Unnecessary lengthening will waste line.

Note: The spool cap may wear during normal use of the line advance feature and may require occasional replacement. Replacement spools are available through your TORO retailer.

REPLACING CUTTING LINE

CAUTION

- Use of improper monofilament line could result in personal injury.
- Do not use any type of wire or other string-like substance.
- Use only TORO .050" dia. nylon monofilament cutting line for best performance.

REPLACING CUTTING LINE

Replacement line or prewound replacement spools can be purchased from your local Toro retailer. The cutting line used by Toro is specially formulated for use on your trimmer. Other line may not provide the same high quality performance.

CAUTION

- When trimmer is in operation, the cutting head is rotating.
- Contact with rotating cutting head could cause personal injury.
- Always be sure cutting head has completely stopped rotating before inverting trimmer.
- Never activate trimmer when it is in an inverted position.

1. (Fig. 18) To remove empty spool, insert widest possible blade screwdriver snugly into one of two window slots on the spool hub. With screwdriver pressed firmly into window slot, twist screwdriver 1/4 turn. Spool will snap off.

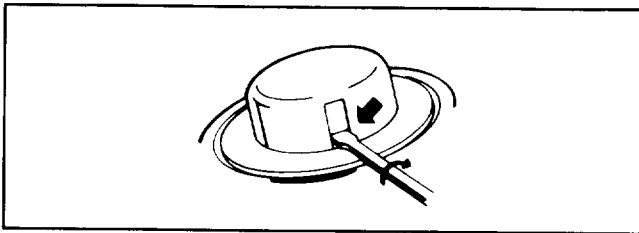

Figure 18

2. To rewind empty spool, follow the steps below:

- A. Hook one end of line into groove on spool, allowing no more than 1/8" to protrude. Wind line in direction of arrows on spool in level rows between spool flanges (Fig. 19).

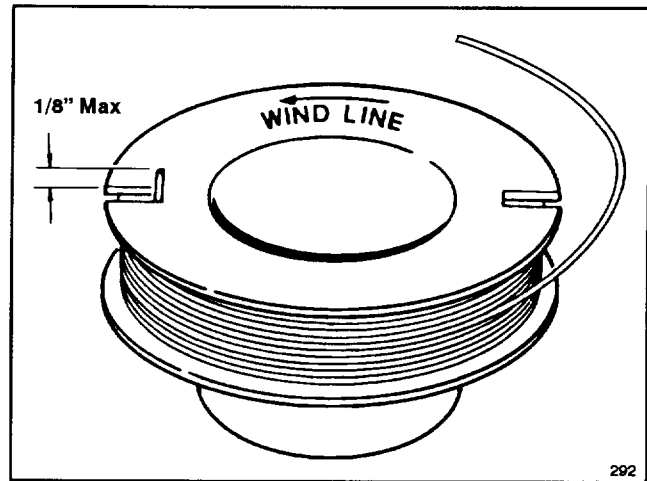

Figure 19

Note: Trimmer will not function properly if line is wound in the wrong direction.

- B. Do not wind more than 12 feet of line onto spool. Do not use line over .050" diameter.
- C. Keep line tight on spool by securing in groove (Fig. 20).

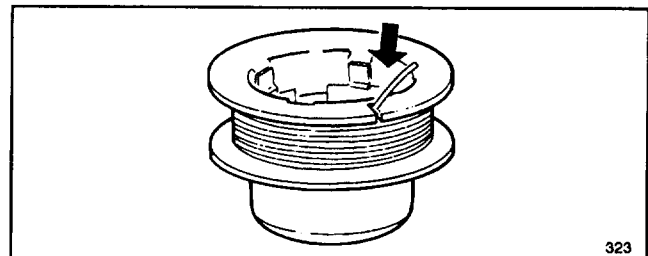

Figure 20

Note: Before assembly, be sure to thoroughly clean out drum area and visually inspect for any damaged or worn parts.

- D. The spool and core are keyed and **must** be properly aligned when putting spool back on. With line still retained in spool groove, thread end of line through eyelet, place spool onto keyed spool core, and push spool inward until you hear it click (Figs. 21 & 22). Pull line to free line from groove in spool. Unwind no more than three inches of line from spool.

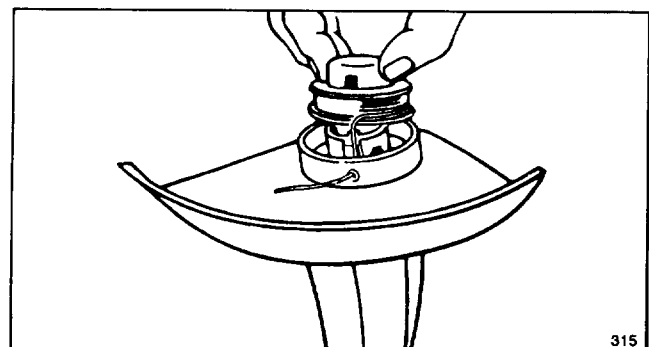

Figure 21

REPLACING CUTTING LINE

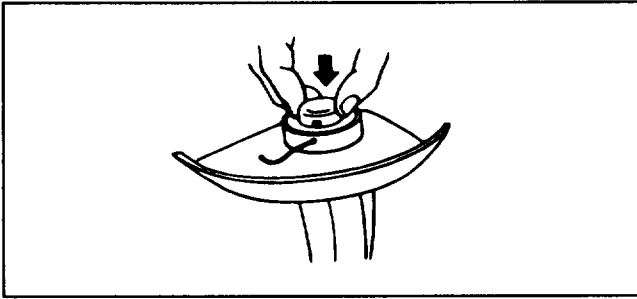

Figure 22

⚠ CAUTION

- A loose spool could fly off the trimmer.
- Contact with a thrown spool could cause injury to the operator or bystanders.
- Be sure spool is fully secured before operating the unit. Replace spool if it is damaged or does not securely snap on core.
- Keep bystanders and pets away from trimming area.

3. If line should tangle or break at eyelet, refeed cutting line through eyelet by pushing spool in as far as it will go and threading line back through eyelet. Or you may remove spool completely, refeed the line through the eyelet, and reassemble spool to trimmer.

BATTERY DISPOSAL INSTRUCTIONS

BATTERY REMOVAL

1. Lay unit on a flat table with screws head in housing facing upwards.
2. Remove (1) self-tapping screw from U-shaped handle. Remove (2) screws and nuts and (5) self-tapping screws from the power pack cover and lift off cover.
3. Lift the battery out of the power pack and disconnect the black and red wires from the battery terminals.

DISPOSING OF BATTERY

When the battery is no longer functional, it must be disposed of properly.

1. DISPOSE OF BATTERY AT AN E.P.A REGISTERED RECLAMATION FACILITY. Check your local telephone directory for the nearest E.P.A REGISTERED RECLAMATION CENTER in your area.
2. IT IS **UNLAWFUL** to dispose of the BATTERY in any landfill. Therefore, **DO NOT** dispose of the BATTERY in any landfill.

HELP US PROTECT THE ENVIRONMENT!

GENERAL MAINTENANCE

⚠ CAUTION

- When trimmer is in operation, the cutting head is rotating.
- Contact with rotating cutting head could cause personal injury.
- Always be sure cutting head has completely stopped rotating before attempting any maintenance.

1. To keep the exterior clean, just wipe it off with a damp cloth. Never hose it down.

2. Wipe or scrape clean the drum and spool area any time there is an accumulation of dirt or cuttings.
3. Make sure battery is fully charged and charger is unplugged from trimmer before storing.
4. Store trimmer in a cool, dry place. Do not store trimmer in direct sunlight or near a furnace. Storing trimmer in a warm area will decrease life of battery. If trimmer must be stored in a warm area, charge the battery for 24 hours every 2–3 months.
5. Check and tighten all fasteners. If any part is damaged, repair or replace it.
6. Any other servicing should be performed by an authorized Toro Service Dealer.

IDENTIFICATION AND ORDERING

The trimmer has two identification numbers: a model number and a serial number. The two numbers are stamped on a decal that is located on handle tube.

In any correspondence concerning the trimmer, supply the model and serial numbers to ensure that correct information and replacement parts are obtained.

To order replacement parts from an Authorized Toro Service Dealer, supply the following information.

1. Model and serial numbers of the trimmer.
2. Part number, description, and quantity of part(s) desired.

Note: Do not order by reference number if a parts catalog is being used; use PART NUMBER.

ACCESSORIES

PART NO.	DESCRIPTION
88075	Prewound Spool
34-9870	Empty Spool
88011	30' Coil—.050" Cutting Line

The Toro Promise

A Full Two Year Residential Use Warranty

The Toro Company warrants this TORO Product for two years against defects in material or workmanship. To receive a replacement or repair, at Toro's option, just return the complete unit, postage prepaid, to the seller or any TORO Electric Service Dealer or the TORO Service Center, 5300 Shoreline Blvd., Mound, MN 55364, along with proof of purchase. This warranty covers product defects only. It does not cover incidental or consequential damages. **Some states do not allow the exclusion or limitation of incidental or consequential damages, so the above limitation may not apply to you.** This warranty gives you specific rights, and you may have other rights which vary from state to state.

COUNTRIES OTHER THAN THE UNITED STATES OR CANADA

Customers who have purchased TORO products exported from the United States or Canada should contact their TORO Distributor (Dealer) to obtain guarantee policies for your country, province, or state. If for any reason you are dissatisfied with your Distributor's service or have difficulty obtaining guarantee information, contact the TORO importer. If all other remedies fail, you may contact us at The Toro Company.