

MODEL NO. 30165-20001 &amp; UP

OPERATOR'S  
MANUAL
**PROLINE 165 MID SIZE**  
Traction Unit

To assure maximum safety, optimum performance, and to gain knowledge of the product, it is essential that you or any other operator of the machine read and understand the contents of this manual before the engine is ever started. Pay particular attention to the SAFETY INSTRUCTIONS highlighted by this symbol —

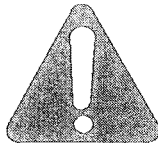

The safety alert symbol means CAUTION, WARNING or DANGER — personal safety instruction. Failure to comply with the instruction may result in personal injury.

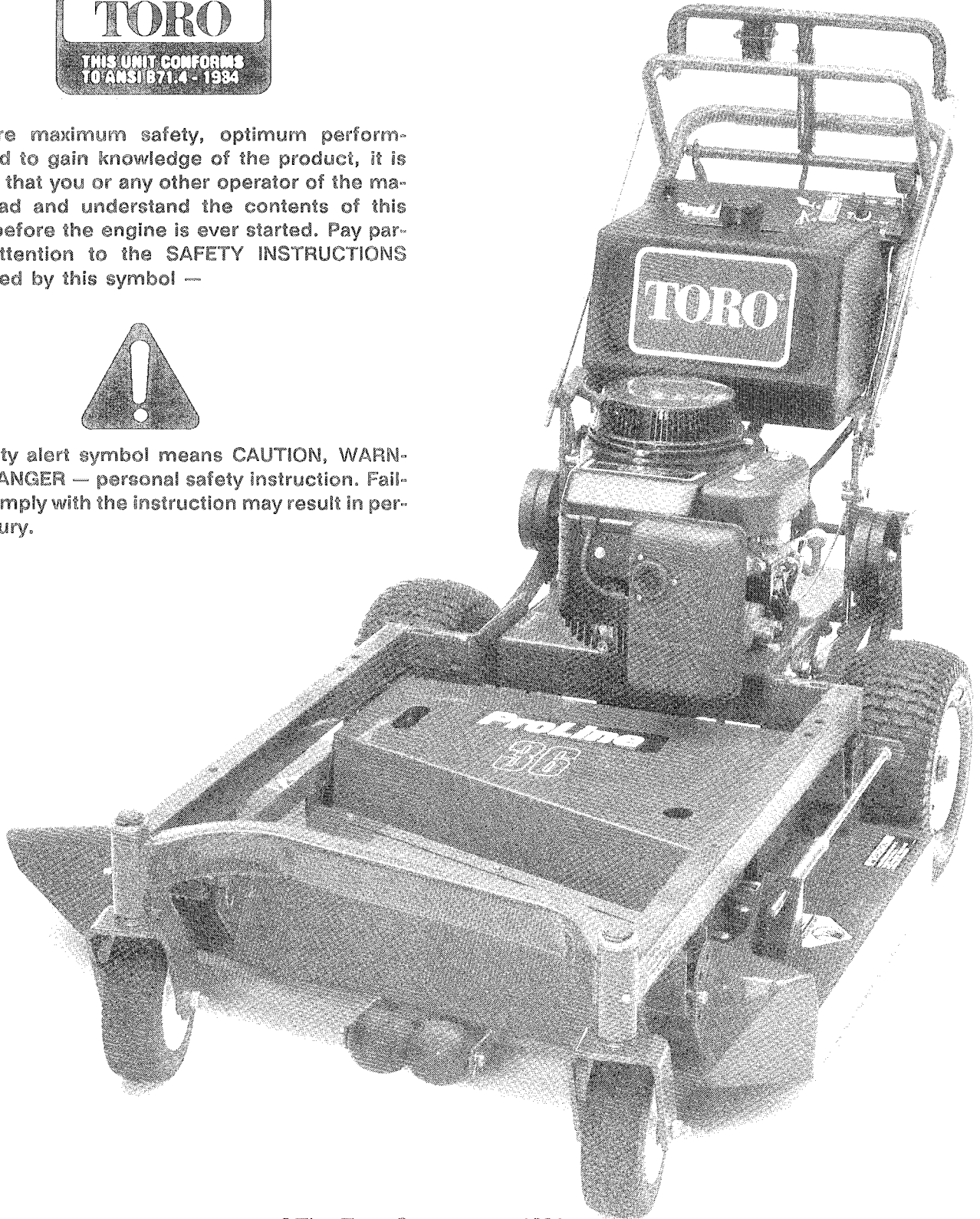

# FOREWORD

The Proline mid size mowers have advanced concepts in engineering, design and safety; and if maintained properly, will give excellent service.

Since this is a high-quality product, Toro is concerned about the future use of the machine and safety of the user. Therefore, read this manual to familiarize yourself with proper set-up, operation and maintenance instructions. The major sections of the manual are:

1. Safety Instructions
2. Set-up Instructions
3. Before Operating
4. Operation
5. Maintenance

Certain information in this manual is emphasized. DANGER, WARNING and CAUTION identify personal safety related information. IMPORTANT identifies mechanical information demanding special attention. Be sure to read this directive because it deals with the possibility of damaging a part or parts of the machine. NOTE identifies general information worthy of special attention.

## TABLE OF CONTENTS

	Page		Page
SAFETY INSTRUCTIONS .....	2	Fuel Filter Replacement .....	11
SAFETY AND INSTRUCTION DECALS .....	4	Replacing Spark Plug .....	12
SPECIFICATIONS .....	4	Adjusting Throttle-Choke Control .....	12
LOOSE PARTS .....	5	Adjusting Carburetor .....	13
SET-UP INSTRUCTIONS .....	5	Adjusting and Replacing Traction Belt .....	13
BEFORE OPERATING .....	8	Adjusting Clutch .....	14
CONTROLS .....	9	Brake Adjustment .....	14
OPERATING INSTRUCTIONS .....	9	Drive Belt Replacement .....	14
MAINTENANCE .....	10	Cleaning Cooling System .....	14
Grease Wheels .....	10	WIRING SCHEMATIC .....	15
Grease Transmission Couplers .....	10	IDENTIFICATION AND ORDERING .....	15
Servicing Air Cleaner .....	10	THE TORO PROMISE .....	Back Cover
Changing Crankcase Oil .....	11		

## SAFETY INSTRUCTIONS

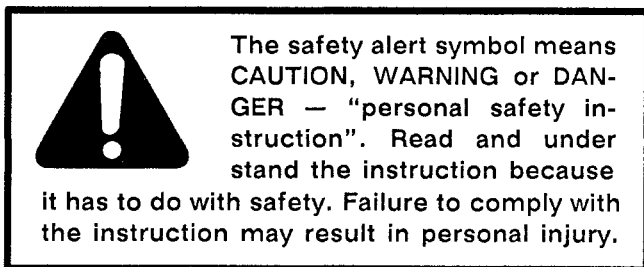

The Proline mid size mower was tested and certified by TORO for compliance with the B71.4 – 1984 specifications of the American National Standard Institute. Hazard control and accident prevention are dependent upon the awareness, concern, and proper training of the personnel involved in the operation, transport, maintenance, and storage of the machine. Improper use or maintenance of the machine can result in injury or death. To reduce the potential for injury or death, comply with the following safety instructions.

**WARNING:** Engine exhaust contains carbon monoxide which is an odorless, deadly poison. Carbon monoxide is also known to the State of California to cause birth defects. Do not run engine indoors or in an enclosed area.

### BEFORE OPERATING

1. Read and understand the contents of this Operator's Manual before operating the machine. Become familiar with all controls and know how to stop quickly. A free replacement manual is available by sending complete Model and Serial Number to:

The Toro Company  
8111 Lyndale Avenue South  
Minneapolis, Minnesota 55420

2. Never allow children to operate the machine. Do not allow adults to operate machine without proper instruction. Only trained operators who have read this manual should operate this machine.

3. Never operate the machine when under the influence of drugs or alcohol.

4. Before attempting to start engine, shift into neutral and lock parking brake.

5. Remove all debris or other objects that might be picked up and thrown by the cutter blades. Keep all bystanders away from the mowing area.

# SAFETY INSTRUCTIONS

6. Keep all shields and safety devices in place. If a shield, safety device or decal is illegible or damaged, repair or replace it before operation is commenced. Also tighten any loose nuts, bolts and screws to assure machine is in safe operating condition.
7. Do not operate machine while wearing sandals, tennis shoes, sneakers or shorts. Also, do not wear loose fitting clothing which could get caught in moving parts. Always wear long pants and substantial shoes. Wearing safety glasses, safety shoes and a helmet is advisable and required by some local ordinances and insurance regulations.
8. Fill fuel tank with gasoline before starting the engine. Avoid spilling gasoline. Since gasoline is flammable, handle it carefully.
  - A. Use an approved gasoline container.
  - B. Do not fill tank while engine is hot or running.
  - C. Do not smoke while handling gasoline.
  - D. Fill fuel tank outdoors and up to about one inch (25 mm) from top of the tank, not the filler neck.
  - E. Wipe up any spilled gasoline.

## WHILE OPERATING

9. Start engine when parking brake is set, blade is disengaged, and transmission is in neutral.
10. Do not run the engine in a confined area without adequate ventilation. Exhaust fumes are hazardous and could possibly be deadly.
11. Using the machine demands attention, and to prevent loss of control:
  - A. Mow only in daylight or when there is good artificial light.
  - B. Watch for holes or other hidden hazards.
  - C. Do not drive close to a sand trap, ditch, creek or other hazard.
  - D. Reduce speed when making sharp turns and when turning on hillsides.
12. The grass deflector must always be installed and in down position on the side discharge cutting unit, except when using the optional grass catcher. This product is designed to drive objects into the ground where they lose energy quickly in grassy areas. However, don't take an injury risk!! When a person or pet appears unexpectedly in or near the mowing area, STOP MOWING. Careless operation, combined with terrain angles, ricochets, or improperly positioned guards, can lead to thrown object injuries. Do not resume mowing until area is cleared. If the cutting unit discharge area ever plugs, shut engine off before removing the obstruction.
13. Never raise the cutting unit while the blades are rotating.
14. If the cutting blades strike a solid object or the machine vibrates abnormally, shut the engine off. Remove spark plug wire from spark plug to prevent possibility of accidental starting. Check cutting unit and traction unit for damage and malfunctioning parts. Repair any damage before restarting the engine and operating the cutting unit. Be sure blades are in good condition and blade bolts are tight.
15. Cut grass slopes carefully. Do not start, stop, or turn suddenly.
16. Do not touch engine or muffler while engine is running or soon after it is stopped. These areas could be hot enough to cause a burn.
17. Before leaving the operator's position — behind handle or leaving mower unattended, shift transmission into NEUTRAL, apply parking brake and shut OFF engine.

## MAINTENANCE

18. Disconnect spark plug wire from spark plug to prevent accidental starting of the engine when servicing, adjusting or storing the machine.
19. If traction unit and mower must be tipped to perform maintenance or an adjustment, drain gasoline from fuel tank and oil from crankcase.
20. When driving unit forward, always use upper "Forward" traction drive handle. When backing up, always use lower "Reverse" traction drive handle.
21. To reduce potential fire hazard, keep the engine free of excessive grease, grass, leaves and accumulations of dirt.
22. Be sure machine is in safe operating condition by keeping nuts, bolts and screws tight. Check the blade mounting bolts and nuts frequently to be sure they are tightened to specification.
23. If the engine must be running to perform a maintenance adjustment, keep hands, feet, clothing and other parts of the body away from the cutting unit blades and other moving parts.
24. Do not overspeed the engine by changing governor settings. To be sure of safety and accuracy, have an Authorized TORO Proline Service Dealer check maximum engine speed with a tachometer.
25. Engine must be shut off before checking oil or adding oil to the crankcase.
26. Allow engine to cool before storing mower in any enclosure such as a garage or storage shed. Make sure the mower fuel tank is empty if machine is to be stored in excess of 30 days. Do not store mower near any open flame or where gasoline fumes may be ignited by a spark. Always store gasoline in a safety-approved, red metal container.

# SAFETY INSTRUCTIONS

27. Perform only those maintenance instructions described in this manual. If major repairs are ever needed or assistance is desired, contact an Authorized Toro Proline Service Dealer. To ensure optimum performance and safety, always purchase genuine TORO replacement parts and accessories to keep the Toro

all TORO. NEVER USE "WILL-FIT" REPLACEMENT PARTS AND ACCESSORIES MADE BY OTHER MANUFACTURERS. Look for the TORO logo to assure genuineness. Using unapproved replacement parts and accessories could void the warranty of The Toro Company.

## SAFETY AND INSTRUCTION DECALS

The following decals are installed on the machine. If any become damaged or illegible, replace it. The decal part number is listed below and in your parts catalog. Replacement can be ordered from your Authorized Toro Distributor.

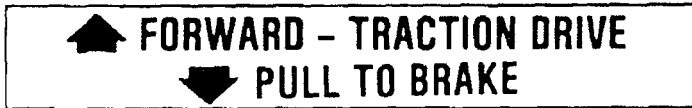

ON UPPER CONTROL BAR  
(Part No. 82-2290)



ON LOWER CONTROL BAR  
(Part No. 82-2280)

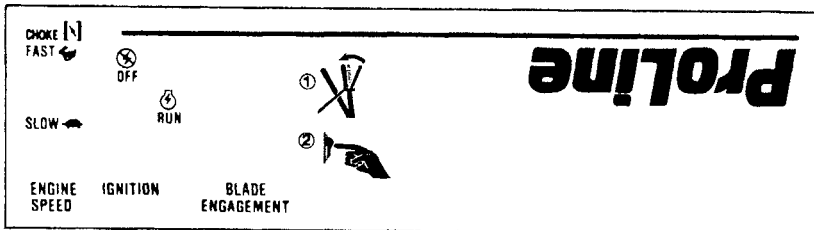

ON CONTROL PANEL  
(Part No. 82-7730)



ON CONTROL PANEL  
(Part No. 71-1280)

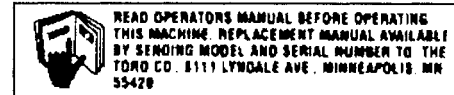

ON CONTROL PANEL  
(Part No. 65-3090)

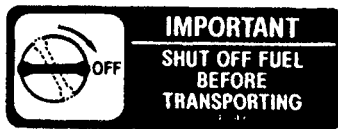

ON REAR FRAME  
(Part No. 74-0490)

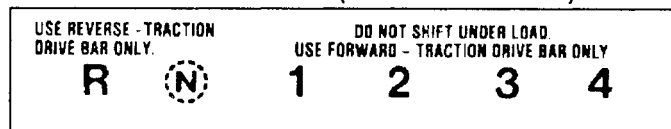

ON CONTROL PLATE  
(Part No. 82-7750)

## SPECIFICATIONS

**12.5 hp Kawasaki Engine:** four cycle, recoil start with automatic compression release, vertical shaft engine has output of 12.5 hp @ 3600 RPM and 20.1 ft-lb torque @ 2300 RPM. Displacement is 28.1 cubic inches. Crankcase oil capacity is 48 ounces and fuel tank capacity is 5 gallons. Correct spark plug is NGK BMR-4A, Champion RCJ-8 or equivalent. Spark arrester muffler.

**Frame:** 11 ga. formed steel box with 1 in. dia. axle with 1/4" x 4 U-strap rear frame bolted to frame.

**Wheels and Tires:** 6.5 x 13 pneumatic tires are mounted on welded steel wheels which have greaseable ball bearings. Recommended tire pressure is 15 psi.

**Transmission:** Permanently lubricated and fully enclosed gear box. In line shift pattern with 4 forward speeds, neutral and reverse.

**Traction Drive Belts:** A-section, V-belt with 3 in. dia. take up idler to gear box from engine. 2 rib A-section banded belt to each wheel from gear box output shafts.

### Gear Drive Reduction:

- 1st gear - 7.0
- 2nd gear - 4.5
- 3rd gear - 3.5
- 4th gear - 3.0
- Rev. - 6.0

### Ground Speed @ 3200 Engine rpm:

- 1st gear - 1.9 MPH
- 2nd gear - 3.0 MPH
- 3rd gear - 3.9 MPH
- 4th gear - 4.5 MPH
- Rev. - 2.2 MPH

### Optional Accessories:

- Sulky attachment, Model #30122
- Sulky attachment, Model #30123
- Lift Kit #84-5010

\* Lift kit changes height-of-cut range from 1"- 4" to 2"- 5". The larger tires included in kit will also increase ground speed. Lift kit cannot be used with a model 30136, 36" Deck.

Specifications and design subject to change without notice.

# LOOSE PARTS

**NOTE:** Use this chart as a checklist to assure all parts have been received. Without these parts, total set-up cannot be completed.

Description	Qty.	Use
Upper Handle Flange Capscrew 3/8 - 16 X 1" Lg. Flangenut 3/8-16	1 4 4	Install Upper Handle To Frame.
Shift Lever Shift Lever Mounting Block Plain Washer Capscrew 1/4 - 28 X 2" Lg.	1 1 1 1	Install Shift Lever To Transmission
Rod Fitting Clevis Pin Washer Hairpin Cotter	2 2 2 2	Install Control Rods
Fuel Tank Control Panel Capscrew 5/16 - 18 X 7/8" Lg. Lockwasher 5/16 Flatwasher 5/16 Hose Clamp	1 1 4 4 2	Install Fuel Tank And Control Panel
Cable Ties	1	Connect Wire Harness
Operator's Manual Parts Catalog Registration Card	1 1 1	Read Before Operating Machine Fill Out And Return To Toro

## SET-UP INSTRUCTIONS

### MOUNT FUEL TANK AND CONTROL PANEL

1. Position fuel tank onto rear frame aligning mounting holes as shown in Fig. 1.

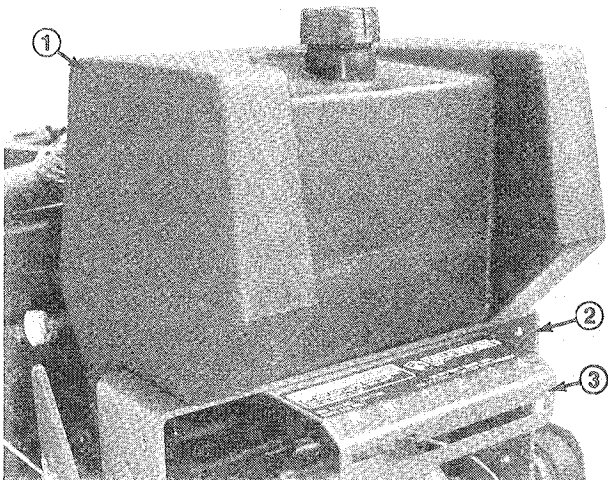

**Figure 1**

1. Fuel tank
2. Rear frame
3. Control panel

2. Loosely mount control panel to bottom of rear frame and fuel tank with (4) capscrews, lockwashers and washers (Fig. 1 & 2). Do not tighten capscrews at this time.

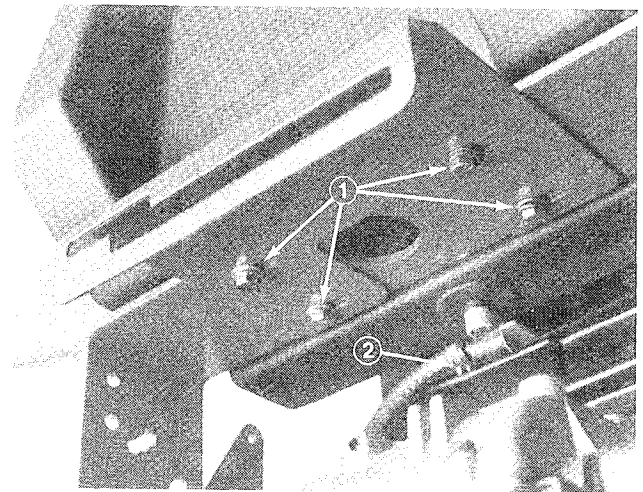

**Figure 2**

1. Capscrews, lockwashers & washers
2. Fuel line hose clamps

3. Secure fuel line to tank fitting with hose clamp (Fig. 2).

### INSTALL SHIFT LEVER

1. Position shift lever mounting block onto shaft on top of transmission. **DO NOT** remove rubber washer on transmission.

# SET-UP INSTRUCTIONS

2. Insert shift lever thru slot in control panel and align mounting hole in lever with mounting block on transmission. Secure lever to transmission with 1/4-28 x 2" lg. capscrew and plain washer. Torque capscrew to 100-125 in - lb (Fig. 3).

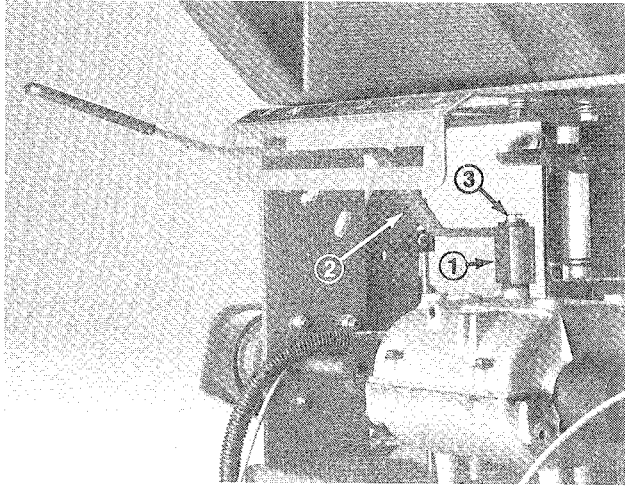

**Figure 3**

1. Shift lever mounting block
2. Shift lever
3. Capscrew & washer

3. Move shift lever to reverse and 4th gear. Control panel mounting holes are slotted to enable it to be moved from side to side (Fig. 2). Position control panel as needed to achieve full shift range. Tighten mounting screws to a maximum of 90 in - lb. **DO NOT OVER TIGHTEN.**

## INSTALL UPPER HANDLE

1. Align upper handle mounting holes with desired mounting holes in frame (upper or lower set of holes) and secure each side with (2) 3/8 -16 x 1" lg. flange capscrews and flange nuts (Fig. 4). Route cables and wire harness inside of frame (Fig. 4)

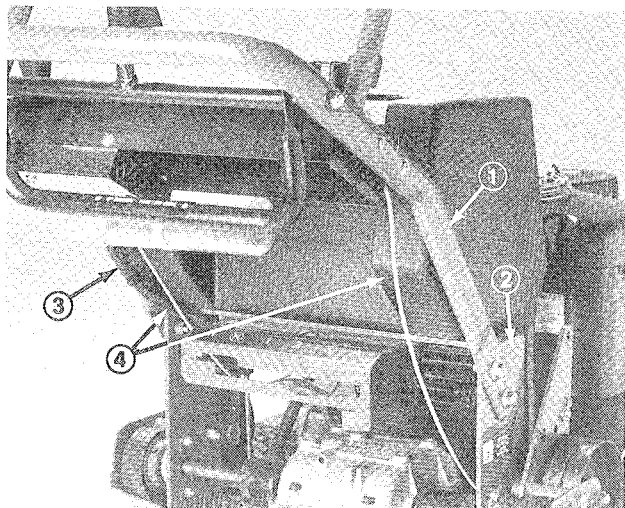
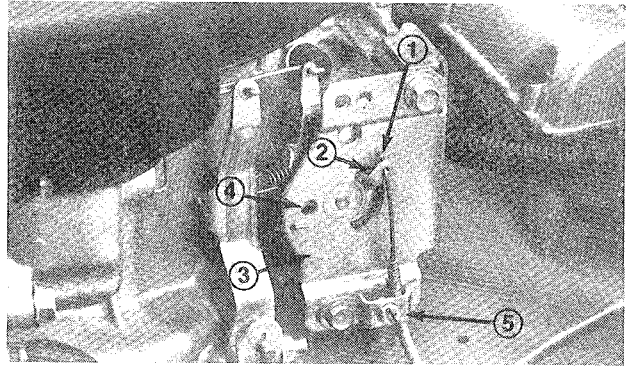

**Figure 4**

1. Upper handle
2. Frame
3. Wire harness
4. Cables

## CONNECT THROTTLE CABLE

1. Place throttle control lever in FAST position.
2. Hook wire Z-bend into hole of speed control lever (Fig. 5).



**Figure 5**

1. Wire Z-bend
2. Speed control lever
3. Base plate
4. Aligned holes
5. Cable clamp

3. Loosen cable clamp screw allowing cable installation, but do not tighten (Fig. 5).

4. Move control cable casing and wire until hole in speed control lever is aligned with hole in base plate. Insert a small dia. pin (1/4") or bolt into aligned holes to hold adjustment.

5. Pull throttle cable slightly to remove any slack and tighten cable clamp screw to lock adjustment in place.

6. Remove alignment pin and check control operation. Refer to Adjusting Throttle - Choke Control, page 12.

## CONNECT WIRE HARNESS

1. Secure clutch and engine in-line wire connectors (Fig. 6).

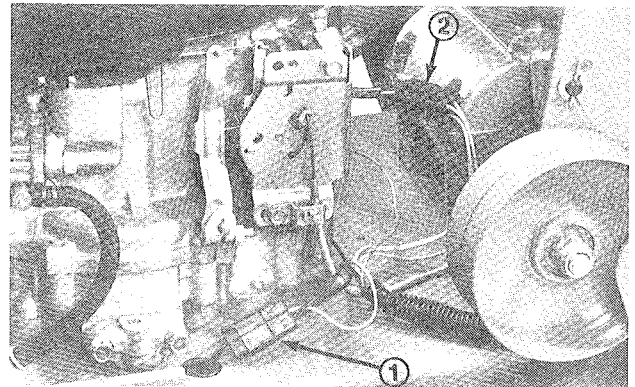

**Figure 6**

1. Clutch wire connectors
2. Engine wire connectors

2. Remove top jam nut from right rear engine mounting bolt located behind oil dipstick.

# SET-UP INSTRUCTIONS

3. Mount remaining wire to engine bolt and secure with jam nut.
4. Secure wire harness to fuel line (above filter) with a cable tie.

## INSTALL CONTROL RODS

1. Thread a rod fitting onto each control rod approximately 2" (Fig. 7) or until upper control bar (Fig. 8) is approximately perpendicular to the ground.
2. Mount rod fitting ends to mounting holes in idler brackets (from outside) with clevis pins, washers and hairpin cotters (Fig. 7).

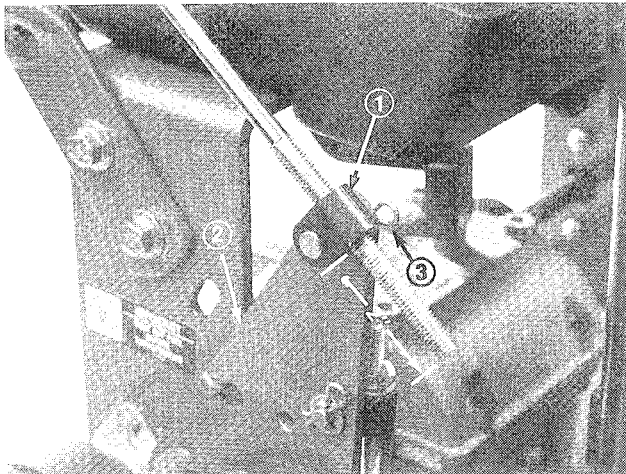

**Figure 7**

1. Control rod fitting
2. Idler brackets
3. Clevis pin, washer & hairpin cotter

3. Check gap between upper control bar and upper handle when fully engaging wheel belts. Gap should be approximately 1 to 1-1/4" (Fig. 8).

**Note:** The control bar and upper handle must be parallel when in relaxed drive and brake positions.

4. Check operation. If adjustment is required, remove hairpin cotter and washer securing end of control rod to upper control bar, thread rod into or out of rod fitting to proper position and reinstall to upper control bar with washer and hairpin cotter.

5. Brake rods should be adjusted so parking brake lever can be swung into a snug position against the upper handle while pulling back on upper control bar (Fig. 8).

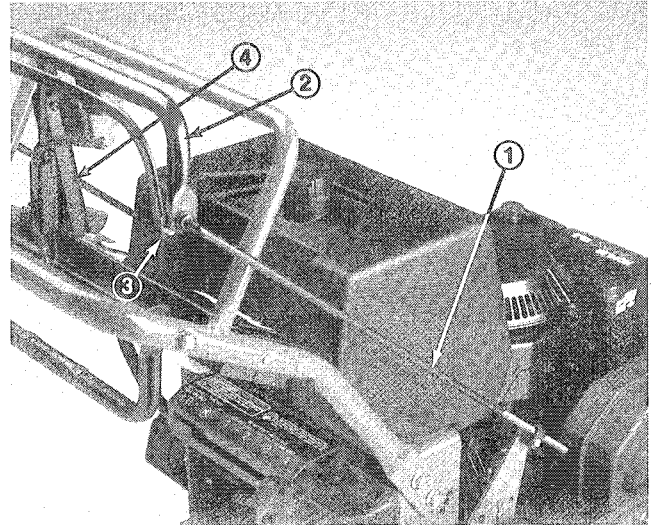

**Figure 8**

1. Control rod
2. Upper control bar
3. Washer & hairpin cotter
4. Parking brake lever

6. If an adjustment to brake rods is required, remove hairpin cotter and washer securing brake rod fitting to idler bracket (Fig. 9).

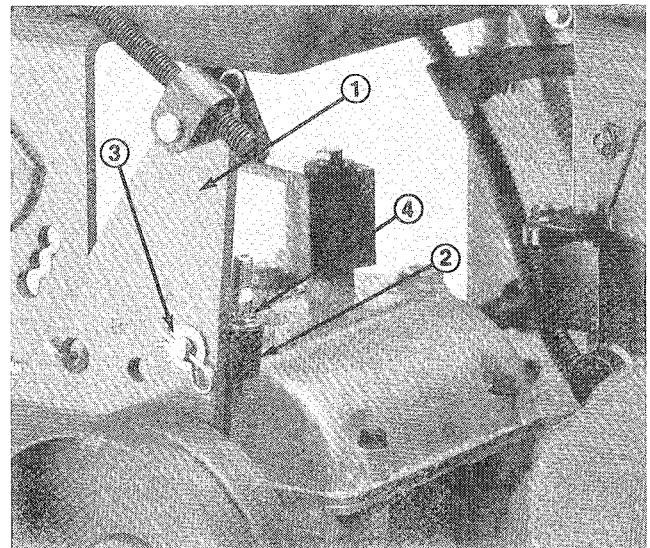

**Figure 9**

1. Idler bracket
2. Brake rod fitting
3. Hairpin cotter & washer
4. Wing nut

7. Adjust wing nut up or down on brake rod and re-secure to idler bracket. Check adjustment and readjust if necessary.

**Note:** Make sure brake rod is installed in forward ("F") mounting hole in idler bracket.

8. Repeat procedure on opposite side if adjustment is required.

# BEFORE OPERATING

## FILL CRANKCASE WITH OIL

The engine does not have oil in the crankcase when it is shipped from the factory. If engine is started before oil is added to the crankcase, engine damage could result. Therefore, before engine is started for the first time:

1. Position mower on level surface.
2. Clean area around the oil dipstick to prevent foreign matter from entering the filler hole when dipstick is removed.
3. Remove dipstick (Fig. 10).

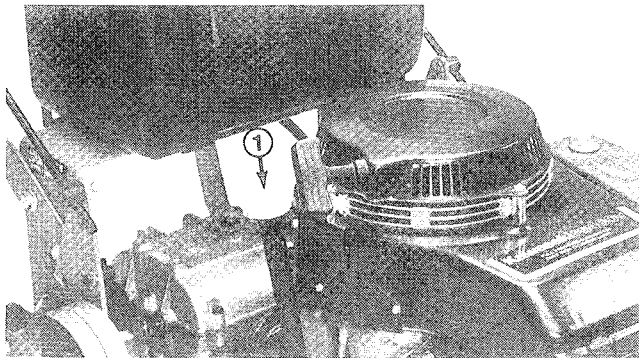

Figure 10

1. Dipstick

4. Slowly pour approximately 48 ounces of oil into the filler neck. The engine uses any high quality detergent oil having the American Petroleum Institute —API— “service classification” SF, SE/CC, CD or SE. The recommended oil to use is: SAE 5W20 or 5W30 (below 32° F) or SAE 30 (above 32° F).

5. Wipe end of dipstick with clean rag and insert it into filler neck. Then remove the dipstick and check level of oil by reading the dipstick (Fig. 10). If level of oil is low, add only enough oil to raise level to FULL mark on dipstick. **DO NOT ADD OIL SO LEVEL RISES ABOVE FULL MARK BECAUSE ENGINE COULD BE DAMAGED WHEN IT IS STARTED.**

6. Insert dipstick into filler neck and tighten.

**Note:** Check level of oil after every 5 operating hours or each time the mower is used. Initially, change oil after the first 5 hours of operation; thereafter, when conditions are normal, change oil after every 25 hours of operation. However, change oil more frequently when mower is operated in dusty or dirty conditions.

## CHECK TIRE PRESSURE

Tires are over inflated at the factory. Check tires and insure they are inflated to 15 psi.

## FILL FUEL TANK WITH GASOLINE

THE TORO COMPANY STRONGLY RECOMMENDS THE USE OF FRESH CLEAN, UNLEADED REGULAR GRADE GASOLINE IN TORO GASOLINE POWERED PRODUCTS. UNLEADED GASOLINE BURNS CLEANER, EXTENDS ENGINE LIFE, AND PROMOTES GOOD STARTING BY REDUCING THE BUILD-UP OF COMBUSTION CHAMBER DEPOSITS.

**NOTE:** NEVER USE METHANOL, GASOLINE CONTAINING METHANOL, GASOLINE CONTAINING MORE THAN 10% ETHANOL, GASOLINE ADDITIVES, PREMIUM GASOLINE, OR WHITE GAS BECAUSE ENGINE FUEL SYSTEM DAMAGE COULD RESULT.

1. Clean area around fuel tank cap and remove cap from tank.
2. Fill fuel tank to about 1 inch from top of the tank, not filler neck. Install fuel tank cap securely.
3. Wipe up spilled gasoline.



**DANGER**

Because gasoline is flammable, caution must be used when storing or handling it. Do not fill fuel tank while engine is running, hot or when machine is in an enclosed area. Vapors may build up and be ignited by a spark or flame source many feet away. **DO NOT SMOKE** while filling the fuel tank to prevent the possibility of an explosion. Always fill fuel tank outside and wipe up any spilled gasoline before starting engine. Use a funnel or spout to prevent spilling gasoline before starting engine and fill tank to about 1 inch from top of tank, not filler neck. Store gasoline in a clean safety-approved container and keep the cap in place on the container. Keep gasoline in a cool, well-ventilated place; never in an enclosed area such as a hot storage shed. To assure volatility, do not buy more than a 30 day supply of gasoline. Gasoline is a fuel for internal combustion engines; therefore, do not use it for any other purpose. Since many children like the smell of gas, keep it out of their reach because the fumes are explosive and dangerous to inhale.

# CONTROLS

**Throttle Control (Fig. 11)** – The throttle control has three positions: CHOKE, FAST and SLOW.

**Deck Engagement Control Bail (Fig. 11)** – Control bail used in conjunction with deck engagement switch to release blade brake and engage electromagnetic clutch to drive deck pulleys. Release bail to disengage deck pulleys.

**Deck Engagement Switch (Fig. 11)** – Rocker switch used in conjunction with control bail to release blade brake and engage electromagnetic clutch to drive deck pulleys.

**Gear Shift Lever (Fig. 11)** – Transmission has four forward speeds, neutral and reverse, and has an in-line shift pattern. Do not shift while unit is moving, as transmission damage may occur.

**Upper Control Bar (Fig. 11)** – Shift to desired gear and push forward on control bar to engage forward traction operation and pull back to brake. Pull right side of control bar to turn right and left side to turn left.

**Lower Control Bar (Fig. 11)** – Shift transmission to reverse and pull rearward on lower control bar to engage rearward traction operation.

**Parking Brake Lever (Fig. 11)** – Pull back on upper control bar and swing brake lever up against the upper handle.

**Ignition Switch (Fig. 11)** – Key switch is used in conjunction with recoil starter. Switch has two positions: RUN and OFF.

**Recoil Starter** – Pull recoil Starter handle to start engine.

**Fuel Shut-off Valve** – (Under fuel tank) Close fuel shut-off valve when transporting or storing mower.

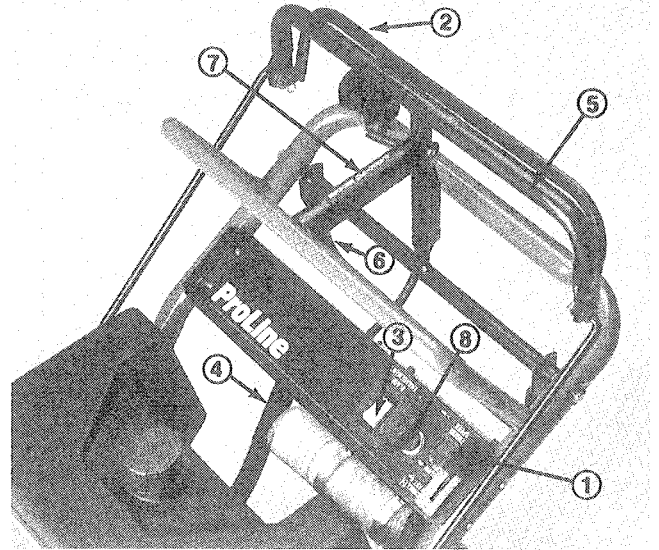

Figure 11

- |                                 |                        |
|---------------------------------|------------------------|
| 1. Throttle control             | 5. Upper control bar   |
| 2. Deck engagement control bail | 6. Lower control bar   |
| 3. Deck engagement switch       | 7. Parking brake lever |
| 4. Gear shift lever             | 8. Ignition switch     |

# OPERATING INSTRUCTIONS

## STARTING AND STOPPING

1. Make sure spark plug wire is installed on spark plug and fuel valve is open.
2. Shift into neutral and turn ignition key to RUN.
3. Move throttle control to CHOKE position before starting a cold engine.

**Note:** A warm or hot engine usually does not require any choking. To start a warm engine, move throttle control to FAST position.

4. Grasp recoil starter handle firmly and pull out until positive engagement results; then pull handle vigorously to start engine and allow rope to recoil slowly.

**IMPORTANT:** Do not pull recoil rope to its limit or let go of the starter handle when rope is pulled out because rope may break or recoil assembly may be damaged.

5. To engage blade, squeeze deck engagement control bail against upper control bar and press rocker switch forward. Hold control bail against control bar while operating. Releasing control bail disengages deck pulleys. Repeat procedure to engage deck pulleys if control bail is released.

6. To stop engine, release control bail and control bar, shift to Neutral, move throttle to SLOW and turn ignition key to OFF. Wait for all parts to stop moving before leaving the operating position behind handle.

7. Pull wire off spark plug to prevent possibility of accidental starting before storing machine.

8. Close fuel shut off valve before storing machine.

**IMPORTANT:** Make sure fuel shut off valve is closed before transporting or storing machine, as fuel leakage may occur.

# MAINTENANCE

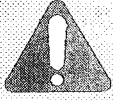

## CAUTION

To prevent accidental starting of the engine while performing maintenance, shut engine off. Also, pull wire off spark plug (Fig. 12). Make sure wire does not contact plug accidentally.

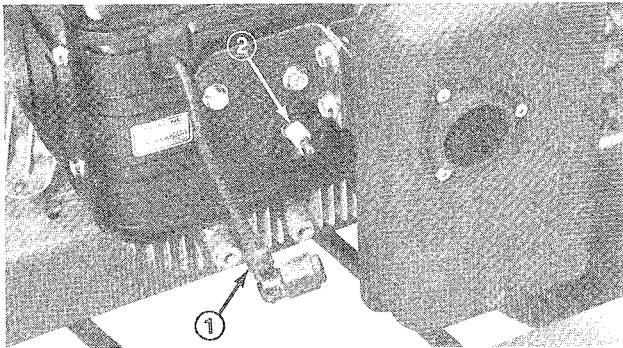

Figure 12

1. Spark plug wire

2. Spark plug

## GREASE WHEELS

Lubricate the wheel bearings every 8 hours with No. 2 general purpose grease. Wipe up any excess grease.

## GREASE TRANSMISSION COUPLERS

Lubricate the transmission couplers (Fig. 13) every 250 hours with No. 2 general purpose grease. Pump grease gun about 4 times. Wipe up any excess grease.

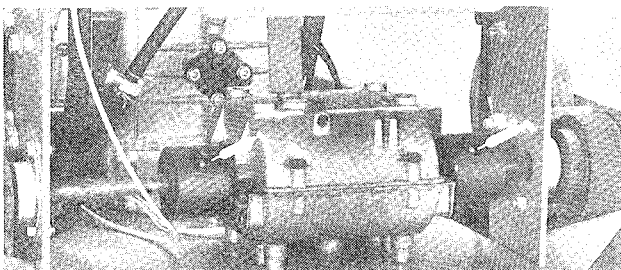

Figure 13

## SERVICING AIR CLEANER

The foam air cleaner element must be cleaned after every 25 hours engine operation if engine is operated in clean air conditions. The paper element must be cleaned or replaced after every 50 hours engine operation if engine is operated in clean air conditions. However, elements must be cleaned every few hours if operating conditions are extremely dusty or sandy. Replace paper element yearly.

1. Remove (2) wing bolts and lift off air cleaner cover (Fig. 14).

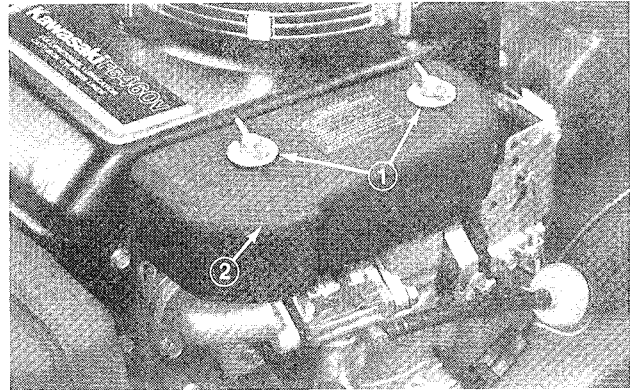

Figure 14

1. Wing bolts  
2. Cover

2. Remove foam pre-cleaner by sliding it off the paper element (Fig. 15).

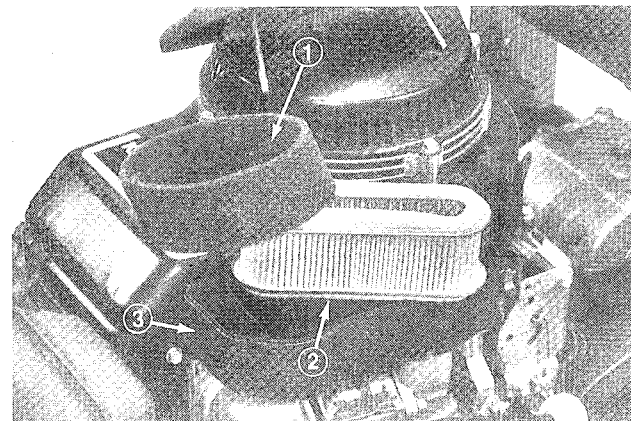

Figure 15

1. Foam element  
2. Paper element  
3. Air cleaner body

3. a. Wash foam pre-cleaner in detergent and warm water.

b. Wrap foam pre-cleaner in cloth and squeeze dry. Do not wring pre-cleaner.

c. Saturate foam pre-cleaner in engine oil. Squeeze to remove excess oil.

4. Remove paper element and clean air cleaner body carefully to prevent dirt from entering carburetor.

5. Clean paper element by tapping gently on a flat surface.

a. If very dirty, replace cartridge or wash in a low or non-sudsing detergent and warm water solution.

b. Rinse thoroughly from OUTSIDE IN until water is clear.

c. Cartridge must be allowed to stand and air dry thoroughly before using.

6. Reassemble air cleaner components.

# MAINTENANCE

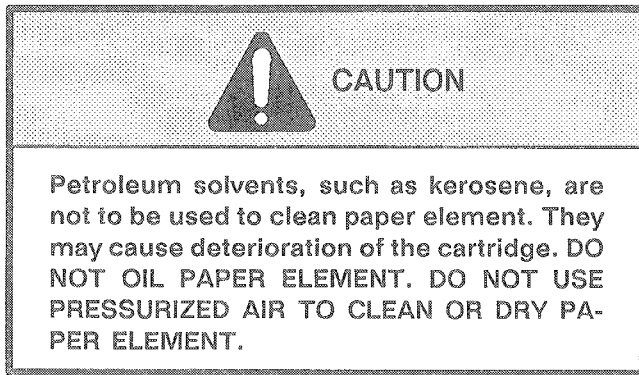

**IMPORTANT:** Always operate engine with air cleaner elements in place or engine damage will result.

## CHANGING CRANKCASE OIL

1. Check level of oil before starting engine and after every 5 hours of operation. Maintain oil level at FULL mark on dipstick.

To check level of oil:

- Position mower on level surface.
- Clean the area around oil dipstick so foreign matter cannot enter filler hole when dipstick is removed.
- Remove dipstick and wipe oil off with a clean rag.
- Insert dipstick. Let dipstick cap threads rest on top of tube. Do not screw dipstick in.
- Remove dipstick and check oil level. If level is low, add only enough oil to raise level to FULL mark. Do not overfill or engine damage may result.
- Insert dipstick back into filler neck.

2. Change oil after first 5 hours of operation; every 25 hours thereafter. Change oil more frequently when operating conditions are extremely dusty or dirty.

To change oil:

- Position mower on level surface. Start and run engine for a period to warm the oil.
- Turn engine off and place drain pan under frame, below drain plug (Fig. 16). Remove drain plug and allow all oil to flow into drain pan. Install drain plug after oil stops flowing.

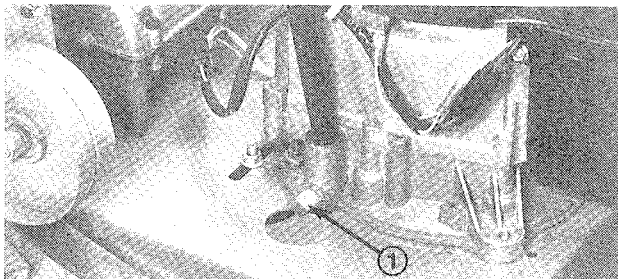
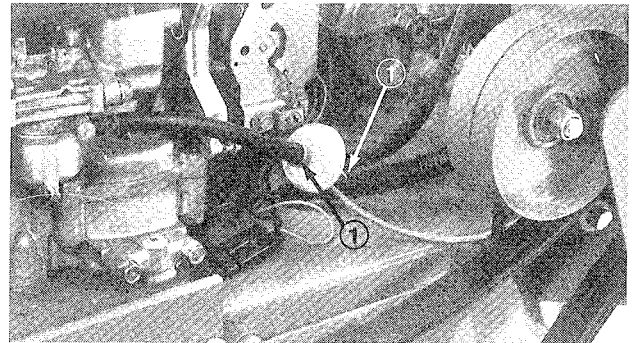

**Figure 16**  
1. Drain plug

c. Remove dipstick and add oil to crankcase. The engine uses any high quality detergent oil having the American Petroleum Institute —API— “service classification” SF, SE/CC, CD or SE. The recommended oil to use is: SAE 5W20 (below 32° F) or SAE 30 (above 32° F). Capacity of crankcase is 48 oz. **DO NOT OVERFILL** or engine damage may result.

## FUEL FILTER REPLACEMENT

An in-line filter is incorporated into the fuel line between the fuel tank and carburetor (Fig. 17). Use the following procedures should replacement become necessary:



**Figure 17**

1. Fuel filter                      2. Hose clamps

- Close fuel shut off valve, loosen the hose clamp on the carburetor side of filter and remove the fuel line from the filter.
- Place a drain pan under filter, loosen the remaining hose clamp and remove filter.

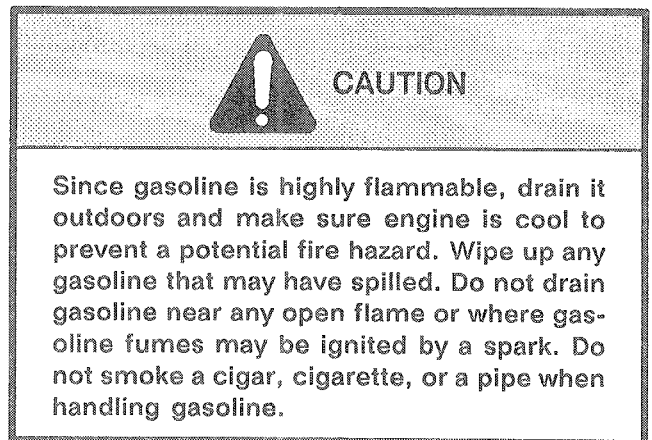

- Install the new filter with arrow on the filter body pointing towards the carburetor.

# MAINTENANCE

## REPLACING SPARK PLUG

Since air gap between center and side electrodes of the spark plug increases gradually during normal operation of the engine, check condition of electrodes after every 25 operating hours. Recommended air gap is 0.024–0.027 of an inch (0.6–0.7 mm). Correct spark plug to use is:

NCK BMR-4A or Champion RCJ-8.

**Note:** The spark plug usually lasts a long time; however, the plug should be removed and checked whenever the engine malfunctions.

1. Clean area around spark plug so foreign matter cannot fall into cylinder when spark plug is removed.
2. Pull spark plug wire off spark plug and remove plug from cylinder head.
3. Check condition of side electrode, center electrode, and center electrode insulator to assure there is no damage.

**IMPORTANT:** A cracked, fouled, dirty or otherwise malfunctioning spark plug must be replaced. Do not sand blast, scrape, or clean electrodes by using a wire brush because grit may eventually release from the plug and fall into the cylinder. The result is usually a damaged engine.

4. Set air gap between center and side of electrodes at 0.024–0.027 of an inch (0.6–0.7 mm (Fig. 18)). Install correctly gapped spark plug w/gasket seal, and tighten plug to 18 ft–lb (24.4 Nm). If torque wrench is not used, tighten plug firmly.

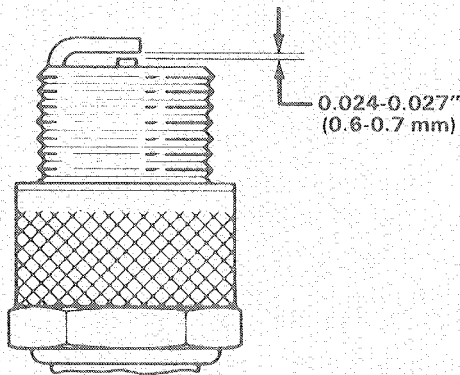

Figure 18

## ADJUSTING THROTTLE-CHOKE CONTROL

Proper choke operation is dependent upon proper adjustment of the throttle control. Before adjusting the carburetor, assure the throttle control is operating properly.

1. Remove the wing bolts holding air cleaner in place and lift air cleaner assembly off carburetor.

2. Move throttle control to CHOKE position and check the position of the choke butterfly; it should be closed fully.

3. Move throttle control to FAST position. The butterfly should be in the fully open position.

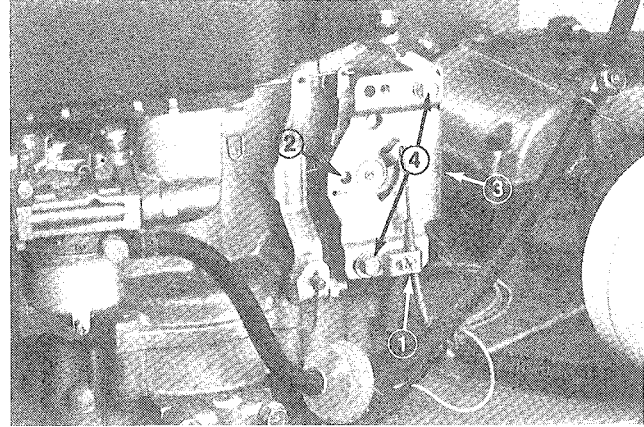

Figure 19

- |                  |                        |
|------------------|------------------------|
| 1. Clamp screw   | 3. Control plate       |
| 2. Aligned holes | 4. Mounting screws (2) |

4. If the choke butterfly is positioned as described in steps 2 and 3, replace the air cleaner assembly and continue operation.

If either the choke butterfly does not close or is not fully open in the FAST position, adjust the throttle control as follows:

1. Place throttle control in FAST position.
2. Loosen the throttle cable clamp screw (Fig. 19) and move the control cable casing and wire until the hole in speed control is aligned with hole in control plate. Tighten cable clamp.
3. Turn in choke adjusting screw (located behind control plate) until light contact is made with flange on control lever.
4. Reassemble air cleaner to carburetor.

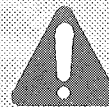

**DANGER**

Engine must be running so final adjustment of the throttle can be performed. To guard against possible personal injury, shift into neutral, and engage parking brake. Keep hands, feet, face, and other parts of the body away from the cutter blades, underside of mower housing, discharge area, and any rotating engine parts.

# MAINTENANCE

5. Start engine and let it warm up for approximately two minutes. Next, make sure throttle control is in FAST position.
6. Loosen (2) control panel mounting screws (Fig. 19).
7. Slide control panel up or down to obtain  $3200 \pm 100$  RPM. Check with tachometer.
8. Tighten control plate mounting screws making sure adjustment is not disturbed.
9. Recheck choke adjusting screw adjustment per instructions in step #3.
10. After throttle is adjusted, stop engine.

## ADJUSTING CARBURETOR

The carburetor has been set at the factory, but an occasional adjustment may be required. An adjustment may be required to compensate for differences in fuel or temperature.

**IMPORTANT:** Before the carburetor is adjusted, throttle control must be checked for proper operation: refer to Adjusting Throttle-Choke Control, page 12.

1. Idle Mixture Screw (Fig. 20) — Close screw by gently rotating it clockwise.

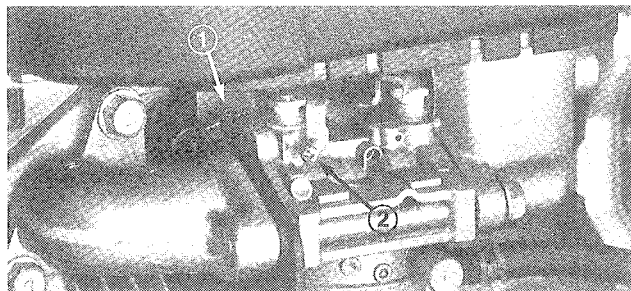

Figure 20

1. Idle mixture screw
2. Throttle stop screw

**IMPORTANT:** Do not close the screw too tight because the valve and seat in carburetor will likely be damaged.

2. Rotate — open — the screw 1–1/8 turns counterclockwise (Fig. 20).

**Note:** The idle mixture screw setting is an approximate; however, the setting will allow engine to be started so carburetor can be fine tuned.

3. Start engine and let it warm up at half throttle for approximately five to ten minutes. Next, move throttle control into SLOW detent.

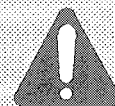

**DANGER**

Engine must be running so final adjustment of the throttle can be performed. To guard against possible personal injury, shift into neutral, and engage parking brake. Keep hands, feet, face, and other parts of the body away from the cutter blades, underside of mower housing, discharge area, and any rotating engine parts.

**IMPORTANT:** Air cleaner must be installed on the engine whenever it is being adjusted. The air cleaner mounting bolts must also be installed when engine is running.

4. Adjust the throttle stop screw to obtain  $1400 \pm 100$  RPM.
5. Adjust the idle mixture screw by turning it clockwise (lean) or counterclockwise (rich) until it idles smoothly.
6. Next, rotate idle mixture screw 1/4 turn counterclockwise.
7. Check and adjust the throttle stop screw to obtain  $1400 \pm 100$  RPM when idling.
8. After carburetor is adjusted, shut engine off.

### Carburetor - High Altitude Correction:

Carburetor jetting should be changed for high altitude operation.

- Standard Main Jet Size is #112.5
- Above 3000 feet, use main jet size #110.
- Above 6000 feet, use main jet size #107.5.

## ADJUSTING AND REPLACING TRACTION BELT

1. Loosen capscrew and flange locknut securing idler pulley to frame (Fig. 21). Slide pulley outward relieving belt tension.
2. Remove left front engine mounting bolt securing clutch retainer to frame (Fig. 21). Unhook retainer from clutch and remove retainer.
3. Disconnect in-line wire connector and remove belt from drive pulley and clutch (Fig. 21).
4. Install new belt around clutch and drive pulley.
5. Secure in-line wire connectors and reinstall clutch retainer to clutch and frame with engine mounting bolt. Torque engine mounting bolt to 170–220 in-lb.

# MAINTENANCE

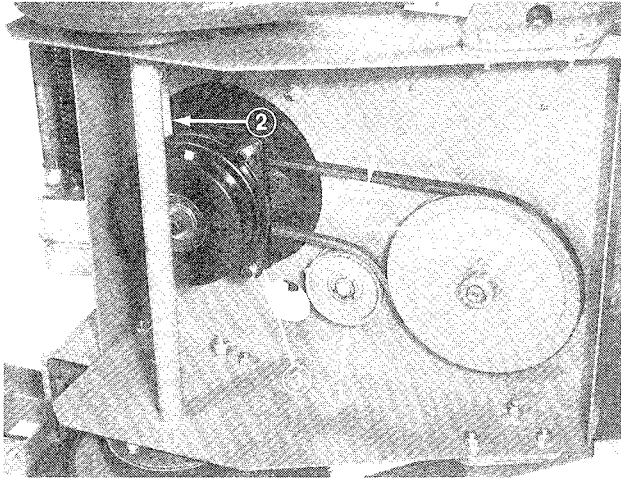

**Figure 21**

1. Idler pulley
2. Clutch retainer
3. Locknut on flange stud

6. Position and secure idler pulley to frame so belt deflection is no more than 11/64" when 5-1/2 lb of force is applied to mid span of long leg of belt (Fig. 21).

## ADJUSTING CLUTCH

The clutch is adjustable to ensure proper engagement and proper braking.

1. To adjust clutch, tighten or loosen locknuts on flange studs (Fig. 21).
2. Check adjustment by inserting feeler gauge thru slots next to flange studs.
3. The proper disengaged clearance between the clutch plates is .012 - .018 inches. It will be necessary to check this clearance at each of the three slots to ensure the plates are parallel to each other.

## BRAKE ADJUSTMENT

An adjustment to the brake may be required to compensate for belt stretching or brake seating.

1. To adjust brakes, refer to Install Control Rod, page 7.

## DRIVE BELT REPLACEMENT

1. Remove top capscrew securing idler support and idler bracket to rear frame (Fig. 22).

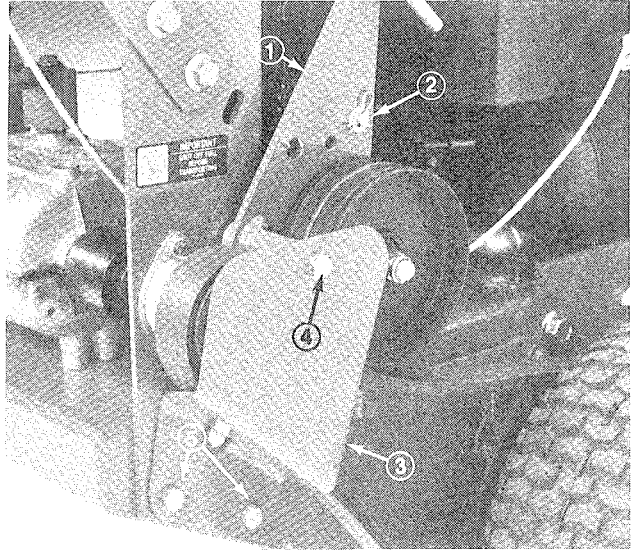

**Figure 22**

1. Idler bracket
2. Hairpin cotter, washer & brake rod fitting
3. Idler support
4. Top capscrew
5. Bottom capscrews

2. Loosen bottom two mounting screws enough to allow belt to pass between drive pulley and idler support (Fig. 22).

3. Raise wheel off ground enough to allow belt removal.

## CLEANING COOLING SYSTEM

Clean engine cooling system frequently, by removing any build-up of grass, dirt or other debris from the cylinder and cylinder head cooling fins, air intake screen on flywheel end, and carburetor-governor levers and linkage. This will help insure adequate cooling and correct engine speed and will reduce the possibility of overheating and mechanical damage to the engine.

# WIRING SCHEMATIC

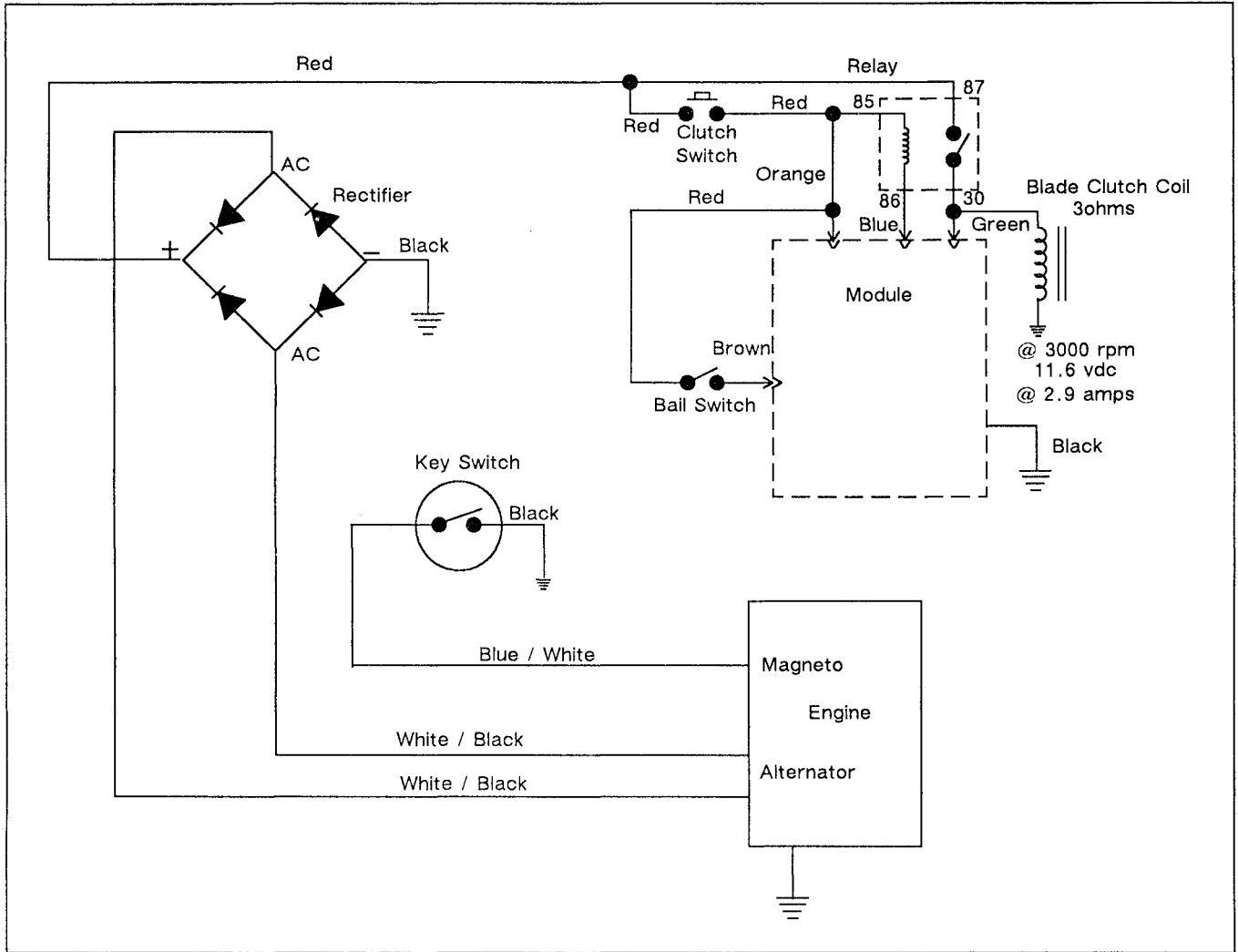

## IDENTIFICATION AND ORDERING

The mower has two identification numbers: a model number and a serial number. The two numbers are stamped into a plate that is riveted to the frame on right front corner of mower. In any correspondence concerning the mower, supply the model and serial numbers to assure that correct information and replacement parts are obtained.

To order replacement parts from an authorized TORO Distributor, supply the following information:

1. Model and serial numbers of the machine.
2. Part number, description and quantity of parts desired.

**Note:** Do not order by reference number if a parts catalog is being used; use the part number.



## THE TORO TOTAL COVERAGE GUARANTEE

A One Year Limited Warranty  
(A Full Two-Year Warranty for Residential Use)

### What Is Covered By This Express Warranty?

The Toro Company promises to repair any TORO ProLine product used for commercial, institutional, or rental purposes if defective in materials or workmanship for a period of one year from the date of purchase. The cost of parts and labor are included as well as transportation within a 15 mile radius of a TORO ProLine Service Dealer.

### What Products Are Covered By This Warranty?

ProLine products covered by this warranty include the ProLine 118 and wide area walk behind mowers and their cutting decks and accessories.

### How About Residential Use?

TORO ProLine products used for residential use are covered by a full two-year warranty.

### How Do You Get Warranty Service?

Should you feel your TORO ProLine product contains a defect in materials or workmanship, contact the dealer who sold you the product or any TORO ProLine Service Dealer. The Yellow Pages of your telephone directory is a good reference source; look under TORO Commercial Service Dealers. The Service Dealer will either arrange service at his/her dealership or recommend another authorized Service Dealer who may be more convenient. You may need proof of purchase (copy of registration card, sales receipt, etc.) for warranty validation.

If for any reason you are dissatisfied with a Service Dealer's analysis of the defect in materials or workmanship or if you need a referral to a TORO ProLine Service Dealer, please feel free to contact us at the following address:

Toro Customer Service Department  
8111 Lyndale Avenue South  
Minneapolis, MN 55420  
612-888-8801

### What Must You Do To Keep The Warranty In Effect?

You must maintain your TORO Product by following the maintenance procedures described in the operator's manual. Such routine maintenance, whether performed by a dealer or by you, is at your expense.

### What Does This Warranty Not Cover? and

### How Does Your State Law Relate To This Warranty?

There is no other express warranty except as described above. This express warranty does not cover:

- Cost of regular maintenance service or parts, such as filters, fuel, lubricants, tune-up parts, blade sharpening, brake and clutch adjustments.
- Any product or part which has been altered or misused or required replacement or repair due to normal wear, accidents, or lack of proper maintenance.
- Repairs necessary due to improper fuel, contaminants in the fuel system, or failure to properly prepare the fuel system prior to any period of non-use over three months.
- Pickup and delivery charges for distances beyond a 15 mile radius from a TORO ProLine Service Dealer.

All repairs covered by this warranty must be performed by a TORO Service Dealer using Toro approved replacement parts.

Repair by a TORO Service Dealer is your sole remedy under this warranty.

**The Toro Company is not liable for indirect, incidental or consequential damages in connection with the use of the TORO Products covered by this warranty, including any cost or expense of providing substitute equipment or service during reasonable periods of malfunction or non-use pending completion of repairs under this warranty. Some states do not allow exclusions of incidental or consequential damages, so the above exclusion may not apply to you.**

**This warranty gives you specific legal rights, and you may also have other rights which vary from state to state.**

### COUNTRIES OTHER THAN THE UNITED STATES OR CANADA

Customers who have purchased TORO products exported from the United States or Canada should contact their TORO Distributor (Dealer) to obtain guarantee policies for your country, province, or state. If for any reason you are dissatisfied with your Distributor's service or have difficulty obtaining guarantee information, contact the TORO importer. If all other remedies fail, you may contact us at The Toro Company.