

200-Series Lawn Tractors

MODELS

32-10B503-2000001 & UP
32-12O503-2000001 & UP



Wheel Horse
Operator's Manual

Specifications
Operating Instructions
Maintenance Information

FOR YOUR SAFETY

Two of the most potentially serious types of accidents involving power mowers are contact with the mower blade and overturning the rider/tractor. To minimize the possibility of having these types of accidents, read

and follow these instructions. Also refer to the Safe Operation Practice in this Operator's Manual for other important safety information.

FOR BEST PERFORMANCE:

- FOLLOW OPERATOR'S MANUAL INSTRUCTIONS
- OPERATE ENGINE AT FULL THROTTLE
- CHECK AND ADJUST MOWER LEVEL PERIODICALLY
- CLEAN UNDERSIDE OF MOWER FREQUENTLY
- KEEP MOWER BLADES SHARP AND BALANCED
- KEEP P.T.O. AND BELTS ADJUSTED

BEFORE EACH USE:

- CHECK SAFETY INTERLOCK SYSTEM
- CHECK ENGINE OIL LEVEL
- CHECK BATTERY WATER LEVEL
- CHECK TRANSMISSION OIL LEVEL (AUTOMATIC)
- CHECK GENERAL EQUIPMENT CONDITION
- CLEAN ENGINE CHAFF SCREEN

EVERY 25 HOURS:

- CHECK TIRE PRESSURE: INFLATE TO 12 P.S.I.
- CHECK FASTENERS: IN PLACE AND TIGHT
- SEE OPERATOR'S MANUAL FOR OIL CHANGE, OIL FILTER & AIR FILTER SERVICE INTERVAL
- CHECK TRANSMISSION OIL LEVEL (8 SPEED)
- LUBRICATE CHASSIS AND FRONT WHEELS

LOCATED ON REAR OF HOOD - DECAL PART NUMBER 116590

RIDER/TRACTOR STABILITY

ALWAYS:

Vehicle stability changes with conditions and is affected by:

- Slope angle and length/bumps/holes, etc.
- Slippery conditions (lawn moisture and length)
- Operator size and position/how loaded/equipment used
- Speed/braking/steering changes
- Operator physical limitations/alertness

- Use good judgement when operating the rider/tractor, especially on slopes.
- Maintain the vehicle in good operating condition.
- Be attentive to changing conditions affecting vehicle stability.

NEVER:

- Operate vehicle on extreme slopes.
- Operate vehicle across slopes.
- Abruptly change speed or direction.



DANGER

TO AVOID INJURY

NEVER MOW
SIDE HILL
OVER 5°



NEVER MOW
UP HILL
OVER 10°



NEVER MOW
SLOPE
OVER 15°



- STOP BLADE & BACK SLOWLY IF MACHINE STOPS GOING UPHILL
- NEVER MOW NEAR PEOPLE
- NEVER USE WHEN UNDER INFLUENCE OF DRUGS OR ALCOHOL
- NEVER CARRY PASSENGERS
- SET PARKING BRAKE & REMOVE KEY IF LEAVING MACHINE
- AVOID SLIPPERY OR STEEP AREAS
- AVOID BLADE UNLESS BLADE & ENGINE ARE STOPPED
- USE SAFELY; MACHINE IS NOT A TOY
- KNOW LOCATION AND FUNCTION OF CONTROLS
- REMOVE POTENTIAL THROWN OBJECTS
- KEEP SAFETY DEVICES IN PLACE AND WORKING
- LOOK BEHIND MACHINE BEFORE BACKING

READ OWNER'S MANUAL

LOCATED ON HOODSTAND UNDER STEERING WHEEL - DANGER DECAL PART NUMBER 112670

BLADE CONTACT

! DANGER! Mower Blades are Designed to CUT: therefore,

ALWAYS:

- Shut off engine and set parking brake.
- Remove ignition key.
- Allow moving parts to stop before dismounting, servicing, or cleaning unit.

NEVER:

- Perform ANY work on the mower with engine running.
- Mow with other people around, especially children.
- Leave mower unattended.



LOCATED ON MOWER DEFLECTOR AND CUTTER DECK
DECAL PART NUMBER 54-9220

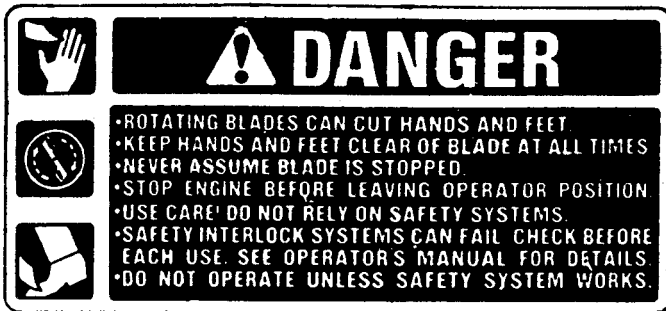

LOCATED ON FRAME PLATE UNDER STEERING WHEEL
DECAL PART NUMBER 79-0370



LOCATED ON MOWER DEFLECTOR AND CUTTER DECK
DECAL PART NUMBER 66-1340

DECALS WITH LOCATIONS

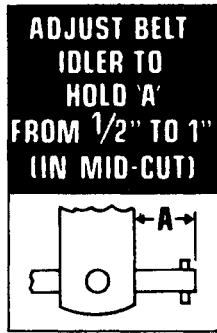

ON MAIN FRAME UNDER ENGINE
PART NUMBER 113370

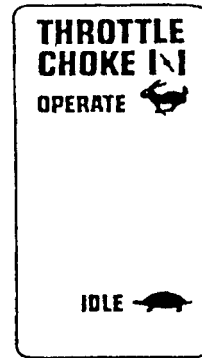

NEXT TO THROTTLE CONTROL
PART NUMBER 111706

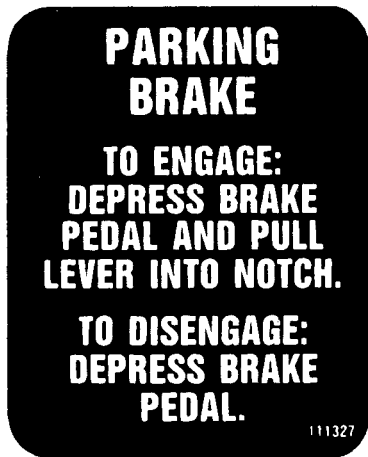

RIGHT SIDE OF FRAME
NEXT TO BRAKE CONTROL
PART NUMBER 111327

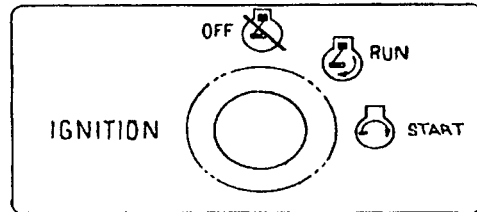

ON PANEL UNDER STEERING WHEEL
PART NUMBER 79-5400



ON PANEL UNDER STEERING WHEEL
NEXT TO PTO SWITCH
PART NUMBER 78-8440

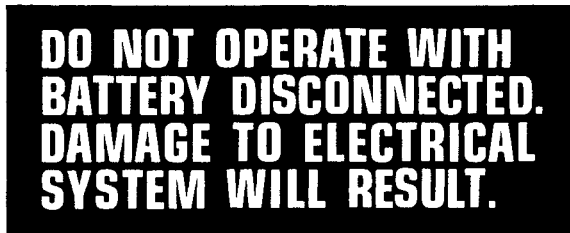

ON HOODSTAND NEXT TO BATTERY
PART NUMBER 111926

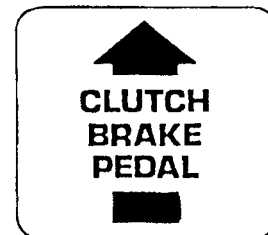

ON FRONT OF RIGHT FOOT REST
PART NUMBER 111632



ON 30" MOWER UNDER DISCHARGE CHUTE
PART NUMBER 66-6380



UNDER STEERING WHEEL
NEXT TO GEAR SHIFT LEVER
PART NUMBER 114944

CONTENTS

	Page		Page
General Safety Suggestions	i-iii	Maintaining Your Tractor	8-15
Machine Specifications	1	Maintenance Checklist	8
Model and Serial Numbers	2	Engine	8-10
Registration and Warranty	2	Oil Quality	8
Instruments and Controls	3-4	Oil Level	8
Operating Your Tractor	5-6	Oil Filter	9
Safety Interlock System	5	Oil Changes	9
Seat Control	5	Air Filter	9-10
Correct Engine Operation	5	Spark Plug	10
Starting Engine	5	Carburetor Adjustment	10
Stopping Engine	5	Fuel Filter	10
Throttle and Choke Control	5	Charging and Electrical Systems	11
Fuel Specification	6	Alternator	11
Oil Specification	6	Main Fuse	11
Correct Mechanical Transmission		Light Circuit	12
Operation	6	Battery	12
To Go Forward	6	Light Bulb Replacement	12
To Change Speed or Direction	6	Mechanical Transmission	12
To Stop	6	Chassis Lubrication	12
Parking Brake	6	Steering Gear Tooth Adjustment	12
Correct Tractor Usage	7	Gear Shift Lever Adjustment	13
Operation of Tractor	7	Clutch Adjustment	13
With Mower	7	Brake Adjustment	13
With a Snowthrower	7	Drive Belt Tension Adjustment	14
With a Snow Blade	7	PTO Clutch/Brake Adjustment	14
With Other Attachments	7	Cleaning and Storage	14-15
		Trouble Shooting Checklist	16-17
		Wiring Diagram	18-19

These symbols mark important instructions relating to your personal safety. To avoid possibility of injury, read and follow such instructions carefully.

⚠ DANGER ⚠ *This symbol warns of extreme immediate hazards which will result in severe personal injury or death if proper precautions are not taken.*

⚠ CAUTION ⚠ *This symbol warns of a hazard or unsafe practice which can result in personal injury or death if proper precautions are not taken.*

When manual refers to left or right side of vehicle, it means your left or right when sitting in driver's seat.

SAFE OPERATION PRACTICES – RIDING VEHICLES

GENERAL

1. This machine is capable of amputating hands and feet and can throw objects that can cause injury and damage. KNOW the controls and how to stop machine quickly. READ THIS OPERATOR'S MANUAL and instructions furnished with attachments. Read, understand, and obey all safety messages appearing on the machine and in the operator's manual. LEARN from your operator's manual and from careful EXPERIENCE how to operate your equipment correctly. Know your machine's limitations.
2. Keep hands, feet, hair and loose clothing away from attachment discharge area, underside of mower deck or any moving parts while engine is running.
3. The use of drugs or alcohol while operating any equipment will place your safety in peril. Do not attempt operation of this machine while taking drugs or medication or while drinking alcoholic beverages.
4. Only responsible persons with mature judgment and proper physical capabilities should be allowed to operate this machine, and only after instruction in the proper use of this equipment.
5. Do not allow children to operate machine.
6. Do not carry passengers.
7. The purpose of this machine is to perform work. This equipment is not intended for sport or recreation.
8. Do not mow when people or pets are around.

9. Clear work area of objects (wire, rocks, etc.) which might be picked up and thrown.
10. Take all possible precautions when leaving vehicle unattended, such as disengaging power-take-off, lowering attachments, shifting into neutral, setting parking brake, stopping engine and removing key.
11. Watch out for traffic when crossing or near roadways.
12. Machine and attachments should be stopped and inspected for damage after striking a foreign object. Damage should be repaired before restarting and operating equipment.
13. Do not change engine governor settings or over-speed engine.
14. Wear appropriate protective clothing when operating equipment. Long pants and substantial footwear, not barefoot or open sandals, are essential.
15. Do not operate equipment unless properly seated with feet on footrests or pedals.
16. Keep your eyes and mind on your machine, attachment and the working area. Do not let other interests distract you.
17. Safety switch(es) are intended to stop or prevent starting of engine to help prevent accidents. **OPERATOR SHOULD TAKE PRECAUTIONS AND NOT RELY ENTIRELY ON SAFETY SWITCH(ES).**
18. Care should be used not to touch equipment or attachment parts which may be hot from operation. Muffler and nearby areas may exceed 150° F. Allow cooling to occur before attempting to maintain, adjust or service.
19. Use of stereo headphones, ear protection or other sound altering/dampening devices may limit your ability to hear warning sounds (horns, shouts, etc.).

FUEL/FIRE PRECAUTIONS

20. Handle gasoline with care — it is highly flammable.
21. Use approved gasoline container. Place container out of reach of children.
22. Use gasoline only as a fuel — never as a cleaner.
23. Never remove fuel cap or add gasoline to a running or hot engine, or an engine that has not been allowed to cool for several minutes after running.
24. Never fill fuel tank indoors. Wipe up spilled gasoline.
25. Open doors if engine is run in garage — exhaust fumes are dangerous. Do not run engine indoors.
26. Do not fill machine with gasoline while smoking or when near open flame or sparks.
27. Never store equipment with gasoline in the tank inside a building where fumes may reach an open flame or spark.
28. Allow engine to cool before storing in any enclosure.
29. To reduce fire hazard, keep engine and attachments free of grass, leaves or excessive grease.
30. Battery acid is a poison and can cause burns. Avoid contact with skin, eyes and clothes and

protect your face, eyes and clothing when working around the battery.

31. Battery gases can explode. Keep cigarettes, sparks and flames away from battery.

EQUIPMENT USE AND OPERATION

32. It is recommended that first operation of equipment be done at a slow speed with attachment disengaged. Continue this practice until operator is thoroughly familiar with the controls and has developed operating skills.
33. Disengage all attachment clutches, set parking brake and shift into neutral before attempting to start engine.
34. Disengage power to attachment(s), set parking brake and stop engine before leaving operator position.
35. Disengage power to attachment(s) and stop engine before making any repairs or adjustments.
36. Disengage power to attachment(s) when transporting or not in use.
37. Disengage attachment clutch before attempting to remove the mower from a hole or other obstruction.
38. Disengage power to attachment(s) before backing. Do not mow in reverse unless absolutely necessary and then only after careful observation of the entire area behind the machine.
39. LOOK behind machine to make sure the area is clear before placing the transmission in reverse and continue looking behind while backing.
40. Always back up loading ramps and tilt bed trailers.
41. The parking brake is designed to hold tractor in place at rest, with engine off. Parking brake **will not** restrain tractor with engine running and transmission engaged.

STABILITY/TIPOVER/TRACTION

42. Know the terrain on which you are operating your equipment. There are areas on which your equipment can not be safely operated.
43. Avoid operating equipment on hillsides, slopes or rough terrain. **DO NOT** operate machine on hillsides or slopes exceeding 15° (27% grade). If safety is in doubt — **STAY OFF THE SLOPE.**
44. Reduce speed and exercise extreme caution on slopes above 10° (18% grade) to prevent tipping or loss of control. Never mow uphill on these slopes — mow downhill only. If a steep hill must be ascended, back up the hill, and drive forward down the hill, keeping tractor in gear. If necessary to turn on hill, always turn downhill.
45. Mow up and down the face of slopes greater than 5° (9% grade), never across the face. Be especially cautious when changing directions on all slopes.
46. Operate your machine smoothly and at a ground speed slow enough to insure complete control at all times. Avoid erratic operation and excessive speed.
47. Sharp turns on any terrain may cause loss of control. Reduce speed and use caution when making sharp turns.

48. Do not stop or start suddenly when going uphill or downhill. Avoid uphill starts. If machine is stopped going up a slope, turn the attachment off and back slowly down the slope keeping the machine in gear. Do not stop or change gears (speed) on slopes.
49. Know the terrain on which you are working. Find hidden obstacles by walking through and inspecting the area prior to operating your equipment in that area. Plainly mark obstacles, such as rocks, ruts or holes and **stay well clear of these obstacles** when operating.
50. While operating, stay alert for holes, rocks or roots, which may cause damage to equipment or upset. Keep at least 3 ft. away from drop-offs, ditches, creeks, culverts, washouts and public highways.
51. Exercise care when mowing around a fixed object to prevent the equipment or attachment from striking the object. When mowing never deliberately run over any foreign object.
52. Areas wet with dew, rain or snow will be more slippery than when dry. Areas covered with loose gravel are more slippery than firm dry ground. Greater stopping distances are required in these slippery areas.
53. Learn to expect changes in operating conditions. Adding or removing attachments or weight to your equipment will make your machine perform differently. Rain, snow, loose gravel, wet grass, etc., change the tractive conditions of the terrain requiring changes in your operating technique, which may include a decision not to operate on that terrain.
54. Use care when pulling loads or using heavy equipment.
 - A. Use only approved drawbar hitch points.
 - B. Limit loads to those you can safely control.
 - C. Do not turn sharply. Use care when backing.
 - D. Use counterweight(s) or wheel weights when suggested in operator's manual.
60. When using machine with snowthrower and auger becomes plugged or jammed:
 - A. Declutch snowthrower and stop tractor engine immediately.
 - B. Disconnect spark plug wire(s).
 - C. Clear snow from discharge chute if plugged.
 - D. If auger is jammed, remove foreign object and repair any damage to snowthrower before continuing.
 - E. Reconnect spark plug wire(s) and resume operation.
61. Never permit anyone to stand near snowthrower auger or discharge opening. Objects may be present in snow, which when thrown, could cause injury.
62. When using snow/dozer blades:
 - A. Avoid hitting solid objects. This can damage blade and injure operator.
 - B. Always travel at a safe, slow speed.
63. Keep all persons a safe distance away when operating tillers. Always disengage the PTO, lower the attachment and remove the ignition key before making any adjustments.
64. If tiller starts to push tractor, disengage PTO clutch immediately.
65. Use chains, counterweight(s) or wheel weights when suggested in the operator's manual.

MAINTENANCE

ATTACHMENT USE

55. When using attachments never direct discharge of material toward bystanders nor allow anyone near vehicle while in operation.
56. When using machine with mower:
 - A. Mow only in daylight or in good artificial light.
 - B. Never make a cutting height adjustment while engine is running if operator must dismount to do so.
 - C. Shut engine off when unclogging chute.
 - D. Check blade mounting bolts for proper tightness at frequent intervals.
57. Keep hands and feet away from rotating blade(s) underneath mower deck. Never place foot on ground when mower is engaged or when mower is in motion.
58. **DO NOT** operate mower attachment without the chute deflector or complete bagger in place.
59. Exercise care while maneuvering with grass catcher. Front to rear stability may change.
66. Keep all nuts, bolts, fasteners and screws tight to be sure equipment is in safe working condition and check them frequently. Repair or replace worn, damaged, distorted or broken parts as needed.
67. Keep vehicle and attachments in good operating condition and keep safety devices in place and working.
68. Under normal usage, grass catcher bag material is subject to deterioration and wear. It should be checked frequently to determine need for bag replacement.
69. Use only genuine Wheel Horse replacement parts to assure that original standards are maintained.
70. Shields, deflectors, switches, blade controls and other safety devices must be in their proper position and functional.
71. Do not operate without muffler or tamper with the exhaust system. Damaged mufflers or spark arresters can create a fire hazard. Periodically inspect and replace if necessary.
72. If equipment begins to vibrate abnormally, disengage power to attachments and stop engine at once. Repair any damage before starting or continuing operation.
73. Periodically inspect all shafts, levers, friction devices and other moving parts subject to wear. Make required adjustment or replace these parts if damaged, distorted or broken, or as soon as wear affects the normal operation of the vehicle or attachment. **DO NOT** operate equipment that is not functioning properly.

SPECIFICATIONS:

ENGINE:

MACHINE MODEL	ENGINE MODEL*	RATED H.P.**	DISPLACEMENT cu. in./cc	BORE in./mm	STROKE in./mm	IGNITION
210-5	B-257707-0123-01	10.5	4.36/400	3.44/87.3	2.62/66.7	Electronic
212-5	E125V-N/10964B	12.5	23.7/389	3.31/84.1	2.76/70.0	Electronic

*Letter Prefix: B=Briggs & Stratton, E=TORO POWER PLUS. Basic engine model number shown; type and serial numbers from engine I.D. plate are required to completely identify engine. **Engine manufacturer's rating at 3600 RPM

TRANSMISSION:

Type: Mechanical All Gear

5-Speed

1st	1.1 mph (1.8 kph)	4th	3.3 mph (5.2 kph)
2nd	1.4 mph (2.3 kph)	5th	5.0 mph (8.1 kph)
3rd	2.2 mph (3.5 kph)	Rev.	2.4 mph (3.8 kph)

ELECTRICAL SYSTEM:

210 MODEL

212 MODEL

Type:	12 Volt D.C., Negative Ground	12 Volt D.C. Negative Ground
Alternator:	12 Volt, 5 amp. Unregulated	12 Volt, 13 amp. Regulated
Battery:	12 Volt, 160 CCA	12 Volt. 160CCA

TIRES:

	SIZES - FRONT	SIZES - REAR	PRESSURE - FRONT	PRESSURE - REAR
210-5	15 x 6.00-6	18 x 9.50-8	12 psi (.85 kg/cm ²)	12 psi (.85 kg/cm ²)
212-5	15 x 6.00-6	18 x 9.50-8	12 psi (.85 kg/cm ²)	12 psi (.85 kg/cm ²)

PHYSICAL DATA:

MODEL	HEIGHT	LENGTH	OVERALL WIDTH	WHEEL BASE	INSIDE TURNING RADIUS	NET WEIGHT (Approximate)
210-5, 212-5	36.0 in. (91.4 cm)	63 in. (160 cm)	31 in. (78.7cm)	44.5 in. (113.0 cm)	25 in. (63.5 cm)	330 lbs. (134 kg)

TUNE-UP/GENERAL MAINTENANCE SPECIFICATIONS:

ENGINE:

MACHINE MODEL	POINT GAP in./mm	TIMING MARK LOCATION	IGNITION TIMING (BTDC)	SPARK PLUG TYPE	SPARK PLUG GAP in./mm	DIRECTION OF ROTATION (Facing Drive Pulley)	IDLE RPM (No Load)	GOVERNED MAX. RPM (No Load)
210-5	N/A	N/A	Fixed	RJ-19LM*	.030/.76	Counterclockwise	1750	3400
212-5	N/A	N/A	Fixed	BPR4HS-10**	.035/.88	Counterclockwise	1400	3350

* Or equivalent (Champion number shown)

** Or equivalent (NGK number shown)

LUBRICANT/FUEL CAPACITIES:

CRANKCASE:
Briggs & Stratton 1-1/2 qts. (1.4 l)
TORO POWER PLUS 1 1/2 qts. (1.4l) w/o Filter
 1.65 qts. (1.55l) w/ Filter

FUEL TANK:
 1-1/2 Gallons (5.7 l)

CHASSIS:
 Grease Fittings : 6

MODEL AND SERIAL NUMBER LOCATIONS

Model and Serial numbers are used to identify your new tractor and major attachments. These numbers should always be referred to when consulting dealer or factory concerning service, parts, or other information you may require. If these plates are removed during repair operations, they should always be replaced.

Tractor model and serial number plate is located just below seat on rear fender.

Engine identification numbers are located on engine shrouding and indicate model, specification or type number and serial number of tractor's engine.

Major attachments also have a model and serial number plate attached to them.

For your convenience and ready reference, enter tractor and engine numbers below.

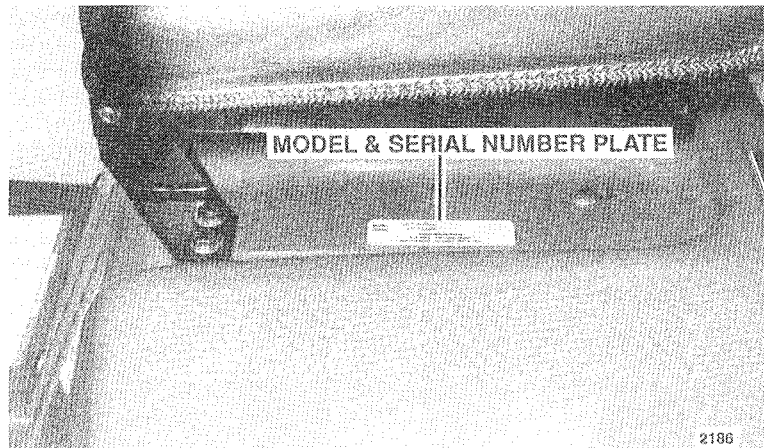

Model and Serial Number Plate Location

Tractor Model and Serial Number

MODEL	
SERIAL	
TORO Wheel Horse 515 WEST IRELAND ROAD SOUTH BEND, INDIANA 46614 USA	

Engine Identification Number

Model _____

Type or Spec. No. _____

Serial Number _____

OWNER REGISTRATION AND WARRANTY

Service and warranty assurance is as important to Toro Wheel Horse as it is to you, the owner. To facilitate warranty service at an Authorized Toro Wheel Horse Dealer, Toro Wheel Horse requires factory registration. A registration card is supplied with each new tractor and attachment. **Either you or your dealer must fill in required information and mail card to Toro Wheel Horse.**

Toro Wheel Horse Limited Warranty Statement is on a "hang tag" attached to each product. This statement describes what items are covered by the Toro Wheel Horse Limited Warranty, your rights and obligations, and procedure to follow to obtain warranty service. Please familiarize yourself with the warranty statement. **All of us at Toro Wheel Horse want you to be satisfied with your Toro Wheel Horse tractor; please don't hesitate to contact us for assistance.**

INSTRUMENTS AND CONTROLS

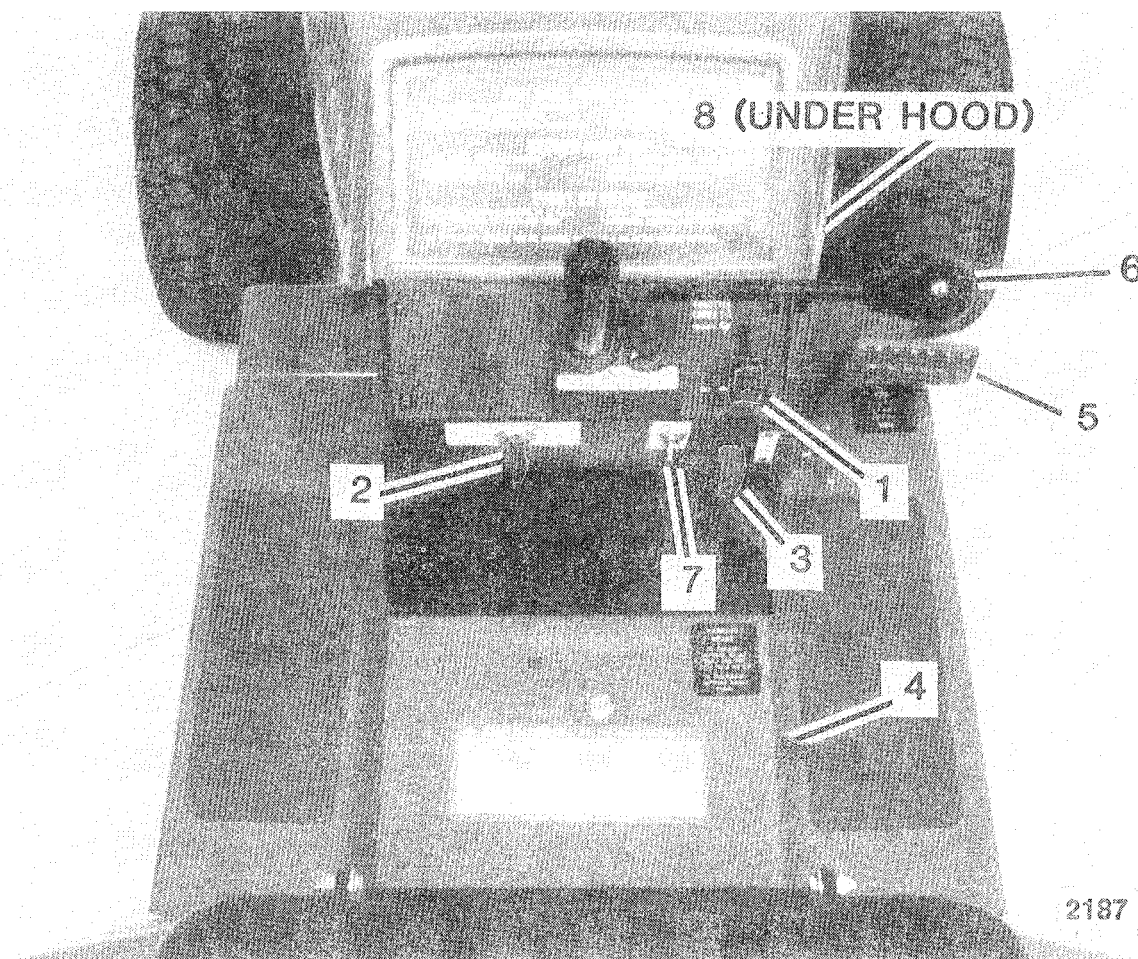

1. COMBINED THROTTLE/CHOKE CONTROL

Combined throttle/choke control is located on upper right side of dash panel. To start engine raise lever all the way up past detent to Choke position. To operate tractor raise lever to detent position near top of slot. Lower lever before shutting engine off. If engine is warm or has been running, raising lever to Choke position may not be necessary to restart it.

2. IGNITION SWITCH

Ignition switch is located on center left side of dash panel near steering column. Ignition switch has three positions from left to right: (1) Off, (2) Run, (3) Start. To start engine turn key all the way right, to Start position. Release key when engine starts and it will automatically return to Run position. When switch is turned to Off position, engine stops and all electrical accessories are turned off.

3. PTO (POWER TAKE-OFF) CLUTCH SWITCH

PTO switch is located on right side of dash panel

below throttle control. Push down on top of switch cover and pull up on bottom to engage PTO. Push down on switch cover to disengage PTO. PTO clutch switch actuates a safety interlock switch in starter circuit; therefore tractor will not start unless lever is in disengaged position. If operator's seat is vacated while PTO is engaged, engine will automatically shut off.

4. PARKING BRAKE LOCK LEVER

Parking brake lever is located in front of seat on right side of frame. To engage parking brake, first apply foot brake/clutch pedal solidly and then move parking brake lock lever up and back to lock brake. To release parking brake push down on brake/clutch pedal. Parking brake lock lever is spring loaded and will return to disengaged position when foot brake/clutch pedal is applied.

5. BRAKE/CLUTCH PEDAL

Brake/clutch pedal is located at front of tractor just right of steering console. Pushing down on pedal

declutches drive belt, disconnects engine from transmission, and applies brake. Always release pedal slowly when engaging clutch. Always depress pedal when shifting transmission into or out of gear and when starting engine.

6. GEAR SHIFT LEVER

Gear shift lever is located to right side of steering wheel. Select any forward speed by moving lever right or left as indicated on shift pattern decal. Push lever down and pull back for reverse. Gear shift lever actuates a safety switch in starter circuit; therefore tractor will not start until transmission is in neutral.

7. LIGHT SWITCH (Not on all units)

Light switch is located on right center side of dash panel near steering column. Raise toggle switch to turn lights on. Lower toggle switch to turn lights off.

8. FUEL SHUT-OFF VALVE

Fuel shut-off valve is located at bottom of fuel tank. Fuel shut-off valve is normally left open, except when service on fuel system becomes necessary.

OPERATING YOUR TRACTOR

SAFETY INTERLOCK SYSTEM

Safety interlock system incorporates two switches, for safe starting.

Starting switches are actuated by gear shift lever and PTO control. If tractor will not start, check that PTO control is disengaged and gear shift is in neutral. Engine will not start unless both switches are properly actuated.

Seat interlock system must be tested before each use. To test operation, following functions must be observed. If not, immediate repairs must be performed by an Authorized Wheel Horse Dealer for your protection.

1. Engine should NOT start if:
 - a. Gear shift is in gear.
 - b. PTO is engaged.Test each of the above, one at a time.
2. With engine running and PTO engaged, test operate seat switch by raising off seat. Engine should shut off.

SEAT CONTROL

Model 212 Only

For adjustment, loosen bolts under seat, slide seat to desired position and retighten bolts.

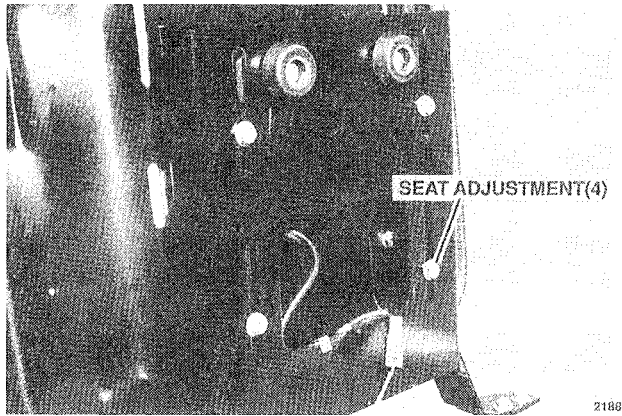

Model 212 Only Seat Adjustment

Model 210 Only

For adjustment, loosen knobs under rear fender, move seat to desired position and retighten knobs.

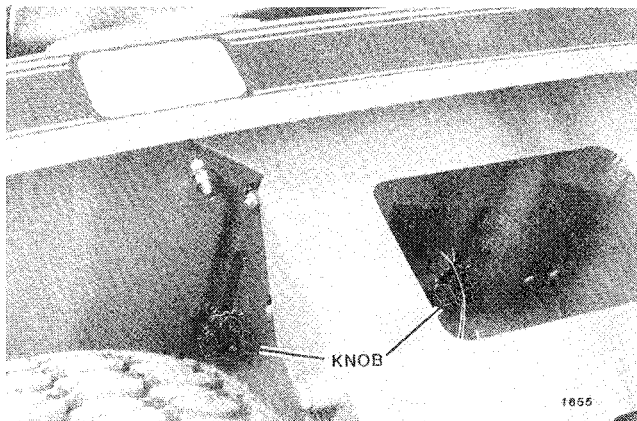

Model 210 Seat Adjustment

CORRECT ENGINE OPERATION

⚠ CAUTION ⚠

Before starting engine, become familiar with all controls. Read this Operator's Manual thoroughly. Always check engine oil level before starting. Always check transmission oil level before starting.

⚠ DANGER ⚠

Care should be taken to avoid inhaling exhaust gases as they contain carbon monoxide gas which is colorless and odorless. Carbon monoxide is a dangerous gas that can cause unconsciousness and is potentially lethal.

Do not run engine in confined areas such as a closed garage.

Starting Engine

Because of a built-in safety interlock system, your tractor will not start until gear shift is in neutral and PTO is disengaged.

To start engine move gear shift to neutral and disengage PTO.

Move throttle/choke control lever to Choke position.

Turn ignition key clockwise until starter engages. When engine starts, release key. Switch is spring loaded and will return to Run position automatically.

If engine fails to start after 30 seconds of continuous cranking, turn key to Off position and allow starter motor to cool. Check for cause of hard starting; consult Troubleshooting Checklist.

Once engine has started, slowly return throttle/choke control to Operate position. If engine stalls or hesitates during operation, choke should be applied as necessary until engine reaches normal operating temperature.

Stopping Engine

To stop engine, return throttle lever to idle position and turn ignition key to Off position. If engine has been working hard, or is hot, allow engine to idle a short time before turning key off. This practice will help to cool engine before stopping.

Note: In case of emergency, engine may be stopped by turning ignition key to Off position.

⚠ CAUTION ⚠

Always remove key and set parking brake when leaving tractor unattended, even if for just a few minutes. Prevent accidents, do not give children or unauthorized persons an opportunity to operate this machine.

Throttle and Choke Control

Throttle control regulates speed of engine as measured in RPM (Revolutions Per Minute). This control should not be used to regulate ground speed of tractor.

The engine in your new Wheel Horse has been designed with a special governor that limits maximum RPM. The governor allows engine to operate most efficiently at a set speed, and protects it from damage caused by excessive RPM. Always operate tractor with throttle control set at full speed.

Engine MUST be operating at full throttle whenever tractor is in use. Using tractor while engine is operating at less than full throttle may result in poor overall tractor performance and battery may discharge.

Choke control activates a "butterfly" valve in carburetor. When choke is partially or completely closed, less air is admitted to engine. This results in a higher fuel-to-air (richer) mixture that is easier to ignite when engine is started cold. Warm engines may not need choking.

Fuel Specification

⚠ CAUTION ⚠
Handle fuel with care - It is highly flammable. Use only approved fuel container. Never add fuel while engine is running. Fill fuel tank outdoors with extreme care. Never fill fuel tank indoors. Replace gasoline cap securely and wipe up all spilled fuel.

When tractor requires refueling, fill tank with a good grade (85 octane minimum) of regular gasoline. Leaded or unleaded regular may be used. Do not intermix regular and unleaded gasolines. Do not mix oil with gasoline. Use of gasohol is not recommended by engine manufacturer.

In general, use of unleaded fuel will reduce buildup of combustion deposits in engine and contributes to long valve life.

Oil Specification

To protect your tractor's engine, check oil level before each use.

Complete information concerning recommended oils and how to check oil level is given in "Maintaining Your Tractor" section of this manual.

CORRECT TRANSMISSION OPERATION

To Go Forward or Reverse

Tractor is equipped with a reverse "lock out" that helps prevent shifting into reverse accidentally. To shift tractor into reverse, push lever down and pull back into reverse position.

With engine running, depress clutch/brake pedal. Move gear shift lever to desired speed forward or to reverse. Shift plate decal identifies various speeds. Slowly release pedal. As pedal is released, tractor will begin to move.

⚠ CAUTION ⚠
Always release brake/clutch pedal slowly when starting tractor in motion. Sudden starts can be damaging to equipment and could cause loss of operator control.

To Change Speed or Direction

When a change in ground speed or direction is required, always bring tractor to a complete halt by depressing clutch/brake pedal.

⚠ CAUTION ⚠
Never attempt to shift gears with tractor in motion. Severe internal transmission damage may result.

Change gears as desired. Approximate ground speed for each gear is shown in specifications in front of this manual. It is not necessary or recommended to shift "up" or "down" through gears with tractor in motion. Tractor has sufficient power to move out in any gear. If tractor will not move out in a selected gear with a heavy load attached, a lower gear should be used.

To Stop

To stop tractor, depress clutch/brake pedal. Always engage parking brake before leaving tractor.

Parking Brake

Parking brake should be set every time tractor is vacated. To set parking brake, depress foot pedal and lift up on parking brake release lever. Hold release lever up and release foot pedal to set parking brake. To release parking brake, push on foot pedal and then release.

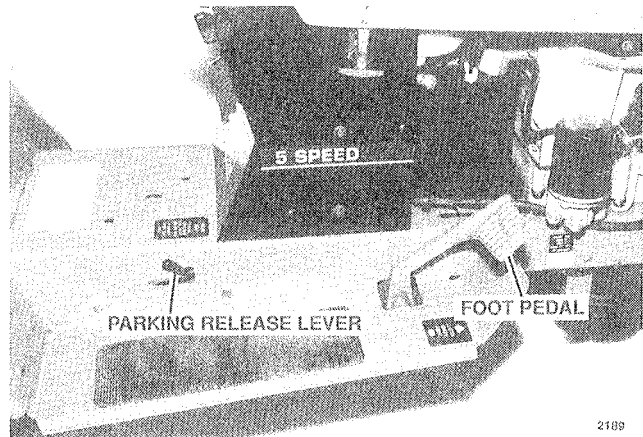

Parking Brake

CORRECT TRACTOR USAGE

OPERATION OF THE TRACTOR

When using attachments under normal conditions your tractor should have sufficient power. On rough, hilly, or wet terrain, addition of wheel weights and tire chains will minimize rear tire slippage. All front tires may be fluid filled.

With Mower

⚠ DANGER ⚠
Keep all shields and mower discharge chute in place. Never put hands or feet under mower deck. Never attempt to clear discharge areas or mower blades without disengaging PTO clutch and removing ignition key.

For best operation on average lawns, operate engine at full throttle while controlling ground speed with transmission. Operate the tractor so that its speed across the mowing situation is between 2 and 3.5 MPH (3.2 to 5.6 KPH)* while mowing grass. Uneven cutting is often a result of excessive ground speed. To correct, reduce ground speed with transmission. Average lawns are usually cut at a height between 2 and 3 in. (5-7.6 cm). Tall grass and weeds should be cut with mower in its highest position, making a second pass cutting at height desired.

⚠ CAUTION ⚠
Sharp edges of mower blades can cut you during blade maintenance or adjustment. Use suitable covering over cutting edges of blade to prevent bodily harm.

With Snowthrower

⚠ CAUTION ⚠
Thoroughly inspect area where snowthrower use is intended. Remove all door mats, sleds, boards and other foreign objects. Never make any adjustments while engine is running. Never try to clear chute while engine is running.

Snow removal will vary greatly with conditions of each snowfall. Clearing light fluffy snow will be an easy task. Heavy wet snow removal will be more difficult. It is advisable to coat auger and chute with a light coat of wax or paraffin to keep snow from sticking. Best results are usually attained when tractor ground speed is set at 1 to 2 MPH (1.6 to 3.2 KPH).*

Experience will teach you not to throw snow into wind.

Use care whenever snowthrower is engaged.

Auger is capable of picking up sticks, stones and other foreign objects and expelling them with great velocity. Always aim discharge chute away from persons or objects subject to harm.

Tire chains and wheel weights are recommended when using a snowthrower.

With Snow Blade

Front end snow blade is used for snow removal. Care should be taken and a slow ground speed should be maintained whenever blade is used.

Impact with a solid object may result in injury to operator and/or damage to blade.

Tire chains and wheel weights may be added to improve traction.

Other Attachments

There are many other special-purpose attachments available, which greatly increase tractor's versatility. Attachment can be one intended for operator comfort (snow cab). Attachments are custom designed for a particular tractor model, but many others simply use tractor as a towing vehicle. They attach or remove from tractor by installation or removal of a single drawbar hitch pin. Some of these attachments are ground driven and some are simply towed such as dump cart.

In any case, all these attachments should be approached with the same amount of caution given any mechanical device. Always read each Operating Instruction Manual carefully before attempting to use attachment. Keep children and pets away from vehicle when in operation. Never allow any unauthorized personnel to operate equipment.

Your authorized Toro Wheel Horse dealer can help you with selecting attachments for use with your tractor.

DUMP CART LOAD LIMIT
Toro Wheel Horse recommends following load limit be observed when using tractor with a dump cart on slopes. Load limit has been set to provide for safe braking on slopes.
150 lbs. (69 kg)

WITH A REAR BAGGER

Optional rear mount grass catcher can affect way tractor is operated. Because of added weight of bagger and extra power required, operate tractor in a lower transmission gear.

⚠ CAUTION ⚠
Exercise care while maneuvering with grass catcher. Front to rear stability could be adversely affected.

Under normal usage, grass catcher bag material is subject to deterioration and wear. It should be checked frequently for bag replacement.

* Average walking speed is 2.5 MPH (4 KPH).

MAINTAINING YOUR TRACTOR

⚠ CAUTION ⚠

To minimize chance of injury, perform all maintenance and adjustments on your tractor with engine off and ignition key removed, unless instructed otherwise in this section. Use extreme care when working near operating machinery. Do not wear loose fitting clothing. Remove watch and jewelry before beginning work and observe common safety practices when using tools.

To check engine oil level, stop tractor where engine is level. Shut off engine and remove key.

Oil drain and oil fill location are illustrated in following photos. Remove oil dipstick from engine. Oil level should be maintained at top of oil range on dipstick. If applicable, add same viscosity oil as is presently in engine. New tractors are shipped with SAE 10w30 oil in crankcase.

Never overfill engine crankcase with oil.

MAINTENANCE CHECKLIST

	Before Each Use	After Each Use	Every 25 Hours	Every 50 Hours	Every 100 Hours	Every 150--200 Hour
NOTE: These service intervals are considered MAXIMUM under normal conditions. Increase frequency under extremely dirty or dusty conditions.						

SERVICE OPERATION

	Before Each Use	After Each Use	Every 25 Hours	Every 50 Hours	Every 100 Hours	Every 150--200 Hour
Check:						
PTO Clutch Adjustment						X
Safety Interlock System	X					
Engine Oil Level	X					
Battery Water Level	X					
Tire Pressures			X			
Brake Adjustment				X		
Tightness of all Attaching Hardware			X			
Valve Clearance ⁽²⁾					X	
Clean Engine Cooling Fins		X				
Clean Air Filter			X			
Lubricate Chassis & Mower			X			
Change Engine Oil ⁽¹⁾			X			
Inspect Spark Plug				X		
Replace:						
Spark Plug						X
Air Filter						X
Fuel Filter (B&S only)						X
Oil Filter ⁽²⁾					X	

(1) Refer to text for initial service interval for new tractors.

(2) TORO POWER PLUS Engine Only

ENGINE

Oil Quality

For maximum engine protection under all operating conditions use API Service Classification (Briggs & Stratton SC, SD, SE or SF) or (TORO POWER PLUS SF, SF/CC, or SF/CD) oil. These letters may appear on oil can singularly or in combination with other letters.

Oil Level

Form a habit of checking oil level regularly.

Check oil level of engine every time tractor is used. An improper oil level can cause extensive internal damage to engine.

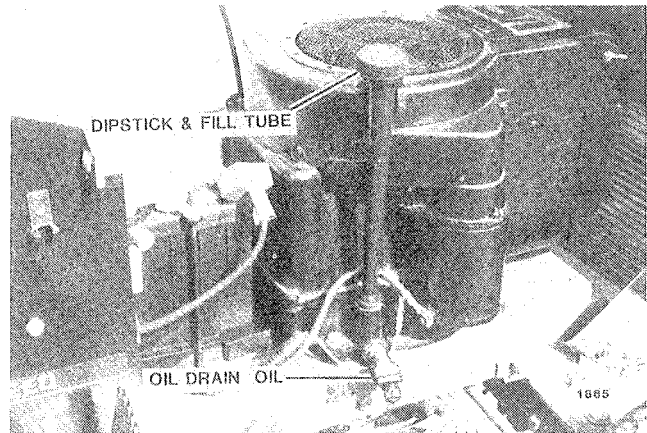

Briggs and Stratton Engine Oil Check, Fill & Drain

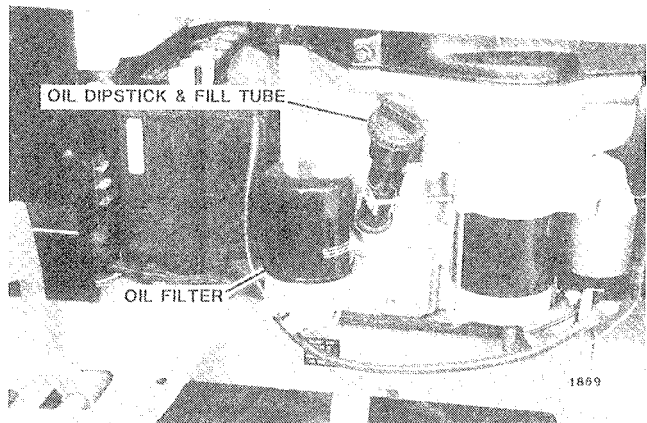

TORO POWER PLUS Engine Oil Check, Fill and Filter

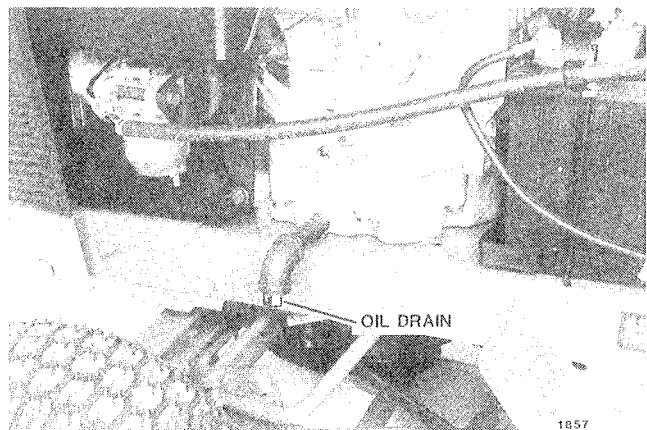

TORO POWER PLUS Engine Oil Drain

Oil Filter

Oil filter should be changed first 50 hrs. and thereafter every 100 hrs. If operating conditions are extremely dusty, frequency of oil filter changes should be increased.

Oil Changes

Engine oil in new tractor should be changed after first 5 hours of operation. Thereafter, oil should be changed at 25 operating hour intervals. If operating conditions are extremely dusty, frequency of oil changes should be increased.

Failure to change engine oil at recommended intervals can lead to serious engine damage. This is especially true when using detergent oils which are designed to hold impurities in suspension; when saturation point is reached, oil may suddenly break down to form a gelatin-like substance which seriously impairs and can even stop the flow of oil. Increase frequency of oil changes if tractor is operated under extremely dusty conditions.

Before changing oil, start engine and allow it to warm up. This will help oil flow more freely. Shut off tractor and remove ignition key.

Open oil drain. Location of oil drain plug is shown in "Oil Level" section of this manual. After oil has drained completely reinstall drain plug.

Remove oil dipstick and add about 80% of amount of oil specified in following chart. Also shown are charts for selecting correct oil type and oil viscosity. When using temperature-viscosity chart, select air temperature most likely to be encountered within next 25 hours of operation.

ENGINE OIL CHANGE

Tractor Model	Crankcase Oil Capacity
210-5	1.5 qts. (1.4 l)
212-5	1.5 qts. (1.4l) w/o Filter
	1.65 qts. (1.55l) w Filter

ENGINE OIL TYPE

Engine

Briggs & Stratton - API Service SC, SD, SE or SF

TORO POWER PLUS - API Service SF/CC OR SF/CD

ENGINE OIL TEMPERATURE - VISCOSITY CHARTS

BRIGGS & STRATTON

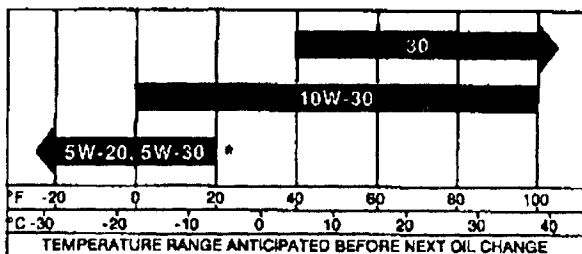

* If not available, a synthetic oil may be used having 5W-20, 5W-30 or 5W-40 viscosity.

TORO POWER PLUS

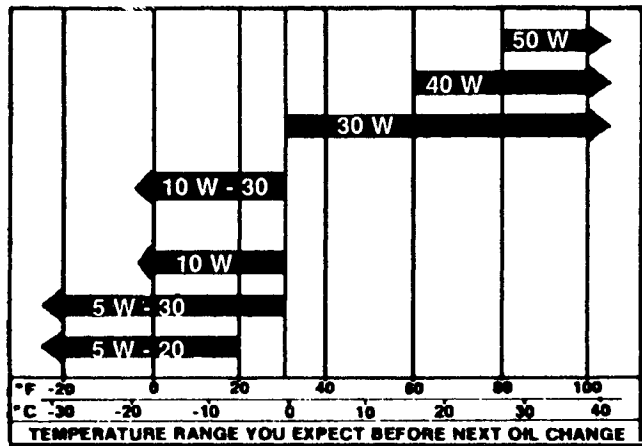

After adding 80% of prescribed amount of oil, check oil level. Add oil as necessary to bring oil to "FULL" mark on dipstick.

Air Filter

Dirt induced through improperly installed, poorly serviced, or inadequate air filter elements, is more often the cause of a worn out engine than long hours of operation. A small amount of dirt will destroy a set of piston rings in a matter of hours. A clogged element causes a richer fuel mixture which wastes gasoline, and may lead to formation of harmful sludge deposits.

Clean engine air cleaner filter after every 25 hours of operation (more frequently if tractor is operated under extremely dusty conditions).

Replace precleaner and dry type element every 150-200 hours or once a year, whichever comes first.

Check following when installing a new or serviced element.

1. Back plate must be securely tightened to carburetor. Replace back plate if distorted or cracked.
2. Gasket surfaces of element must be flat against air filter case and cover to seal effectively.
3. Hardware must be finger tight - do not overtighten. Tighten securely.
4. Be sure cover seals and gaskets, where used, are in good condition and will seal properly. Bad gaskets and seals can let unfiltered air into carburetor.

To prevent any dirt or other contaminants from entering engine, always cover carburetor intake manifold when air cleaner is removed.

To service element, remove cover hardware and lift off cover, precleaner and dry type element. Dry type air filter element is cleaned by tapping it lightly on a flat surface to remove loose dirt particles. If dirt does not drop off easily or if very dirty, replace element. Do not attempt to blow dirt off with compressed air as this can puncture filter element. Do not oil paper element.

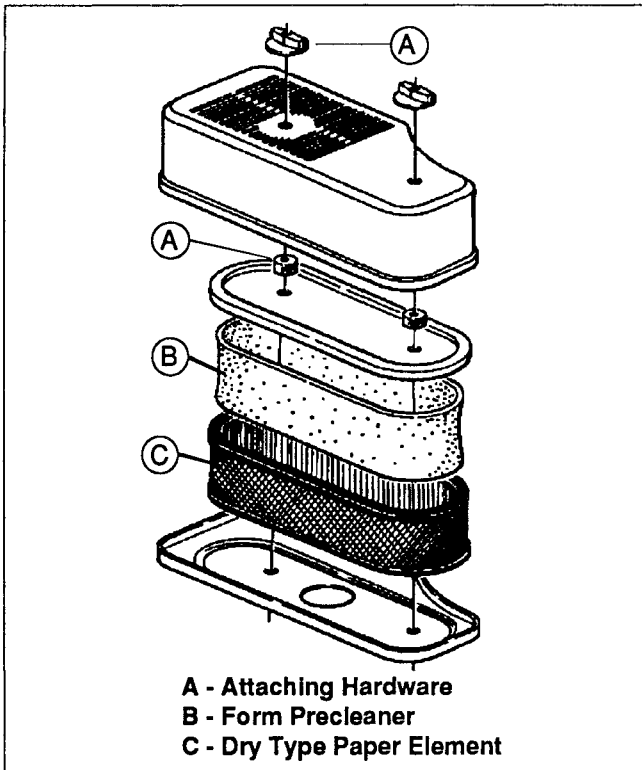

A - Attaching Hardware
B - Foam Pre-cleaner
C - Dry Type Paper Element
Briggs & Stratton Air Filter

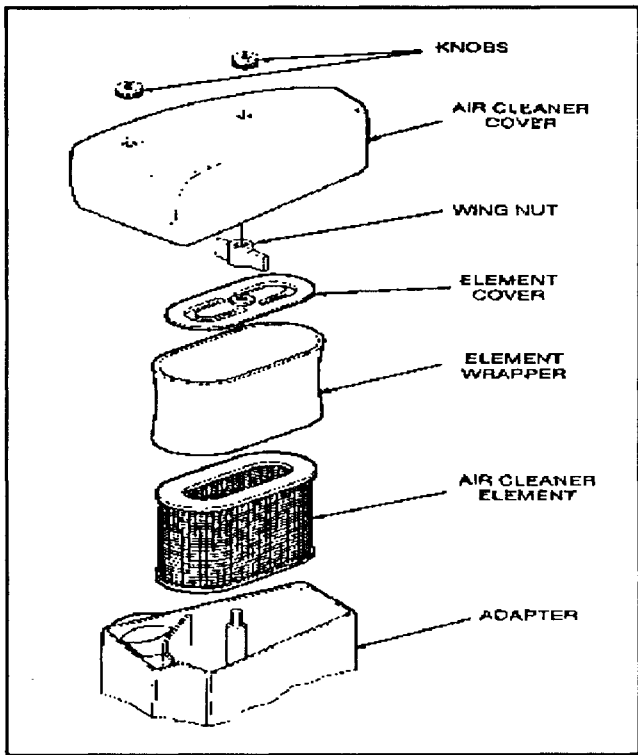

TORO POWER PLUS Air Cleaner

Foam pre-cleaner is used over filter element. Clean when air cleaner is serviced. Wash pre-cleaner in a solution of liquid dishwashing detergent and water. Squeeze out excess water and allow to dry. Saturate pre-cleaner in engine oil, then squeeze out excess oil and install pre-cleaner on element.

Spark Plug

Engine misfire, or generally poor running, is often caused by spark plug in poor condition or incorrect spark plug gap setting. Spark plug should be checked after each 50 hours of operation and replaced after 150-200 hours of operation. Replace a spark plug if inspection reveals fouling or excessive deterioration.

Always clean area around spark plug removing it to prevent dirt from entering engine. Use a spark plug wrench to remove and install plug.

Check condition of plug. Good operating conditions are indicated by a light coating of gray or tan deposit. A dead white, blistered coating could indicate engine overheating. A black coating could indicate an "overrich" fuel mixture caused by a clogged air cleaner, or improper carburetor adjustment.

Replace spark plug that is not in good condition. **Never sandblast, wire brush, scrape or reinstall spark plug in poor condition. Best results are obtained with a new plug.**

Always check spark plug gap before installing new plug or reinstalling original plug.. Use a spark plug gap gauge to adjust electrode air gap to specification for engine.

TRACTOR MODEL	PLUG GAP
210-5 Model.....	.035 in (.88 mm)
212-5 Model.....	.030 in (.76mm)

Tighten spark plug to:

15 ft. lbs. (20Nm)

Carburetor Adjustment

Carburetor is adjusted at factory and should not have to be reset. If a condition is noted as outlined in following "Carburetor Adjustment Chart", carburetor should be readjusted immediately. Continued operation with incorrect carburetor settings can lead to a fouled spark plug, overheating, excessive valve wear or other problems. If black exhaust smoke is noted, check air cleaner first - an "overrich" mixture is usually caused by a poorly serviced, clogged air cleaner element, not an improperly adjusted carburetor.

CONDITION	POSSIBLE CAUSE/PROBABLE REMEDY
A. Black, sooty exhaust smoke, engine sluggish.	A. Mixture too rich - readjust idle or main fuel needle.
B. Engine misses and backfires at high speed.	B. Mixture too lean - readjust idle or main fuel needle.
C. Engine starts, sputters and dies under cold weather starting.	C. Mixture too lean - readjust idle or main fuel needle.
D. Engine runs rough or stalls at idle speed.	D. Idle speed too low or improper idle adjustment - readjust speed then idle fuel needle if needed.

Carburetor Adjustment Chart

Correct carburetor adjustment requires a significant amount of knowledge as well as special equipment, such as a good tachometer. In addition, other adjustments, such as governor settings, may also be necessary after adjusting carburetor. For these reasons, it is suggested that carburetor adjustments be performed by an authorized dealer.

Fuel Filter

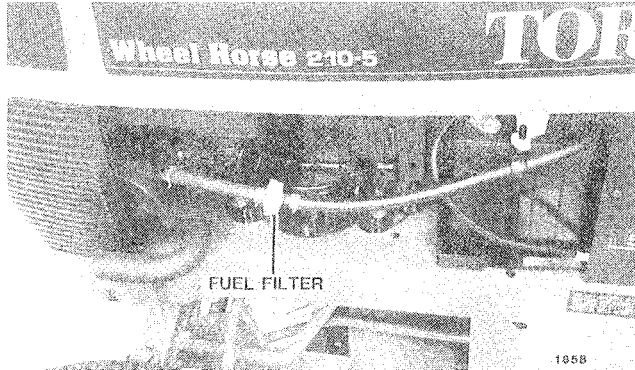

Briggs & Stratton Fuel Filter

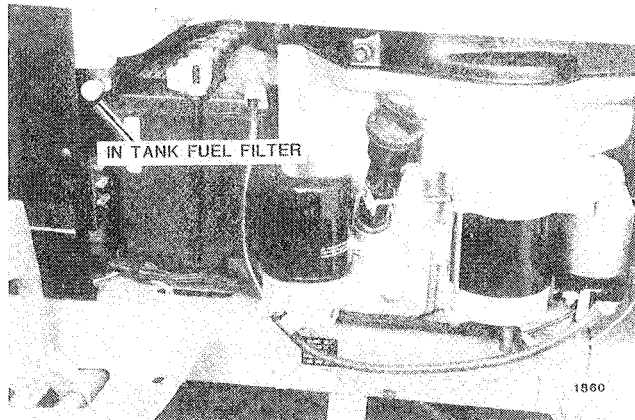

In Tank Fuel Filter

In tank fuel filter is located in bottom of tank. Service is not required unless fuel becomes contaminated.

An in-line fuel filter (Briggs & Stratton only) is located on side of engine. This filter strains foreign particles from gasoline before they reach the carburetor. This filter should be replaced after 150 hours of operation or once a year. Use only manufacturer's filter.

To replace filter:

1. Allow exhaust system to cool.
2. Close fuel shut-off valve.
3. Place a towel or rag on frame below filter to catch any spilled fuel.
4. Replace filter.
5. Open fuel shut-off and check for leaks.

CHARGING AND ELECTRICAL SYSTEMS

Alternator

An alternator is used to charge battery. Alternator

charging system normally requires no service other than periodically checking all exposed wiring and electrical connections on tractor are clean, tight and in good condition.

Proper polarity is critical with an alternator equipped charging system. Always disconnect battery ground cable (negative) before working on any part of the electrical system. Verify all components are connected correctly before reconnecting ground cable (negative) or damage to alternator system components will result.

Never run engine if battery is removed, or if battery is not connected to charging system. Serious damage to voltmeter and charging system components may result.

Main Fuse

Briggs & Stratton Engine

A 25 amp automotive type ATO or ATC fuse is used to protect main circuit of electrical system.

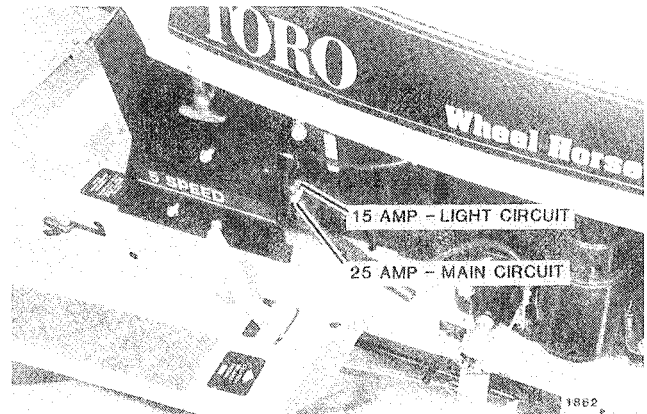

Fuse Location

TORO POWER PLUS Engine

A 25 amp fuse is used to protect main circuit. A 15 amp fuse is used to protect electric PTO clutch. A 30 amp fuse is used to protect battery charging circuit. All fuses are automotive type ATO or ATC.

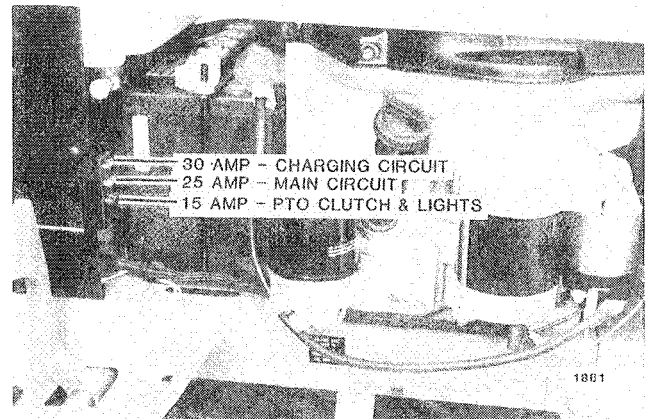

Fuse location

Light Circuit (Not On All Units)

Briggs & Stratton Engine

Electrical system has a separate circuit for operating lights. Alternator output for this circuit is ALTERNATING CURRENT (A.C.) For this reason lights will not operate without engine running. A 15 Amp fuse protects light circuit. Never interconnect A.C. light circuit and D.C. battery circuit as this may result in serious damage to charging system.

TORO POWER PLUS Engine

Light circuit is powered by battery. Lights will operate when ignition switch is in "Run" position. A 15 Amp fuse protects light circuit.

Battery

⚠ CAUTION ⚠

When servicing battery or any other part of electrical system, or if battery must be removed for any reason, always disconnect negative (ground) cable FIRST and reconnect it LAST to avoid possibility of electrical shorts.

Maintain electrolyte level above plates in each cell by adding distilled water as necessary. Best time to add water is just prior to operating machine so water will mix with solution. Do not overfill battery. Electrolyte solution is corrosive and overfilling can cause damage to surrounding metal parts.

Battery should be maintained at 1.265 specific gravity charge. When battery has been removed for servicing, take care to connect cables to battery exactly as they were before removal.

For longest service life, battery should be kept clean by wiping it off with a paper towel. Any corrosion around battery terminals should be removed by applying a solution of one part baking soda to four parts water. A light coating of grease may be applied to all exposed terminal surfaces to prevent corrosion.

At temperatures below 32°F (0°C), full charge state must be maintained to prevent cell electrolyte from freezing and causing permanent battery damage.

Light Bulb Replacement

Headlights are replaced as described below. Care should be taken when handling bulbs, particularly if they are broken. Either headlamp bulb is replaced by disconnecting bulb wires, turn bulb socket counterclockwise and remove socket from hood. Turn bulb counterclockwise and remove bulb from socket. Reverse procedure to install bulb.

MECHANICAL TRANSMISSION

Mechanical transmission is packed with grease and is a sealed unit. No periodic lubricant checks are required; changing lubricant is not necessary except for major service. Refer to Parts and Service manual for capacity and type of lubricant.

CHASSIS LUBRICATION

Spindles, front wheel bearings and front axle pivot are

equipped with fittings to facilitate lubrication with a pressure grease gun. Before applying grease gun, clean zerk fittings carefully to prevent dirt from being forced into fitting. After inserting grease, wipe off any excess grease. A general purpose grease (lithium base) is used to lubricate tractor.

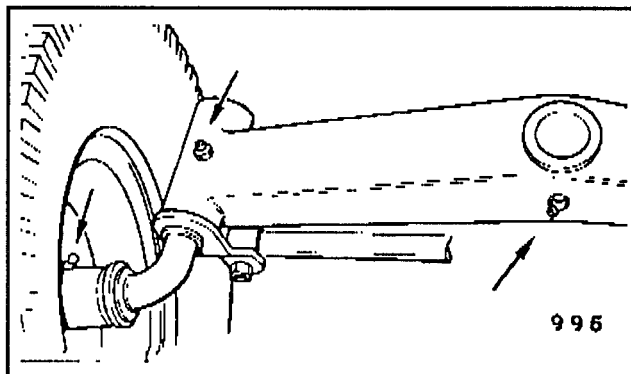

Front Wheel, Spindle and Front Axle Lube Fittings

Lubricate chassis after each 25 hours of operation. All other pivoting arms and levers should be lubricated at same intervals with either general purpose grease or machine oil, applied directly to wear surfaces.

STEERING GEAR TOOTH ADJUSTMENT

1. Remove battery from tractor.

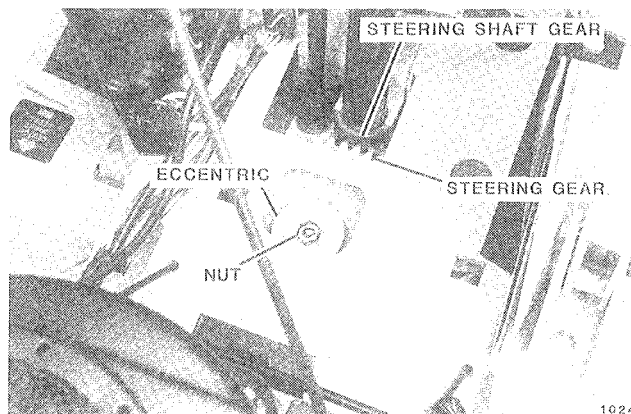

Steering Gear

2. Loosen nut and position steering wheel spokes so that they extend outward, left to right. Tighten nut until eccentric turns with small amount of friction. Turn eccentric counterclockwise until zero clearance is obtained between end of gear tooth and groove of steering shaft pinion gear. DO NOT OVERTIGHTEN. Torque nut to 25-35 lbs.

3. Turn wheels left and right. Recheck for zero clearance. Reinstall battery and gas tank.

GEAR SHIFT LEVER ADJUSTMENT

1. Position transmission in neutral.
2. Remove lock nut from rod end bolt.
3. Position gear shift lever roll pin in bracket neutral stop.
4. Loosen jam nut on control rod and adjust rod end so bolt can be installed into rod end and lever without force. Retighten jam nut and install lock nut on bolt.

5. Position indicator on control handle at neutral marking. Move indicator up on control handle to clear console when handle is pushed down for reverse.

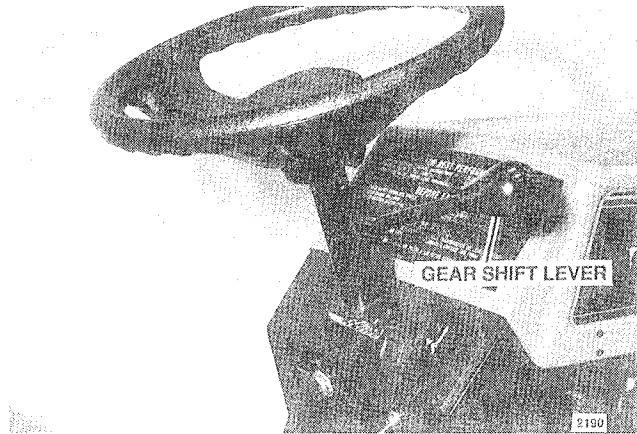

Indicator Adjustment

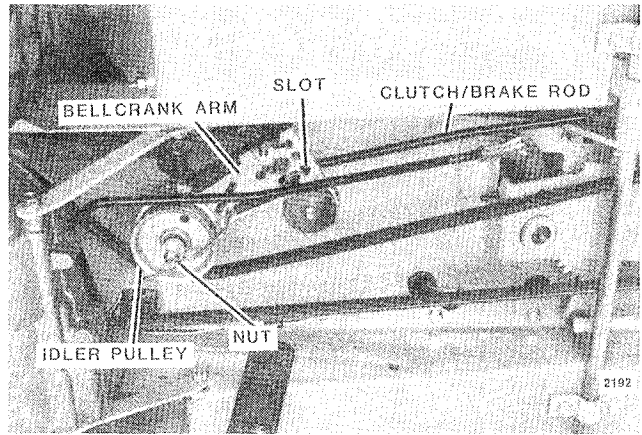

Clutch/Brake Rod and Idler Arm

BRAKE ADJUSTMENT

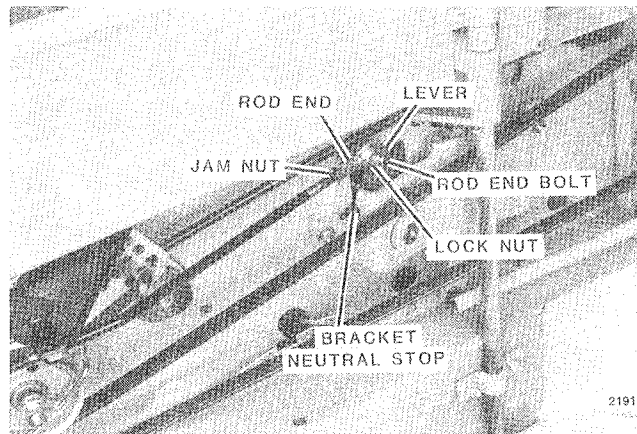

Neutral Adjustment

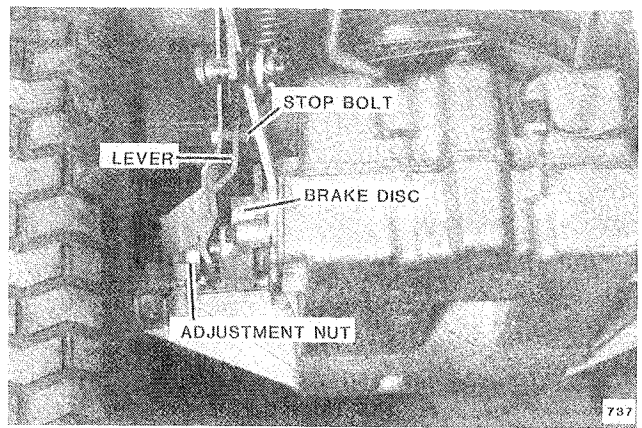

Brake Disc Adjustment

CLUTCH ADJUSTMENT

1. Stop engine and remove ignition key.
2. With clutch/brake pedal released, push pedal forward until clutch/brake rod reaches end of slot in bellcrank arm and begins to disengage bellcrank arm. In this position, parking brake lever should be $\frac{3}{8}$ " - $\frac{1}{2}$ " from end of slot. Loosen nut on idler pulley and slide idler pulley in or out of slot on idler bellcrank to achieve dimension and retighten.

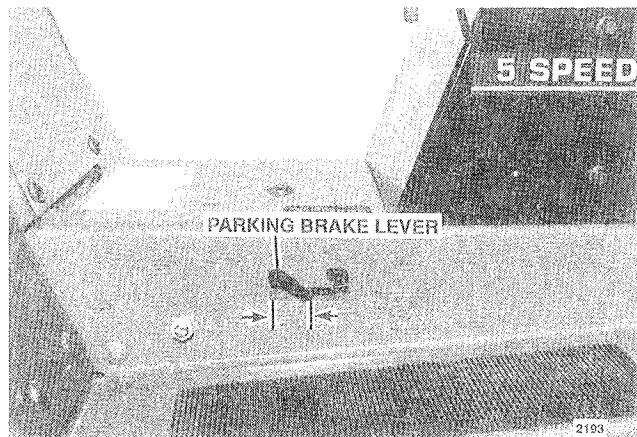

Clutch Adjustment

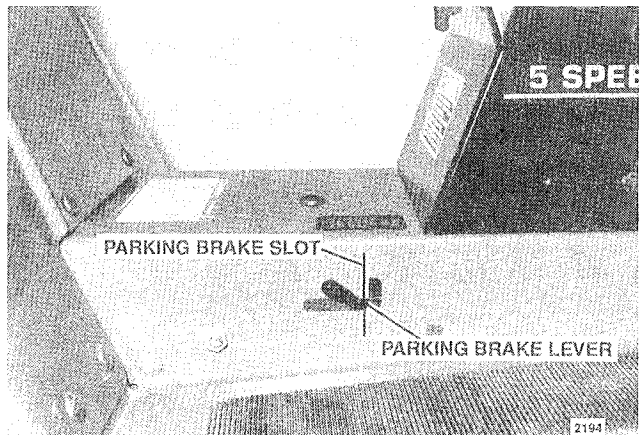

Brake Rod Adjustment

Brake adjustment is made at brake caliper. Block wheels to prevent tractor from rolling and place transmission shift lever in "Neutral" for brake adjustment.

1. Check that transmission brake is contacting bolt when brake is released. If it does not, brake pads will drag on disc while tractor is being operated. If applicable, adjust clutch/brake rod.

2. With clutch/brake pedal released, loosen or tighten adjustment nut until brake disc is no longer free to turn. Back off adjustment nut just enough to permit disc to turn freely.

3. When brake pedal is depressed, brake should be locked when front edge of parking brake lever is even with rear edge of parking brake locking slot in frame. To adjust, rotate eccentric on idler arm underneath tractor.

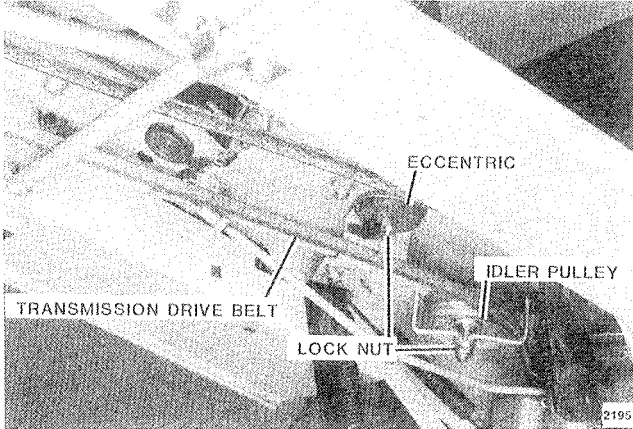

Clutch Idler Pulley and Brake Eccentric Adjustment

DRIVE BELT TENSION ADJUSTMENT

Position fixed idler belt guide 1/8" from back side of drive belt. Loosen bolt and adjust as necessary.

Reposition belt tension spring in different hole until clutch engages firmly without grabbing and moves tractor without slipping.

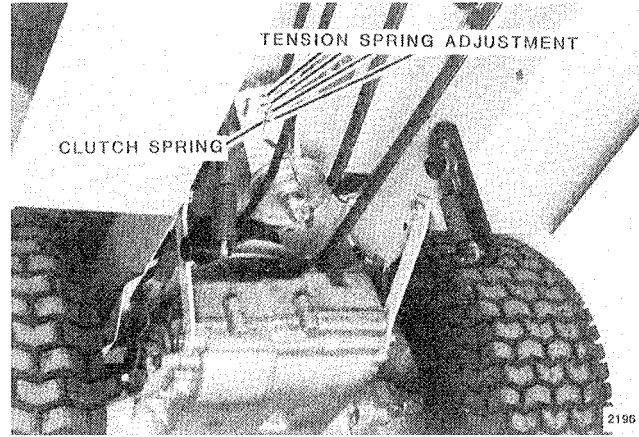

Drive Belt Adjustment

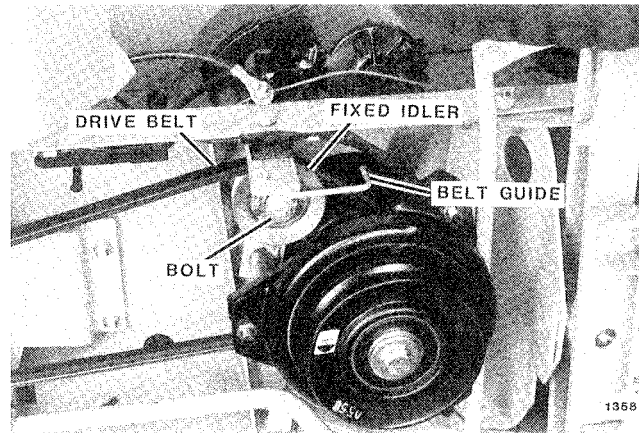

Fixed Idler Belt Guide Adjustment

PTO CLUTCH/BRAKE ADJUSTMENT

PTO clutch/brake must be adjusted every 100 hours due to normal wear of friction surfaces.

1. Stop engine and remove ignition key.
2. Clutch has three springs and adjustment nuts, all three must be adjusted at same interval. Insert a 0.010 inch feeler gauge into slots located next to adjustment nut. Turn until a small amount of resistance is felt on feeler gauge.

NOTE: Equal resistance should be felt in all three slots.

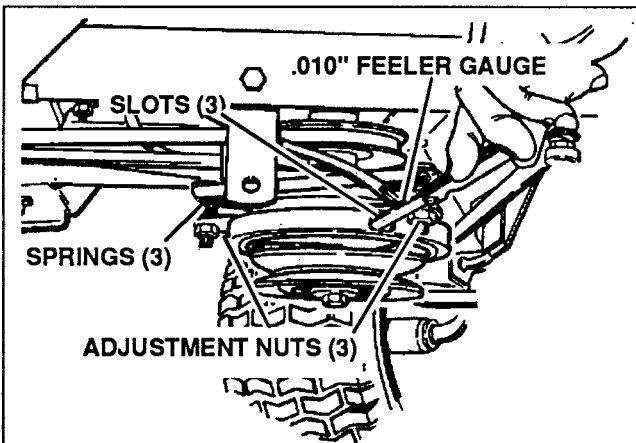

PTO Clutch/Brake Adjustment

CLEANING AND STORAGE

Wash tractor regularly with mild automotive detergent and water. After 30 days, painted surfaces may be waxed to protect original finish.

Minor paint scratches or abrasions can be removed with an automotive cleaning and polishing compound. Rubbing compound is not recommended under normal circumstances, as it is highly abrasive. Exposed bare metal surfaces should be given a light coating of oil or grease to prevent rust until permanent repairs can be made. Aerosol cans of Wheel Horse paint are available through your Authorized Wheel Horse Dealer.

When tractor will not be used for an extended period of time, following steps will help insure minimum difficulty when unit is returned to service:

1. Perform required maintenance steps called for in "Maintenance Checklist".
2. Check tires for proper inflation.
3. Drain all fuel from fuel tank. Start tractor and let engine run out of gas. As gasoline grows old, it becomes less volatile and forms harmful gum and varnish deposits in carburetor and fuel pump. **DO NOT STORE GASOLINE FOR MORE THAN 2 MONTHS.**

4. Wash tractor and repaint all bare metal surfaces.

5. Charge battery. In temperatures lower than 40°F (4°C) a battery will maintain a charge for about 60 days. In temperatures above 40°F (4°C) water level should be checked and battery "trickle charged" every 30 days. Battery must be fully charged to prevent freezing and internal damage in weather be low 32°F (0°C).

6. Remove key from tractor.

TROUBLESHOOTING CHECKLIST

<u>SYMPTOM</u>	<u>POSSIBLE CAUSE</u>	<u>POSSIBLE REMEDY</u>
Engine will not turn over.	Dead battery. Open safety interlock switch. Starter. Solenoid. Ignition switch.	Charge or replace battery. Be sure PTO is disengaged and depress left pedal. Consult authorized dealer. Consult authorized dealer. Consult authorized dealer.
Engine turns over but will not start.	Spark plug not firing. No fuel in tank. Fuel valve closed. Improper carburetor adjustment. Ignition switch.	Check spark plug condition and reset gap. Refuel tractor. Open fuel valve. Reset carburetor adjustment. Consult authorized dealer.
Engine hard to start.	Spark plug wire grounded or loose. Spark plug faulty or improperly gapped. Magneto defective. Fuel line clogged. Carburetor dirty or improperly adjusted.	Check spark plug wires. Check spark plug condition and reset gap. Consult authorized dealer. Clean fuel line; check strainer in fuel tank. Readjust carburetor. Consult dealer for authorized carburetor service.
Engine starts, but operates erratically.	Clogged fuel line. Water in fuel. Vent in fuel cap plugged. Improper carburetor adjustment.	Clean fuel line and check filter; check strainer in fuel tank. Drain old fuel and replace with fresh supply. Check vent. Readjust carburetor.

TROUBLESHOOTING CHECKLIST (Continued)

SYMPTOM	POSSIBLE CAUSE	POSSIBLE REMEDY
Engine knocks.	Fuel octane too low. Faulty Ignition System. Engine overheated.	Drain fuel and replace with higher octane supply. Consult authorized dealer. Shut off engine and allow to cool.
Engine occasionally "skips" at high speed.	Spark plug(s) fouled, faulty or gap too wide. Faulty Ignition System. Incorrect carburetor adjustment.	Check spark plug condition and gap. Consult authorized dealer. Readjust carburetor.
Engine overheating.	Air intake screen or fins clogged Oil level too high or too low. Fuel mixture too lean. Faulty Ignition System. Engine overloaded.	Clean intake screen and fins. Adjust oil level as necessary. Readjust carburetor. Consult authorized dealer. Reduce load on tractor.
Engine idles poorly.	Improper carburetor adjustment. Improper spark plug gap.	Readjust carburetor. Check condition and gap of spark plug(s).
Engine backfires.	Improper carburetor adjustment.	Readjust carburetor.
Engine runs fine, but tractor will not move.	No transmission pressure. Faulty Transmission.	Engage transmission lever. Consult authorized dealer.
Tractor loses power or transmission overheats.	Transmission oil level too high or too low. Transmission damage has resulted from operating engine at low RPM or contamination of oil.	Adjust oil level as necessary. Consult dealer for authorized service.
Engine stalls whenever PTO is engaged.	Excessive load on PTO. Faulty interlock system.	Check for jammed attachments. Lessen load on attachment. Seat must be occupied to close interlock system. Consult authorized dealer.

WIRING DIAGRAM - 212-5

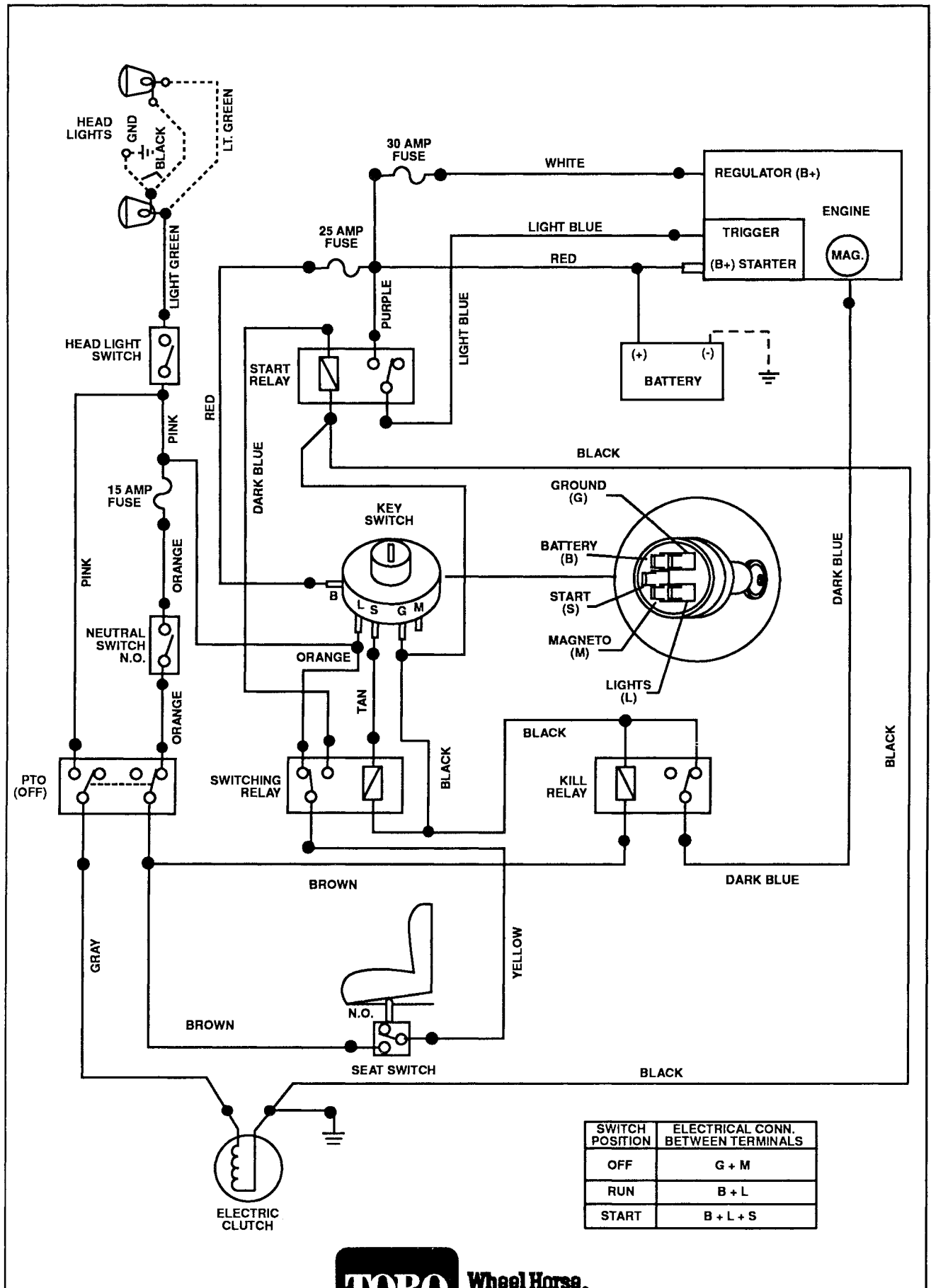

SWITCH POSITION	ELECTRICAL CONN. BETWEEN TERMINALS
OFF	G + M
RUN	B + L
START	B + L + S





Consumer Products

THE TORO TOTAL COVERAGE GUARANTEE

A Full Two-Year Warranty
(Limited Warranty for Commercial Use)

What Is Covered By This Express Warranty?

The Toro Company promises to repair any TORO Product used for residential purposes if defective in materials or workmanship for a period of two years from the date of purchase. The cost of parts and labor are included, but the customer pays the transportation costs.

Transportation within a 15 mile radius of the servicing dealer is covered under this warranty for two-stage snowthrowers, walk behind debris equipment and all TORO Wheel Horse riding products. Walk power mowers, single stage snowthrowers, and other products not specifically covered, are excluded from the transportation coverage provided by this warranty.

What Products Are Covered By This Warranty?

This warranty applies to all gasoline powered Consumer Products (including TORO Wheel Horse riding products). Wide area walk behind mowers, ProLine 118, and 21" Commercial mowers without blade stop controls are covered by separate warranty statements.

How About Commercial Use?

TORO Consumer Products used for commercial, institutional or rental use are covered by a limited warranty for the following time periods from the date of purchase:

Products	Warranty Period
<ul style="list-style-type: none"> 300 through 700 Series Tractors (except 612-Z) and 1600 HMR 	<ul style="list-style-type: none"> Chassis 1 year limited warranty Engine 2 year limited warranty
<ul style="list-style-type: none"> 21" Commercial Duty Walk Mower with blade stop controls . . 	<ul style="list-style-type: none"> 1 year limited warranty
<ul style="list-style-type: none"> 200 Series Tractors, Rear Engine Riders, 612-Z, 1200 HMR 3.0 and 3.5 HP Edgers Straight Shaft Trimmers, and Backpack Blowers . . . 	<ul style="list-style-type: none"> 90 day limited warranty
<ul style="list-style-type: none"> All Others 	<ul style="list-style-type: none"> 45 day limited warranty

How Do You Get Warranty Service?

Should you feel your TORO product contains a defect in material or workmanship, contact the dealer who sold you the product or any Authorized TORO Service Dealer or TORO Master Service Dealer. The Yellow Pages of your telephone directory is a good reference source. The dealer will either arrange service at his/her dealership or recommend another Authorized Service Dealer who may be more convenient. You may need proof of purchase (copy of registration card, sales receipt, etc.) for warranty validation.

If for any reason you are dissatisfied with the Service Dealer's analysis of the defect in materials or workmanship or if you need a referral to a TORO Service Dealer, please feel free to contact us at the following address:

Toro Customer Service Department
8111 Lyndale Avenue South
Minneapolis, MN 55420
612-888-8801

What Must You Do To Keep The Warranty In Effect?

You must maintain your TORO Product by following the maintenance procedures described in the operator's manual. Such routine maintenance, whether performed by a dealer or by you, is at your expense.

What Does This Warranty Not Cover? and

How Does Your State Law Relate To This Warranty?

There is no other express warranty except the TORO Starting Guarantee on GTS Engines. This express warranty does not cover:

- Cost of regular maintenance service or parts, such as filters, fuel, lubricants, tune-up parts, blade sharpening, brake and clutch adjustments.
- Any product or part which has been altered or misused or required replacement or repair due to normal wear, accidents, or lack of proper maintenance.
- Repairs necessary due to improper fuel, contaminants in the fuel system, or failure to properly prepare the fuel system prior to any period of non-use over three months.
- Pickup and delivery charges for distances beyond a 15 mile radius from an Authorized TORO Service Dealer (covered products only).

All repairs covered by this warranty must be performed by an Authorized TORO Service Dealer using Toro approved replacement parts.

Repair by an Authorized TORO Service Dealer is your sole remedy under this warranty.

The Toro Company is not liable for indirect, incidental or consequential damages in connection with the use of the TORO Products covered by this warranty, including any cost or expense of providing substitute equipment or service during reasonable periods of malfunction or non-use pending completion of repairs under this warranty. Some states do not allow exclusions of incidental or consequential damages, so the above exclusion may not apply to you.

This warranty gives you specific legal rights, and you may also have other rights which vary from state to state.

10° SLOPE CHART

ALIGN THIS EDGE WITH A VERTICAL SURFACE
(TREE, BUILDING, FENCEPOST, POLE ETC.)

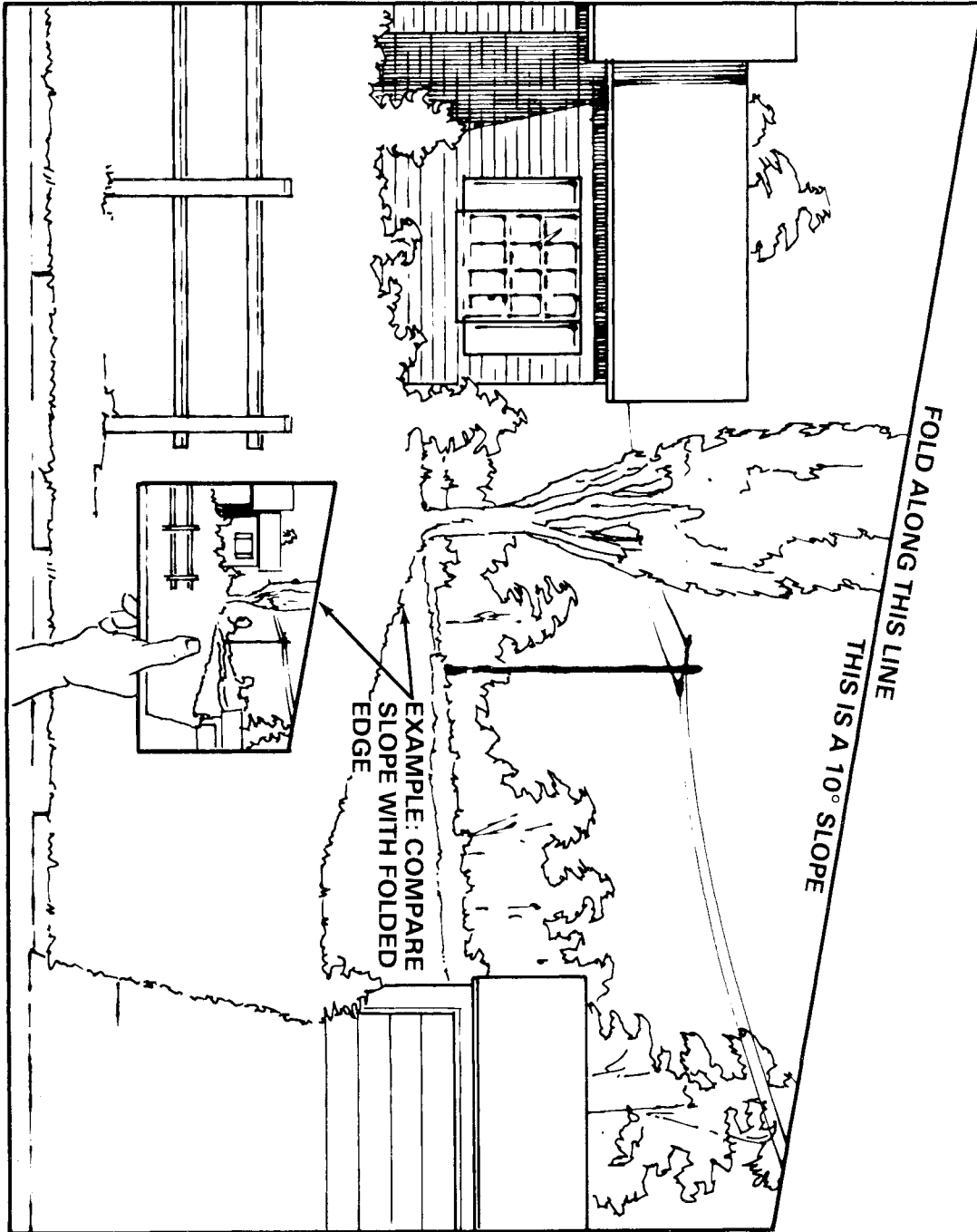

Your TORO Wheel Horse
does more at home when it's equipped
with TORO Wheel Horse attachments.

Product information and specifications are shown herein as of the time of printing. Toro Wheel Horse reserves the right to change product specifications, designs and standard equipment without notice and without incurring obligation.

Right at home.



Wheel Horse
Tractors & Riding Mowers