



Count on it.

Parts Catalog

**12in Cordless Single-Line
Trimmer**

Model No. 51487—Serial No. 314000001 and Up



Ordering Replacement Parts

To order replacement parts, please supply the part number, the quantity, and the description of each part desired.

Understanding Reference Numbers

Each identified part in an illustration has a reference number. The reference number for a part also appears in the parts list, along with other information about the part.

This catalog uses two special reference number formats, one to indicate parts in a service assembly and another to indicate the quantity of a given part in an illustration.

Service Assembly Reference Numbers

Parts in service assemblies have reference numbers in the form a:b. The a represents the reference number of the entire service assembly and the b represents a sequential number unique to each part within the service assembly.

For example, a wheel assembly might be identified by reference number 6, the tire by 6:1, the valve by 6:2, and the wheel by 6:3. When you order the assembly identified by reference number 6, you receive all parts identified by reference numbers 6:1, 6:2, and 6:3. However, you may also order any part individually. Reference numbers of this type appear in illustration and in parts lists.

Reference Numbers Indicating Quantity

In an illustration, if a reference number indicates more than one part, the reference number has the form nX y. The n represents the quantity of the part, the X is the multiplication symbol, and the y represents the reference number.

For example, in an illustration, the reference number 2X 37 means that two of the parts identified by reference number 37 are indicated.

List of Abbreviations

AR: as required	HLH: hex lag head	PTO: power-take-off
ASM: assembly	HOC: height-of-cut	RH: right hand
BBC: blade brake control	HSBH: hex socket button head	ROPS: roll-over protection system
BHTF: button head thread forming	HSFH: hex socket flat head	RRB: rear roller brush
CARR: carriage	HSH: hex socket head	SFH: slotted fillister head
CCW: counter clockwise	HWH: hex washer head	SHH: slotted hex head
CW: clockwise	HWHTF: hex washer head thread forming	SHWH: slotted hex washer head
DEG: degrees	HYD: hydraulic	SPH: slotted pan head
DPA: Dual Point Adjustment	LH: left hand	SQH: square head
ECM: electronic control module	LP: Liquefied Petroleum Gas	SRH: slotted round head
EXT: external	LPG: Liquefied Petroleum Gas	STD: standard
FH: flat head	NI: nylon insert	TAP: self tapping
GA: gauge	NPTF: national pipe thread fine	TTH: torx truss head
HD: heavy-duty	PFH: phillips flat head	
HF: hex flange	PPH: phillips pan head	
HH: hex head	PPHTF: phillips pan head thread forming	
HHF: hex head flange	PRH: phillips round head	
HHFTF: hex head flange thread forming	PTH: phillips truss head	
HJ: hex jam		

Contents

12in Cordless Single-Line Trimmer Assembly	4
Attachments and Accessories	6

12in Cordless Single-Line Trimmer Assembly

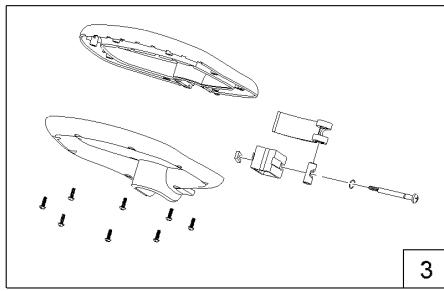

3

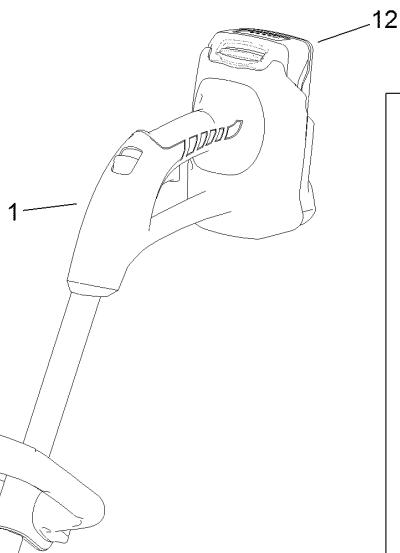

1

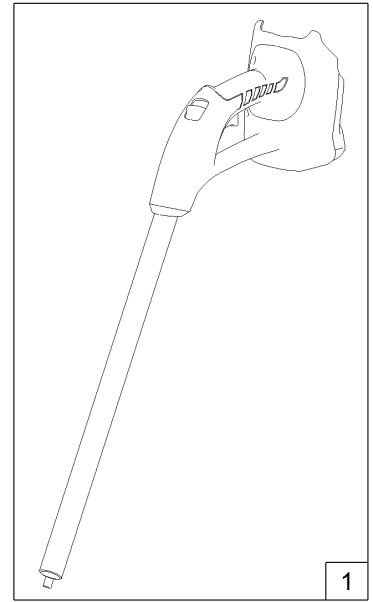

1

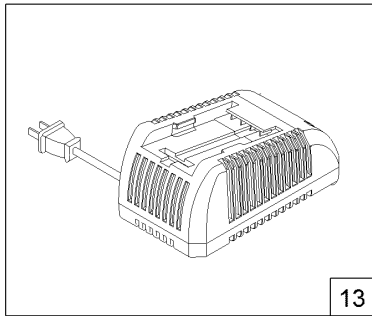

13

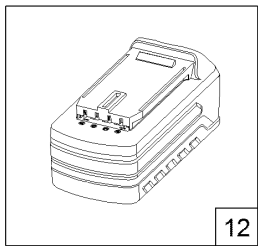

12

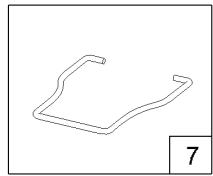

7

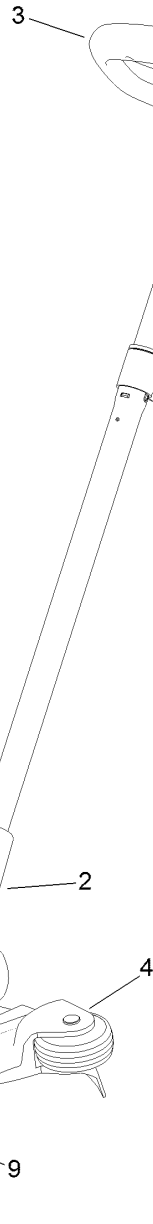

3

2

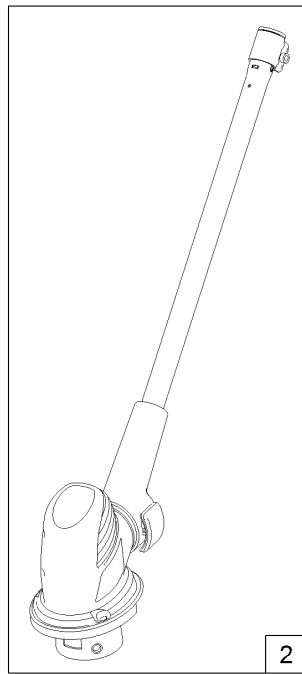

2

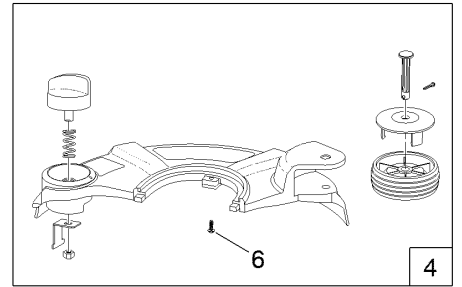

4

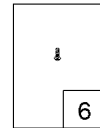

6

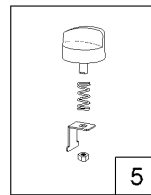

5

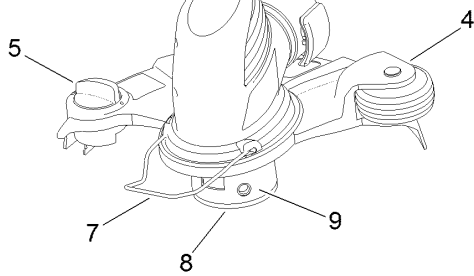

5

4

7

8

9

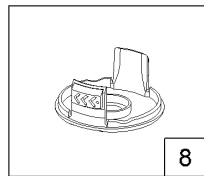

8

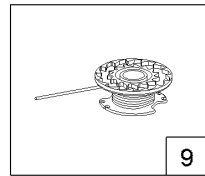

9

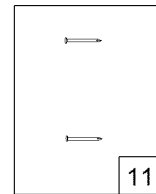

11

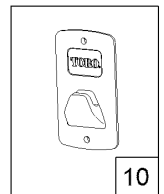

10

12in Cordless Single-Line Trimmer Assembly (continued)

<i>Ref.</i>	<i>Part Number</i>	<i>Qty.</i>	<i>Description</i>	<i>Ref.</i>	<i>Part Number</i>	<i>Qty.</i>	<i>Description</i>
1	125-8290	1	Handle-Upper	8	125-8252	1	Cap-Retainer, Spool
2	125-8291	1	Housing-Motor, Lower	9	88532	1	Spool-Replacement
3	125-8261	1	Assist Handle ASM	10	125-8260	1	Bracket-Mount, Wall
4	121-7624	1	Shield ASM	11	125-8259	2	Screw (Wall Mount Bracket)
5	125-8292	1	Knob-Saver, Power	12	88506	1	Battery-Li-Ion, 24V Max
6	125-8293	1	Screw	13	88503	1	Charger-24V, Li-Ion
7	125-8251	1	Clip-Guide, Edger				

Attachments and Accessories

For 51487 12in Cordless Single-Line Trimmer

Product Name	Model/Part
24in Cordless Hedge Trimmer (without Battery and Charger)	51496T
Hand-Held Sweeper Blower (without Battery and Charger)	51702T
24V Li-Ion Battery Charger	88503
24V Li-Ion Extended Range Battery Pack.....	88504
24V Li-Ion Standard Battery Pack.....	88506
Spool-3 Pak	88524
Spool	88532

Notes:



Count on it.