



TRACTION UNIT MODEL:
30787 — 80001 & UP

**OPERATOR'S
MANUAL**

GROUNDMASTER® 327
WITH POWER STEERING



The GROUNDMASTER 327 conforms to the American National Standards Institute's safety standards for riding mowers; thus, Toro proudly displays this compliance seal.

To assure maximum safety, optimum performance, and to gain knowledge of the machine, it is essential that you or any other operator of the machine read and understand the contents of this manual before the engine is started. Pay particular attention to the instructions highlighted by the triangular safety alert symbol. Failure to comply with the safety instructions may result in personal injury.



FOREWORD

The GROUNDMASTER 327 was developed to satisfy the demand for a maneuverable, intermediate size, turf maintenance rotary mower. The machine has advanced concepts in engineering, and design; and if maintained properly, it will give excellent service.

Since the GROUNDMASTER 327 is a high-quality product, Toro is concerned about the future use of the machine and safety of the user. Therefore, read this manual to familiarize yourself with proper set-up, operation and maintenance instructions. The major sections of the manual are:

1. Safety Instructions
2. Set-Up Instructions
3. Before Operating
4. Operating Instructions
5. Maintenance

The engine and axle are not covered in great detail in this manual. However, some service information, unique to the GROUNDMASTER 327, is contained in this manual. All other engine and axle information is in the manuals supplied by the respective manufacturer.

A hydrostatic axle service manual (bulletin no. 5323) can be obtained from:

Dana Corporation
P.O. Box 2229
Fort Wayne, Indiana 46801

A hydrostatic transmission service manual (bulletin no. 9646) and a repair manual (bulletin no. 9659) can be obtained from:

Sundstrand Corporation
2800 East 13th Street
Ames, Iowa 50010

Certain information in this manual is emphasized. DANGER, WARNING and CAUTION identify personal safety-related information. IMPORTANT identifies mechanical information demanding special attention. Be sure to read the directive because it deals with the possibility of damaging a part or parts of the machine. NOTE identifies general information worthy of special attention.

OPTIONAL SPARK ARRESTOR

In some areas there are local, state or federal regulations requiring that a spark arrestor be used on the engine of this mower. If a spark arrestor is required, order the following parts from your local Toro Distributor:

- (1) Spark Arrestor, part no. 36-3190
- (1) Clamp, part no. 2112-9

These parts are approved by the United States Department of Agriculture Forestry Service. The approval number for the exhaust system is U49114.

When mower is used or operated on any California forest, brush or grass covered land, a working order spark arrestor must be attached to muffler. If not, the operator is violating state law, Section 4442 Public Resources Code.

If help concerning set-up, operation, maintenance or safety is ever needed, contact the local Authorized TORO Distributor. In addition to genuine TORO replacement parts, the distributor also has optional equipment for the complete line of TORO turf care equipment. Keep your Toro all TORO. Buy genuine TORO replacement parts and accessories.

TABLE OF CONTENTS

	Page		Page
SAFETY INSTRUCTIONS	4-5	Changing Coolant in Cooling System . . .	30
SAFETY AND INSTRUCTION DECALS	5-6	Adjusting Governor	31
SPECIFICATIONS	6-7	Checking Oil Level in Governor	32
LOOSE PARTS	8	TRACTION DRIVE MAINTENANCE	32-34
SET-UP INSTRUCTIONS	9-13	Adjusting Traction Control Rod	32
BEFORE OPERATING	14-15	Adjusting Traction Pedal Friction Wheel	32
Check Crankcase Oil	14	Adjusting Traction Drive For Neutral	32
Fill Fuel Tank With Gasoline	14	Adjusting Traction Interlock Switch	33
Check Cooling System	15	Removing Drive Coupling	33
Check Hydraulic System Oil	15	Installing Drive Coupling	34
CONTROLS	16-17	Checking Drive Coupling Alignment	34
OPERATING INSTRUCTIONS	18-19	PTO DRIVE MAINTENANCE	35
Starting/Stopping Instructions	18	Replacing PTO Drive Belt	35
Checking Interlock Switches	18	Adjusting PTO Brake	35
Pushing Or Towing Traction Unit	18	Replacing PTO Brake	35
Operating Characteristics	19	Aligning PTO Pulley And Engine Pulley	35
LUBRICATION MAINTENANCE	20-21	STEERING MAINTENANCE	36-37
ELECTRICAL MAINTENANCE	22-27	Adjusting Rear Wheel Toe-In	36
Electrical Troubleshooting	22-26	Adjusting Rear Wheel Bearings	37
Wiring Schematic	26	BRAKE MAINTENANCE	37-38
Replacing Seat Switch	27	Adjusting Brakes	37-38
Replacing PTO Switch	27	HYDRAULIC SYSTEM MAINTENANCE	39-48
Servicing Battery	27	Forward Traction Operation	39
AIR CLEANER MAINTENANCE	28-29	Reverse Traction Operation	40
General Maintenance Practices	28	Lifting Operation	41
Servicing Dust Cup and Baffle	28	Troubleshooting	42-45
Servicing Air Cleaner Filter	28	Adjusting Lift Lever	46
Inspecting Filter Element	29	Replacing Lift Arm Bushings	46
ENGINE MAINTENANCE	29-32	Checking Hydraulic Cylinder For Hold	46
Cleaning Radiator and Screen	29	Replacing Hydraulic Cylinder	47
Replacing Fuel Filter	29	Replacing Hydraulic Oil Filter	47
Adjusting Idle Speed	29	Changing Hydraulic System Oil	48
Adjusting Choke	30	IDENTIFICATION AND ORDERING	48
Adjusting Choke Idle Speed	30	PREPARATION FOR SEASONAL	
Checking Engine Timing	30	STORAGE	49
Adjusting Valve Tappet and Tightening		SERVICE INTERVAL CHART	50-51
Cylinder Head Capscrews	30	THE TORO PROMISE	52



SAFETY INSTRUCTIONS

The GROUNDMASTER 327 was tested and certified for compliance with the B71.4 - 1984 specifications of the American National Standards Institute. However, improper use or maintenance of the machine can result in injury. To reduce the potential for injury, comply with the following safety instructions.

BEFORE OPERATING

1. Read and understand the contents of this manual before starting and operating the machine. Become familiar with all controls and know how to stop quickly. A free replacement manual is available by sending complete Model and Serial Number to:

The Toro Company
8111 Lyndale Avenue South
Minneapolis, Minnesota 55420

2. Do not allow children to operate the machine. Do not allow adults to operate the machine without proper instruction.

3. Remove all debris or other objects that might be picked up and thrown by cutter blades or fast moving components from other attached implements. Keep all bystanders away from the operating area.

4. Keep all shields and safety devices in place. If a shield, safety device or decal is defective or damaged, repair or replace it before operation is commenced. Also tighten any loose nuts, bolts and screws to ensure machine is in safe operating condition.

5. Do not wear loose fitting clothing because it could get caught in moving parts. Always wear long pants and substantial shoes. Wearing safety glasses, safety shoes and a helmet is advisable and required by some local ordinances and insurance regulations.

6. Assure interlock switches are adjusted correctly so engine cannot be started unless traction pedal is released — neutral position — and PTO lever is in OFF position.

7. Fill fuel tank with gasoline before starting the engine. Avoid spilling any gasoline. Since gasoline is flammable, handle it carefully.

- A. Use an approved gasoline container.
- B. Do not fill fuel tank when engine is hot or running.
- C. Do not smoke while handling gasoline.

D. Fill fuel tank outdoors and up to about one inch (25 mm) from the top of the tank, not the filler neck.

E. Wipe up any spilled gasoline.

WHILE OPERATING

8. Sit on the seat when starting the engine and operating the machine.

9. Before starting the engine:

A. Engage parking brake.

B. Make sure traction pedal is in neutral and PTO is in OFF, disengage position.

C. After engine is started, release parking brake and keep foot off traction pedal. Machine must not move. If movement is evident, the neutral return mechanism is adjusted incorrectly; therefore, shut engine off and adjust until machine does not move when traction pedal is released.

10. Do not run the engine in a confined area without adequate ventilation. Exhaust fumes are hazardous and could possibly be deadly.

11. Maximum recommended seating capacity is one person. Therefore, never carry passengers.

12. Using the machine demands attention, and to prevent loss of control:

A. Operate only in daylight or when there is good artificial light.

B. Watch for holes or other hidden hazards.

C. Do not drive close to a sand trap, ditch, creek or other hazard.

D. Reduce speed when making sharp turns and when turning on a hillside.

E. Avoid sudden stops and starts.

13. Traverse slopes carefully when implement is attached. Do not start or stop suddenly when traveling uphill or downhill.

14. The grass deflector must always be installed and in lowest position on the cutting unit. If the cutting unit discharge area ever plugs, disengage PTO and shut engine off before removing the obstruction.

15. Never raise the cutting unit or other attached implement while the blades or other parts are rotating.



SAFETY INSTRUCTIONS

16. If cutting blades or other implement components strike a solid object or the machine vibrates abnormally, disengage PTO, move throttle to SLOW, set parking brake and shut engine off. Remove key from switch and pull high tension wire off the coil to prevent possibility of accidental starting. Check cutting unit or other implement and traction unit for damage and defective parts. Repair any damage before restarting the engine and operating the implement or cutting unit. Be sure cutting unit blades are in good condition and blade bolts are tight.

17. Do not touch engine, muffler or radiator while engine is running or soon after it is stopped. These areas could be hot enough to cause a burn.

18. Lower the cutting unit or other attached implement to the ground and remove key from switch whenever machine is left unattended.

19. Before getting off the seat:

- A. Move traction pedal to neutral position and remove foot from pedal.
- B. Set the parking brake and disengage the PTO.
- C. Shut the engine off and remove key from ignition switch. Wait for all movement to stop before getting off the seat.

MAINTENANCE

20. Remove key from ignition switch and disconnect high tension wire from coil to prevent accidental starting of the engine when servicing, adjusting or storing the machine.

21. If major repairs are ever needed or assistance is desired, contact an Authorized TORO Distributor. Ask about Mobile Service Maintenance.

22. To reduce potential fire hazard, keep the engine free of excessive grease, grass, leaves and accumulations of dirt.

23. Make sure machine is in safe operating condition by keeping nuts, bolts and screws tight. Check all cutting unit blade mounting bolts frequently to assure they are tight; 75 to 100 ft-lb (102 to 136 N·m).

24. Make sure all hydraulic line connectors are tight, and all hydraulic hoses and lines are in good condition before applying pressure to the system.

25. Keep body and hands away from pin hole leaks or nozzles that eject hydraulic fluid under high pressure. Use paper or cardboard, not hands, to search for leaks. Hydraulic fluid escaping under pressure can have sufficient force to penetrate skin and do serious damage. If fluid is ejected into the skin it must be surgically removed within a few hours by a doctor familiar with this form of injury or gangrene may result.

26. Before disconnecting or performing any work on the hydraulic system, all pressure in system must be relieved by stopping engine and lowering implement to the ground.

27. If the engine must be running to perform maintenance or an adjustment, keep clear of PTO shaft, cutting unit blades and other moving parts.

28. Do not overspeed the engine by changing the governor settings. Maximum engine speed with no load is 3300 rpm. To insure safety and accuracy, have an Authorized TORO Distributor check maximum engine speed with a tachometer.

29. Engine must be shut off before checking oil or adding oil to the crankcase.

30. At the time of manufacture, the machine conformed to safety standards in effect for riding mowers. To assure optimum performance and continued safety certification of the machine, use genuine TORO replacement parts and accessories. Replacement parts and accessories made by other manufacturers may result in non-conformance with the safety standards, and the warranty may be voided.

SAFETY AND INSTRUCTION DECALS

The following safety and instruction decals are mounted on the traction unit. If any decal becomes damaged or illegible, install a new decal. Part numbers are listed below and in your parts catalog.

STARTING INSTRUCTIONS 1. Disengage power take-off. 2. Place traction drive pedal in neutral position. 3. Depress brake pedal. 4. Set choke and throttle controls as required. (See Operator's Manual) 5. Turn key to start position. To stop turn key to off position and remove key.	NOTE: ENGINE WILL SHUT OFF AUTOMATICALLY DUE TO HIGH ENGINE TEMPERATURE. WHEN THIS HAPPENS: 1. Allow engine to cool. 2. Clean debris from front of radiator. 3. Check coolant level. Caution: Coolant under pressure. Use caution when removing radiator cap to prevent burns. 4. Depress high temperature reset on dash. 5. Restart according to starting instructions.
---	--

READ AND UNDERSTAND OPERATORS MANUAL BEFORE OPERATING THIS MACHINE. REPLACEMENT MANUAL AVAILABLE BY SENDING COMPLETE MODEL NUMBER TO: THE TORO COMPANY, 8111 LYNDALE AVE., MINNEAPOLIS, MINN. 55420

ON BATTERY COVER
(Part No. 27-7280)

WARNING
PUSH ARMS ARE SPRING LOADED!
 SEE OPERATORS MANUAL FOR DISASSEMBLY PROCEDURE

ON PUSH ARMS
(Part No. 36-4060)

WARNING
THIS ARM CAN SPRING UPWARD!
 SEE OPERATORS MANUAL FOR DISASSEMBLY PROCEDURE.

ON LIFT ARM
(Part No. 61-3610)

SAFETY AND INSTRUCTION DECALS

CAUTION

- KEEP ALL SHIELDS IN PLACE.
- BEFORE LEAVING OPERATORS POSITION:
 - MOVE TRANSMISSION TO NEUTRAL.
 - SET PARKING BRAKE.
 - DISENGAGE POWER TAKE-OFF.
 - SHUT OFF ENGINE.
 - REMOVE IGNITION KEY.
- WAIT FOR ALL MOVEMENT TO STOP BEFORE SERVICING MACHINE.
- STOP ENGINE BEFORE ADDING FUEL OR LIFTING HOOD.
- KEEP PEOPLE AND PETS A SAFE DISTANCE AWAY FROM MACHINE.

NEAR PTO LEVER
(Part No. 27-7290)

- DEPRESS BRAKE PEDAL.
- PULL KNOB TO LOCK.

TO UNLOCK: DEPRESS BREAK PEDAL.

PARKING BRAKE

ON STEERING COLUMN SUPPORT
(Part No. 66-6190)

TRACTION PEDAL INSTRUCTIONS

VEHICLE SPEED INCREASES WITH MORE PEDAL PRESSURE.

IMPORTANT
USE FLOAT POSITION WHEN TRAILERING THIS UNIT

CAUTION
TURN OFF PTO BEFORE RAISING IMPLEMENT TO TRANSPORT POSITION.
DO NOT OPERATE IMPLEMENT IN TRANSPORT POSITION.

LIFT CONTROL

FLOAT

NEAR LIFT LEVER
(Part No. 66-6390)

TRANSPORT

RAISE

66-6390

CAUTION
ROTATING MEMBER

ON RADIATOR FAN SHROUD
(Part No. 54-0890)

OIL PRESSURE

CHOKE

THROTTLE

FAST

SLOW

OFF

START

TEMP

SHUT-OFF

PUSH TO RESET

ON CONTROL PANEL
(Part No. 40-4400)

1 INCH (25 MM)

CAUTION
FILL FUEL TANK TO 1 INCH BELOW FILLER NECK.
DO NOT OVERFILL.

NEAR FUEL TANK CAP
(Part No. 27-7310)

1 INCH (25mm)

IMPORTANT
FILL RADIATOR TO 1 INCH BELOW FILLER NECK.
DO NOT OVERFILL.
USE 50-50 SOLUTION OF WATER AND ETHYLENE GLYCOL TYPE ANTI-FREEZE.

UNDER HOOD ABOVE RADIATOR CAP
(Part No. 26-7530)

CAUTION

CHECK PERFORMANCE OF ALL INTERLOCK SWITCHES DAILY. SEE OPERATOR'S MANUAL FOR INSTRUCTION. DO NOT DEFEAT INTERLOCK SYSTEM. IT IS FOR YOUR PROTECTION.

NEAR TOOL BOX COVER
(Part No. 67-1710)

SPECIFICATIONS

Engine: The 4-cycle, 4 cylinder, in-line overhead valve Continental engine, model R08-D15-2002, is water-cooled, and 27 hp. Cylinder bore is 2.28 inches, stroke is 3.14 inches and displacement is 51.6 cubic inches. Compression ratio is 8.5:1. Crankcase oil capacity is 3 quarts (2.8 L) w/filter. Filter is replaceable, screw on, full flow type. Cast iron cylinder liners are replaceable, wet type. Solex down draft carburetor has manual choke. Mechanical governor limits maximum no-load engine speed to 3300 rpm, and recommended idle speed is 1500 rpm.

Air Cleaner: Heavy duty, remote mounted.

Muffler: Large muffler has provisions for adding spark arrestor.

Cooling System: Radiator has tube and fin construction with hydraulic oil cooler in lower tank. Capacity of cooling system is approximately 6 quarts (5.7 L) of a 50% mixture of permanent, ethylene glycol anti-freeze and water. Radiator is equipped with a 15 psi (108.4 kPa) pressure cap and engine has a 183° F (84° C) thermostat.

Electrical: The 12 volt battery has 42 plates and is rated at 45 ampere hours. A 30 amp alternator and regulator are standard.

SPECIFICATIONS

Fuel Tank: Capacity is approximately 8-1/2 gallons (32 L) of leaded regular or lead-free gasoline.

Front Axle: The heavy Duty Dana GT 20 axle has reduction of 20.9:1. Axle has automotive type differential, bevel gear pinion and ring gear with spur gear reduction from transmission. All axle components are mounted in tapered roller bearings.

Transmission: Sundstrand in-line hydrostatic transmission is mounted directly to the front axle and driven by flexible drive couplings. Operating pressure is 500 to 3000 psi (3447 to 20685 kPa) and normal charge pressure is 70 to 150 psi (453 to 1034 kPa). Implement relief valve setting is 700 to 800 psi (4826 to 5516 kPa). Displacement is 0.913 cubic inch (15 cm³) per revolution, and transmission is controlled by foot-actuated pedal. Front axle is the hydraulic fluid reservoir, and its capacity is 5 quarts (4.7 L) of SAE 10W-30 or 10W-40 SF engine oil. The 25 micron hydraulic oil filter is a screw on replaceable type. For replacement filters, order Toro part number 23-2300.

Ground Speed: Speed is infinitely variable from 0 to 9.5 mph (0 to 15.3 km/hr) forward and reverse @ 3200 engine rpm.

Tires: Two rear tires are 16 x 6.50-8, 4-ply, rating, rib, on demountable, drop center wheels. The two front tires are 23 x 8.50-12, extra traction tread, 4-ply, rating, on demountable, drop center wheels. Recommended air pressure for both the front and rear tires is 12 psi (83 kPa).

Brakes: Mechanical drum type brakes, 7 in. x 1-3/4 in. (17.7 x 4.5 cm) are mounted on front drive axle. Dynamic braking through propulsion system to the front wheels.

Steering: The 15 inch (38 cm) steering wheel is mounted on steering valve consisting of a control valve and metering section which regulates pressure and controls and meters flow to the steering cylinder. Minimum turning radius is 18 in. (46 cm) from center of turn to closest side of drive wheel; however, zero turning radius results when individual wheel brakes are used.

Main Frame: Frame is welded, formed steel, reinforced with square and rectangular tubing.

Instrumentation: Hour meter, coolant temperature switch/gauge, ammeter and oil pressure light are mounted on the control panel.

Controls: Throttle, choke, and ignition switch are all mounted on control panel. Hand-operated PTO lever is located to the right of the seat. Foot pedal control for transmission operation at right of steering column.

PTO Drive: The 1-1/8 inch (28 mm) diameter, splined PTO shaft is driven from the engine by a tight/slack, double "A" section torque team V-belt. PTO speed is 1810 rpm @ 3200 engine rpm.

Implement Lift: Cutting unit or implement is lifted by hydraulic cylinder that has 2-1/2 in. (64 mm) bore and 3-1/4 in. (82 mm) stroke.

Dimensions and Weights (approx):

<u>Traction Unit</u>	Length:	90 in. (2.29 m)
	Width:	46 in. (1.17 m)
	Height:	50 in. (1.27 m)
	Curb Weight:	1200 lb (499 kg)
<u>Traction Unit with</u>	Length:	111 in. (2.8 m)
<u>Cutting Unit</u>	Width:	85-1/2 in. (2.17 m)
	Height:	50 in. (1.27 m)
	Curb Weight:	1600 lb (725.8 kg)

Optional Equipment:

Leaf Mulcher Kit, Model No. 30732

Standard Seat Kit, Model No. 30785

Deluxe Seat Kit, Model No. 30786

Cutting Unit, Model No. 30721

Cutting Unit, Model No. 30710

Tire Chains, Part No. 11-0390

V-Plow — 48 in. (1.219 m) for snow removal
Model No. 30750

V-Plow Installation Kit, Model No. 30757 (includes
tire chains)

Drive Wheel Weights, Part No. 11-0440

Rear Weights (2 per kit), Part No. 24-5780

23 x 10.5 x 12 Tire and Wheels, Part No. 36-1050

Snowblower, Model No. 30570

Snowblower Kit, Model No. 30571

High Sail Blade, Part No. 23-2410

LOOSE PARTS

Note: Use this chart as a checklist to assure all parts necessary for assembly have been shipped. Without any of these parts, total set-up cannot be completed.

DESCRIPTION	QTY.	USE
Locknut 5/16 - 24 Cotter Pin 3/32 x 1/2 in. (13 mm) Flatwasher 9/32 I.D. x 5/8 in. (16 mm) O.D. Parking Brake Rod Compression Spring Steering Column Cover Self-Tapping Screw Knob	4 3 1 1 1 1 6 1	Install Steering Gear Assembly, page 9.
Steering Wheel Steering Wheel Cap Jam Nut (on steering column)	1 1 1	Install Steering Wheel, page 9.
Ball Joint R.H. (Shipped in tool box)	1	Install Ball Joint (cutting unit installation) and Connect Lift Cylinder, page 12.
Roll Pin 3/16 x 1-1/2 Lift Chain Shackle Shackle Pin 3/8 x 1-1/2 Cotter Pin 1/8 x 3/4 Tension Spring Capscrew 7/16 - 14 x 3 Nut 7/16 - 14 Lockwasher 7/16 Lockwasher 3/8 Capscrew 3/8 - 16 x 1 Flatwasher 7/16 I.D. x 1-1/4 O.D. Flatwasher 7/16 I.D. x 15/16 O.D.	1 3 6 6 6 1 2 2 2 2 3 3 1	Use with cutting units; refer to cutting unit operator's manual for installation instructions.
Wheel Nut 1/2 - 20 Wheel	10 2	Mount Rear Steering Wheels, page 11. Mount On Rear Axle, page 11.
Operator's Manual (Traction Unit) Parts Catalog Engine Parts Catalog Engine Overhaul Manual Engine Operator's Manual Engine Maintenance Schedule Engine Shipment & Delivery Notification	1 1 1 1 1 1 1	
Registration Card	1	Affixed to machine.

SET-UP INSTRUCTIONS

INSTALL STEERING GEAR ASSEMBLY

Tools Required: Pliers, 3/8, 1/2 and 9/16-Inch Sockets

1. Loosen clamp half mounting screws securing steering post to tower (Fig. 1).
2. Slide steering post upward until valve mounting studs are positioned into mounting bracket (Fig. 1).
3. Secure valve to bracket with (4) locknuts (5/16 - 24).
4. Retighten clamp half mounting screws securing steering post to tower.

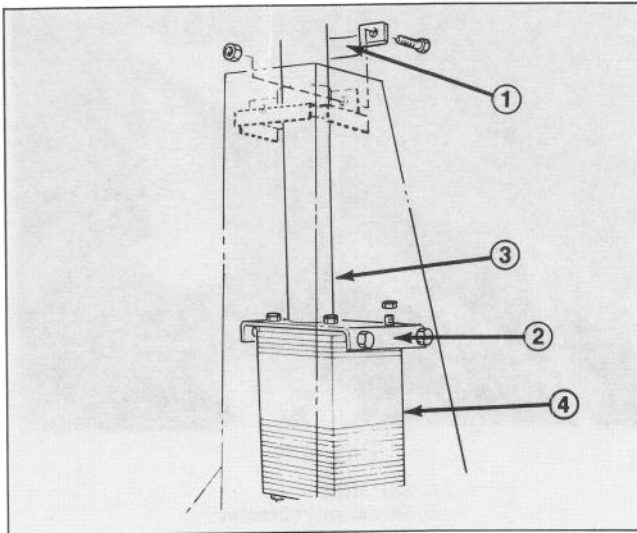

Figure 1

- | | |
|---------------------|------------------|
| 1. Clamp half | 3. Steering post |
| 2. Mounting bracket | 4. Valve |

5. Install cotter pin (3/32 x 1/2 in. - 2.4 x 13 mm) through hole at top of parking brake rod. Install another cotter pin (3/32 x 1/2 in. - 2.4 x 13 mm) through inside hole at L-shaped end of brake rod (Fig. 2). Slide top of rod up the steering tower and bottom of rod between cutout in brake mount and through hole in parking brake latch (Fig. 2). Install remaining cotter pin through end of rod.

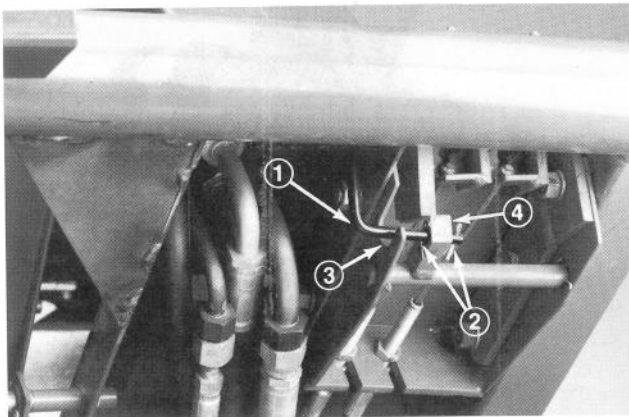

Figure 2

- | | |
|----------------------|-----------|
| 1. Parking brake rod | 3. Cutout |
| 2. Cotter pins | 4. Latch |

6. Slide flat washer (9/32 I.D. x 5/8 in. O.D. - 7.1 x 16 mm) and compression spring onto rod, and assure these parts stay on the rod.

7. Slide steering column cover onto steering post and parking brake rod (Fig. 3). Mount the cover to inside of steering tower with six self tapping screws (1/4 - 20 x 5/8 in.) (Fig. 3). Install the knob on parking brake rod.

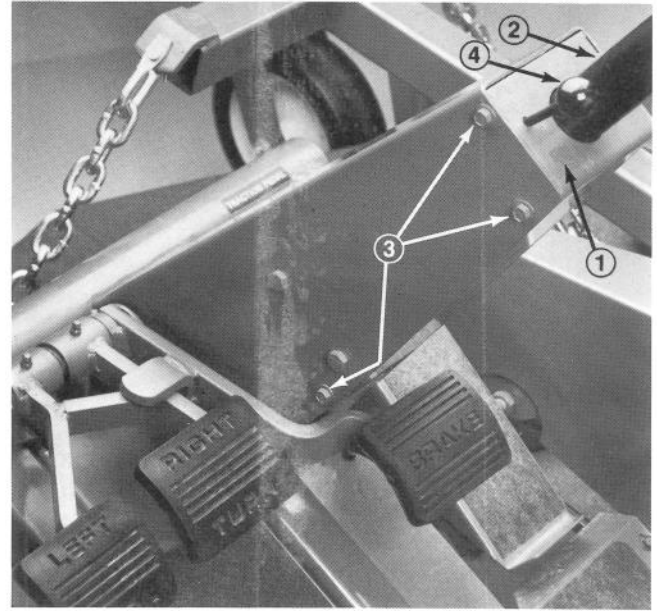

Figure 3

- | | |
|--------------------------|------------------------|
| 1. Steering column cover | 3. Self tapping screws |
| 2. Steering column | 4. Knob |

INSTALL REAR WHEELS

Tools Required: 3/4 inch Socket, Torque Wrench

1. Remove and discard fasteners securing wheels.
2. Mount wheels and torque mounting nuts to 45-55 ft-lb (61-75 N·m).

INSTALL STEERING WHEEL

Tools Required: 15/16-Inch Socket and Torque Wrench

1. Move rear wheels so they point straight ahead.
2. Remove jam nut from steering shaft. Slide steering wheel onto steering shaft and assure small cutout in hub, which accommodates the tab on steering cap, points toward the seat (Fig. 4).
3. Secure steering wheel in place with jam nut (Fig. 4) and tighten it to 70 ft-lb (95 N·m).
4. Insert tab of steering cap into cutout in steering wheel hub (Fig. 4). Press cap into groove in hub.

SET-UP INSTRUCTIONS

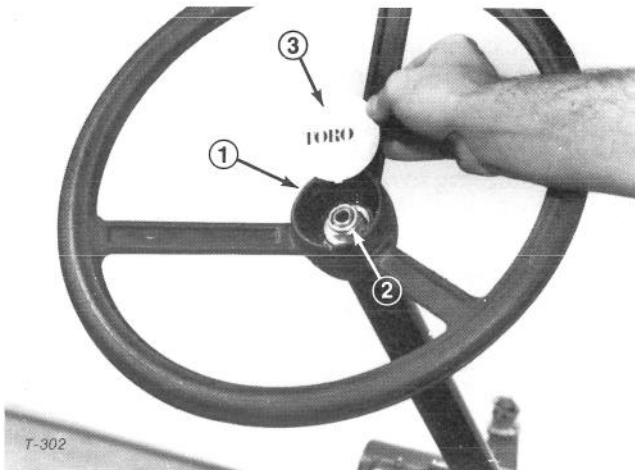

Figure 4

1. Cutout
2. Jam nut
3. Steering wheel cap

REMOVE BATTERY FROM CHASSIS

1. Release two latches holding instrument cover in place. Carefully remove instrument cover to expose battery.
2. Remove two wing nuts and hold down strap that secure battery and seat switch in place (Fig. 5). Lift battery out of Chassis. Keep wing nuts and hold down strap in a safe place for later use.

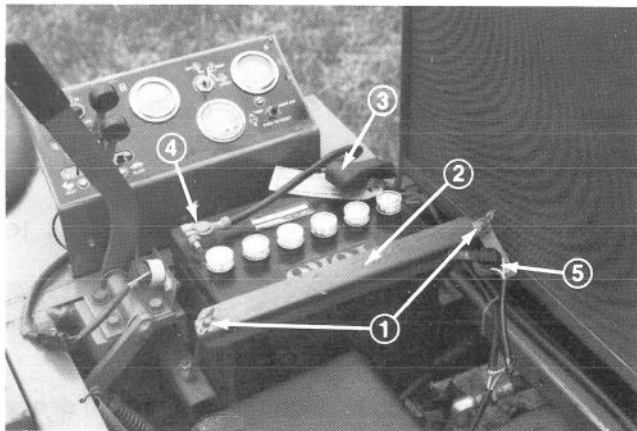

Figure 5

1. Wing nuts
2. Hold down strap
3. Positive terminal
4. Negative terminal
5. Seat switch and shipping bracket

3. Activate and charge battery; refer to Activate And Charge Battery, page 12.

INSTALLING SEAT

The Groundsmaster 327 is shipped without the seat assembly. Either optional Seat Kit, Model No. 30770 or 30786 must be installed.

Seat Kit, Model No. 30770, Standard Seat:

1. Remove seat and hardware from carton.
2. Mount seat support bracket to frame (Fig. 6).

Note: When mounting bracket, slide left capscrew into bracket before lowering into mounting position.

3. Remove seat switch from shipping bracket (Fig. 6) and mount to seat support bracket using same fasteners (Fig. 6). Connect switch connector to main wire harness connector (Fig. 6).

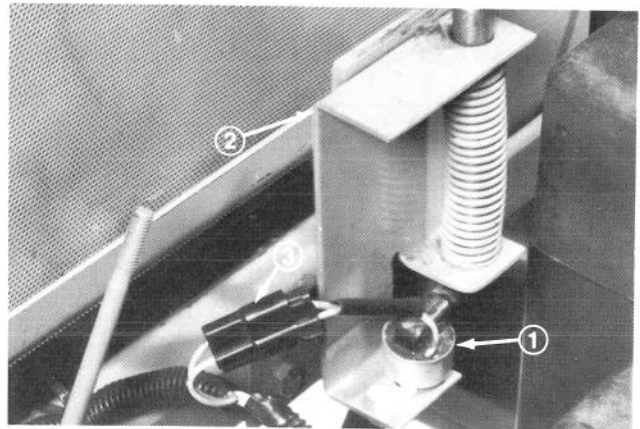

Figure 6

1. Seat switch
2. Seat support bracket
3. Wire connector

4. Install seat support rod to seat support bracket with jam nut (Fig. 9).
5. Slide threaded studs, at front and rear of seat slide channel, through holes in seat support. Secure channels in place with lockwashers and nuts (Fig. 7).

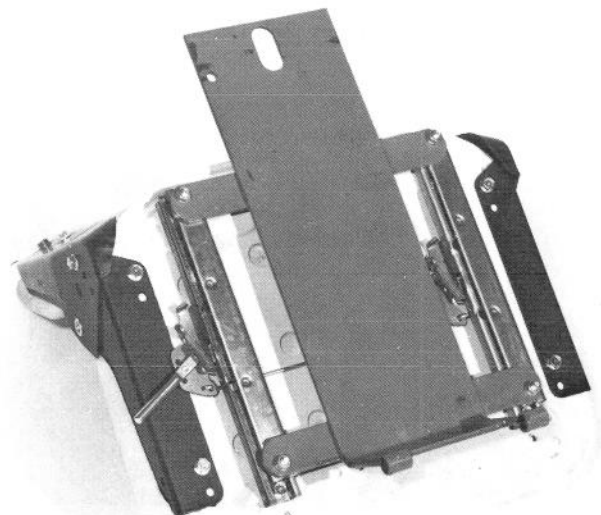

Figure 7

SET-UP INSTRUCTIONS

6. Mount seat and seat support to unit with pivot shaft and roll pin (Fig. 8).

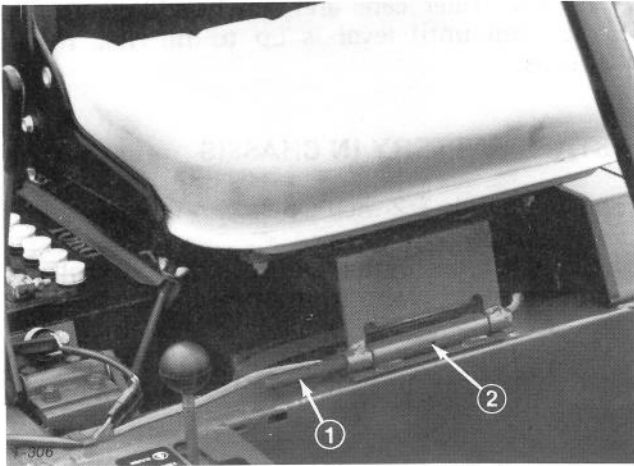

Figure 8

1. Pivot shaft
2. Roll pin

7. Hold seat up with seat support rod.

Seat Kit, Model No. 30786, Deluxe Seat:

1. Remove seat and hardware from carton.
2. Mount seat support bracket to frame (Fig. 6).

Note: When mounting bracket, slide left capscrew in bracket before lowering into mounting position.

3. Remove seat switch from shipping bracket and mount to seat support bracket using same fasteners (Fig. 6).

4. Install seat support rod to seat support bracket with jam nut (Fig. 9).

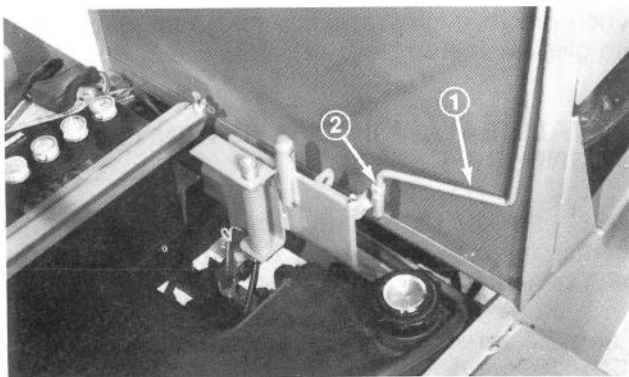

Figure 9

1. Seat support rod
2. Jam nut

5. Unsnap rubber bellows and mount seat suspension to seat support with (4) capscrews, lock-washers and nuts. Resnap bellows in place.

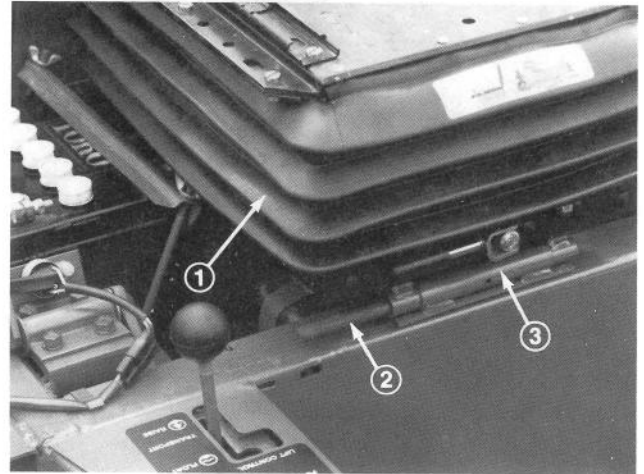

Figure 10

1. Rubber bellows
2. Pivot shaft
3. Roll pin

6. Install seat suspension and seat support to unit with pivot shaft and roll pin (Fig. 10).

7. Slide seat onto track of suspension by releasing track latch.

8. Hold seat up with seat support rod.

PUSH TRACTION UNIT OFF PALLET

Tools Required: None

1. Reach in under seat and rotate by-pass valve (Fig. 11) counterclockwise 1/2 to 1 turn. Opening the valve opens an internal passage in the pump, thereby bypassing transmission oil. Because fluid is by-passed, the machine can be pushed without damaging the transmission.

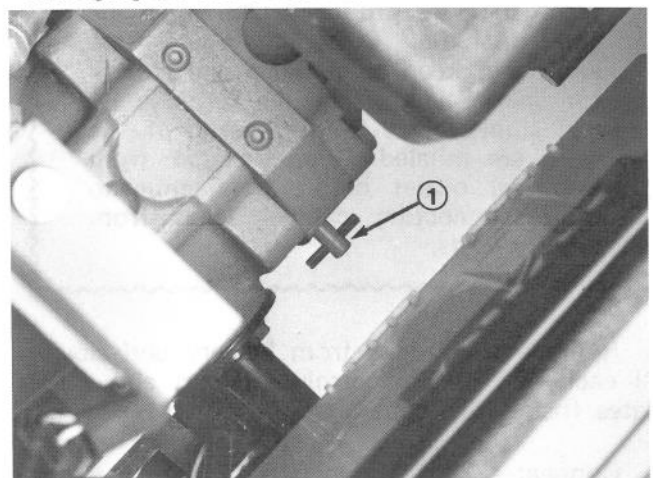

Figure 11

1. By-pass valve

SET-UP INSTRUCTIONS

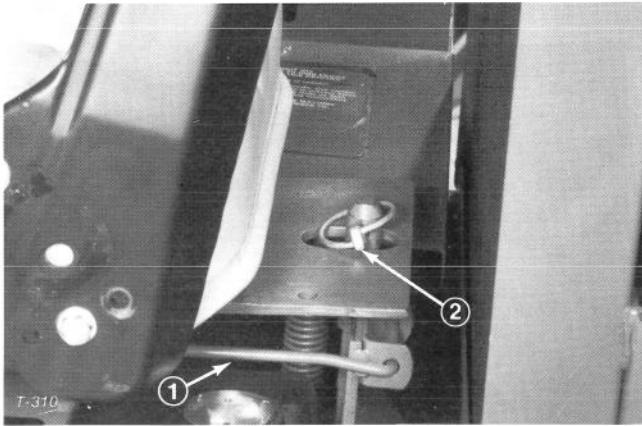

Figure 12

1. Seat support rod
2. Lynch pin

2. Slowly push machine off pallet.
3. Close by-pass valve by rotating it clockwise until it is securely seated. Do not exceed 5 to 8 ft-lb (7 to 11 N·m). Do not start engine when valve is open.

ACTIVATE AND CHARGE BATTERY

Tools Required: 3 to 4 Amp Battery Charger

1. Since battery is not filled with electrolyte or charged, bulk electrolyte with 1.260 specific gravity must be purchased from a local battery supply outlet.



CAUTION

Wear safety goggles and rubber gloves when working with electrolyte, and charge the battery in a well-ventilated place so gases produced while charging can dissipate. Since the gases are explosive, keep open flame and electrical spark away from the battery; do not smoke. Nausea may result if the gases are inhaled. Unplug charger from electrical outlet before connecting to or disconnecting charger leads from battery posts.

2. Remove filler caps from battery and slowly fill each cell until electrolyte is just above the plates. Install filler caps.
3. Connect a 3 to 4 amp battery charger to the battery posts. Charge the battery at a rate of 3 to 4 amperes for 4 to 8 hours.

4. When battery is fully charged, disconnect charger from electrical outlet and battery posts.
5. Remove filler caps and slowly add electrolyte to each cell until level is up to fill ring. Install filler caps.

INSTALL BATTERY IN CHASSIS

Tools Required: 1/2-Inch Open End Wrench

1. Set charged battery onto battery shelf so negative post is toward front of machine.
2. Push battery against frame near instrument panel so battery does not contact any hydraulic lines.
3. Secure battery in place with hold down strap and wing nuts (Fig. 5). Tighten wing nuts securely to prevent battery from moving while machine is operated.
4. Slide the red, positive battery cable (Fig. 5) onto positive battery post and tighten nut securely.
5. Slide the black, negative battery cable (Fig. 5) onto negative battery post and tighten nut securely.
6. Coat both battery connections with either Grafo 112X (skin-over) grease, Toro Part No. 505-47, petroleum jelly or light grease to prevent corrosion and slide rubber boot over positive terminal (Fig. 5).
7. Install the instrument cover and lock the two latches.
8. Disengage seat support rod and slide it into retaining clips (Fig. 12). Pivot seat down and push lynch pin through seat latch stud. Flip wire end of pin over latch stud (Fig. 12).

INSTALL BALL JOINTS AND CONNECT LIFT CYLINDER

Note: Ball Joints are not required for all implements; refer to implement operator's manual for requirements.

Tools Required: Pliers, Tape Measure and 2 x 4 in. (51 x 102 mm) Block of Wood

1. Thread jam nut fully onto right hand ball joint.
2. Screw ball joint into right hand push arm until center of ball joint is 2-3/8 inches (60 mm) away from front of push arm (Fig. 13). Do not tighten jam nut.

SET-UP INSTRUCTIONS

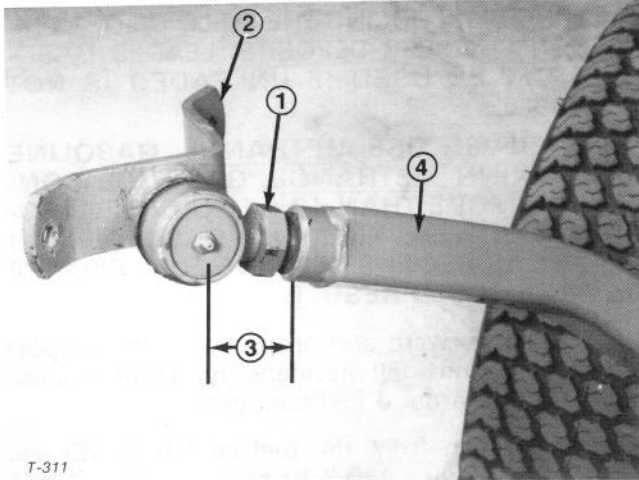

Figure 13

1. Jam nut
2. Ball joint mount
3. 2-3/8 in. (60 mm)
4. Right hand push arm



WARNING

Since left hand push arm is spring-loaded to about 150 pounds (68 kg), a helper is required to push the arm down during installation of the ball joint. Sudden release of the push arm could cause injury.

4. Have a helper push down on the left push arm; then insert a 2 x 4 in. (51 x 102 mm) block of wood between the frame and top of the push arm (Fig. 14). Screw ball joint into left hand push arm

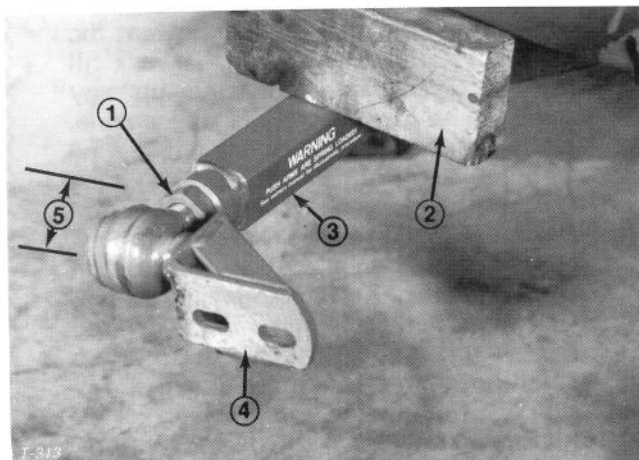

Figure 14

1. Jam nut
2. 2 x 4 in. (51 x 102 mm) block
3. Left hand push arm
4. Ball joint mount
5. 2-3/8 in. (60 mm)

until center of ball joint is 2-3/8 inches (60 mm) away from front of push arm (Fig. 14). Do not tighten jam nut.

5. Carefully remove 2 x 4 in. (51 x 102 mm) block of wood from between frame and push arm.

6. Remove spring pin from cylinder pin and slide cylinder pin out of cylinder.

7. Raise front of lift arm until hole in moveable end of cylinder lines up with holes in lift arm brackets. Use caution as lift arm is spring loaded. Hold parts together with cylinder pin, spring pin and cotter pin. Cotter pin must be to the outside (page 46, Fig. 65).

8. Install implement; refer to implement Operator's Manual for proper installation procedures.

CHECK TIRE PRESSURE

Tools Required: Low Pressure Tire Gauge

The tires are over-inflated for shipping. Therefore, release some of the air to reduce the pressure. Correct air pressure in the front and rear tires is 12 psi (83 kPa).

CHECK TORQUE OF FRONT WHEEL NUTS



WARNING

Tighten front wheel nuts to 45-55 ft-lb (61-75 N·m) after 1-4 hours of operation and again after 10 hours of operation and every 250 hours thereafter. Failure to maintain proper torque could result in failure or loss of wheel and may result in personal injury.

GREASE TRACTION UNIT

Tools Required: No. 2 General Purpose Lithium Grease and Grease Gun

Before the machine is operated, it must be greased to assure proper operating characteristics; refer to Lubrication, page 20. Failure to grease the machine will result in premature failure of critical parts.

BEFORE OPERATING

CHECK CRANKCASE OIL

The engine is shipped with 3 quarts (2.84 L) of oil in the crankcase; however, level of oil must be checked before and after the engine is first started.

1. Position machine on a level surface.
2. Disengage hood latch and open the hood.
3. Remove dipstick and wipe it with a clean rag. Push dipstick down into the tube and ensure it is seated fully. Pull dipstick out of the tube and check level of oil. If oil level is low, remove filler cap (Fig. 15) and add enough oil to raise level to top of flat at end of dipstick. **DO NOT OVERFILL.**

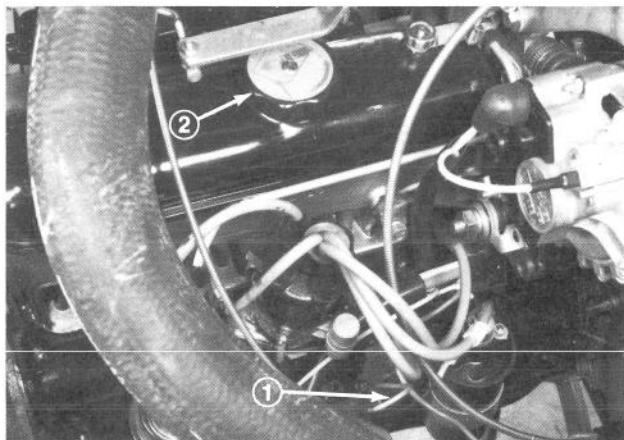

Figure 15

1. Oil dipstick 2. Filler cap

4. The engine uses any high-quality detergent oil having the American Petroleum Institute – API – “service classification” SF Oil viscosity – weight – must be selected according to anticipated ambient temperature. Temperature/viscosity recommendations are:

- A. Above 0° F (-18° C) – Use Sae 10W-30 or 10W-40.
- B. Below 0° F (-18° C) – Use SAE 5W-20 or 5W-30.

IMPORTANT: Check level of oil after every 5 hours of operation or daily; thereafter, change oil after every 50 hours of operation. Change oil and filter more frequently when engine is operated in extremely dusty or dirty conditions.

5. Install dipstick into tube.

FILL FUEL TANK WITH GASOLINE

THE TORO COMPANY STRONGLY RECOMMENDS THE USE OF CLEAN, FRESH **UNLEADED** REGULAR GASOLINE IN TORO GASOLINE POWERED PRODUCTS. UNLEADED GASOLINE BURNS CLEANER, EXTENDS ENGINE LIFE, AND PROMOTES GOOD

STARTING BY REDUCING THE BUILD-UP OF COMBUSTION CHAMBER DEPOSITS. LEADED GASOLINE CAN BE USED IF UNLEADED IS NOT AVAILABLE.

NOTE: NEVER USE METHANOL, GASOLINE CONTAINING METHANOL, GASOLINE CONTAINING MORE THAN 10% ETHANOL, GASOLINE ADDITIVES, PREMIUM GASOLINE, OR WHITE GAS BECAUSE ENGINE FUEL SYSTEM DAMAGE COULD RESULT.

1. Tip seat forward and prop it with the support rod so it cannot fall accidentally. Using a clean rag, clean area around fuel tank cap.
2. Remove cap from the fuel tank (Fig. 16) and fill the 8-1/2 gallon (30.3 L) tank to within 1 inch (25 mm) from the top with gasoline. Install fuel tank cap tightly after filling tank.

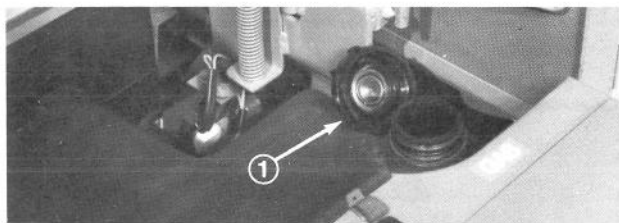

Figure 16

1. Non-vented fuel cap



DANGER

Because gasoline is flammable, caution must be used when storing or handling it. Do not fill fuel tank while engine is running, hot or when machine is in an enclosed area. Vapors may build up and be ignited by a spark or flame source many feet away. **DO NOT SMOKE** while filling the fuel tank to prevent the possibility of an explosion. Always fill fuel tank outside and wipe up any spilled gasoline before starting engine. Use a funnel or spout to prevent spilling gasoline, and fill tank to about 1 inch (25 mm) below the filler neck. Store gasoline in a clean safety-approved container and keep the cap in place on the container. Keep gasoline in a cool, well-ventilated place; never in an enclosed area such as a hot storage shed. To assure volatility, do not buy more than a 30 day supply of gasoline. Gasoline is a fuel for internal combustion engines; therefore, do not use it for any other purpose. Since many children like the smell of gas, keep it out of their reach because the fumes are explosive and dangerous to inhale.

BEFORE OPERATING

CHECK COOLING SYSTEM

Clean debris off screen and front of radiator daily, hourly if conditions are extremely dusty and dirty; refer to Cleaning Radiator and Screen, page 29.

The cooling system is filled with a 50/50 solution of water and permanent ethylene glycol anti-freeze. Check level of coolant at beginning of each day, before starting the engine. Capacity of cooling system is approximately 6 quarts (5.7 L).

The Toro Company strongly recommends the **use of an anti-freeze designed specifically for aluminum engines.**

1. **⚠** Carefully remove radiator cap. Coolant is pressurized and may be hot if engine has been running.
2. Check level of coolant in radiator. Level of coolant must be above the core and about 1 inch (25 mm) below bottom of filler neck.
3. If coolant level is low, replenish the system. **DO NOT OVERFILL.**
4. Install radiator cap.

CHECK HYDRAULIC SYSTEM OIL

The hydraulic system is designed to operate on any high-quality detergent oil having the American Petroleum Institute — API — "service classification" SF. Oil viscosity — weight — must be selected according to anticipated ambient temperature. Temperature/viscosity recommendations are:

- A. Above 32°F (0°C) — Use SAE 10W-40 or 10W-30 engine oil.
- B. Below 32°F (0°C) — SAE 5W-20 or 5W-30 engine oil. Or Type A Automatic Transmission fluid.

Note: Do not mix engine oil and automatic transmission fluid or hydraulic system component damage may result. When Changing fluids also change transmission filter. **DO NOT USE DEXTRON II ATF.**

Note: The Power Steering is supplied by the hydraulic system. Cold weather start-up may result in "stiff" operation of the steering, until the hydraulic system has warmed up.

Using proper weight hydraulic oil in system will minimize this condition.

The axle housing acts as the reservoir for the system. The transmission and axle housing are shipped from the factory with approximately 5 quarts (4.7 L) of oil. However, check level of transmission oil before engine is first started and daily thereafter.

1. Position machine on a level surface, raise the implement and stop the engine.
2. Unscrew dipstick cap (Fig. 17) from filler neck and wipe it with a clean rag. Screw dipstick cap finger-tight onto filler neck. Unscrew the dipstick and check level of oil. If level is not within 1/2 inch (13 mm) from the groove in the dipstick (Fig. 17), add enough oil to raise level to groove mark. **DO NOT OVERFILL** by more than 1/2 inch (13 mm) above groove.

IMPORTANT: When adding oil to the hydraulic system, use funnel with a fine wire screen — 200 mesh — and insure funnel and oil are immaculately clean. This procedure prevents accidental contamination of the hydraulic system.

3. Screw dipstick filler cap finger-tight onto filler neck. It is not necessary to tighten cap with a wrench.
4. Lower the implement.

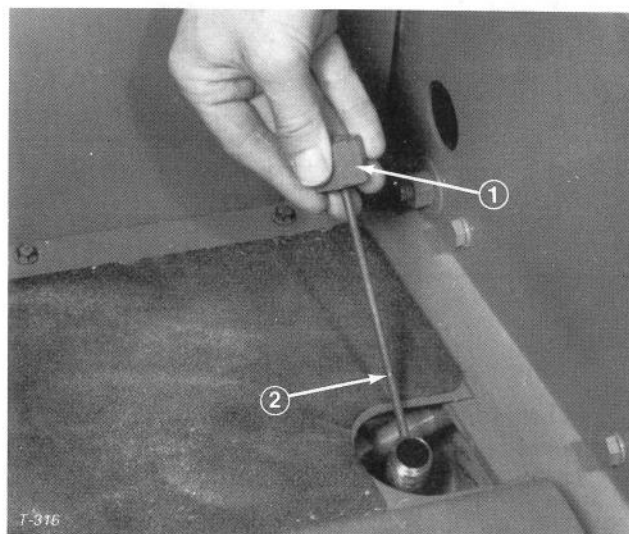

Figure 17

1. Dipstick cap
2. Groove

CONTROLS

Traction Pedal (Fig. 18) — Traction pedal has two functions; one is to make the machine move forward, the other is to make it move backward. Using the heel and toe of the right foot, depress top of pedal to move forward and bottom of pedal to move backward. Ground speed is proportionate to how far pedal is depressed. For maximum ground speed with no load, traction pedal must be fully depressed while throttle is in FAST position. Maximum speed forward is approximately 9.5 mph (15.3 km/hr). To get maximum power under heavy load or when ascending a hill, have throttle in FAST position while depressing traction pedal slightly to keep engine rpm high. When engine rpm begins to decrease, release traction pedal slightly to allow engine rpm to increase.

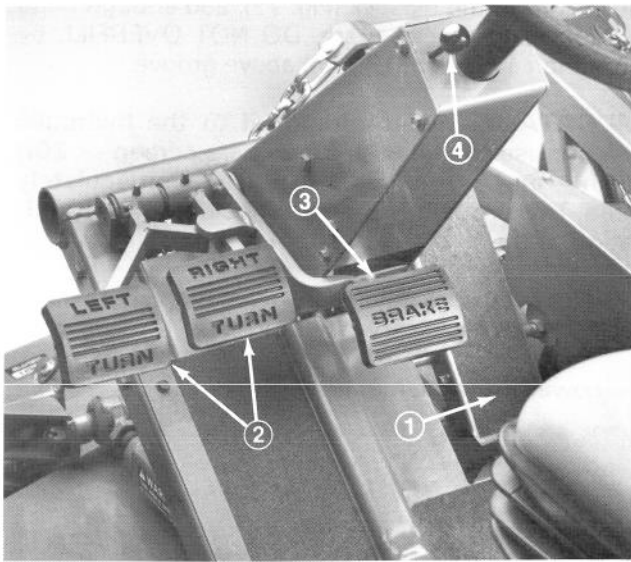

Figure 18

- 1. Traction pedal
- 2. Turn pedals
- 3. Brake pedal
- 4. Parking brake knob



CAUTION

When foot is removed from the traction pedal, machine should stop; it must not creep in either direction. If machine does creep, do not operate until neutral assembly has been repaired and adjusted; refer to Adjusting Traction Drive For Neutral, page 32.

Brake Pedal (Fig. 18) — Whenever the engine is shut off, the parking brake must be engaged to prevent accidental movement of the machine.

⚠ The hydrostatic transmission will not, at any time, act as a parking brake for the machine. To engage parking brake, push down fully on brake pedal and pull parking brake knob out; then release the pedal. To release parking brake, depress brake pedal until parking brake knob retracts. To stop quickly, remove right foot from traction pedal and depress the brake pedal. To permit straight stops, brake cables must be evenly adjusted.

Lift Lever (Fig 19) — The hydraulic lift lever has three positions; FLOAT, TRANSPORT and RAISE. To lower implement to the ground, move lift lever forward into notch, which is the FLOAT position. The FLOAT position is used for operation and also when machine is not in operation. To raise implement, pull lift lever backward to the RAISE position. After implement is raised, allow lift lever to move to the TRANSPORT position. Normally, implement should be raised when driving from one work area to another, except when descending steep slopes.

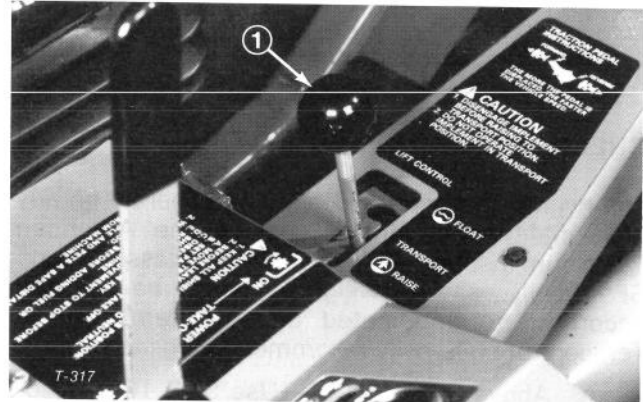

Figure 19

- 1. Lift lever



CAUTION

Never raise implement or cutting unit while blades or other components are rotating. The exposed, rotating blades are hazardous.

Turn Pedals (Fig. 18) — The left and right turn pedals are connected to the left and right front wheel brakes. Since both brakes work independently of each other, the brakes can be used to turn sharply or to increase traction if one wheel tends to slip while operating on a hillside. However, wet grass or soft turf could be damaged when brakes are used to turn.

PTO Lever (Fig. 20) — The PTO lever has two positions; ON, engage and OFF, disengage. Slowly push PTO lever fully forward to ON position to start the implement or cutting unit blades. Slowly, pull lever backward to OFF position to stop implement operation. The only time PTO lever should be in the ON position is when implement or cutting unit is down in operating position.

CONTROLS

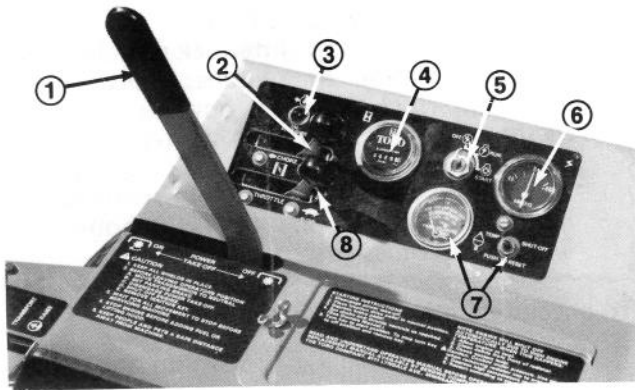

Figure 20

- | | |
|---------------------------|-------------------------|
| 1. PTO lever | 5. Ignition switch |
| 2. Choke | 6. Ammeter |
| 3. Oil pressure indicator | 7. Temp gauge and reset |
| 4. Hour meter | 8. Throttle control |

Oil Pressure Warning Light (Fig. 20) — The oil pressure warning light will glow and a buzzer will sound when oil pressure in engine drops below a safe level. If low oil pressure ever occurs, stop engine and determine the cause. Repair the damage before starting the engine again.

Hour Meter (Fig. 20) — The hour meter registers accumulated hours of engine operation. Use the hour meter to determine intervals for service maintenance and lubrication.

Ammeter (Fig. 20) — Ammeter shows charge rate of the battery by the alternator. When engine is running, there usually is a slight charge, unless engine is idling slowly. Needle will point to 0 when battery is fully charged. By contrast, alternator is not charging the battery when needle points to (-) negative side of ammeter, and if this happens, repair the charging system to prevent discharge of the battery.

Temperature Switch/Gauge and Reset Button (Fig. 20) — The temperature switch/gauge registers the temperature of the coolant in the cooling system. If temperature of coolant gets too high the engine will shut off automatically. When this happens, rotate ignition key to OFF. Automatic shut-off of the engine usually results from debris on front of screen or radiator, which reduces air flow. After cleaning outside of screen and radiator or repairing some other damage, press the reset button and start the engine.

IMPORTANT: If the switch ever must be overridden because of an emergency, the engine can be started and will continue to run while reset button is held in.

Ignition Switch (Fig. 20) — The ignition switch, which is used to start and stop the engine, has three positions; OFF, RUN and START. Rotate

key clockwise to the START position to engage starter motor. When engine starts, release key and it will move automatically to the ON position. To shut engine off, rotate key counterclockwise to the OFF position.

Choke (Fig. 20) — To start a cold engine, close carburetor choke by moving choke control fully forward. After engine starts, regulate choke to keep engine running smoothly. As soon as possible, open the choke by pulling it backward.

Throttle (Fig. 20) — Throttle is used to operate engine at various speeds. Moving throttle forward increases engine speed — FAST; backward decreases engine speed — SLOW. The throttle regulates the speed of the cutter blades or other implement components and, in conjunction with traction pedal, controls ground speed of the traction unit.

Electrical System Fuses (Fig. 21) — An engine temperature reset relay fuse — SFE 14 amp — is located at the rear of the reset relay. An inline fuse — AGC 15 amp — is also incorporated for the interlock switch system. Access to the fuses can be gained by removing the instrument panel cover.

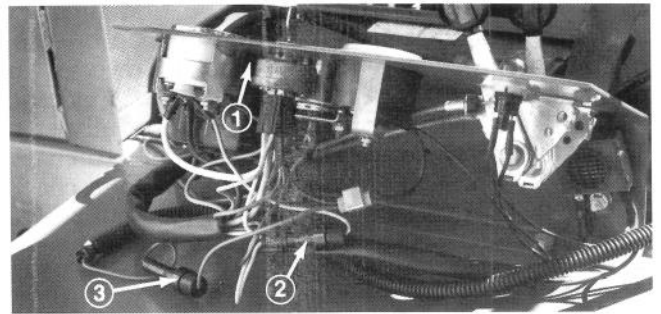

Figure 21

1. SFE 14 amp fuse — engine temperature reset relay
2. Inline AGC 15 amp fuse — interlock switch system
3. Inline 3AG fuse — 3 amp — cruise control (optional)

Seat Adjusting Levers (Fig. 22) — To adjust standard seat, push lever backward and slide seat to the desired position. Release lever to lock seat in place.

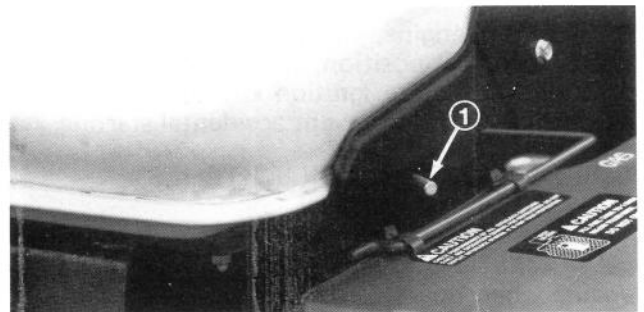

Figure 22

1. Seat adjusting lever

The suspension seat may be adjusted forward or rearward by pulling out the lever at the right side of the seat, sliding the seat to the desired position, and releasing the lever. The weight adjustment knob may be adjusted for any operator's comfort.

OPERATING INSTRUCTIONS

STARTING/STOPPING ENGINE

1. Insure parking brake is set, PTO lever is in OFF position (Fig. 20) and lift lever is in TRANSPORT or FLOAT position (Fig. 19). Remove foot from traction pedal and assure it is in neutral.
2. Move throttle control (Fig. 20) to SLOW position.
3. To start engine, move choke lever (Fig. 20) fully forward.
4. Insert key into ignition switch (Fig. 20) and rotate it clockwise to START position. Release key immediately when engine starts and regulate choke to keep engine running smoothly.

IMPORTANT: To prevent overheating of the starter motor, do not engage starter longer than 15 seconds. After 15 seconds of continuous cranking, wait 10 to 15 seconds before engaging starter motor again. To prevent a short in the ignition system, use only one key in the switch. If keys are on a ring, one of the keys could contact pin on top of temperature gauge resulting in a short.

5. When engine is started for the first time, or after overhaul of the engine, transmission or axle, operate the machine in forward and reverse for one to two minutes. Also operate the lift lever and PTO lever to ensure proper operation of all parts. Turn steering wheel to the left and right to check steering response. Then shut engine off and check for oil leaks, loose parts and any other noticeable defects.



CAUTION

Shut engine off and wait for all moving parts to stop before checking for oil leaks, loose parts and other defects.

6. To stop engine, move throttle control backward to SLOW position, move PTO lever to OFF position and rotate ignition key to OFF. Remove key from switch to prevent accidental starting.

CHECKING INTERLOCK SWITCHES

The machine has interlock switches in the electrical system. These switches are designed to stop the engine when operator gets off the seat while either the PTO lever is engaged or traction pedal is depressed. However, operator may get off the seat while engine is running. Although engine will continue to run if PTO lever is disengaged and traction pedal is released, it is strongly recommended that the engine be stopped before dismounting from the seat.



CAUTION

Do not disconnect the interlock switches. Check operation of switches daily to assure interlock system is operating correctly. If a switch is defective, replace it before operating the machine. To ensure maximum safety, replace all switches after every two years or 1000 hours, whichever comes first.

To check operation of interlock switches:

1. Move PTO lever to OFF position and remove foot from traction pedal so it is fully released.
2. Try to start the engine. If engine starts, proceed to step 3. If engine does not crank there may be a defect in the electrical system; refer to Electrical Troubleshooting, pages 22-26.
3. Raise off the seat and move PTO lever to ON position while the engine is running. The engine should stop. If engine stops, the PTO switch is operating correctly; thus, proceed to step 4. If engine does not stop there is a defect in the safety interlock system; refer to Electrical Troubleshooting, pages 22-26.



WARNING

Do not operate machine without implement unless the PTO driveshaft is also removed.

4. Move PTO lever to OFF position. Raise off the seat and depress traction pedal slowly while engine is running. The engine should stop. If engine stops, the neutral switch is operating correctly. If engine does not stop, there is a defect in the electrical system; refer to Electrical Troubleshooting, pages 22-26.
5. If all the switches operated correctly, the machine can be operated.

PUSHING OR TOWING TRACTION UNIT

In an emergency, the traction unit can be pushed or towed for a very short distance. However, Toro does not recommend this as standard procedure.

IMPORTANT: Do not push or tow the traction unit faster than 2 to 3 mph (3 to 4.8 km/hr) because transmission may be damaged. If traction unit must be moved a considerable distance, transport it on a truck or trailer. Whenever traction unit is pushed or towed, by-pass valve must be open.

OPERATING INSTRUCTIONS

1. Reach under traction unit and rotate by-pass valve (Fig. 23) 1/2 to 1 turn counterclockwise. Opening the valve opens an internal passage in the transmission, thereby by-passing transmission oil. Because fluid is by-passed, traction unit can be moved without damaging the transmission.

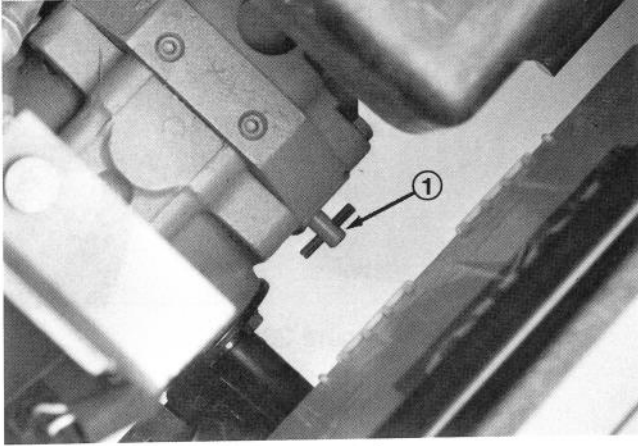

Figure 23
1. By-pass valve

2. Before starting engine, close by-pass valve by rotating it clockwise until it is securely seated. Do not exceed 5 to 8 ft-lb (7-11 N·m). Do not start engine when valve is open.

IMPORTANT: Running the machine with by-pass valve open will cause the transmission to overheat.

OPERATING CHARACTERISTICS

Practice driving the GROUNDMASTER 327 because it has a hydrostatic transmission and its characteristics are different than many turf mainten-

ance machines. Some points to consider when operating the traction unit, cutting unit or other implement are the transmission, engine speed, load on the cutting blades or other implement components, and the importance of the brakes.

To maintain enough power for the traction unit and implement while operating, regulate traction pedal to keep engine rpm high and somewhat constant. A good rule to follow is; decrease ground speed as the load on the implement increases; and increase ground speed as the load decreases. Therefore, allow traction pedal to move backward as engine rpm decrease, and depress pedal slowly as rpm increase. By comparison, when driving from one work area to another — with no load and cutting unit raised — have throttle in FAST position and depress traction pedal slowly but fully to attain maximum ground speed.

Another characteristic to consider is the operation of the turning pedals that are connected to the brakes. The brakes can be used to assist in turning the machine; however, use them carefully, especially on soft or wet grass because the turf may be torn accidentally. Another benefit of the turning brakes is to maintain traction. For example: in some slope conditions, the uphill wheel slips and loses traction. If this situation occurs, depress uphill turn pedal gradually and intermittently until the uphill wheel stops slipping; thus, increasing traction on the downhill wheel.

Before stopping the engine, disengage all controls and move throttle to SLOW. Moving throttle to SLOW reduces high engine rpm, noise, vibration and the possibility of backfiring by the engine. Turn key to OFF to stop engine.

LUBRICATION MAINTENANCE

GREASING BEARINGS, BUSHINGS, GEAR BOX AND BRAKE CABLES

Tools Required: Clean Rag, and Grease Gun w/No. 2 General Purpose Lithium Grease

The traction unit must be lubricated regularly. If machine is operated under normal conditions, lubricate all bearings and bushings after every 50 hours of operation.

1. The traction unit bearings and bushings that must be lubricated are: PTO shaft and yokes (Fig. 24); lift arm pivots (Fig. 25); right and left push arm ball joints (Fig. 24); push arm pivot bushings (Fig. 26); PTO pivot housing blocks (Fig. 27); brake pivot bushings (Fig. 28); rear wheel spindle bushings (Fig. 29); steering plate bushings (Fig. 29); axle pin bushing (Fig. 29); and engine output shaft bearing (Fig. 30). Also apply grease to both brake cables at the drive wheel and brake pedal ends.

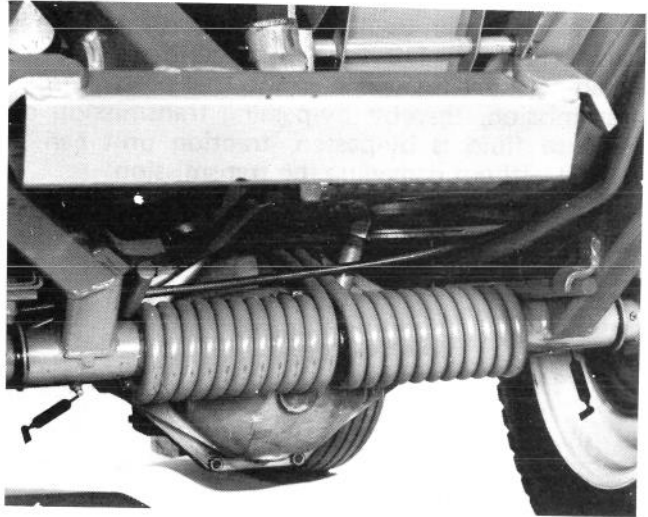

Figure 26

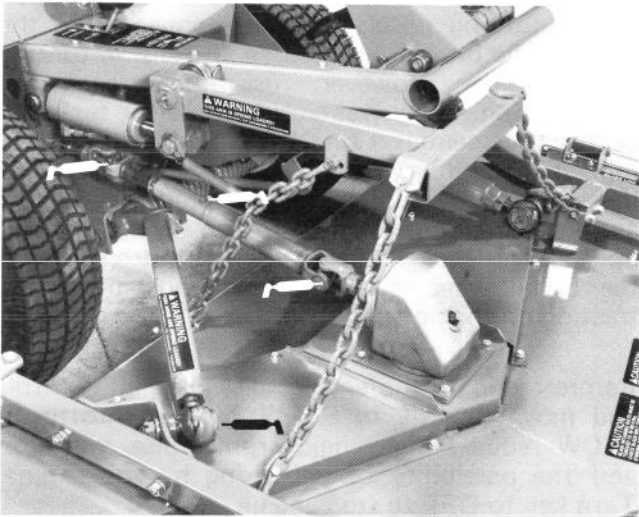

Figure 24

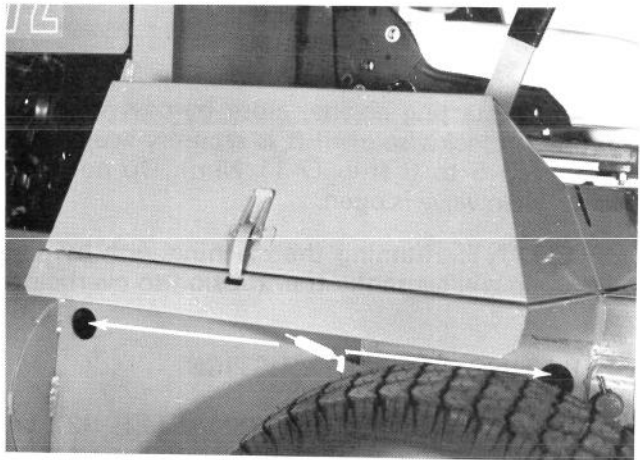

Figure 27

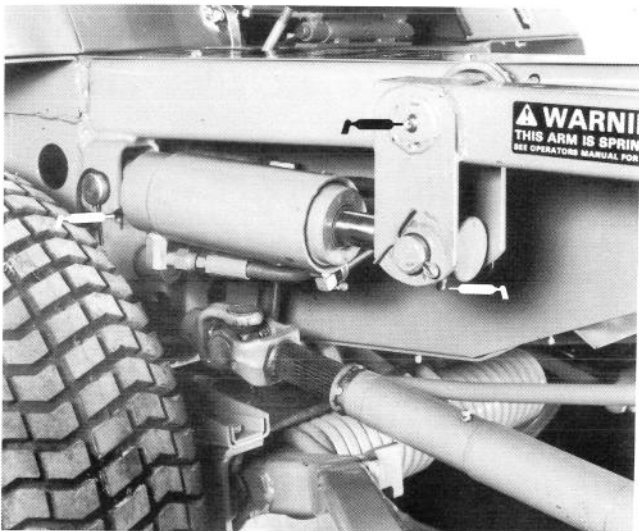

Figure 25

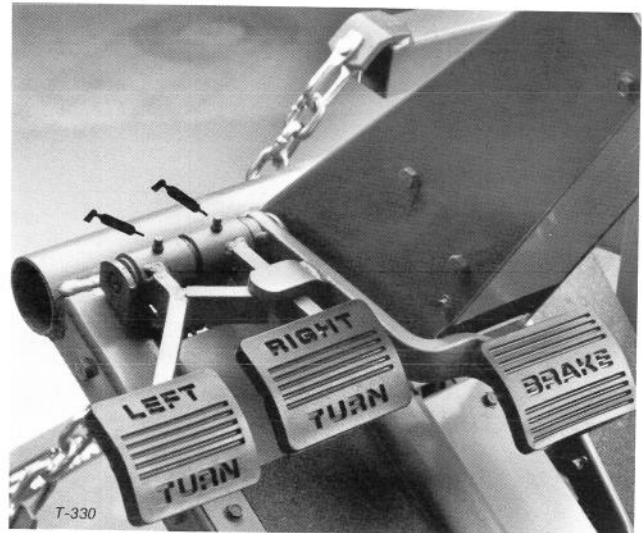

Figure 28

LUBRICATION MAINTENANCE

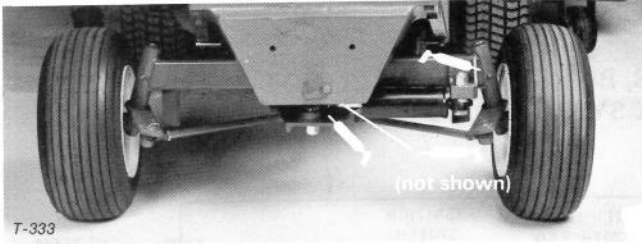

Figure 29

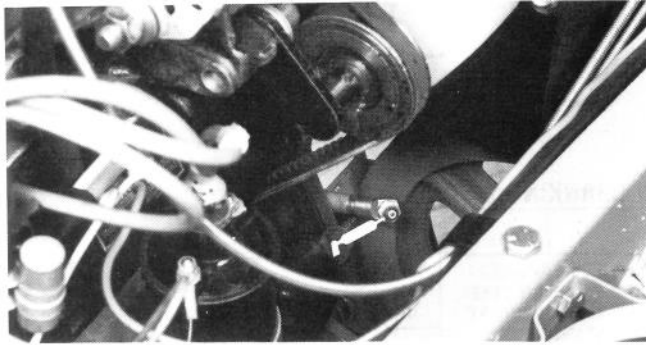

Figure 30

REPLACING/PACKING REAR WHEEL BEARINGS

Pack the rear wheel bearings with Molybdenum E.P. or No. 2 general purpose lithium grease, after every 500 hours of operation or once a year. If operating conditions are extremely dusty and dirty, it may be necessary to pack the bearings more often.

1. Jack up rear of machine until tire is off shop floor. Support machine with jack stand to prevent it from falling.

2. Remove dust cap from rear wheel. Then remove cotter pin, slotted nut and washer, and slide wheel off spindle shaft. Pull seal out of inboard side of wheel hub.

3. Remove bearings from wheel hub (Fig. 31). Clean the bearings in solvent and assure they are in good operating condition. Also, clean the inside of the wheel hub.

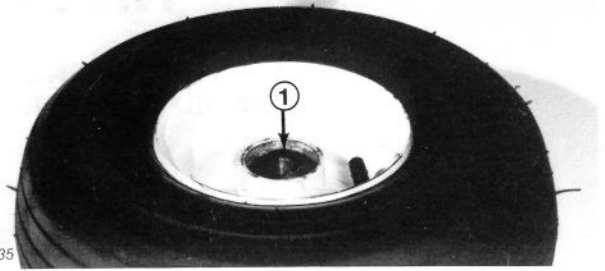

Figure 31

1. Bearing

4. Check the bearing cups (Fig. 32) for wear, pitting or other noticeable damage. Replace defective parts. If bearing cups were removed from the wheel hub, press them into the hub until they seat against the shoulder.

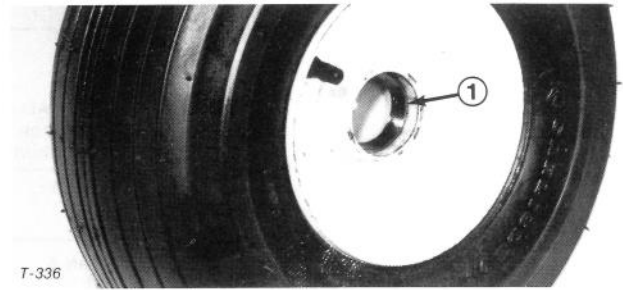

Figure 32

1. Bearing cup

5. Pack both bearings with grease. Install bearing into cup on inboard side of wheel hub. Lubricate inside of new lip seal and press it into the wheel hub.

Note: Lip seal must be pressed in so it is flush with end of hub, and the lip must face toward the bearing.

6. Pack inside of wheel hub with some grease, but not full. Install remaining bearing into the bearing cup.

7. Slide wheel assembly onto spindle shaft and secure it in place with flatwasher and slotted nut. Do not tighten the nut and do not install the cotter pin because bearing preload must be adjusted.

8. Adjust preload on the wheel bearings; refer to Adjusting Rear Wheel Bearings, steps 3-5, page 36.

ELECTRICAL MAINTENANCE TROUBLESHOOTING

**PROBLEM: STARTER SOLENOID CLICKS, BUT STARTER WILL NOT CRANK.
(IF SOLENOID CLICKS INTERLOCK SYSTEM IS NOT AT FAULT)**

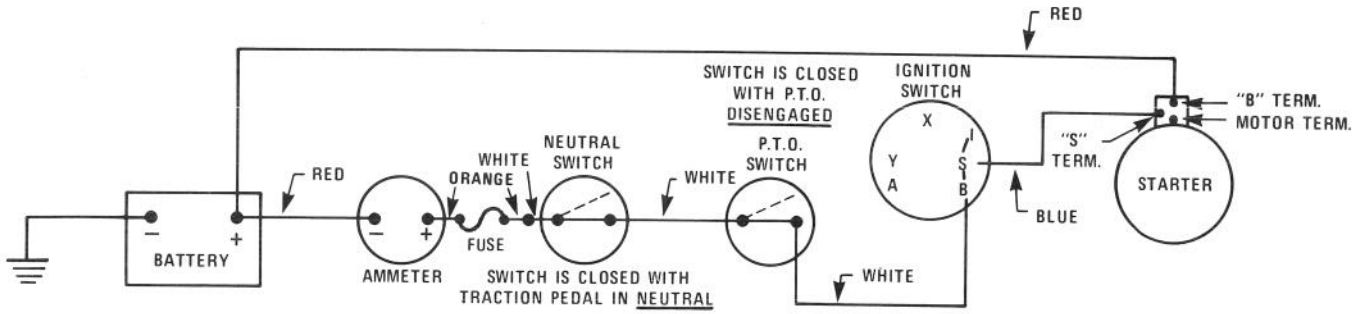

CIRCUIT INVOLVED WITH CRANKING ENGINE

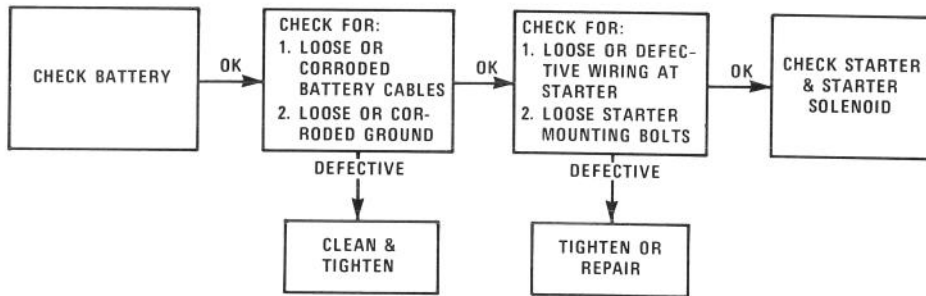

**PROBLEM: NOTHING HAPPENS WHEN START ATTEMPT IS MADE.
REFER TO CIRCUIT DIAGRAM ABOVE.**

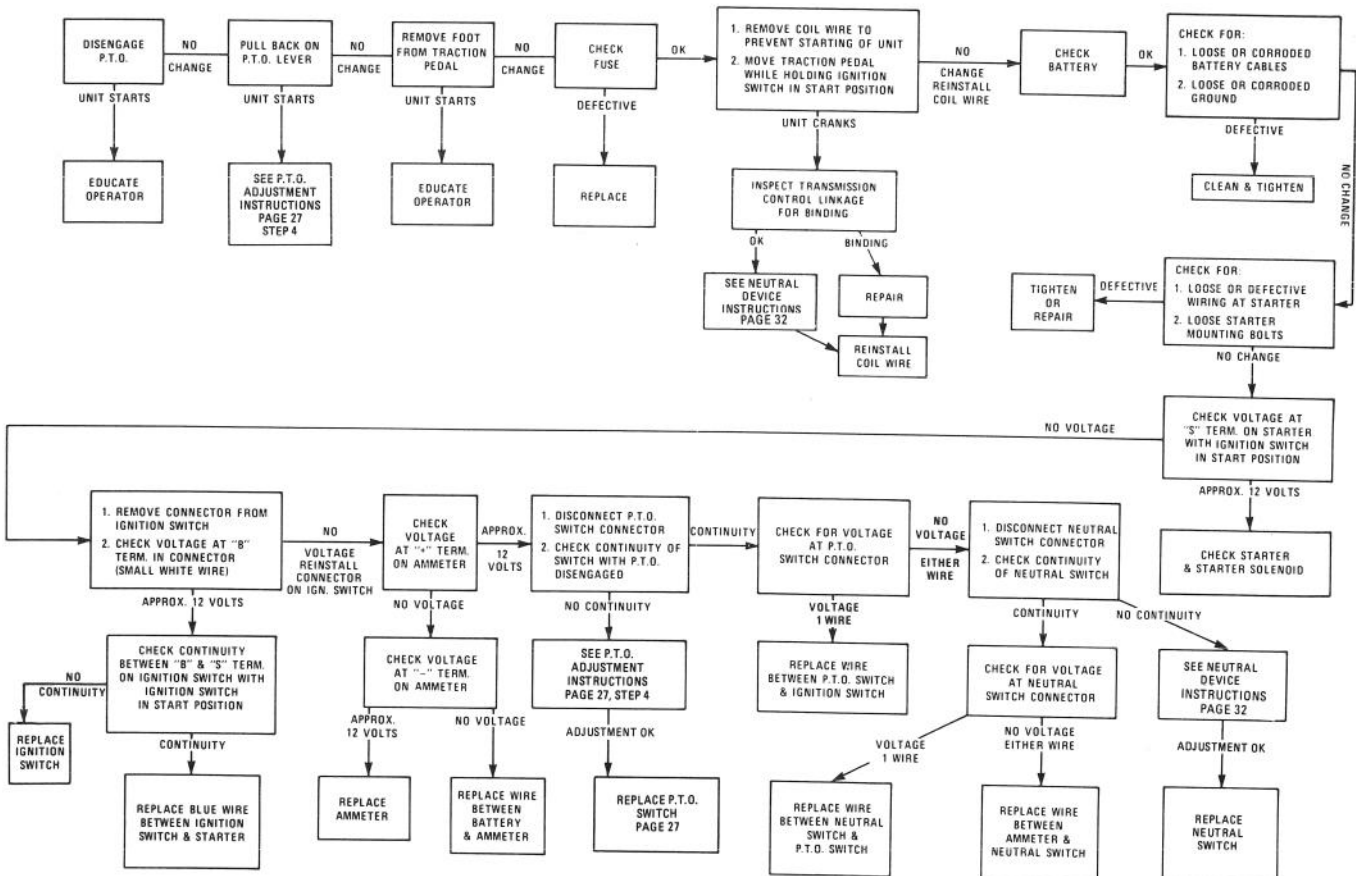

ELECTRICAL MAINTENANCE TROUBLESHOOTING

PROBLEM: ENGINE CRANKS, BUT WILL NOT START (IF ENGINE CRANKS, INTERLOCK CIRCUIT IS NOT AT FAULT).

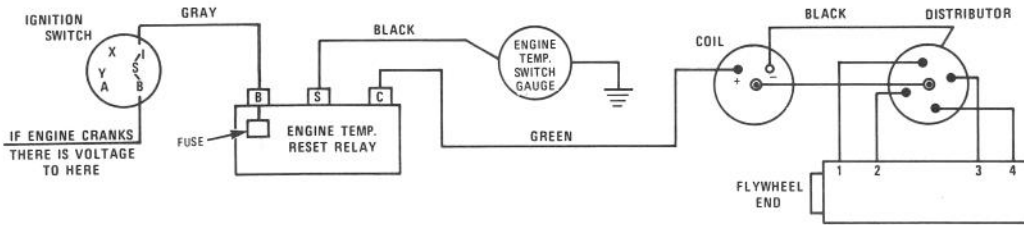

CIRCUIT INVOLVED WITH IGNITION

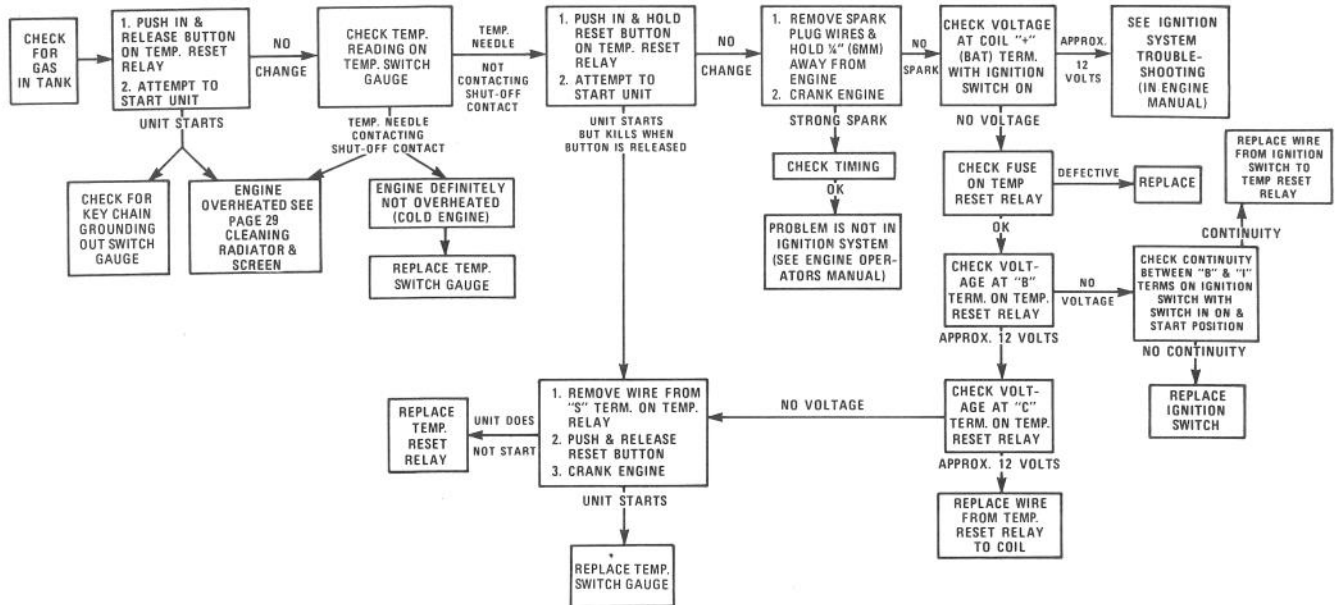

PROBLEM: ENGINE CRANKS, BUT SHOULD NOT, WHEN TRACTION PEDAL IS DEPRESSED.

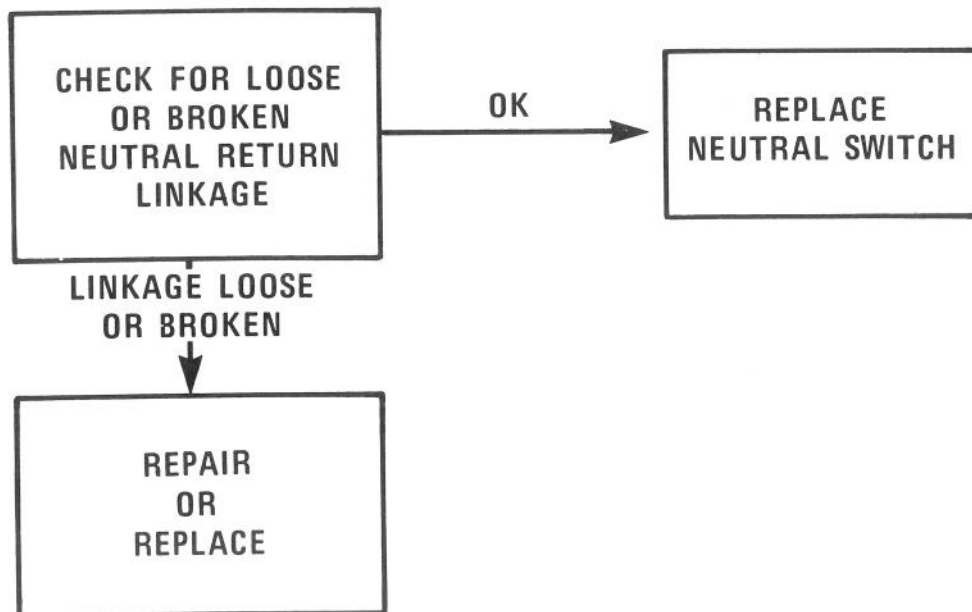

ELECTRICAL MAINTENANCE TROUBLESHOOTING

PROBLEM: ENGINE CRANKS, BUT SHOULD NOT, WHEN P.T.O. IS ENGAGED.



PROBLEM: ENGINE STARTS BUT KILLS WITH OPERATOR ON SEAT AND TRACTION PEDAL OR P.T.O ENGAGED. (ENGINE NOT OVERHEATED)

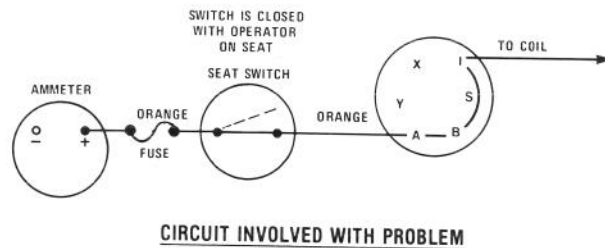
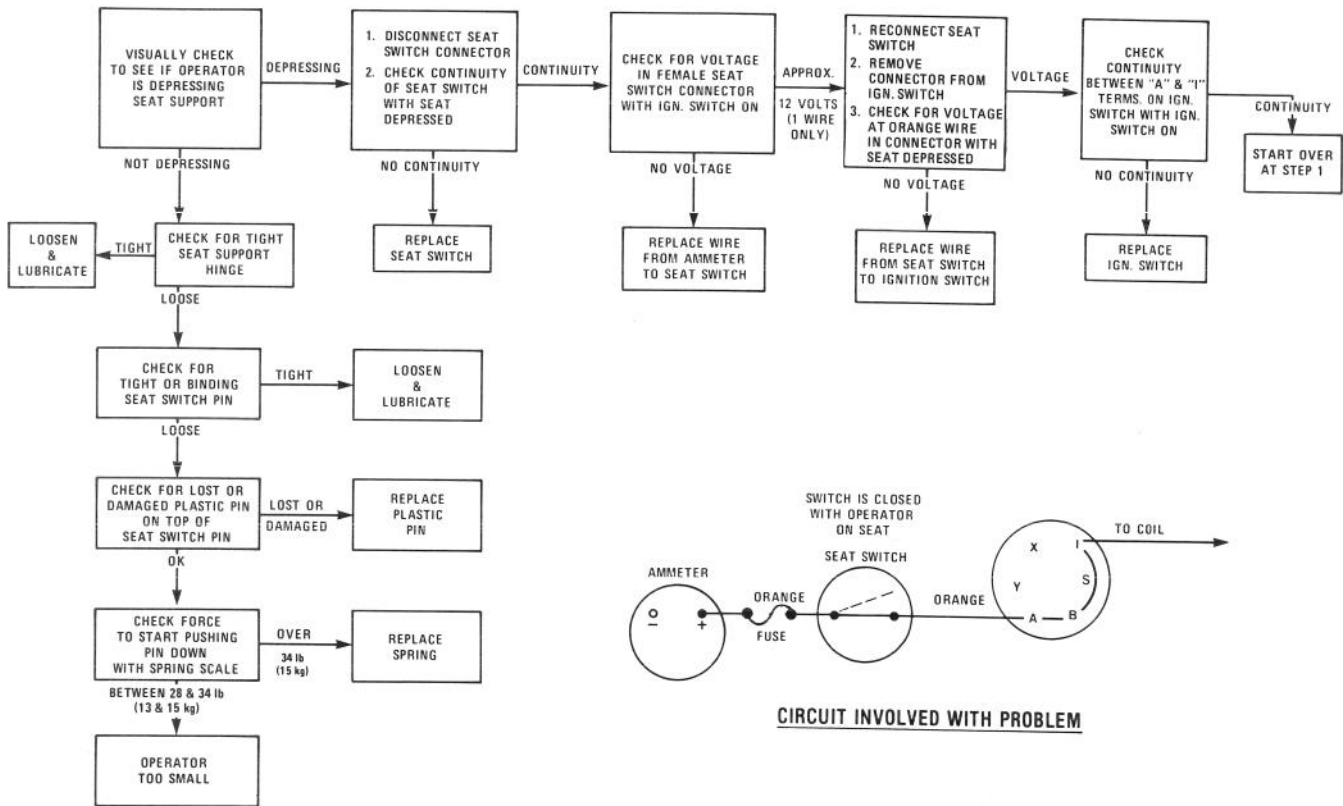

ELECTRICAL MAINTENANCE TROUBLESHOOTING

**PROBLEM: ENGINE CONTINUES TO RUN, BUT SHOULD NOT, WHEN TRACTION PEDAL IS ENGAGED WITH NO OPERATOR ON SEAT.
(NEUTRAL RETURN DEVICE WORKING PROPERLY)**

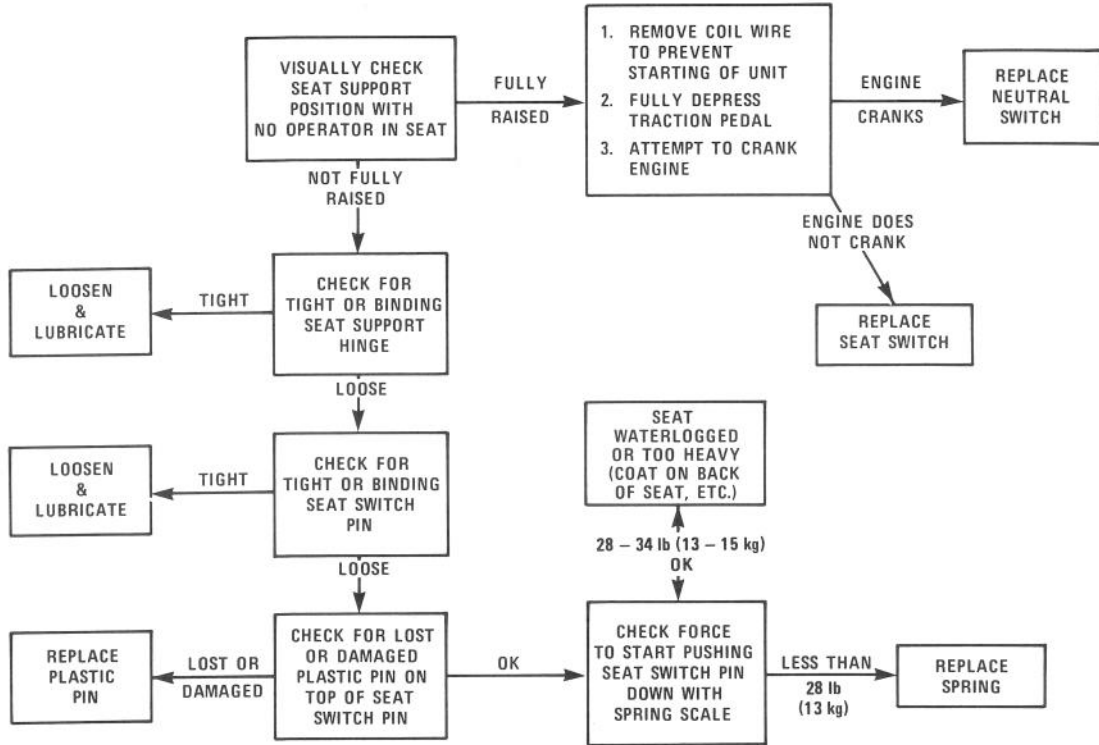

PROBLEM: ENGINE CONTINUES TO RUN, BUT SHOULD NOT, WHEN P.T.O. IS ENGAGED WITH NO OPERATOR ON SEAT.

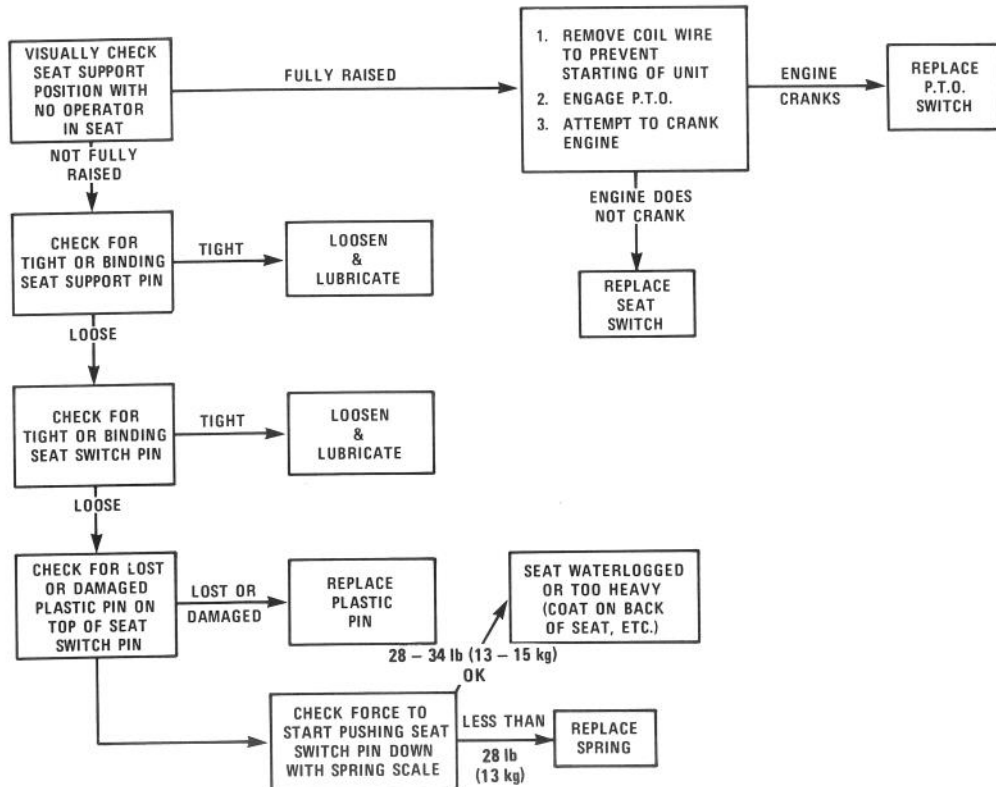

ELECTRICAL MAINTENANCE TROUBLESHOOTING

PROBLEM: THERE IS VOLTAGE AT "S" TERM ON STARTER
BUT STARTER WILL NOT CRANK.

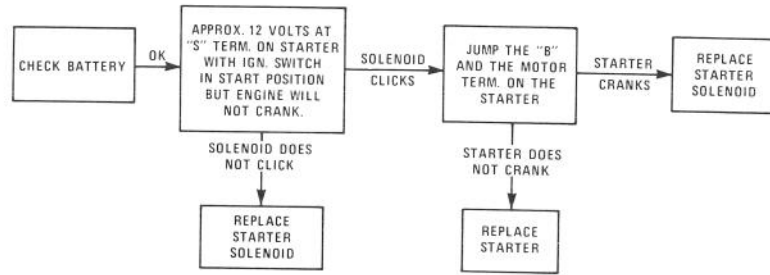
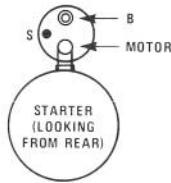

WIRING SCHEMATIC

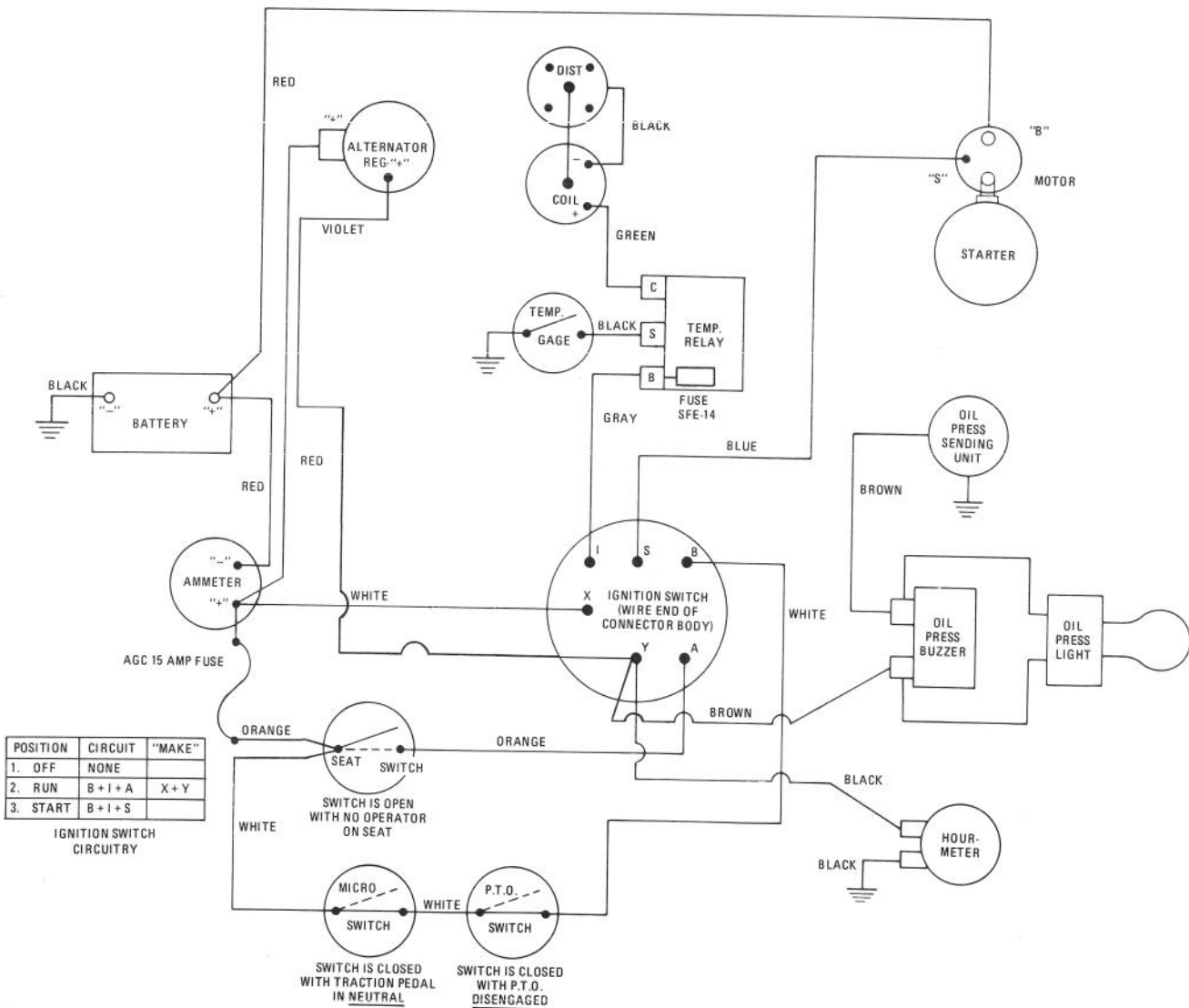

ELECTRICAL MAINTENANCE

REPLACING SEAT SWITCH

1. Raise seat and hold it up with seat support rod.
2. Remove instrument cover, disconnect negative battery cable from battery and separate wire harness connectors (Fig. 34). Remove capscrew and locknut (Fig. 34) and lift switch up to disengage locating pin on bottom of switch from hole in mounting bracket.

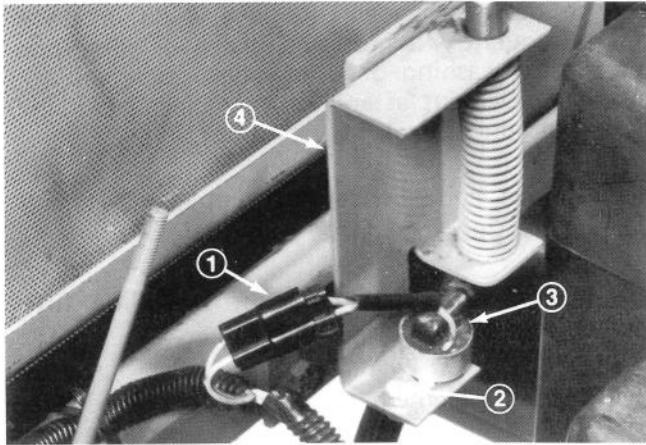

Figure 34

- | | |
|-------------------------|---------------------|
| 1. Connectors | 3. Switch |
| 2. Capscrew and locknut | 4. Mounting bracket |

3. To install new switch, set it on mounting bracket (Fig. 34) and insure locating pin on bottom of switch fits into hole in bracket. Secure switch in place with capscrew and locknut.

4. Liberally coat inside of connectors with Grafo 112X (skin-over) grease, Toro Part No. 505-47 and push wire harness connectors together.

5. Disengage support rod from seat and move seat to its normal position. Install lynch pin through the rod to hold seat in place and reconnect negative battery cable to battery.

REPLACING PTO SWITCH

1. Disengage latches and remove instrument cover.
2. Disconnect negative battery cable from battery and separate wire harness connectors (Fig. 35).
3. Move PTO lever to the ON position. Then remove capscrew and locknut holding switch against mounting bracket (Fig. 35).
4. Install new switch with capscrews and locknut. Move PTO lever to OFF position. When lever is in its normal, released position, the switch arm must bend about 1/2 inch (13 mm) (Fig. 35). If switch arm does not bend 1/2 inch (13 mm), bend the mounting bracket to get the correct adjustment.

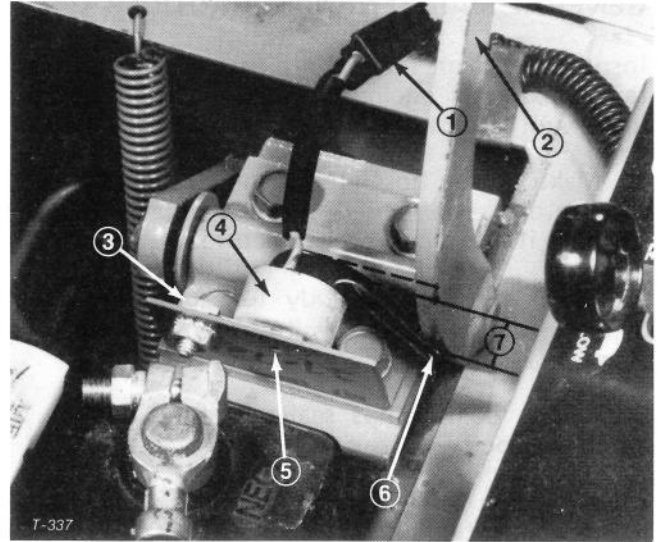

Figure 35

- | | |
|-------------------------|---------------------|
| 1. Connectors | 5. Mounting bracket |
| 2. PTO lever | 6. Switch arm |
| 3. Capscrew and locknut | 7. 1/2 inch (13 mm) |
| 4. Switch | |

5. Liberally coat inside of connectors with Grafo 112X (skin-over) grease, Toro Part No. 505-47 and push wire harness connectors together and reconnect negative battery cable to battery.

6. Install instrument cover and lock the latches.

SERVICING BATTERY

IMPORTANT: Before welding on the machine, disconnect ground cable from the battery to prevent damage to the electrical system.

Once a week or after every 50 operating hours, check electrolyte solution in the battery to make sure level is above the plates. If level is low, add water to the affected cells. The electrolyte solution in the battery consists of sulfuric acid and distilled water. The "charge state" of the battery affects specific gravity — weight — of electrolyte solution. As the battery discharges, sulfuric acid is chemically withdrawn from electrolyte solution, resulting in lead sulfate build-up on the plates. This causes a decrease in specific gravity of electrolyte. A fully charged battery has an electrolyte solution of 1.260 to 1.280 specific gravity. By contrast, battery with a solution of less than 1.240 is in a discharged condition; therefore charging is required.

Note: Keep terminals and entire battery case clean because a dirty battery will discharge slowly. To clean the battery, wash the entire case with solution of baking soda and water. Rinse with clear water. Do not get soda solution into the battery because damage to the battery will result. Coat the battery posts and cable connectors with Grafo 112X (skin-over) grease, Toro Part No. 505-47 or petroleum jelly to prevent corrosion.

AIR CLEANER MAINTENANCE

GENERAL MAINTENANCE PRACTICES

Inspect air cleaner and hose periodically to maintain maximum engine protection and to ensure maximum service life.

1. Make sure hose between air cleaner and carburetor is clamped securely in place. Replace the hose if it is cracked or punctured.
2. Check air cleaner body for dents and other damage which could possibly cause an air leak. Replace a damaged air cleaner body.
3. Assure dust cap is sealing around bottom of air cleaner body.
4. Mounting screws and nuts holding air cleaner in place must be tight.
5. Inlet cap must be free of obstructions.

SERVICING DUST CUP AND BAFFLE

Inspect the dust cup and rubber baffle once a week; however, daily or more frequent inspection is required when operating conditions are extremely dusty and dirty. Never allow dust to build up closer than one inch (25 mm) from the rubber baffle.

Note: If conditions are extremely dusty and dirty, begin by checking dust cup and baffle after each day's operation to establish approximately how long an interval passes before dust cup should be emptied. Base further maintenance requirements on this figure. These conditions may be particularly prevalent if the rear discharge cutting unit is attached.

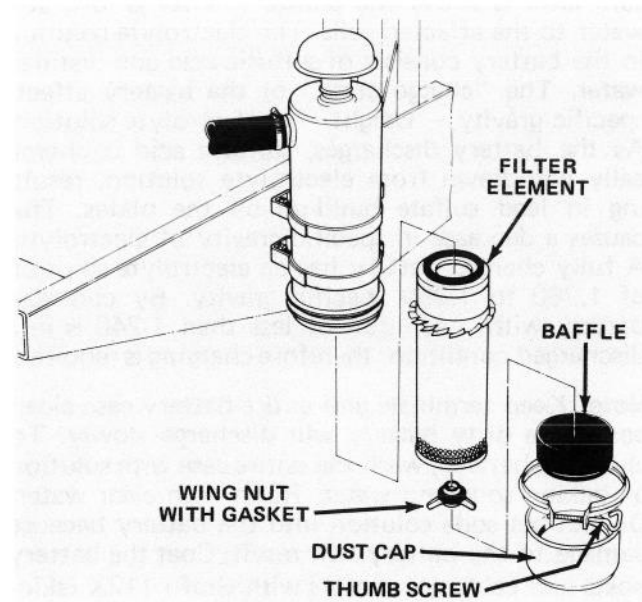

Figure 36

1. Loosen thumb screw until dust cup and baffle can be removed (Fig. 36). Separate dust cup and baffle (Fig. 36).
2. Dump dust out of the dust cup. After cleaning cup and baffle, assemble and reinstall both parts.

SERVICING AIR CLEANER FILTER

Service the air cleaner filter every 250 hours or more frequently in extreme dusty or dirty conditions by washing or using compressed air. Replace the element after every six cleanings (1500 hours) or annually whichever comes first.

1. Remove and service dust cup; refer to Servicing Dust Cup and Baffle, page 28.
2. Remove wing nut w/gasket and slide filter element out of air cleaner body (Fig. 36).
3. Clean the element by washing it in a solution of filter cleaner (part no. 27-7220, available from Toro) and water, or blow dirt out of filter by using compressed air.

Note: Compressed air is recommended when element must be used immediately after servicing because a washed element must be dried before it is used. By comparison, washing the element cleans better than blowing dirt out with compressed air. Remember though, filter must be washed when exhaust soot is lodged in the filter pores.

Washing Method

IMPORTANT: Do not remove plastic fin assembly because washing removes dust from beneath fins.

- A. Prepare a solution of filter cleaner and water and soak filter element about 15 minutes. Refer to directions on filter cleaner carton for complete information.
- B. After soaking filter for 15 minutes, rinse it with clear water. Maximum water pressure must not exceed 40 psi (276 kPa) to prevent damage to the filter element.
- C. Dry filter element using warm, flowing air (160° F (71°C) max). or allow element to air-dry. Do not use compressed air or a light bulb to dry the filter element because damage could result.

AIR CLEANER MAINTENANCE

Compressed Air Method

IMPORTANT: Do not remove plastic fin assembly because back-blowing with compressed air removes dust from beneath fins.

- A. Blow compressed air from inside to the outside of dry filter element. Do not exceed 100 psi (689 kPa) to prevent damage to the element.
- B. Keep air hose nozzle at least one inch (25 mm) from pleated paper, and move nozzle up and down while rotating the filter element. Inspect element when dust and dirt are removed; refer to Inspecting Filter Element, page 29.

4. Wipe inside of air cleaner body with a damp cloth to remove excess dust. Slide filter into air cleaner body and secure it in place with wing nut and gasket.

5. Reinstall dust cup and baffle. Move thumb screw behind air cleaner body and tighten it securely.

INSPECTING FILTER ELEMENT

1. Place bright light inside filter.
2. Rotate filter slowly while checking for cleanliness, ruptures, holes and tears. Replace defective filter element.
3. Check fin assembly, gasket and screen for damage. Replace filter if damage is evident.

ENGINE MAINTENANCE

CLEANING RADIATOR AND SCREEN

The screen and front of the radiator must be kept clean to prevent the engine from overheating. Normally, check the screen and front of radiator daily and, if necessary, clean any debris off these parts. However, it will be necessary to check and to clean the screen each quarter hour and radiator checked every hour in extremely dusty and dirty conditions. **Note:** This situation may be particularly prevalent if the rear discharge cutting unit is being used. The front of the radiator can be cleaned thoroughly by spraying with a water hose or blowing with compressed air from the fan side of the radiator. Make sure to clean out any debris that settles to the bottom of the screen. The screen in front of radiator can be removed — by loosening wing nuts at top of screen — to make cleaning easier.

REPLACING FUEL FILTER

Replace the fuel filter after every 250 hours of operation or yearly, whichever comes first.

1. Remove hose clamps from both ends of filter and pull hoses off filter (Fig. 37).



Figure 37

1. Fuel filter
2. Fuel pump

2. Slide hoses onto new filter and be sure arrow on side of filter points toward fuel pump.

3. Secure hoses on fuel filter with hose clamps.

ADJUSTING IDLE SPEED

The procedures for adjusting the carburetor are in the Engine Overhaul Manual. However, the idle speed setting in the engine manual, which is 600 to 650 rpm, must not be used. Toro recommends that the idle speed be set at 1500 rpm. Any lower rpm could cause transmission damage.

ENGINE MAINTENANCE

ADJUSTING CHOKE

1. Move dash-mounted choke control fully forward and open hood.
2. Clean dirt from around top of carburetor, loosen hose clamp and remove air cleaner hose from carburetor (Fig. 38).

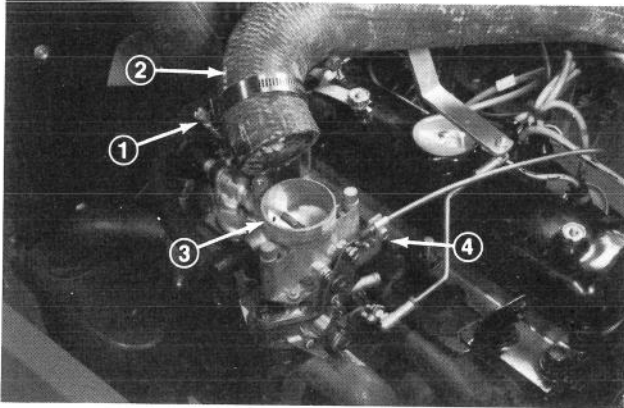

Figure 38

- | | |
|---------------------|----------------|
| 1. Hose clamp | 3. Choke plate |
| 2. Air cleaner hose | 4. Clamp screw |

3. If choke plate is not fully closed, loosen clamp screw (Fig. 38), hold choke plate closed and tighten the clamp screw.
4. Install air cleaner hose and tighten hose clamp.

ADJUSTING CHOKE IDLE SPEED

Choke idle speed screw (Fig. 39) should be adjusted to operate at 2000 rpm when the engine is "cold started".

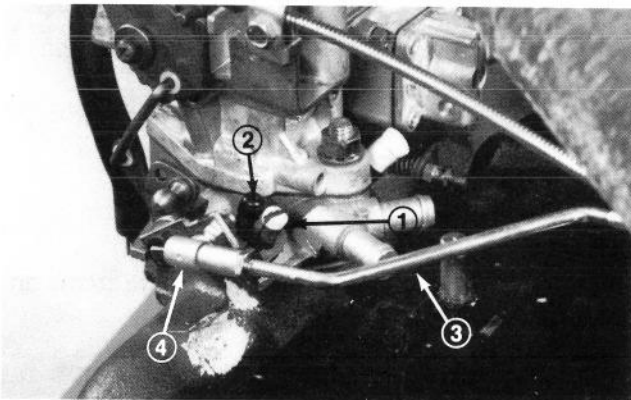

Figure 39

- | | |
|---------------------------|-----------------|
| 1. Idle speed screw | 3. Throttle rod |
| 2. Choke idle speed screw | 4. Ball joint |

1. Move dash-mounted choke control fully forward.
2. Mount tachometer to engine, start engine and adjust choke idle speed screw until engine operates at 2000 rpm.

CHECKING ENGINE TIMING

There are two timing marks on the flywheel. The saw-cut mark is TDC — top dead center — and the chisel mark 2° BTDC — before top dead center (Fig. 40). Time the engine to 2° BTDC at 700 to 800 rpm. After timing, set idle speed back at 1450 to 1550 rpm. Idle speed must be 1450 - 1550 rpm to prevent damage to the transmission.

ADJUSTING VALVE TAPPET AND TIGHTENING CYLINDER HEAD CAPSCREWS

The Engine Overhaul Manual recommends that the valve tappet clearance be adjusted and cylinder head capscrews tightened after every 500 hours of operation. However, Toro recommends that the valve tappet clearance be adjusted and cylinder head capscrews tightened after every 250 hours of operation. Refer to the Engine Overhaul Manual for procedures for adjusting the valve tappet clearance and tightening capscrews.

CHANGING COOLANT IN COOLING SYSTEM

The cooling system must be filled with a 50/50 solution of water and permanent ethylene glycol anti-freeze. The Toro Company strongly recommends the **use of an anti-freeze designed specifically for aluminum engines**. After every two years, drain the coolant from the radiator and engine by opening the drain cock and block plug. After coolant is drained, flush the entire system and refill it with a 50/50 solution of water and anti-freeze. Capacity of cooling system is approximately 6 quarts (5.7 L). When filling the radiator, level of coolant must be above the core and 1 inch (25 mm) below bottom of filler neck. **DO NOT OVERFILL**. Always install radiator cap securely.

ENGINE MAINTENANCE

ADJUSTING GOVERNOR

1. Move throttle control to FAST position and open hood. Check between the throttle arm and the stop on carburetor base to make sure there is 1/32 inch (0.794 mm) gap (Fig. 40). If gap is not correct, adjust throttle rod (Fig. 39) by turning ball joint ends until gap is 1/32 inch (0.794 mm). If gap is correct, proceed to step 2.

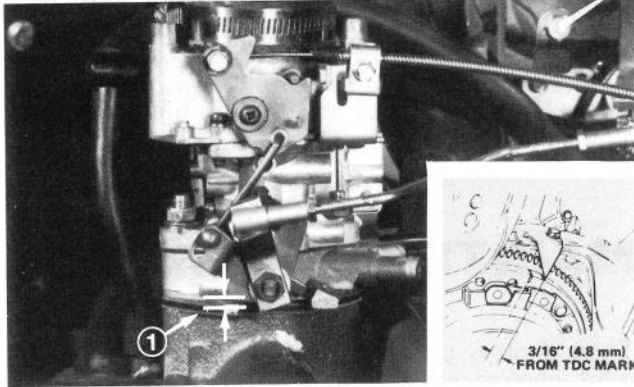

Figure 40

1. 1/32 in. (0.794 mm)

2. Start engine and move throttle to SLOW position. Allow engine to warm up to normal operating temperature and rotate idle screw (Fig. 39) to set idle at 1450 to 1500 rpm.

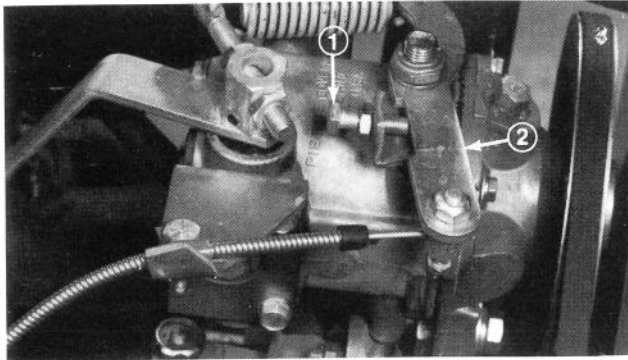

Figure 41

1. Stop screw 2. Throttle arm

3. Slowly move throttle to FAST position until engine speed reaches 3200 rpm. Then set stop screw against throttle arm (Fig. 41).

IMPORTANT: Do not overspeed the engine because the transmission could be damaged.

4. Move throttle rapidly from SLOW to FAST. The engine should not surge. If engine surges, proceed to step 5 for an adjustment.

5. Check V-belts from engine to governor pulley and crank shaft to water pump and assure they are tight. If belts are loose, the engine will surge. If belts are tensioned properly, loosen jam nut that retains the anti-surge screw (Fig. 42). Rotate screw clockwise 1/8 turn at a time until surging stops. Should governor continue to surge, check the following:

- A. Carburetor too rich or too lean.
- B. Incorrect timing.
- C. Faulty ignition.
- D. Binding in throttle linkage.
- E. Governor worn internally.

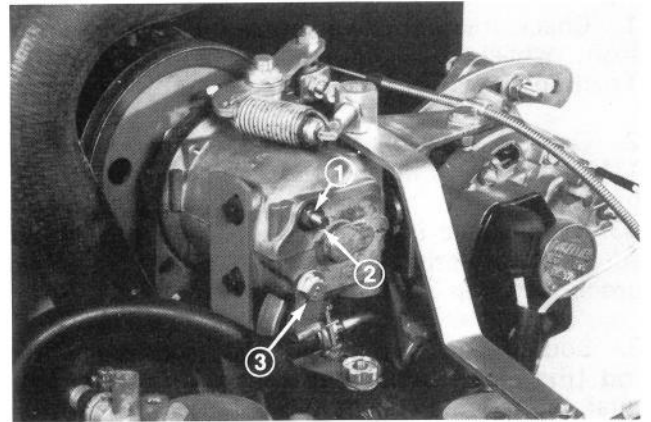

Figure 42

1. Jam nut 3. Oil check plug
2. Anti-surge screw

IMPORTANT: Never rotate anti-surge screw in too far so that speed of engine increases.

6. Bump the throttle lever with your hand so engine speeds up momentarily. If governor is working properly, engine speed should return to normal within one or two surges of the governor. More than two surges of the governor usually indicates that the anti-surge screw must be turned in slightly more than it is. When adjustment is correct, lock jam nut against governor body.

ENGINE MAINTENANCE

7. Check idle and full throttle speed to be sure there is no change from the initial setting. If speed has increased, anti-surge screw has been turned into the governor too far and it must be backed out. Then, repeat the entire adjustment procedure.

Note: If the throttle control on the instrument panel will not stay in the FAST position during operation, remove the panel cover and tighten the nut and capscrew at base of throttle lever assembly.

CHECKING OIL LEVEL IN GOVERNOR

The governor is shipped with oil in it, but level of

oil must be checked after every 250 hours of operation.

1. Position machine on level surface and shut engine off.

2. Disengage hood latch and open the hood. Remove check plug (Fig. 42). Level of oil must be up to bottom of filler hole. If level of oil is low, add same oil — SAE 5W-30 or 10W-40 — that is being used in the engine crankcase. When oil is at point of overflowing out of check plug hole, install the check plug.

TRACTION DRIVE MAINTENANCE

ADJUSTING TRACTION CONTROL ROD

1. Check traction drive neutral position to insure front wheels do not creep; refer to Adjusting Traction Drive For Neutral, page 32.

2. Depress traction pedal fully. There must be 1/16 inch (1.6 mm) between inside front edge of pedal and triangular support brace (Fig. 43). If distance is as specified, the control rod is adjusted correctly. If distance is not as specified, proceed to step 3 for an adjustment.

3. Loosen jam nut away from front of control rod (Fig. 43). Remove cotter pin and slotted nut retaining tapered socket in pivot mount on bottom of traction pedal (Fig. 43).

4. Adjust tapered socket as required. Slide end of tapered socket through traction pedal pivot mount.

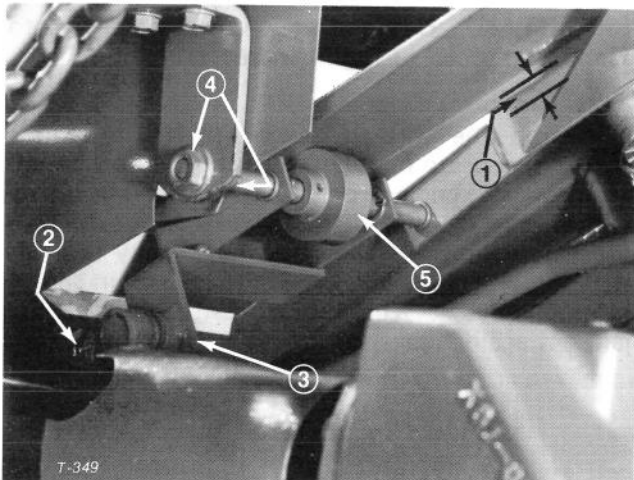

Figure 43

- | | |
|-------------------------------|-------------------|
| 1. 1/16 in. (1.6 mm) | 4. Nuts |
| 2. Jam nut | 5. Friction wheel |
| 3. Cotter pin and slotted nut | |

Then depress pedal and check for 1/16 inch (1.6 mm) clearance between front edge of pedal and top of support brace. Adjust tapered socket until correct adjustment results.

5. After control rod is adjusted correctly, secure tapered socket and traction pedal together with slotted nut and cotter pin. Also tighten jam nut against front of control rod.

ADJUSTING TRACTION PEDAL FRICTION WHEEL

1. Loosen two nuts securing traction pedal shaft on right side of pedal (Fig. 43).

2. Rotate shaft to relocate worn surface of friction wheel away from underside of traction pedal.

3. Tighten nuts to secure shaft and wheel in position.

ADJUSTING TRACTION DRIVE FOR NEUTRAL

The front wheels must not rotate when traction pedal and pump lever are in neutral position. If wheels rotate, an adjustment is required.

1. Park vehicle on a level surface and turn engine off. Apply the parking brake, tip seat forward and actuate pump lever (Fig. 44) to assure assembly is properly seated and operating freely. Correct any discrepancy.

2. Block right front tire and both rear tires so vehicle cannot roll forward or backward.

3. Jack up frame so left front wheel is off the shop floor. Use a jack stand to support the frame.

TRACTION DRIVE MAINTENANCE

4. Start engine and allow it to idle for 5 minutes to heat oil in transmission to operating temperature.

5. Release parking brake; then, check left front wheel that is off shop floor. Wheel must not be rotating. If wheel is rotating, proceed to step 6 for an adjustment. If wheel is not rotating, proceed to step 8. Verify the adjustment with throttle in SLOW and FAST position.

6. Because the wheel is rotating, the pump plate must be adjusted. But before adjusting the pump plate, move throttle to SLOW. If wheel is rotating forward, loosen capscrews and lightly tap bottom of pump plate counterclockwise (Fig. 44). By contrast, tap pump plate clockwise if wheel is rotating backward (Fig. 44). When wheel stops rotating, tighten capscrews holding pump plate against side of transmission. Verify the adjustment with throttle in SLOW and FAST position.

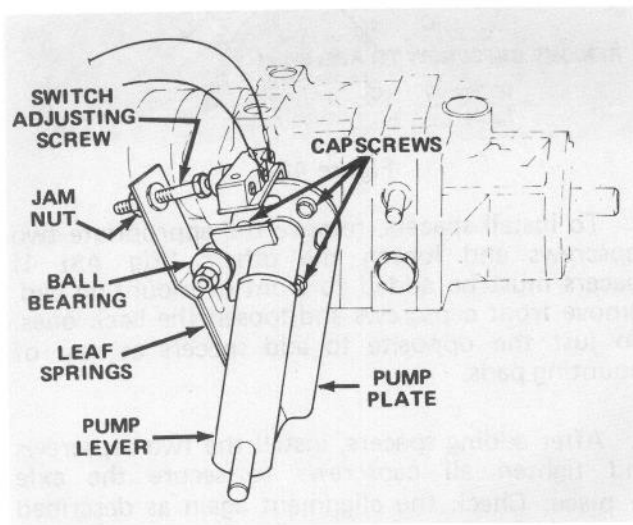

Figure 44

7. Should front wheels continue to rotate, check for the following:

- A. Ball bearing is loose or worn out (Fig. 44).
- B. Plunger on interlock switch is sticking.
- C. Loose or missing fasteners.
- D. Worn roll pin securing pump lever to transmission.
- E. Pump lever loose on control shaft. (Correct by applying Loc-tite 271 or 601 to Shaft).
- F. Weak or damaged leaf springs (Fig. 44). Replace.

G. Internal transmission component malfunction. Contact your local Toro distributor for assistance.

8. Shut engine off.

9. Adjust traction control rod; refer to Adjusting Traction Control Rod, page 32.

ADJUSTING TRACTION INTERLOCK SWITCH

1. Adjust transmission for neutral; refer to Adjusting Traction Drive for Neutral, page 32.

2. Actuate the pump lever (Fig. 44) to ensure all parts are operating freely and seated properly.

3. Loosen jam nut. Rotate switch adjusting screw (Fig. 44) until there is a gap between head of screw and switch button.

4. Rotate adjusting screw until it contacts the switch button. Continue to rotate the screw until the circuit is completed (switch "clicks"). After the switch clicks, rotate the adjusting screw an additional 1/2 turn. Tighten jam nut.

REMOVING DRIVE COUPLING

1. Lower cutting unit to the shop floor, shut engine off and engage parking brake.

2. Remove Drive coupling cover.

3. Remove two capscrews, lockwashers, flatwashers and spacers securing drive coupling assembly to engine pulley and two capscrews, flatwashers, small spacers and locknuts securing coupler to transmission hub (Fig. 45). Slide assembly out after capscrews are removed.

4. If drive coupling assembly must be disassembled, separate rubber couplings from power shaft by removing four nuts, flatwashers, capscrews and spacers (Fig. 45).

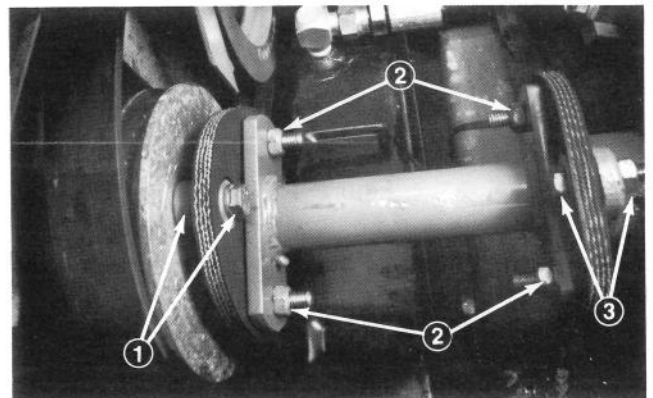

Figure 45

- 1. Capscrews, lockwashers, flatwashers, thick spacers (2)
- 2. Capscrews, flatwashers, locknuts (4), thin spacers
- 3. Capscrews, flatwashers, locknuts (2), thin spacers

TRACTION DRIVE MAINTENANCE

INSTALLING DRIVE COUPLING

1. Assemble rubber couplings and power shaft with capscrews, spacers, flatwashers and nuts (Fig. 45).
2. Position drive coupling assembly between engine pulley and transmission hub, and align the holes. Secure drive coupling between pulley and hub with capscrews, lockwashers and flatwashers (Fig. 45). Tighten the capscrews alternately and evenly to prevent distortion of the rubber coupling.
3. Install drive coupling cover.

CHECKING DRIVE COUPLING ALIGNMENT

When either the axle or engine is removed, alignment of the drive coupling must be checked after parts are installed. In addition, any excess vibration usually indicates misalignment of the drive coupling. The drive coupling will be damaged when misalignment is more than 1/8 inch (3 mm).

1. Check alignment of drive couplings, place square end of ruler or scale against face of drive pulley and bottom of coupling retainer to check vertical alignment (Fig. 46). Also, place ruler or scale against face of drive pulley and side of coupling to check horizontal alignment (Fig. 46). If there is more than 1/8 inch (3 mm) between ruler or scale and opposite coupling retainer, or the scale is more than 1/8 inch (3 mm) higher than bottom of coupling during vertical alignment check or scale does not align within 1/8 inch (3 mm) of side of coupling, an adjustment is required. To correct for misaligned drive coupling, proceed to step 2.

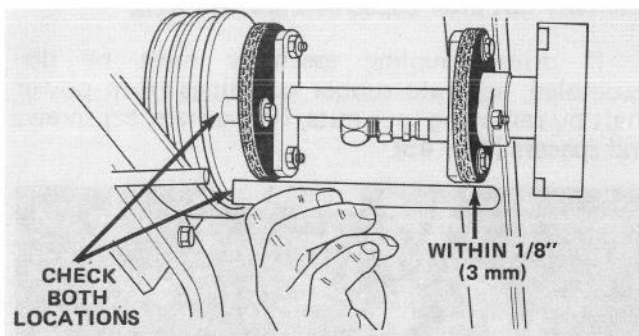

Figure 46

2. To correct vertical misalignment, loosen axle support nuts at rear of floor plate (Fig. 47). A transmission that is too high will have a gap between the scale and the coupling retainer. To correct this problem, install a 1/16 inch (1.6 mm) spacer between rear of mounting pad and bottom of

frame (Fig. 48). By contrast, a transmission that is too low will not allow the ruler or scale to lay alongside the coupling retainer. To correct this problem, install a 1/16 inch (1.6 mm) spacer between front of mounting pad and bottom of frame.

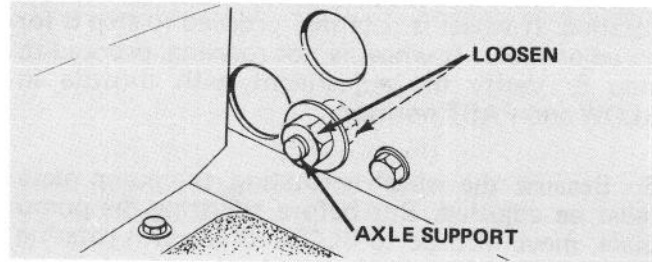

Figure 47

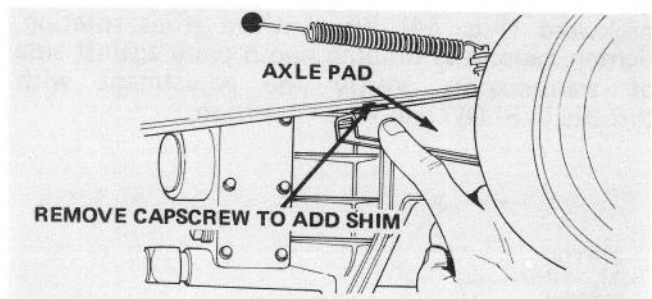

Figure 48

3. To install spacers, remove the appropriate two cap screws and loosen the others (Fig. 48). If spacers must be added to front of mounting pad, remove front cap screws and loosen the back ones. Do just the opposite to add spacers at rear of mounting pads.

4. After adding spacers, install the two cap screws and tighten all cap screws to secure the axle in place. Check the alignment again as described in step 1. Continue to check the alignment and add shims as required. When alignment is correct, tighten the axle support nuts. Tighten rear nut with fingers until it contacts the frame. Then tighten front nut securely.

5. To correct horizontal misalignment, leave the drive axle free by supporting the machine frame on jack stands and loosen the four cap screws securing the axle to the frame just enough to allow the axle to be moved.

6. Use a hammer or pry bar to move the left side of the axle forward or rearward to achieve proper horizontal alignment (left hand axle mounting pad holes are slotted) and tighten all the cap screws to secure the axle to the frame.

PTO DRIVE MAINTENANCE

REPLACING PTO DRIVE BELT

1. Lower implement to the shop floor, shut engine off and engage the parking brake.
2. Remove drive coupling from between engine pulley and transmission hub; refer to Removing Drive Coupling, page 33.
3. Move PTO lever to the ON position and remove PTO brake (Fig. 49).
4. Move PTO lever to the OFF position to release tension on the belt. Roll old belt off engine pulley and PTO pulley (Fig. 49).

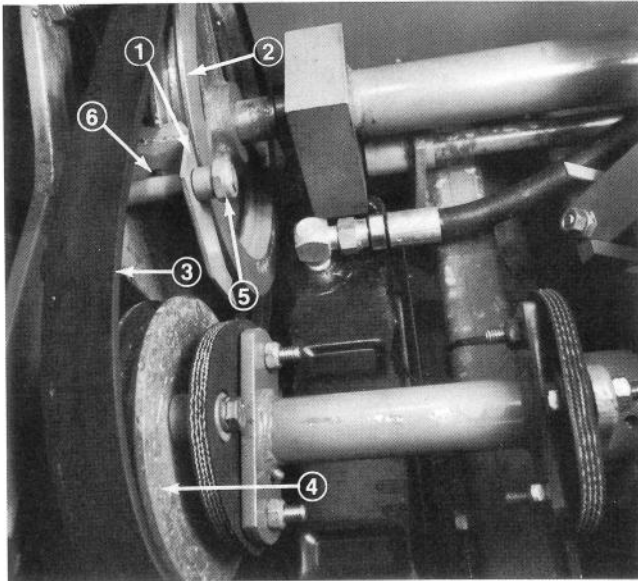

Figure 49

- | | | |
|---------------|------------------|-----------------------|
| 1. PTO brake | 3. Belt | 5. Spacer and locknut |
| 2. PTO pulley | 4. Engine pulley | 6. Locating pin |

5. To install new belt, roll belt onto PTO pulley and engine pulley, making sure belt is to the inside of the three belt guides.
6. Install PTO brake between the pulleys and adjust it; refer to Adjusting PTO Brake, page 35.
7. Install drive coupling between engine pulley and transmission hub; refer to Installing Drive Coupling, page 34.

ADJUSTING PTO BRAKE

1. Lower implement to the shop floor, shut engine off and engage the parking brake.
2. Move PTO lever to ENGAGE position. Loosen adjusting locknut (Fig. 49). so brake is free to move. Then move PTO lever to OFF and position the brake in grooves of pulley.
3. Tighten locknut until spacer contacts brake.

REPLACING PTO BRAKE

1. Lower implement to the shop floor, shut engine off and engage the parking brake.
2. Move PTO lever to the ENGAGE position to move pulley away from brake.

3. Remove locknut holding brake on mounting pin, and slide spacer, brake and spring off the pins (Fig 49).

4. To install new brake, slide spring onto large mounting pin. Then slide brake onto mounting pin and small locating pin.

5. Move PTO lever to OFF and position the brake in grooves of pulley. Slide spacer onto mounting pin and secure all parts in place with locknut. Tighten locknut until spacer contacts brake.

ALIGNING PTO PULLEY AND ENGINE PULLEY

1. Lower implement to the shop floor, shut engine off and engage the parking brake.

2. Move PTO lever to the ON position to move pulley away from brake. Remove locknut holding brake on mounting pin, and slide spacer, brake and spring off the pins.

3. Loosen set screws in lock collars at front and back of PTO pivot shaft (Fig. 50). Using a punch and hammer, loosen collars by driving them opposite the direction of normal shaft rotation. The PTO shaft and PTO pulley assembly should now be free to slide.

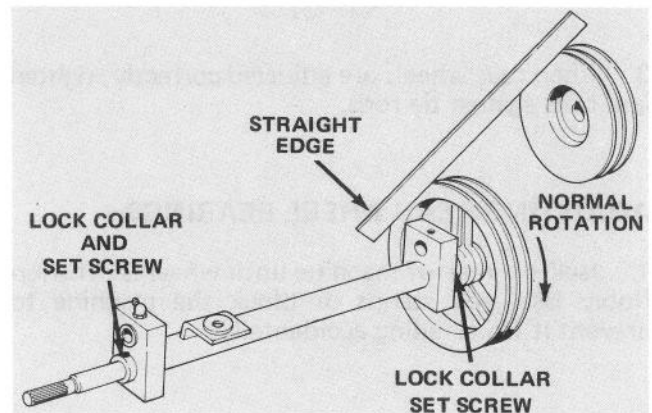

Figure 50

4. Using a straight edge, line up top of engine pulley, with top of PTO pulley (Fig. 50). When top of pulleys are aligned, bottom of pulleys are misaligned by 3°. Move PTO pulley until it is in line with the engine pulley. Then lock the pivot shaft and pulley in place by tightening the lock collars in the normal direction of shaft rotation (Fig. 50). Check alignment of pulleys again to assure alignment did not change when collars were tightened. If alignment is still correct, tighten lock collar set screws.

5. Slide spring onto large brake mounting pin. Then slide brake onto mounting pin and small locating pin.

6. Move PTO lever to OFF and position the brake in grooves of pulley. Slide spacer onto mounting pin and secure all parts in place with locknut. Tighten locknut until spacer contacts brake.

STEERING MAINTENANCE

ADJUSTING REAR WHEEL TOE-IN

The rear wheels should not toe-in or toe-out when they are adjusted correctly. To check the rear wheel toe-in, measure the center-to-center distance at wheel hub height, in front and in back of the rear tires. If the wheels toe-in or toe-out, an adjustment is required.

1. Rotate the steering wheel so rear wheels and steering plate are straight ahead.
2. Loosen the jam nuts on both tie rods. Adjust both tie rods until center-to-center distance at front and back of rear wheels is the same (Fig. 51).

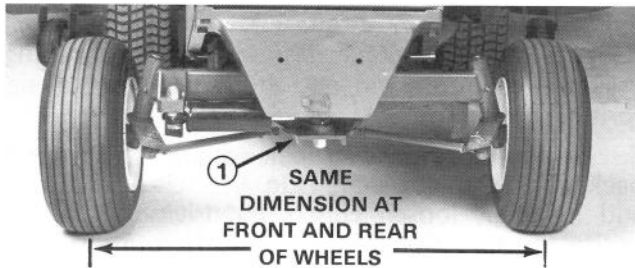

Figure 51
1. Steering plate

3. When rear wheels are adjusted correctly, tighten jam nuts against tie rods.

ADJUSTING REAR WHEEL BEARINGS

1. Jack up rear of machine until wheel is off shop floor. Use jack stands or block the machine to prevent it from falling accidentally.

2. Remove dust cap from end of wheel spindle. Also remove cotter pin retaining slotted nut in place (Fig. 52).

3. Rotate the wheel by hand and tighten the slotted nut until the bearing binds slightly. Then loosen nut until the nearest slot and hole in spindle line up. Install the cotter pin to retain the slotted nut in place.

4. Install dust cap on end of the wheel spindle.

5. Remove jack stands and lower machine to shop floor.

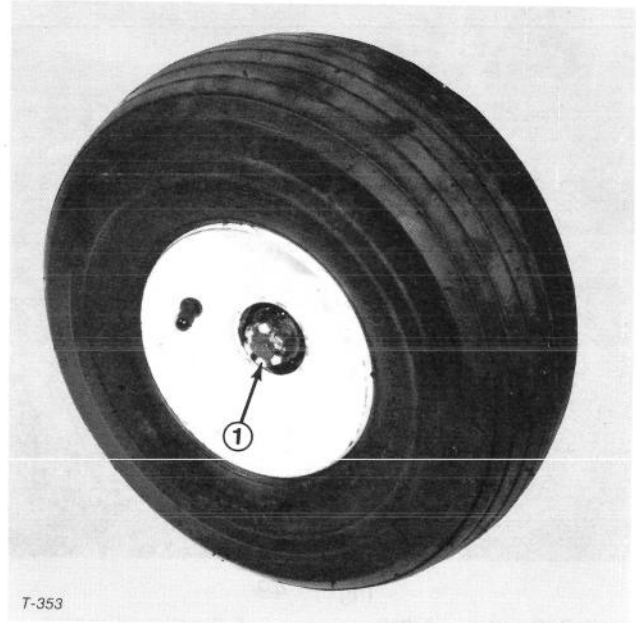

Figure 52
1. Slotted nut

BRAKE MAINTENANCE

ADJUSTING BRAKES

Adjust the service brakes when there is more than one inch (25 mm) of "free travel" of the turn pedals, or when the brakes do not work effectively. Free travel is the distance the brake pedal moves before braking resistance is felt.

The brakes should only need adjusting after considerable use, and these periodic adjustments can be performed where the brake cables connect to the brake pedal mount. When the cables are no longer

adjustable, the star nut on inside of the brake drum must be adjusted to move the brake shoes outward. However, the brake cables must be adjusted again to compensate for this adjustment.

1. To reduce free travel of turn pedals — tighten the brakes — loosen front nut on threaded end of brake cable (Fig. 53). Then tighten rear nut to move cable backward until turn pedals have 1/2 to 1 inch (13 to 25 mm) of free travel. Tighten front nut after brakes are adjusted correctly.

EDWARDS BRAKE MAINTENANCE

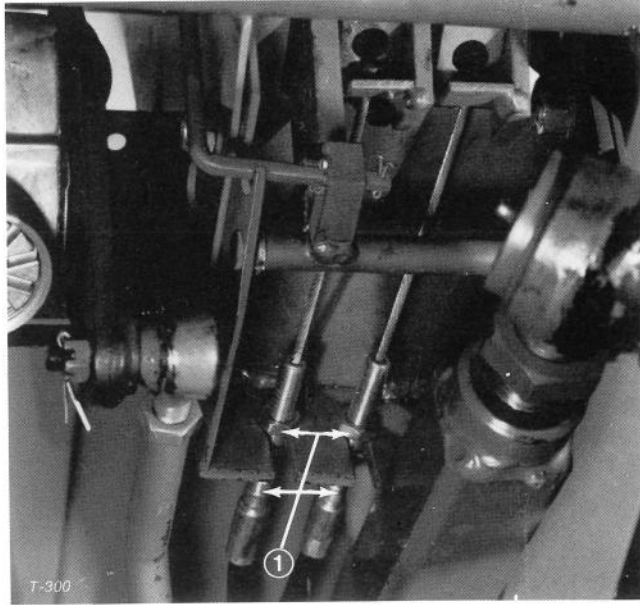

Figure 53
1. Jam nut

2. When adjustment of brake cables cannot get free travel within 1/2 to 1 inch (13 to 25 mm), the star-nut inside the brake drum must be adjusted. However, before adjusting the star nut, loosen brake cable nuts to prevent unnecessary strain on the cables.



Figure 54
1. Slot

3. Loosen five wheel nuts holding wheel and tire assembly on wheel studs.

4. Jack up machine until front wheel is off the shop floor. Use jack stands or block the machine to prevent it from falling accidentally.

5. Remove wheel nuts and slide wheel and tire assembly off studs. Rotate brake drum until adjusting slot is at bottom and centered over star-nut that adjusts brake shoes (Fig. 54).

6. Using a brake adjusting tool or screwdriver, rotate star-nut (Fig. 54) down until brake drum (Fig. 54) locks because of outward pressure of brake shoes (Fig. 55).

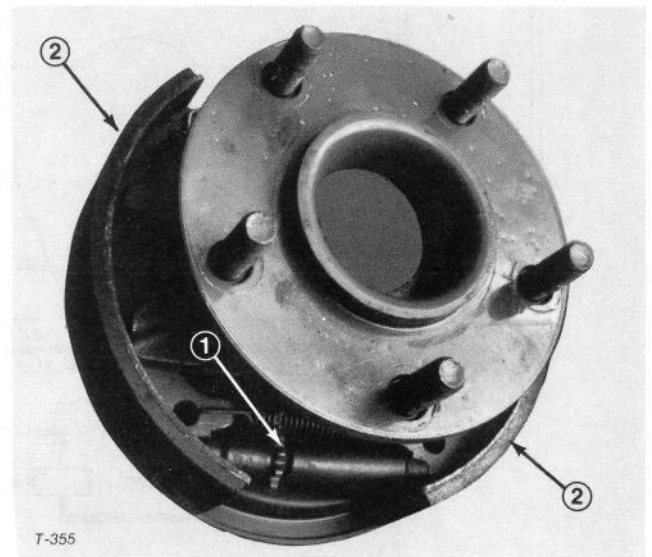

Figure 55
1. Star nut
2. Brake shoes

7. Loosen star-nut about 12 to 15 notches or until brake drum rotates freely.

8. Install wheel and tire assembly on studs with five wheel nuts. Tighten nuts to 45-55 ft-lb (61-75 N·m).

9. Remove jack stands or blocking and lower machine to the shop floor.

10. Adjust the brake cables using step 1.

HYDRAULIC SYSTEM MAINTENANCE

FORWARD TRACTION OPERATION

The hydrostatic transmission consists of a charge pump, variable displacement pump and a fixed displacement motor. The schematic (Fig. 56) shows flow of the hydraulic oil during forward operation.

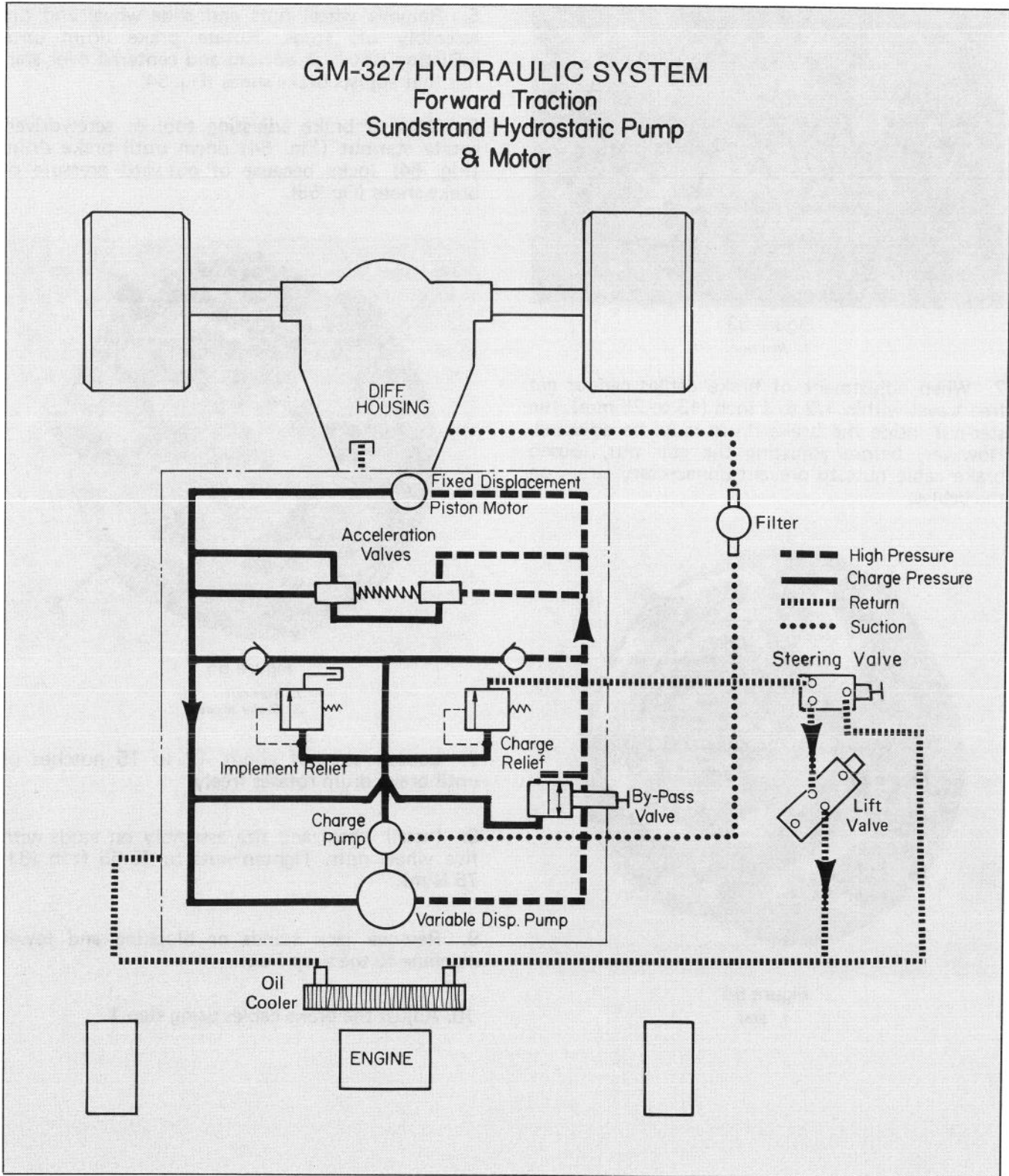

Figure 56

HYDRAULIC SYSTEM MAINTENANCE

REVERSE TRACTION OPERATION

The schematic (Fig. 57) shows flow of the hydraulic oil during reverse operation.

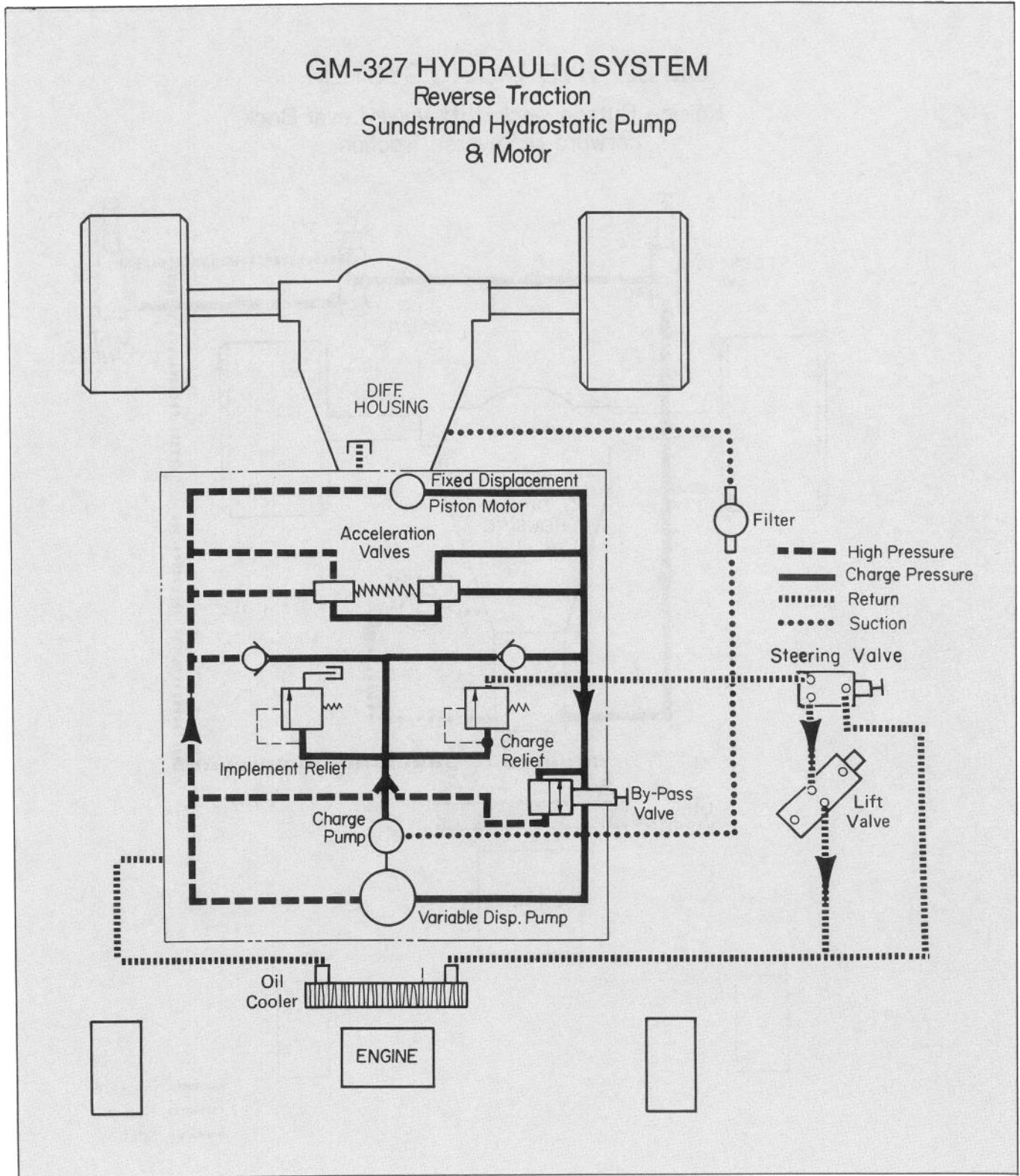

Figure 57

HYDRAULIC SYSTEM MAINTENANCE

LIFTING OPERATION

When lift lever is actuated to raise the cutting unit, the charge pump supplies oil thru the steering valve to the lift valve. Oil goes in one side of the lift valve, to the lift cylinder, out the lift cylinder, back to the lift valve, to the oil cooler and to the pump housing (Fig. 58).

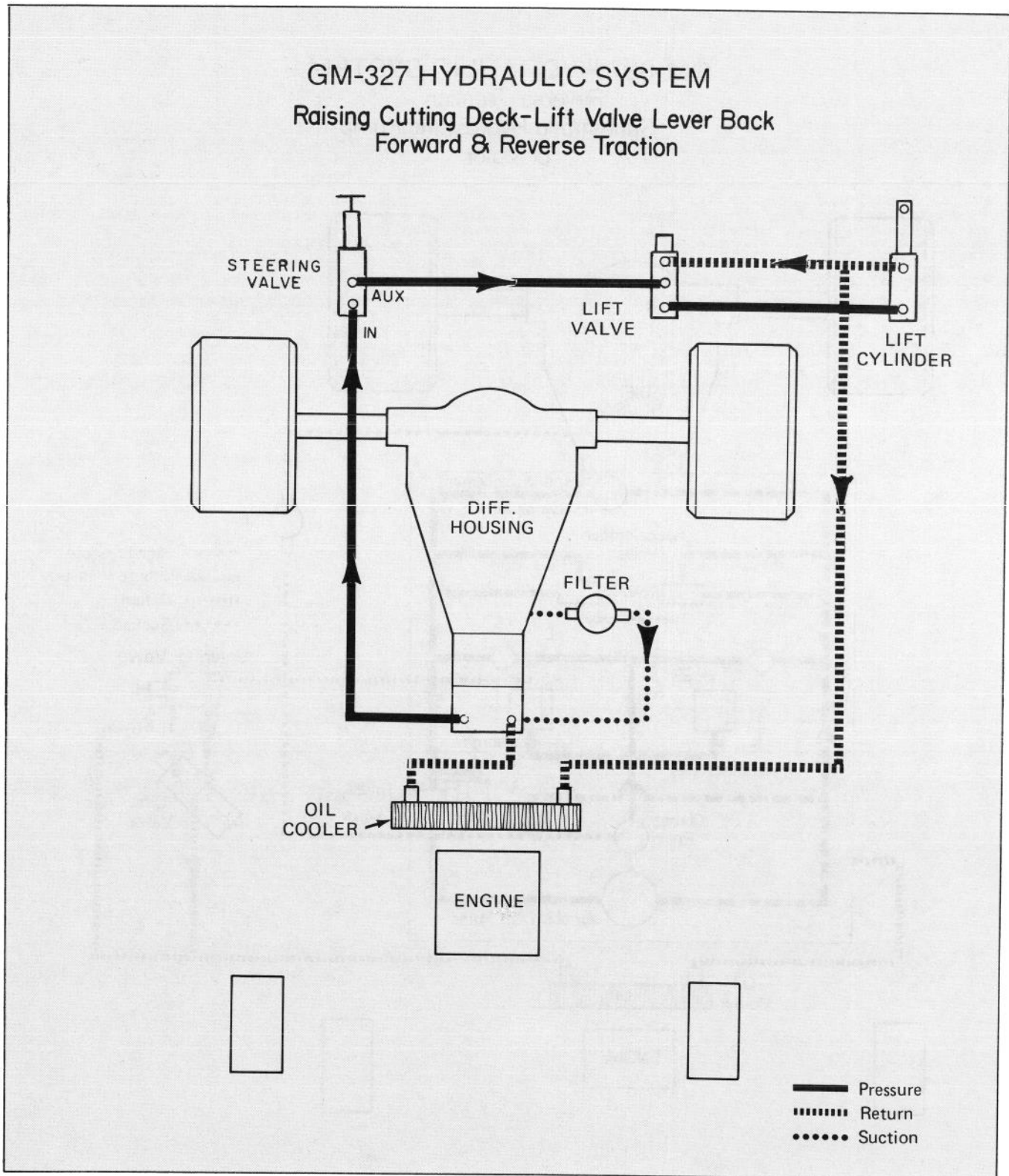
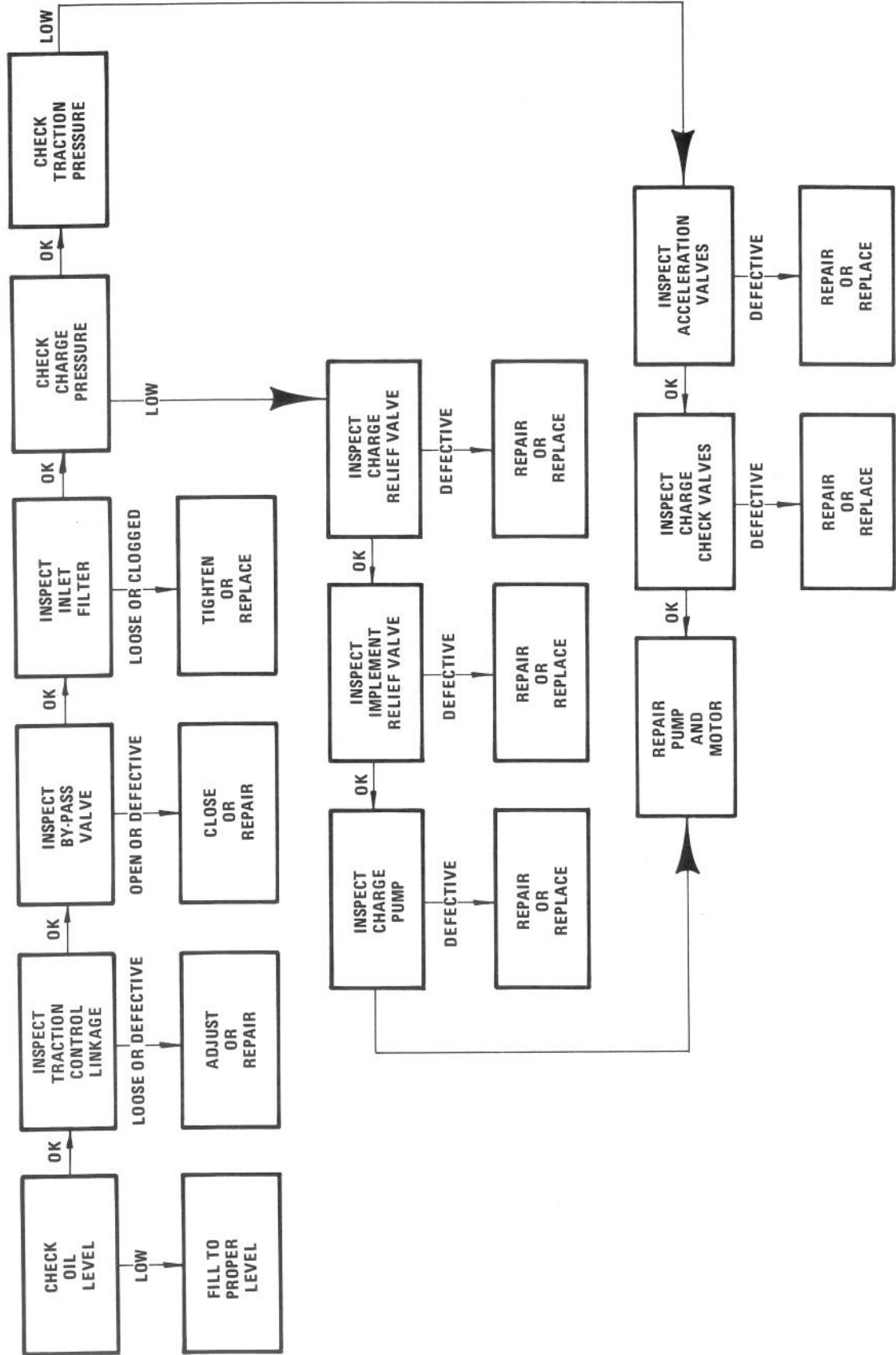

Figure 58

HYDRAULIC SYSTEM MAINTENANCE TROUBLESHOOTING

LOSS OF POWER OR UNIT WILL NOT OPERATE IN EITHER DIRECTION



HYDRAULIC SYSTEM MAINTENANCE TROUBLESHOOTING

SYSTEM OPERATES HOT

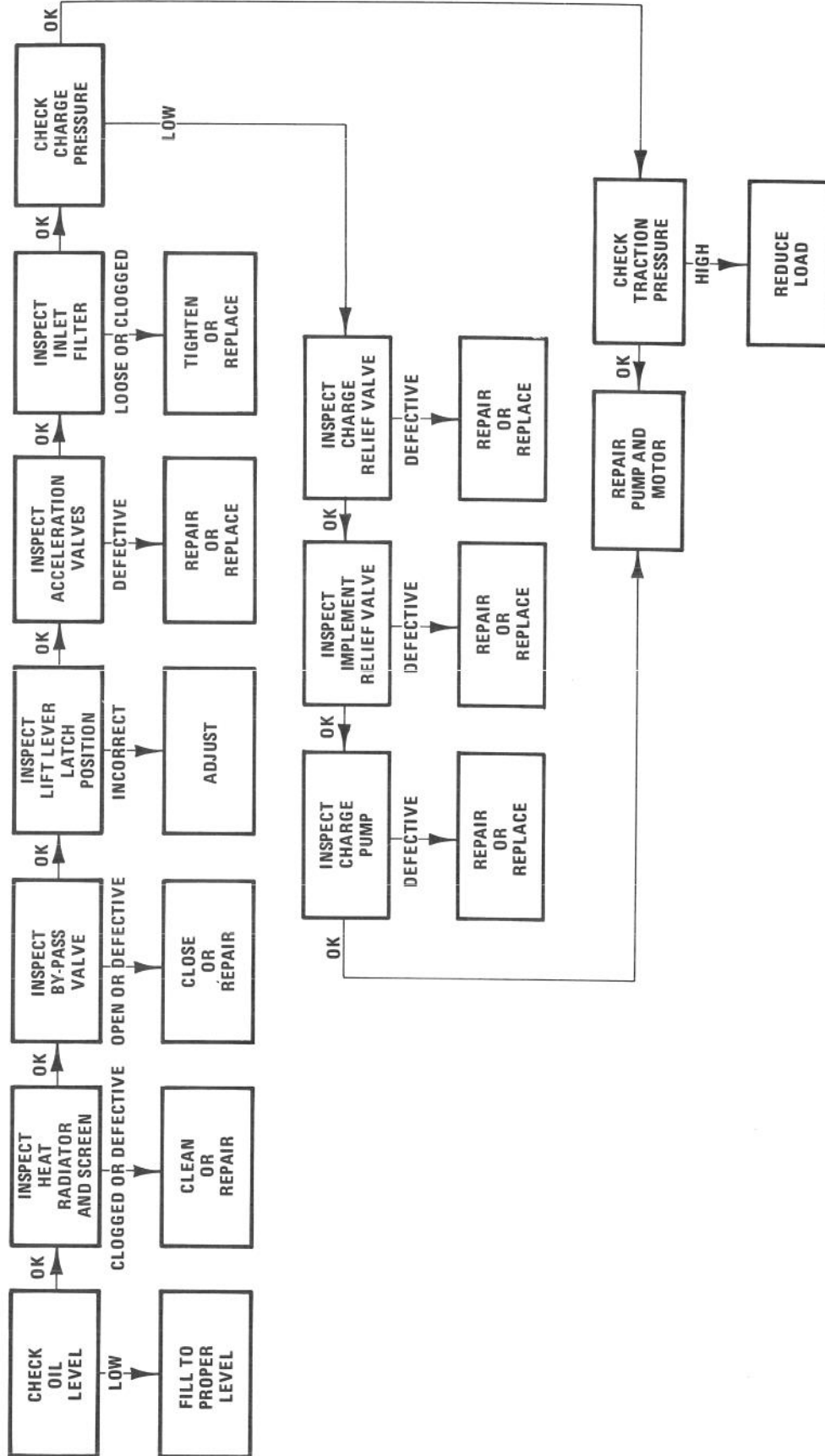

HYDRAULIC SYSTEM MAINTENANCE TROUBLESHOOTING

SYSTEM JERKY WHEN STARTING

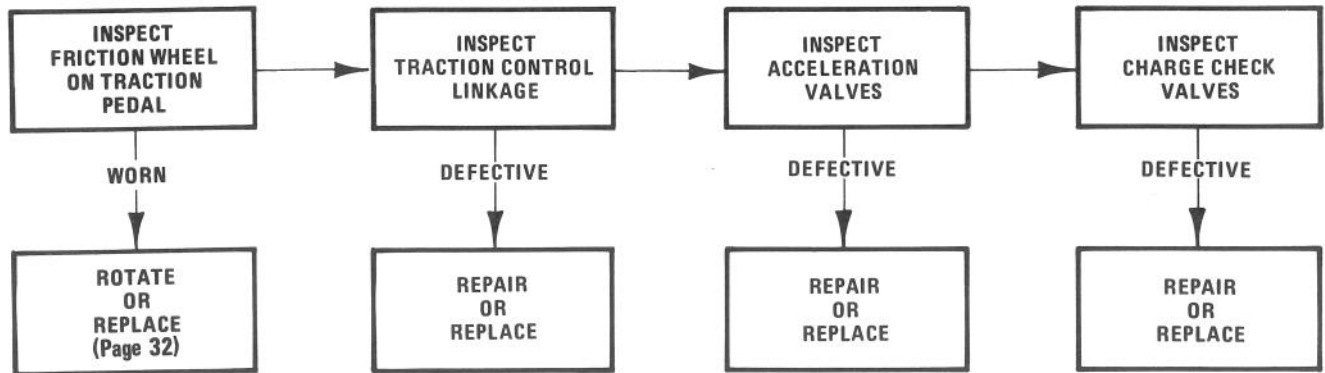

SYSTEM OPERATES IN ONLY ONE DIRECTION

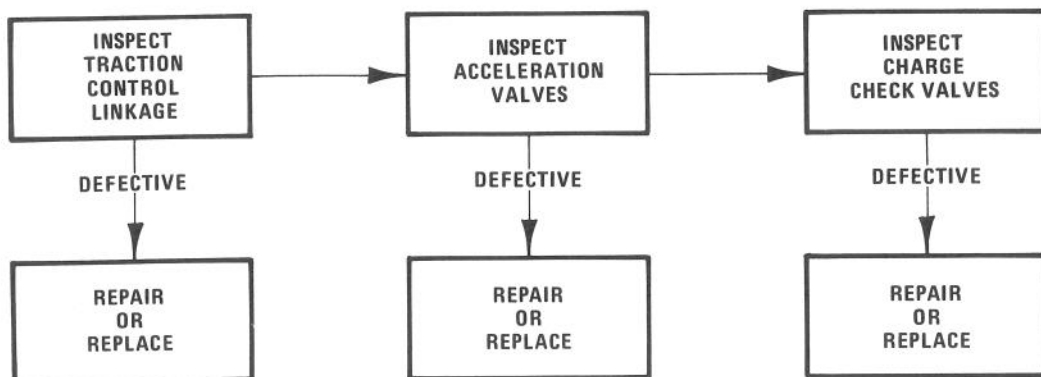

HYDRAULIC SYSTEM MAINTENANCE TROUBLESHOOTING

UNIT WILL NOT LIFT OR LIFTS SLOWLY

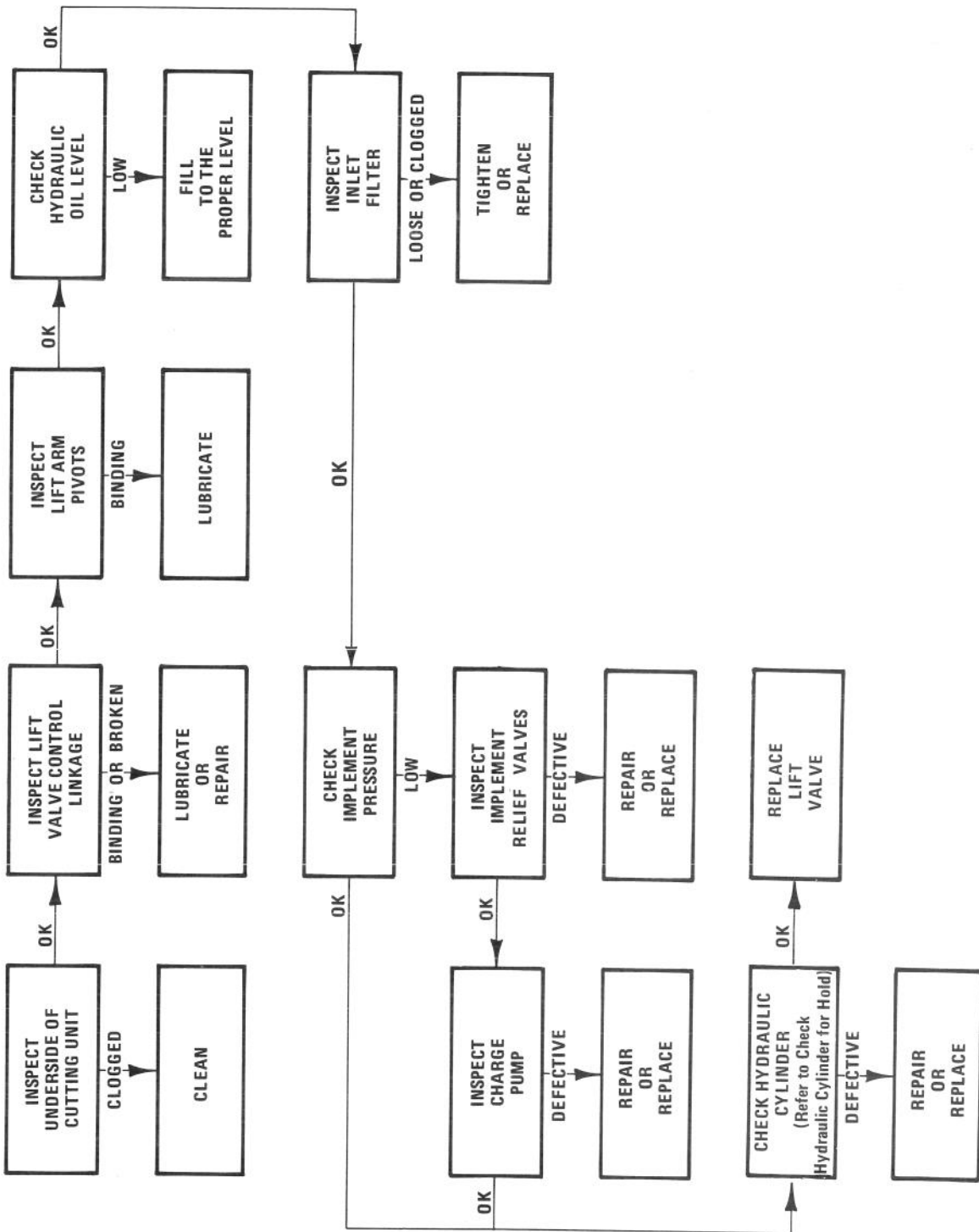

HYDRAULIC SYSTEM MAINTENANCE

ADJUSTING LIFT LEVER LATCH

A lift lever latch that is positioned incorrectly can cause the lift lever to hold the spool in an actuated position when the implement is in the FLOAT position. This will cause oil in the hydraulic system to overheat. When lift lever latch is adjusted correctly, the lift lever should just clear the rounded part of the latch as lever is moved into FLOAT position.

1. Unscrew ball from lift lever.
2. Remove self-tapping screws and lift cover off lift lever to expose the latch.
3. Loosen two capscrews on top of the lift lever latch (Fig. 59). Place lever on rounded tip of latch (Fig. 59), and slide latch w/lever forward until stopping resistance is felt. Then tighten the capscrews to lock the latch in place. Check for free operation of the lift lever by moving lever from RAISE or TRANSPORT to FLOAT position. Lift lever should just clear rounded portion of latch as lever is moved into FLOAT position.
4. Slide cover into place and install it with self-tapping screws. Screw ball onto lift lever.

REPLACING LIFT ARM BUSHINGS

1. Lower implement to the shop floor and shut engine off.
2. Unscrew ball from lift lever.
3. Remove self-tapping screws and lift cover off lift lever to expose the latch.

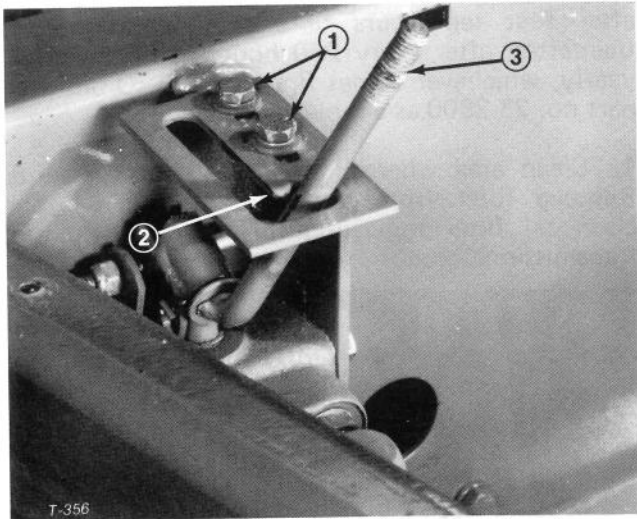

Figure 59

1. Capscrews
2. Rounded tab
3. Lift lever

4. Disconnect spring from front of lift cylinder cotter pin. Remove cotter pins and clevis pins to release chains from lift arm.

Note: Raise lift arm to extend cylinder and relieve spring tension on lift arm.

5. Remove spring pin from cylinder pin, and pull cylinder pin out of moveable end of the cylinder (Fig. 60).
6. Remove cotter pin and flatwashers from lift arm pivot shaft (Fig. 60).

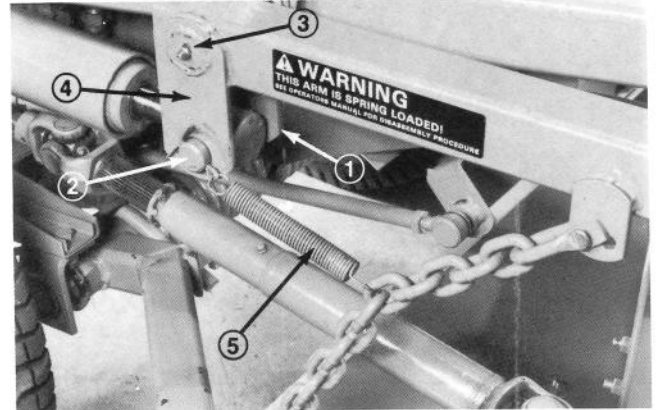

Figure 60

1. Spring pin
2. Cylinder pin
3. Pivot shaft
4. Lift arm
5. Spring

7. Slide lift arm out to the right until it is free of the main frame.
8. Using punch and hammer, drive bushings out of main frame pivot.
9. Press new bushings into main frame pivot.
10. Slide lift arm pivot shaft with spring through main frame pivot and insert free end of spring through hole in the frame. Secure parts in place with flatwashers and cotter pin. Then connect moveable end of lift cylinder to lift arm with cylinder pin and spring pin. Cotter pin must face to the outside.
11. Connect chains to lift arm with clevis and cotter pins.
12. Connect ends of tension spring between fourth link of rear chain and eye of cotter pin that holds cylinder pin in place.
13. Slide cover into place and install it with self-tapping screws. Screw ball onto lift lever.

CHECKING HYDRAULIC CYLINDER FOR HOLD

1. Lower implement to the shop floor, shut engine off and lock parking brake.
2. Unscrew ball from lift lever.
3. Remove self-tapping screws and lift cover off lift lever to expose the valve.

HYDRAULIC SYSTEM MAINTENANCE

4. Start engine, raise implement and hold lift arm up with overhead hoist to prevent implement from moving down. Shut engine off.

5. Disconnect cylinder hose from 90° fitting on lift valve (Fig. 61). Keep end of hose higher than cylinder to prevent oil from draining out the hose. Plug end of the hose.

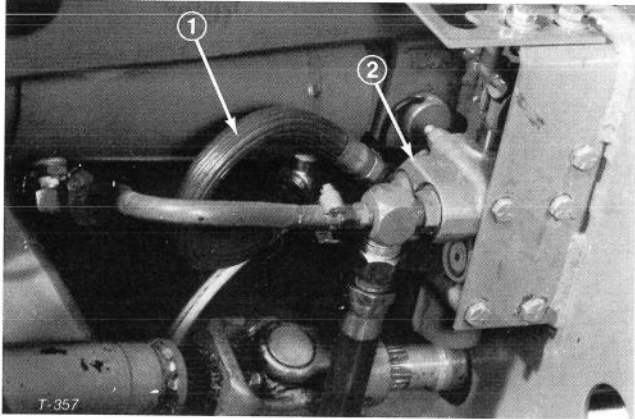

Figure 61

1. Cylinder hose 2. Lift valve

6. Release overhead hoist and watch the lift arm and implement. If implement descends, the cylinder is defective and must be repaired or replaced.

7. Remove plug and connect large cylinder hose to 90° fitting on lift valve.

8. Slide cover into place and install it with self-tapping screws. Screw ball onto lift lever.

REPLACING HYDRAULIC CYLINDER

1. Start engine, lower implement to the shop floor and shut engine off. Jack up right front side of traction unit and support it with jack stand. Remove wheel nuts and slide wheel off mounting studs.

2. Remove hoses from lift cylinder (Fig. 62) and cap the hoses to prevent contamination.

Note: Raise lift arm to extend cylinder and relieve spring tension on lift arm.

3. Remove hair pin cotters and spring from cotter pin. Remove pins and slide cylinder from between the lift arm and the stationary mounting bracket (Fig. 62).

4. Install new cylinder with pins, and assure the cotter pin (Fig. 62) securing moveable end of cylinder is to the outside. Hook chain tension spring through eye of cotter pin.

5. Connect the hydraulic hoses to the lift cylinder.

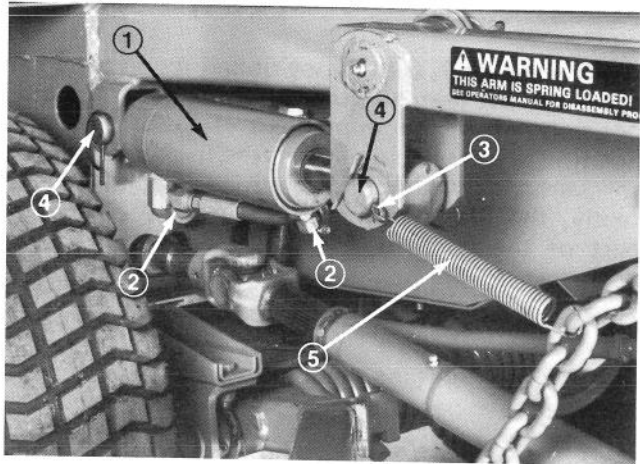

Figure 62

1. Cylinder 4. Mounting pin
2. Hose 5. Spring
3. Cotter pin

6. Install wheel and tighten nuts to 45-50 ft-lb (61-68 N·m). Remove jack stand and lower machine to the shop floor.

7. Check level of hydraulic oil to be sure it is up to ring on dipstick. Then start the engine and operate the lift cylinder to remove air from the lines. Shut engine off.

8. Check level of hydraulic oil again, to be sure it is up to the ring on dipstick.

REPLACING HYDRAULIC OIL FILTER

The hydraulic oil filter keeps the hydraulic system relatively free of contaminants and must be serviced at regular intervals. Initially, change filter after first ten hours of engine operation, and thereafter, after every 250 hours of operation or yearly, whichever comes first. Use TORO oil filter, part no. 23-2300 as a replacement.

1. Clean area where hydraulic oil filter mounts. Remove filter from transmission (Fig. 63) and clean oil filter mounting surface on bottom of transmission.



Figure 63

1. Hydraulic oil filter

HYDRAULIC SYSTEM MAINTENANCE

2. Lubricate gasket on oil filter with SAE 10-W30 or 10W-40 SF oil. Then fill the filter with the same oil.
3. Install filter by hand until gasket contacts mounting head; then an additional 1/2 turn.
4. Start engine and check for hydraulic oil leaks. Allow engine to run for about 2 minutes so any air in the system is purged — removed.
5. Shut engine off and check level of transmission oil; refer to Check Hydraulic System Oil, page 15.
5. Fill new hydraulic oil filter with fresh 10W-30 or 10W-40 oil, and install filter on bottom of transmission.
6. Install tube between axle housing and transmission.
7. Remove dipstick from axle filler tube and fill axle to proper level (Fig. 64). Reinstall the dipstick.

CHANGING HYDRAULIC SYSTEM OIL

The hydraulic system oil must be changed after every 250 hours of operation or yearly, whichever comes first. The axle housing is the reservoir for the hydraulic oil, and its capacity is about 5 U.S. quarts (4.7 L).

1. Start engine, park machine on a level surface, lower implement to shop floor, set the parking brake and shut engine off. Block the two rear wheels.
2. Jack up both sides of front axle and support it with jack stands.
3. Clean area around hydraulic oil filter and remove filter from bottom of transmission.
4. Remove tube that connects axle housing and transmission, and allow oil to flow into drain pan.

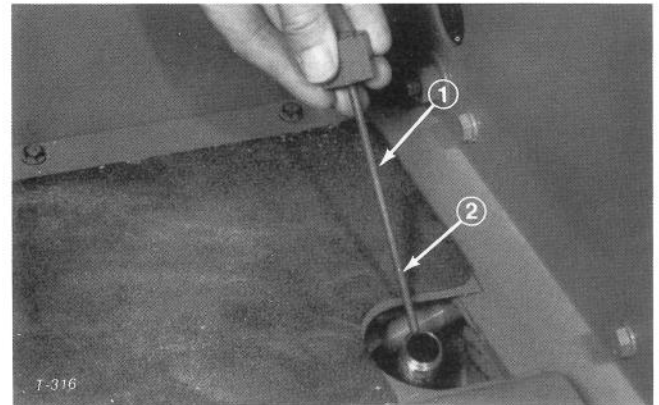

Figure 64

1. Dipstick 2. Groove

8. Start engine and operate the engine at an idle for about 5 minutes. Then shut engine off.
9. Allow machine to set for about 2 minutes. After two minutes, remove dipstick and check level of oil in axle. If level is low, add oil to raise level to groove in dipstick. If level is too high, drain some of the oil until it is at the correct level on the dipstick.

IDENTIFICATION AND ORDERING

MODEL AND SERIAL NUMBERS

The Groundsmaster 327 has two identification numbers; a model number and a serial number. These numbers are stamped into a plate located in front of seat on bulkhead.

In any correspondence concerning the unit, supply the model and serial numbers to assure correct information and replacement parts are obtained.

TORO Distributor, supply the following information:

1. Model and serial numbers.
2. Part number, description and quantity of parts desired.

Note: Do not order by reference number if a parts catalog is being used; use the part number.

PREPARATION FOR SEASONAL STORAGE

Traction Unit

1. Thoroughly clean the traction unit, cutting unit and the engine, paying special attention to these areas:
 - radiator screen
 - underneath the cutting unit
 - under the cutting unit belt covers
 - counterbalance springs
 - P.T.O. Shaft Assembly
 - all grease fittings and pivot points
2. Check the tire pressure. Inflate all traction unit tires to 12 psi (83 kPa).
3. Remove, sharpen and balance the cutting unit's blades. Reinstall the blades and torque the blade fasteners to 75-100 ft-lb (102-136 N·m).
4. Check all fasteners for looseness; tighten as necessary.
5. Grease or oil all grease fittings and pivot points. Wipe off any excess lubricant.
6. Ensure that the P.T.O. lever remains in the disengaged position so that the P.T.O. belt does not take a "set."
7. Lightly sand and use touch up paint on painted areas that are scratched, chipped or rusted. Repair any dents in the metal body.
8. Service the battery and cables as follows:
 - a. Remove the battery terminals from the battery posts.
 - b. Clean the battery, terminals and posts with a wire brush and baking soda solution.
 - c. Coat the cable terminals and battery posts with Grafo 112X skin-over grease (Toro Part Number 505-47), or petroleum jelly to prevent corrosion.

- d. Slowly recharge the battery every 60 days for 24 hours to prevent lead sulfation of the battery.

Engine

1. Drain the engine oil from the oil pan and replace the drain plug.
2. Remove and discard the oil filter. Install a new oil filter.
3. Refill the engine with three quarts (2.8 L) of SAE 10W-30 or 10W-40 motor oil. Use API classification SF oil.
4. Start the engine and run at idle speed for two minutes. **DO NOT RUN LONGER THAN TWO MINUTES.**
5. Stop the engine; remove all spark plugs.
6. Pour one ounce (28cc) of clean engine oil in each spark plug hole.
7. With the ignition coil wire removed, crank the engine with the starter for at least 12 revolutions to distribute the oil in the cylinders.
8. Reinstall the spark plugs. Reconnect the ignition coil wire.
9. Drain the gasoline from the fuel tank, fuel lines, and the carburetor bowl. Reinstall all lines and secure all connections.
10. Thoroughly clean and service the air cleaner assembly.
11. Seal the air cleaner inlet, the exhaust outlet, and the crankcase breather with weather-proof masking tape.
12. Check the oil filler cap, gas cap and radiator cap to ensure they are all securely in place.

SERVICE INTERVAL CHART

Date								
Hour Meter Reading								
Service Interval	↓	Daily	10	50	100	150	200	250
Check Interlock System	Daily							
Check Engine Oil Level	Daily							
Check Transmission Oil Level	Daily							
Check Radiator and Coolant (more often when conditions are dirty)	Daily							
Replace Hydraulic Oil Filter (Initial)	10							
Tighten Front Wheel Nuts (Initial)	2 & 10							
Change Engine Oil	50							
Check Traction Linkage Adj.	50							
Check Governor and Fan Belts	50							
Check Brakes and Lubricate Cables	50							
Check Tire Pressure	50							
Lubricate Grease Fittings	50							
Service Air Cleaner (Dust Cup & Baffle) (more often when conditions are dirty)	50							
Check Battery	50							
Check PTO Drive Belt	50							
Change Engine Oil Filter (more often when conditions are dirty)	100							
Tighten Front Wheel Nuts	250							
Service Air Cleaner (Filter)	250							
Change Transmission Oil and Filter	250							
Check Governor Adj. and Oil	250							
Replace Fuel Filter	250							
Check Rear Wheel Toe-In	250							
Check Points, Condenser and Spark Plugs	250							
Check Engine Timing	250							
Adjust Idle Speed	250							
Adjust Valve Tappets	250							
Tighten Cylinder Head Capscrews	250							
Pack Water Pump Belt Tension Pulley	500							
Pack Rear Wheel Bearings	500							
Replace all Interlock Switches (2 years)	1000							

SERVICE INTERVAL CHART

Date									
Hour Meter Reading									
Service Interval		↓	300	350	400	450	500	550	600
Check Interlock System	Daily								
Check Engine Oil Level	Daily								
Check Transmission Oil Level	Daily								
Check Radiator and Coolant (more often when conditions are dirty)	Daily								
Replace Hydraulic Oil Filter (Initial)	10								
Tighten Front Wheel Nuts (Initial)	2 & 10								
Change Engine Oil	50								
Check Traction Linkage Adj.	50								
Check Governor and Fan Belts	50								
Check Brakes and Lubricate Cables	50								
Check Tire Pressure	50								
Lubricate Grease Fittings	50								
Service Air Cleaner (Dust Cup & Baffle) (more often when conditions are dirty)	50								
Check Battery	50								
Check PTO Drive Belt	50								
Change Engine Oil Filter (more often when conditions are dirty)	100								
Tighten Front Wheel Nuts	250								
Service Air Cleaner (Filter)	250								
Change Transmission Oil and Filter	250								
Check Governor Adj. and Oil	250								
Replace Fuel Filter	250								
Check Rear Wheel Toe-In	250								
Check Points, Condenser and Spark Plugs	250								
Check Engine Timing	250								
Adjust Idle Speed	250								
Adjust Valve Tappets	250								
Tighten Cylinder Head Capscrews	250								
Pack Water Pump Belt Tension Pulley	500								
Pack Rear Wheel Bearings	500								
Replace all Interlock Switches (2 years)	1000								

SERVICE INTERVAL CHART

Date									
Hour Meter Reading									
Service Interval		↓	650	700	750	800	850	900	950
Check Interlock System	Daily								
Check Engine Oil Level	Daily								
Check Transmission Oil Level	Daily								
Check Radiator and Coolant (more often when conditions are dirty)	Daily								
Replace Hydraulic Oil Filter (Initial)	10								
Tighten Front Wheel Nuts (Initial)	2 & 10								
Change Engine Oil	50								
Check Traction Linkage Adj.	50								
Check Governor and Fan Belts	50								
Check Brakes and Lubricate Cables	50								
Check Tire Pressure	50								
Lubricate Grease Fittings	50								
Service Air Cleaner (Dust Cup & Baffle) (more often when conditions are dirty)	50								
Check Battery	50								
Check PTO Drive Belt	50								
Change Engine Oil Filter (more often when conditions are dirty)	100								
Tighten Front Wheel Nuts	250								
Service Air Cleaner (Filter)	250								
Change Transmission Oil and Filter	250								
Check Governor Adj. and Oil	250								
Replace Fuel Filter	250								
Check Rear Wheel Toe-In	250								
Check Points, Condenser and Spark Plugs	250								
Check Engine Timing	250								
Adjust Idle Speed	250								
Adjust Valve Tappets	250								
Tighten Cylinder Head Capscrews	250								
Pack Water Pump Belt Tension Pulley	500								
Pack Rear Wheel Bearings	500								
Replace all Interlock Switches (2 years)	1000								

The Toro Promise

A LIMITED WARRANTY

The Toro Company promises to repair your Model 30787 TORO GROUNDMASTER® MOWER, and its originally purchased cutting unit, if defective in materials or workmanship. The following time periods from the date of purchase apply:

Model 30787 Two Years or 1500 operational hours,
whichever comes first.

The costs of parts, labor and transportation are included.

If you feel your TORO product is defective and wish to rely on The Toro Promise, the following procedure is recommended:

1. Contact your Authorized TORO Distributor or Commercial Dealer (the Yellow Pages of your telephone directory is a good reference source).
2. The TORO Distributor or Commercial Dealer will advise you on the arrangements that can be made to inspect and repair your product.
3. The TORO Distributor or Commercial Dealer will inspect the product and advise you whether the product is defective and, if so, make all repairs necessary to correct the defect without an extra charge to you.

If for any reason you are dissatisfied with the distributor's analysis of the defect or the service performed, you may contact us.

Write:

TORO Commercial Products Service Department
8111 Lyndale Avenue South
Minneapolis, Minnesota 55420

The above remedy of product defects through repair by an Authorized TORO Distributor or Commercial Dealer is the purchaser's sole remedy for any defect.

THERE IS NO OTHER EXPRESS WARRANTY. ALL IMPLIED WARRANTIES OF MERCHANTABILITY AND FITNESS FOR USE ARE LIMITED TO THE DURATION OF THE EXPRESS WARRANTY.

Some states do not allow limitations on how long an implied warranty lasts, so the above limitation may not apply to you.

This Warranty applies only to parts or components which are defective and does not cover repairs necessary due to normal wear, misuse, accidents, or lack of proper maintenance. Regular, routine maintenance of the unit to keep it in proper condition is the responsibility of the owner.

All warranty repairs reimbursable under the Toro Promise must be performed by an Authorized TORO Commercial Dealer or Distributor using Toro approved replacement parts.

Repairs or attempted repairs by anyone other than an Authorized TORO Distributor or Commercial Dealer are not reimbursable under the Toro Promise. In addition, these unauthorized repair attempts may result in additional malfunctions, the correction of which is not covered by warranty. This warranty shall be declared void if the owner removes, disconnects, or in any way alters the operation of the products hour meter.

THE TORO COMPANY IS NOT LIABLE FOR INDIRECT, INCIDENTAL OR CONSEQUENTIAL DAMAGES IN CONNECTION WITH THE USE OF THE PRODUCT INCLUDING ANY COST OR EXPENSE OF PROVIDING SUBSTITUTE EQUIPMENT OR SERVICE DURING PERIODS OF MALFUNCTION OR NON-USE.

Some states do not allow the exclusion or limitation of incidental or consequential damages, so the above limitation or exclusion may not apply to you.

This warranty gives you specific legal rights, and you may also have other rights which vary from state to state.

COUNTRIES OTHER THAN THE UNITED STATES OR CANADA

Customers who have purchased TORO products exported from the United States or Canada should contact their TORO Distributor (Dealer) to obtain guarantee policies for your country, province or state. If for any reason you are

dissatisfied with your Distributor's service or have difficulty obtaining guarantee information, contact the TORO importer. If all other remedies fail, you may contact us at The Toro Company.