

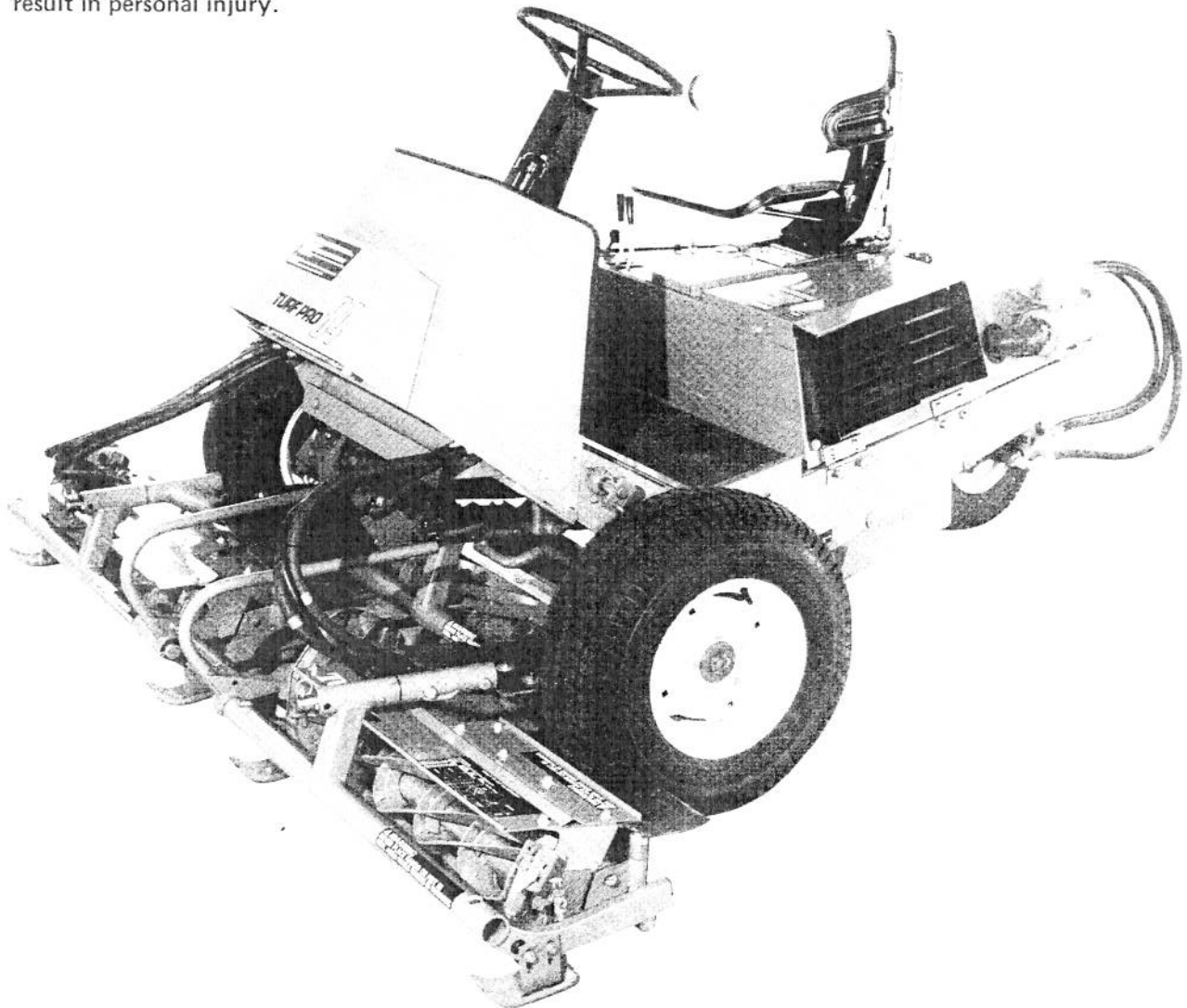

MODEL NO. 03537 — 90001 & UP

**OPERATOR'S
MANUAL****TURF PRO 84® TRACTION UNIT**

To assure maximum safety, optimum performance, and to gain knowledge of the product, it is essential that you or any other operator of the mower read and understand the contents of this manual before the engine is ever started. Pay particular attention to the SAFETY INSTRUCTIONS highlighted by this symbol. The safety alert symbol means CAUTION, WARNING or DANGER — personal safety instruction. Failure to comply with the instruction may result in personal injury.



FOREWORD

Your new TURF PRO 84 was developed to provide an efficient, reliable and time-saving method of mowing high quality turf. The latest concepts in engineering and design have been incorporated into this machine along with the highest quality parts and workmanship. Excellent service will be derived if proper operation and maintenance practices are followed.

We know, since you have purchased the industry leader in mowing excellence, that future performance and dependability are of prime importance. TORO also is concerned about future use of the machine and of safety to the user. Therefore, this manual should be read by you and those involved with the TURF PRO 84 to ensure that safety, proper set-up, operation and maintenance procedures are followed at all times. The major sections of the manual are:

- | | |
|----------------------------------|---------------------------|
| 1. Safety Instructions | 4. Operating Instructions |
| 2. General Assembly Instructions | 5. Maintenance |
| 3. Pre-Operating Instructions | 6. Trouble Shooting |

Safety, mechanical and some general information in this manual is emphasized. DANGER, WARNING and CAUTION identify safety messages. Whenever the triangular safety alert symbol appears,  it is followed by a safety message that must be read and understood. For more complete details concerning safety, read the safety instructions on pages 4, 5 and 6. IMPORTANT identifies special mechanical information and NOTE identifies general information worthy of special attention.

A Kohler engine manual has been included for your reference. Because the Kohler manual is designed to pertain to a variety of engine models, information included does not always specifically apply to the Turf Pro 84. We recommend you refer to the Turf Pro 84 manual for the following:

- | | |
|------------------------|----------------------------|
| Add Engine Oil | Air Cleaner Servicing |
| Starting Instructions | Electrical Schematic |
| Service Interval Chart | Electrical Troubleshooting |
| Carburetor Adjustment | Mechanical Troubleshooting |
| Fuel Pump | |

OPTIONAL SPARK ARRESTER

In some areas there are local, state or federal regulations requiring that a spark arrester be used on the engine of this mower. If a spark arrester is required, order the following parts from your local TORO Distributor:

- (1) 37-7360 Spark Arrester Assembly

These parts are approved by the United States Department of Agriculture and the United States Forest Service.

When mower is used or operated on any California forest, brush or grass covered land, a working order spark arrester must be attached to muffler. If not, the operator is violating state law, Section 442 Public Resources Code.

If help concerning set-up, operation, maintenance or safety is ever needed, contact the local Authorized TORO Distributor. In addition to genuine TORO replacement parts, the distributor also has optional equipment for the complete line of TORO turf care equipment. Keep your Toro all TORO. Buy genuine TORO parts and accessories.

TABLE OF CONTENTS

	Page		Page
SAFETY INSTRUCTIONS	4-5	Disassembly	27
SAFETY AND INSTRUCTION DECALS	6-7	Reassembly	28
LOOSE PARTS CHART	8	Steering Assembly Servicing	28
SPECIFICATIONS	8-9	Repairing Front Counterbalance	29
OPTIONAL EQUIPMENT	9	Repairing Rear Counterbalance	29
GENERAL ASSEMBLY INSTRUCTIONS	10-14	Backlap Operation	30-31
Installing Seat	10	Cutting Unit and Frame Servicing	31
Installing Steering Shaft Bearing	10	Reel Drive Chain Adjustment	32
Installing Steering Wheel	11	Servicing the Rear Roller Assembly	32-33
Remove Machine From Shipping Pallet	11	Air Cleaner Servicing	33-34
Installing No. 2 and 3 Cutting Units and Frame Assemblies	11	Servicing Rear Wheel Spindle Assembly	34-35
Installing Reel Drive Motors to No. 2 and 3 Cutting Units	12	Important Hydraulic Troubleshooting and Test Information	36-61
Installing Tipper Assemblies	12	Servicing the Hydraulic System	62
Initial Cutting Unit Adjustment	12	Draining Reservoir	62
Activate and Charge Battery	13	Hydraulic Filter	62-63
BEFORE OPERATING	14-15	Removing and Replacing Mow/Lift Hydraulic Control Valve	63
Add Engine Oil	14	Repairing Overdrive Selector Valve	63
Filling Gas Tank	15	Removing and Replacing Gear Pump	63
Check Hydraulic System	15	Cutting Unit Gear Pump Servicing	64-65
Level Center Cutting Unit	15	Removing and Replacing Traction and Cutting Unit Pump Assembly	65
Tire Pressure	15	Servicing Tractor Pump Assembly	65
KNOW YOUR CONTROLS	16-18	Charge Pump Assembly Removal and Replacement	66
PRE-OPERATING INSTRUCTIONS	18-19	Servicing Piston Block and Cam Plate Assembly	66
Break-In Period	18	Adjusting Traction Linkage	66
Starting Instructions	18	Removal and Replacement of Rear Wheel Motor	66-67
Check Interlock System for Proper Operation	19	Removal and Replacement of Front Wheel Motor	67
Training Period	19	Front and Rear Wheel Motor Servicing	67-71
OPERATING INSTRUCTIONS	20-22	Removing Cutting Unit Drive Motor	71
Before Mowing	20	Servicing Cutting Unit Drive Motor	72
Operating Characteristics	20	Removing and Replacing Hydraulic Lift Cylinder	73
Mowing Procedures	20	Servicing the Hydraulic Cylinder	73
Transport Operation	20	By-Pass Control Valve Removal Replacement and Adjustment	73
Cutting Unit Bedknife to Reel Adjustment	21	Wiring Harness Service	74
Cutting Unit Skid Adjustment	21	Interlock Switch Testing	74
Inspection and Clean-Up After Mowing	21	Replacing Mow-Backlap Interlock Switch	74
Front Counterbalance Adjustment	21	Traction Interlock Switches	74
Rear Counterbalance Adjustment	22	Seat Interlock Switch	75
Emergency Pushing or Towing Operation	22	ELECTRICAL SCHEMATIC	76
Lubrication and Maintenance	22	ELECTRICAL TROUBLE SHOOTING	77-78
Lubrication Tips	22	MECHANICAL TROUBLE SHOOTING	79
MAINTENANCE	23-75	IDENTIFICATION AND ORDERING	80
Service Interval Chart	23-24	MAINTENANCE RECORD	80-83
Check Engine Oil Pressure	25	THE TORO PROMISE	Back Cover
Carburetor Adjustment	25		
Engine Care	25		
Fuel Pump and Filter	25		
Battery Care and Storage	26		
Battery Removal	26		
Brake Adjustment	26		
Removal of Brake Assembly	27		



SAFETY INSTRUCTIONS

Improper use or maintenance by the operator or owner of the machine can still result in injury. To reduce the potential for any injury, comply with the following safety instructions.

BEFORE OPERATING

1. Operate the machine only after reading and understanding the contents of this manual. A free replacement manual is available by sending complete model and serial number to: The Toro Company, 8111 Lyndale Avenue South, Minneapolis, Minnesota 55420.
2. Never allow children to operate the machine or adults to operate it without proper instructions.
3. Become familiar with the controls and know how to stop the machine and engine quickly.
4. Keep all shields, safety devices and decals in place. If a shield, safety device or decal is defective or damaged, repair or replace it before operating the machine.
5. Always wear substantial shoes. Do not operate machine while wearing sandals, tennis shoes or sneakers. Do not wear loose fitting clothing because it could get caught in moving parts and possibly cause personal injury.
6. Wearing safety glasses, safety shoes, long pants and a helmet is advisable and required by some local ordinances and insurance regulations.
7. Make sure work area is clear of objects which might be picked up and thrown by the reels.
8. Do not carry passengers on the machine, and keep everyone, especially children and pets, away from the areas of operation.
9. Since gasoline is highly flammable, handle it carefully.
 - A. Use an approved gasoline container.
 - B. Do not remove cap from fuel tank when engine is hot or running.
 - C. Do not smoke while handling gasoline.
 - D. Fill fuel tank outdoors and not over one inch (25 mm) from the top of the tank, not the filler neck. Do not overfill.
 - E. Wipe up any spilled gasoline.

WHILE OPERATING

10. Do not run the engine in a confined area without adequate ventilation. Exhaust fumes are hazardous and could be deadly.

11. Sit on the seat when starting and operating the machine.

12. Check the interlock switches daily for proper operation; refer to page 19. If a switch should fail, replace the switch before operating the machine. **(After every two years, replace all four interlock switches in the wiring system, regardless if they are working properly or not.)**

13. To start the engine:

- A. Sit on the seat, verify mow-backlap lever is in OFF position to disengage cutting units.
- B. Verify that transmission is in neutral.
- C. Verify that parking brake is set.
- D. Proceed to start engine.

14. Using the machine demands attention, and to prevent loss of control:

- A. Mow only in daylight or when there is good artificial light.
- B. Watch for holes or other hidden hazards.
- C. Use extreme care when operating close to sand traps, ditches, creeks, steep hillsides or other hazards.
- D. Reduce speed when making sharp turns. Avoid sudden stops and starts.
- E. Before backing up, look to the rear and assure no one is behind the machine.
- F. Watch out for traffic when near or crossing roads. Always yield the right-of-way.
- G. Apply the brakes when going downhill to keep forward speed slow and to maintain control of the machine.

15. Keep hands, feet and clothing away from moving parts and the reel discharge area. If so equipped, the grass baskets must be in place during operation of the reels for maximum safety.

16. Raise the cutting units when driving from one work area to another.

17. Do not touch engine, muffler or exhaust pipe while engine is running or soon after it is stopped because these areas could be hot enough to cause burns.

18. If a cutting unit strikes a solid object or vibrates abnormally, stop immediately, turn engine off, wait for all motion to stop and inspect for damage. A damaged reel or bedknife must be repaired or replaced before operation is continued.



SAFETY INSTRUCTIONS

19. Before getting off the seat:
 - A. Move traction pedal to neutral.
 - B. Set the parking brake.
 - C. Disengage the cutting units and wait for the reels to stop spinning.
 - D. Stop the engine and remove key from ignition switch.
20. Whenever machine is left unattended, make sure reels are not spinning, key is removed from ignition switch and parking brake is set.

MAINTENANCE

21. Before servicing or making adjustments to the machine, stop the engine, remove key from switch and pull high tension wires from ignition coil to prevent accidental starting of the engine.
22. Check performance of all four interlock switches daily. Do not defeat interlock system. It is for your protection.
23. To ensure entire machine is in good operating condition, frequently check and keep all nuts, bolts, screws and hydraulic fittings tight.
24. Make sure all hydraulic line connectors are tight, and all hydraulic hoses and lines are in good condition before applying pressure to the system.
25. Keep body and hands away from pin hole leaks or nozzles that eject hydraulic fluid under high pressure. Use paper or cardboard, not hands, to search for leaks. Hydraulic fluid escaping under pressure can have sufficient force to penetrate skin and do serious damage. If fluid is ejected into the skin it must be surgically removed within a few hours by a doctor familiar with this form of injury or gangrene may result.
26. Before disconnecting or performing any work on the hydraulic system, all pressure in system must be relieved by stopping engine and lowering implement to the ground.
27. If major repairs are ever needed or if assistance is desired, contact an Authorized Toro Distributor. Ask about Mobile Service Maintenance.
28. To reduce potential fire hazard, keep the engine area free of excessive grease, grass, leaves and accumulation of dirt.
29. If the engine must be running to perform a maintenance adjustment, keep hands, feet, clothing, and any other parts of the body away from the cutting units and any moving parts. Keep everyone away.
30. Do not overspeed the engine by changing governor settings. Maximum engine speed (with engine coupled to hydraulic pump) is 3000 ± 100 rpm. To assure safety and accuracy, have an Authorized Toro Distributor check maximum engine speed with a tachometer.
31. Engine must be shut off before checking oil or adding oil to the crankcase.
32. During BACKLAP OPERATION, reels are under power. Contact with reels can result in personal injury.
 - A. Engage parking brake.
 - B. Open bypass valve (page 22).
 - C. Have assistant start engine. Set throttle to minimum idle speed setting and when instructed by mechanic, engage reels in backlap mode.
 - D. Using paint brush attached to extension handle provided, apply lapping compound to reels. **UNDER NO CIRCUMSTANCES USE A SHORT HANDLED PAINT BRUSH.**
33. To insure optimum performance and safety, use genuine TORO replacement parts and accessories. Replacement parts and accessories made by other manufacturers could be dangerous, and such use could void the product warranty of The Toro Company.

SAFETY AND INSTRUCTION DECALS



The following safety and instruction decals are installed on the traction unit. If any become damaged or illegible, replace them. Decals are listed in your Parts Catalog. Order replacements from your Authorized Toro Distributor.

CAUTION

FAILURE TO COMPLY WITH THE FOLLOWING SAFETY INSTRUCTIONS MAY RESULT IN PERSONAL INJURY.

- KEEP PEOPLE AND PETS A SAFE DISTANCE AWAY FROM MACHINE.
- KEEP ALL GUARDS IN PLACE.
- BEFORE LEAVING OPERATOR'S POSITION:
 - MOVE TRANSMISSION TO NEUTRAL.
 - SET PARKING BRAKE.
 - DISENGAGE CUTTING UNIT AND ASSURE REELS ARE NO LONGER SPINNING.
 - SHUT OFF ENGINE.
 - REMOVE IGNITION KEY.
- WAIT FOR ALL MOVEMENT TO STOP BEFORE SERVICING MACHINE.
- STOP ENGINE BEFORE ADDING FUEL OR LIFTING HOOD.
- CHECK PERFORMANCE OF ALL INTERLOCK SWITCHES DAILY. SEE OPERATOR'S MANUAL FOR INSTRUCTION. DO NOT DEFEAT INTERLOCK SYSTEM. IT IS FOR YOUR PROTECTION.

 READ AND UNDERSTAND OPERATOR'S MANUAL BEFORE OPERATING THIS MACHINE. REPLACEMENT MANUAL AVAILABLE BY SENDING COMPLETE MODEL NUMBER TO: THE TORO COMPANY, 8111 LYNDALE AVE., MINNEAPOLIS, MN 55420
17 9700

ON TOP OUTLET COVER (Part No. 39-9700)

CAUTION

Use two wheel drive (transport position) when going down hill to eliminate possible rear wheel slippage resulting in loss of steering and hydraulic braking (shift only when mower is stationary).

Do not park on slopes unless wheels are chocked or blocked.

57-9950

ON CONTROL PANEL (Part No. 57-9950)

IMPORTANT

PLUG HYDRAULIC TANK FILLER NECK WITH PLASTIC CAP NO. 2410-45 BEFORE REMOVING OIL FILTER TO AVOID EXCESSIVE OIL LOSS. SEE OPERATOR'S MANUAL FOR COMPLETE INSTRUCTIONS.

ON CONTROL PANEL (Part No. 29-8940)

DANGER

 NEVER PLACE HANDS OR FEET IN REEL AREA WHILE ENGINE IS RUNNING.

ON CARRIER FRAMES (Part No. 67-7960)

CAUTION

MAINTAIN WHEEL FASTENER TORQUE AT 45-55 ft.-lb. SEE OPERATORS MANUAL FOR INSTRUCTIONS. 67-1720

ON FRAME — BEHIND FRONT WHEELS (Part No. 67-1720)

WARNING

 THIS ARM CAN SPRING UPWARD! SEE OPERATORS MANUAL FOR DISASSEMBLY PROCEDURE

ON CENTER LIFT ARM (Part No. 61-3610)

← CHOKE

OFF

FAST THROTTLE SLOW

MOW OFF BACKLAP

REEL DRIVE

REEL LIFT

DOWN N UP

CUTTING UNIT CONTROLS

START

RUN OFF

OVERDRIVE

UP - HIGH

DOWN - MOW

TO START:

- MOVE REEL DRIVE CONTROL TO OFF
- MOVE TRACTION DRIVE PEDAL TO NEUTRAL POSITION.
- DEPRESS BRAKE PEDAL
- SET CHOKE AND THROTTLE CONTROLS AS REQUIRED (SEE OPERATOR'S MANUAL)
- TURN KEY TO START POSITION

TO STOP:

TURN KEY TO OFF POSITION AND REMOVE KEY

CAUTION

- MOVE REEL DRIVE CONTROL TO OFF BEFORE RAISING CUTTING UNITS.
- DO NOT OPERATE CUTTING UNITS IN RAISED POSITION.

DANGER

BE CAREFUL WHEN BACKLAPPING REELS. CONTACT WITH REEL CAN CAUSE SERIOUS INJURY. SEE OPERATOR'S MANUAL FOR INSTRUCTIONS.

ON CONTROL PANEL (Part No. 36-7520)

SAFETY AND INSTRUCTION DECALS

HEIGHT OF CUT IN	HEIGHT OF CUT CM	BRACKET HOLE	H.O.C. BAR	"H" DIMENSION	"R" DIMENSION
3/8	.95	1	A	3.94 ADJ.	3.53 ADJ.
1/2	1.3	1	A	4.12 ADJ.	3.51
5/8	1.6	2	A	3.94	3.50
3/4	1.9	2	A	3.88 ADJ.	3.88 ADJ.
7/8	2.2	1	C	3.88	3.86
1	2.5	3	A	3.88	3.84
1-1/8	2.8	1	C	3.88	4.35 ADJ.
1-1/4	3.2	3	A	3.88	4.32
1-3/8	3.5	2	C	3.88	4.30
1-1/2	3.8	3	A	3.88	4.84 ADJ.
1-5/8	4.1	2	C	3.88	4.82
1-3/4	4.4	4	A	3.88	4.80
1-7/8	4.8	1	B	3.88	5.21 ADJ.
2	5.1	3	C	3.88	5.19
2 1/8	5.4	2	B	3.88	5.17
2 1/4	5.7	4	C	3.81 ADJ.	5.17
2-3/8	6.0	3	B	3.81	5.15
2-1/2	6.3	5	C	3.81	5.15

HEIGHT OF CUT ADJUSTMENT

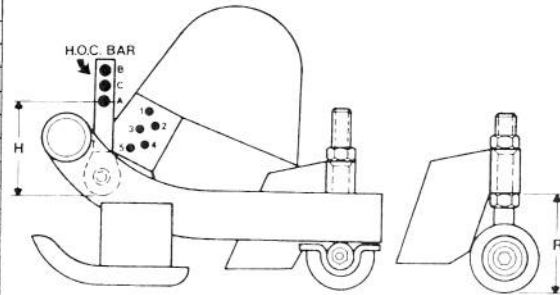

WARNING
TURN ENGINE OFF BEFORE MAKING ADJUSTMENTS.

ON RIGHT FRONT C.U. SHIELD (Part No. 46-7210)

TO LOCK PARKING BRAKE

1. DEPRESS BRAKE PEDAL
 2. DEPRESS LATCH AND RELEASE BRAKE PEDAL
- TO RELEASE PARKING BRAKE
DEPRESS BRAKE PEDAL

PARKING
BRAKE
LATCH



R.H. SIDE OF STEERING TOWER
(Part No. 27-2830)

ON TOP
OUTLET COVER
(Part No.
63-8440)



ON TOP DUCT
(Part No.
62-7290)

TRACTION PEDAL INSTRUCTIONS

THE MORE THE PEDAL IS
DISPLACED, THE FASTER
THE VEHICLE SPEED.

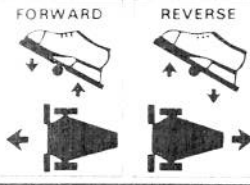

R.H. SIDE OF TRACTION PEDAL
(Part No. 29-2390)

IMPORTANT

RECOMMENDED CYLINDER HEAD
SERVICE INTERVAL IS 250 HOURS
WHEN USING LEADED FUEL. THIS
INTERVAL MAY BE INCREASED IF
UNLEADED FUEL IS USED. SEE
ENGINE MANUAL.

ON TOP DUCT
(Part No. 42-4180)



NEXT TO
HYDRAULIC
RESERVOIR
FILL CAP
(Part No.
53-4430)

CARBURETOR ADJUSTMENT

IMPORTANT

THE MAIN FUEL SCREW WAS ADJUSTED AT THE FACTORY
AND COVERED WITH A CLIP. IT SHOULD NOT HAVE TO BE
RESET.

IF READJUSTMENT BECOMES NECESSARY, TURN MAIN FUEL
SCREW CLOCKWISE UNTIL IT BOTTOMS LIGHTLY, THEN
TURN IT COUNTERCLOCKWISE 4 TURNS. START ENGINE
AND ALLOW IT TO WARM UP, THEN OPERATE AT FULL
THROTTLE. TURN MAIN FUEL ADJUSTMENT CLOCKWISE
UNTIL ENGINE SLOWS DOWN (LEAN SIDE) THEN TURN IT
COUNTERCLOCKWISE 1/2 TURN.

ON TOP DUCT (Part No. 39-1010)

WARNING DURING BACKLAP OPERATION REELS ARE UNDER POWER

CONTACT WITH REELS CAN RESULT IN PERSONAL INJURY.

1. ENGAGE PARKING BRAKE.
2. OPEN BYPASS VALVE.
3. HAVE ASSISTANT START ENGINE AND SET THROTTLE TO MIN. IDLE SPEED SETTING. WHEN INSTRUCTED BY MECHANIC, ENGAGE REELS IN BACKLAP MODE.
4. USING PAINT BRUSH ATTACHED TO HANDLE PROVIDED, APPLY LAPPING COMPOUND TO REELS.

DANGER UNDER NO CIRCUMSTANCES USE
A SHORT HANDLED PAINT BRUSH.
SEE OPERATOR'S MANUAL FOR COMPLETE INSTRUCTIONS.

ON COOLER GUARD
(Part No. 29-9060)

UNLEADED FUEL ONLY

SEE OPERATORS MANUAL
IF UNLEADED FUEL IS NOT AVAILABLE



CAUTION

FILL FUEL TANK TO ONE
INCH BELOW FILLER NECK.
DO NOT OVERFILL.

BY FUEL CAP (Part No. 39-1020)

LOOSE PARTS CHART

LOOSE PARTS	QTY.	DESCRIPTION	WHERE USED
#2 and #3 Cutting Units and Carrier Frame Assemblies	2		Install on Left and Right Hand Push Arms.
Front Pivot Shaft	2		Install on front push arms. Mount cutting unit carrier frames on shafts.
Capscrew	4	1/2-13 x 1-1/4 in. (32mm) lg.	Secures pivot shafts to push arms.
Lockwasher	4	1/2	Install on pivot shaft mounting capscrew.
Thrust Washer	8		Install on pivot shafts and cutting unit tipper bars.
Cotter Pin	4	1/4 x 1-3/4 in. (45mm) lg.	Secures carrier frames to pivot shafts and tippers to frame.
Ball-lok Pin	2		Insert in front pivot shafts.
Tipper Assemblies, R.H. & L.H.	1 ea.		Mount to carrier frames.
O Ring	2		Install between reel drive motor and cutting unit.
Esna Locknut	4	3/8 - 16	Secures reel motors to front cutting units.
Capscrew	2	5/16 - 18 x 2 in.	Secures tipper bar to frame shaft.
Locknut	2	5/16 - 18	Secures tipper bar to frame shaft.
Cap Plug	1		Use while changing hydraulic system oil filter.
Handle and Brush Assembly	1		Use to backlap cutting units.
Tower Cover	1		Use on steering column.
Hex Flange Screw	3	1/4 - 20 x 3/4 in. (19mm) lg.	Use to mount tower cover.
Bearing Support	2		Use to secure steering shaft.
Shim-steering	A/R		Use to mount steering shaft.
Steering Wheel & Cap	1		
Roll Pin	1	1/4 x 2-1/2 in. (64mm) lg.	Use to mount steering wheel.
Adjustment Wrench	1		Use to adjust bedknife to reel.
Operators Manual (Traction)	1		
Operators Manual (Cutting Unit)	1		
Parts Catalog (Traction-Cutting Unit)	1		
Engine Manual	1		
Registration Card	1		Send to The Toro Co. Registers machine.

SPECIFICATIONS

Configuration: Tricycle vehicle with three wheel traction drive and rear wheel steering. Operator sits in center over No. 1 cutting unit with Nos. 2 & 3 cutting units in front of vehicle.

Power: Twin cylinder, air cooled, 4 cycle gasoline engine with 23 H.P. (17.2 kw) @ 3600 rpm output. Equipped with electric starter, 15 amp charging system with 30 amp fuse, cast iron cylinder block with 8 pint (3.78 l) oil capacity and mechanical governor which limits engine speed to 3050 ± 75 rpm.

Drive:

Hydraulic: See hydraulic circuit diagram, page 37.

Traction: All hydraulic drive, consisting of direct drive variable displacement piston pump and 3 geroler wheel motors to drive wheels.

Traction Selector Valve: Single spool, two position selector valve. Valve allows high (two wheel drive) and low range (three wheel drive). High range for transport operation: 0-10 MPH (0-16.1 km/hr) and low range for cutting: 0-5 MPH (0-8 km/hr).

Cutting Units: All hydraulic drive consisting of single section, fixed displacement gear pump, two valve sections and three gear motors which drive the reels. Hydraulic valve is incorporated into reel drive system which will bypass hydraulic oil around reel motors when cutting units are raised with reel drive control in MOW position.

Roller Assembly: Steel pipe roller tube with machined caps. Grease fittings in caps for re-lubricating tapered roller bearings. Roller shaft

SPECIFICATIONS

plated to ease disassembly. Roller assembly mounted by use of moulded rubber bushings. Roller can be levelled to the bedknife by using tapered nuts on the roller rod ends.

Height-of-Cut Adjustment: Pin and hole combination provides quick height-of-cut adjustment. Two adjustment ranges optimize cutting performance. Height-of-cut changed in 1/4 inch (6 mm) increments. Low height ranges from 3/8 inches (10 mm) to 1-1/2 inches (38 mm). High height ranges from 1-1/2 inches (38 mm) to 2-1/2 inches (64 mm). Final height adjustments (matching cutting unit height to one another) are accomplished by using adjustment threads on the H.O.C. adjustment block.

Reel Control Valves: First spool controls cutting unit lift; spool controls reel drive motors.

Operator Safety Features: Engine ignition circuit contains switches which:

- A. Prevents engine cranking for start-up when control lever is in MOW or BACKLAP position.
- B. Prevent engine cranking for start-up when traction pedal is in forward or reverse position.
- C. Shuts engine off if operator leaves seat when control lever is in MOW or BACKLAP position.
- D. Shuts engine off if traction control pedal is accidentally bumped into forward or reverse when machine is unattended.

General Specifications:

Width of Cut:	84 inches (213 cm)
Wheel Tread:	68-1/2 inches (174 cm)
Wheel Base:	51 inches (129 cm)
Overall Length:	98 inches (249 cm)
Overall Width w/cutting units raised	70 inches (178 cm)
Overall Height:	54 inches (137 cm)

Net Weight (Wet): 1650 (748.4 kg)
Shipping Weight Approx. 1850 lb (839.2 kg)

Speeds: (Approx).

Low Range (Cutting) 0-5 MPH (8 km/hr)
High Range (Transport) 0-10 MPH (16.1 km/hr)

Clip: (Approx.)

5 Blade:
0.76 in. (19.4 mm) @ 3 MPH (4.8 km/hr)
1.25 in. (31.8 mm) @ 5 MPH (8 km/hr)

7 Blade:
0.54 in. (13.7 mm) @ 3 MPH (4.8 km/hr)
0.90 in. (22.9 mm) @ 5 MPH (8 km/hr)

Battery: Group U1, 12 Volt, 32 Amp. Hour
Size: Length - 7.75 in. (19.7 cm)
Width - 5.18 in. (13.2 cm)
Height - 6.00 in. (15.2 cm)

Tire Pressure: 10-15 PSI (69-103 kpa) - front and rear.

Brakes: Two 8 in. (20.3 cm) dia. discs w/mechanically actuated calipers with rack and pawl lock for parking.

Hydraulic Filter: 25 micron cartridge type, with large capacity for extra long life.

Hydraulic Oil Reservoir: 4.8 - 5.25 gal. (18.2 - 20 l) capacity with internal baffle to promote cooling. Type fluid: SAE 10W-40 oil.

Gas Tank: 7.5 ga (28.89 l) capacity.

Fuel Pump: Electric, 3 psi pump with replaceable filter, 12 volt DC.

Seat Adjustment: 5 in. (12.7 cm) - forward and rearward.

Controls: Hand operated throttle, choke, lift lever, reel engagement lever and overdrive knob. Foot operated traction pedal and brake.

Electrical & Instrumentation: Engine contains 15 amp alternator, circuit is fused at 30 amps. Instruments include ammeter and hourmeter.

OPTIONAL EQUIPMENT

Suspension and Seat Kit, No. 03542

Roller Scraper Kit, Part No. 49-7400, (7 Blade units).

Basket Kit, No. 03572.

Remote Backlapping Kit, Part No. 36-3060.

Spark Arrester Muffler; refer to page 2.

Optional Height-of-Cut Spacer, Part No. 29-3790.

Front Roller Kit for Floating Carrier Frame, No. 03588 (7 Blade units)

Wheel Weight Kits:

No. 1 - 47 lb (21.3 kg), Part No. 37-4400.

No. 2 - 15 lb (6.8 kg), Part No. 37-4500.

Note: Wheel Weight Kit No. 1 or Calcium Chloride (min. weight of 57 lb - 25.9 kg) must be used to assure unit stability and to meet ANSI B71. 1b-1977 standard with Basket Kit. Basket and Roller Kits combined must use Wheel Weight Kit No. 1 and Calcium Chloride. Both Wheel Weight Kits, No. 1 and 2 or Calcium Chloride must be used with Front Roller Kit.

Blade Kit, No. 03585.

Clip Kit, Part No. 49-2700 (7 Blade units).

GENERAL ASSEMBLY INSTRUCTIONS

INSTALLING SEAT

The Turf Pro 84 is shipped without the seat assembly. Seat Kit, TORO No. 03542 must be installed.

Use the following installation procedure:

SUSPENSION AND SEAT KIT NO. 03542

Tools Required: 7/16 inch, 9/16 inch Wrenches, Quantity of TORO Part No. 505-47 GRAFO (skin-over) Grease.

1. Remove seat, wiring harness and interlock switch from carton.
2. Remove seat support from engine cowl.
3. Separate slide adjustment plate from seat assembly and mount plate to seat support (Fig. 2). Insure heads of mounting capscrews face upwards.
4. Mount seat support to engine cowl, install seat on slide adjustment plate and install interlock wire connector to switch (Fig. 1). Assure mounting capscrew for switch actuating lever is tight and lever is just contacting switch when seat is unoccupied (Fig. 1). Install seat stop bolt into seat support and tighten jam nut (Fig. 2).

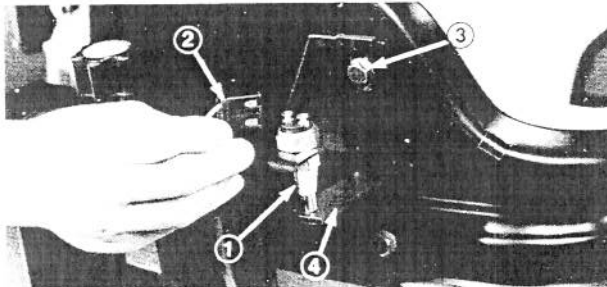

Figure 1

1. Seat switch
2. Wire harness connector
3. Switch actuating lever mounting capscrew
4. Switch actuating lever

5. Fill connector with GRAFO 112X (skin-over) grease, TORO part no. 505-47, connect wiring harness to interlock switch and secure first harness clip with capscrew and nut through the hole in engine cowl at right side of seat base (Fig. 2).

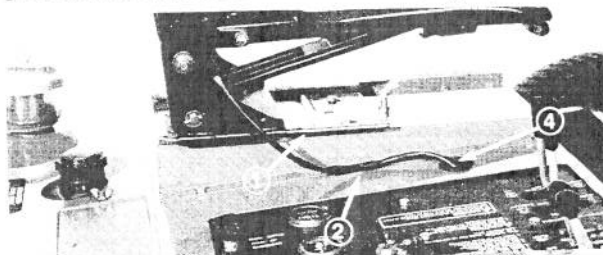

Figure 2

1. Seat slide adjustment plate
2. Wire clip
3. Seat stop bolt and jam nut
4. Grommet

6. Route harness through grommet in engine cowl (Fig. 2), unlatch and raise cowl and secure harness to underside of engine cowl with remaining two (2) wire harness clips (Fig. 3).

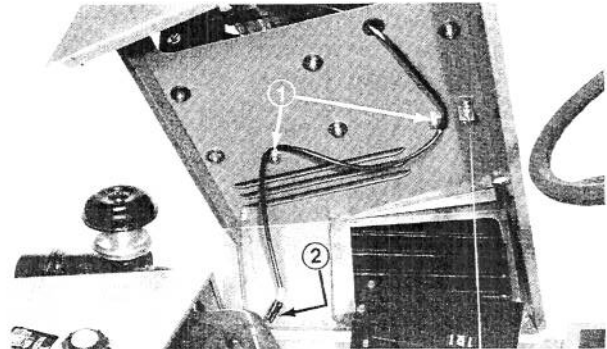

Figure 3

1. Wire clips
2. Connectors

7. Fill the wire connectors with GRAFO 112X (skin-over) grease, TORO Part No. 505-47 and connect the seat switch harness to the main wiring harness (Fig. 3). Close the cowl.

INSTALLING STEERING SHAFT BEARING

Tools Required: 5/16 inch, 1/2 inch Socket Wrench

1. Insure rear wheel is aligned straight fore and aft.
2. Grasp bearing assembly and twist shaft to raise bearing into approximate alignment with mount holes in steering column housing (Fig. 4).

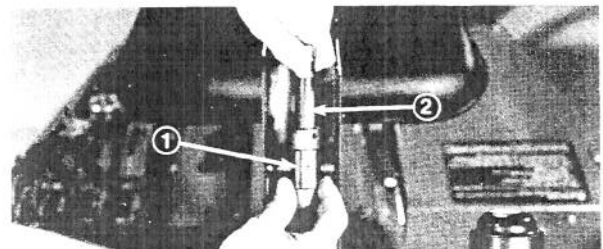

Figure 4

1. Bearing assembly
2. Shaft

3. Move shaft forward to allow clearance, install bearing supports and align support mounting holes with mounting holes in steering column housing (Fig. 7). Insure grease fitting is aligned with large hole in right side of column (Fig. 5).
4. Add shims between bearing supports and steering column (Fig. 6).

Note: Use caution while installing shims so that bearing remains free to rotate on shaft and steering housing is not bowed out making it difficult to install steering column housing cover.

GENERAL ASSEMBLY INSTRUCTIONS

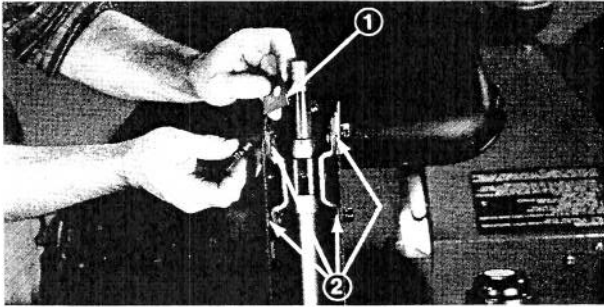

Figure 5

1. Shim 2. Install shims

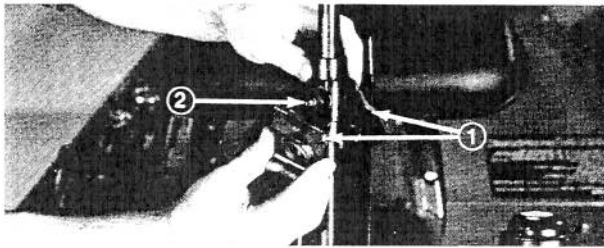

Figure 6

1. Bearing supports 2. Grease fitting

5. Tighten bearing support capscrews and install steering column cover.

INSTALLING STEERING WHEEL

Tools Required: Ball Peen Hammer, Drift Punch.

1. Mount steering wheel over shaft and align holes with a drift punch.
2. Drive the roll pin into steering wheel and shaft (Fig. 7).

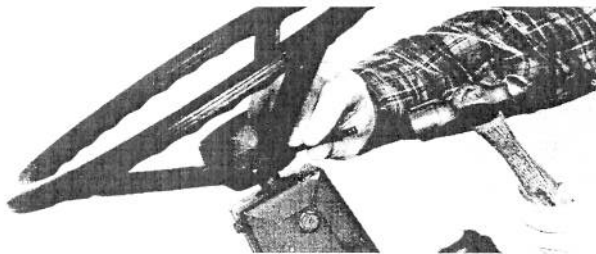

Figure 7



Figure 8

3. Insert the cover plate into the center of the wheel (Fig. 8).

REMOVE MACHINE FROM SHIPPING PALLET

To ease removal of machine from shipping pallet, use the following procedures:

1. Remove banding and supports under rear of unit. Place the supports under the front wheels.
2. Remove fasteners securing reel drive motors to pallet. Place motors in safe location so they will not be damaged when machine is moved.
3. Remove and discard supports securing front axle to base of pallet.
4. Open by-pass valve; refer to Emergency Pushing Operation, page 22.
5. Push machine off the pallet.

INSTALLING NO. 2 AND 3 CUTTING UNITS AND FRAME ASSEMBLIES

Tools Required: 9/16 inch, 3/4 inch Wrench, Pliers.

1. Apply "NEVER SEEZE" to pivot shafts. Insert Front Pivot Shafts into number 2 and 3 push arms, align holes in Pivot Shafts and secure each assembly together with two (2) capscrews and lockwashers (Fig. 9).
2. Install the Carrier Frame and Cutting Unit Assembly to each Pivot Shaft with a Thrust Washer on each side of the carrier frame and install a Cotter Pin to secure the assembly to the shaft (Fig. 9).
3. Insert a Ball-lok Pin into the forward hole of each Pivot Shaft (Fig. 9).

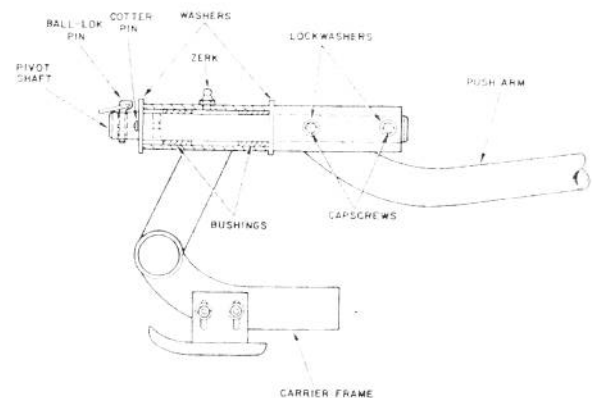

Figure 9

GENERAL ASSEMBLY INSTRUCTIONS

INSTALLING REEL DRIVE MOTORS TO NO. 2 AND 3 CUTTING UNITS.

Tools Required: 3/8 inch, 1/2 inch, 9/16 inch, Socket Wrenches, Torque Wrench.

1. Place cutting units on level surface, set height of cut in highest setting (see H.O.C. adjustment, Fig. 14) and remove inspection cover from chain case cover taking care to prevent damage to the gasket. Loosen idler mounting capscrews (Fig. 10).

2. Remove fill plug and add SAE 90W oil to case until it's level with bottom of fill hole (10-11 oz.) Install fill plug (Fig. 10).

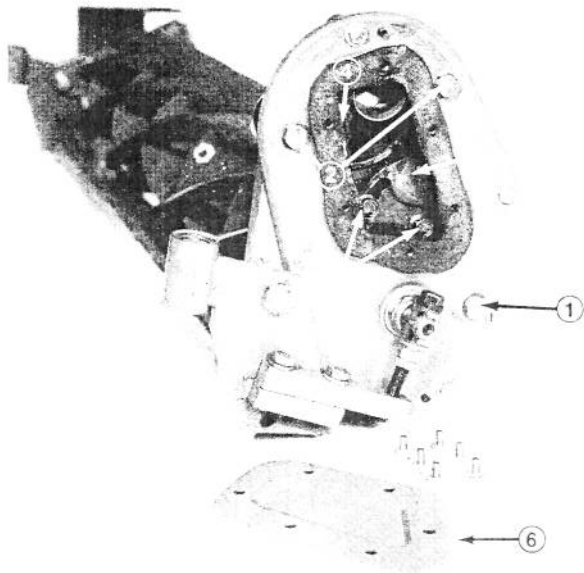

Figure 10

- | | |
|----------------------------------|-----------------------------|
| 1. Fill plug | 4. Drive chain |
| 2. Reel motor mounting capscrews | 5. Idler mounting capscrews |
| 3. Idler assembly | 6. Inspection cover |

3. Remove capscrews, flatwashers and nuts securing top shields (Fig. 11), lubricate the O-rings in clean engine oil and install them on the mounting flange of each reel drive motor.

4. Remove nuts from capscrews securing shipping cover to chain case, remove cover and slide capscrews back until threaded end is flush with motor mounting surface of case (Fig. 10). Discard nuts.

Note: Retain shipping cover. Use whenever reel drive motor is removed to prevent contamination.

Note: Do not allow chain to drop into case.

Note: Do not pull capscrews out of chain case as O-rings on capscrews will be dislodged.

5. Insert reel drive motor into chain case and install drive chain onto the motor sprocket (Fig. 11).

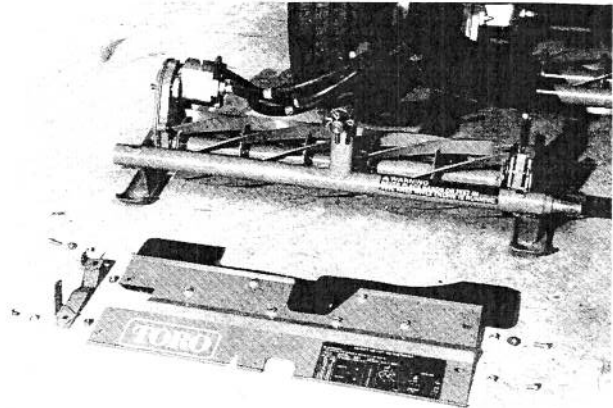

Figure 11

- | | |
|------------------------------------|-----------------------------|
| 1. Capscrews, flatwashers and nuts | 4. Motor mounting capscrews |
| 2. Top shield | 5. Motor flange |
| 3. Reel drive motor | |

6. Push the two (2) reel motor mounting capscrews through motor flange and shield bracket, install locknuts and tighten to secure motor to the case (Fig. 11). Install and tighten shield fasteners.

7. Adjust chain tension to from zero to 1/8 in. (0 - 3 mm) deflection with chain idler assembly (Fig. 10). Chain should not be over tight, but just to point of no deflection. Chain should not exceed 1/4 in. (6 mm) total deflection - 1/8 in. (3 mm) in either direction. Tighten idler capscrew and rotate reel to check tension adjustment. Readjust, if tension is incorrect. Torque idler capscrew to 150-170 in.-lb (17 - 19 N-m) after adjustment is completed.

8. Install inspection cover and gasket. Torque the mounting capscrews to 40-50 in.-lb (45 56 N-m).

INSTALLING TIPPER ASSEMBLIES

Tools Required: 1/2 inch Wrench, Pliers

1. Install large thrust washer, tipper assembly, another washer and cotter pin on frame shaft (Fig. 12).

2. Insert a 5/16-18 x 2" lg. capscrew thru end of tipper bar and secure with a locknut. Tighten locknut only enough to clamp tipper bar in position but allowing tipper bar to be pivoted forward (Fig. 12).

INITIAL CUTTING UNIT ADJUSTMENT

Tools Required: 1-1/8, 3/4, 9/16 in. Wrenches, Scale Ruler.

To obtain best quality of cut at any desired height-of-cut and also achieve proper bedknife attitude at any height-of-cut setting:

GENERAL ASSEMBLY INSTRUCTIONS

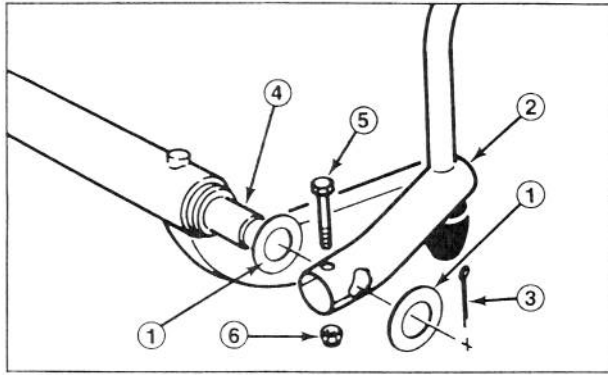

Figure 12

- 1. Thrust washers
- 2. Tipper assembly
- 3. Cotter pin
- 4. Frame shaft
- 5. Capscrew
- 6. Locknut

1. Set cutting units and traction unit on level surface.
2. Adjust tire pressure so the top of frame rail, main frame, is parallel with the ground. Tire pressure should be 10-15 P.S.I. The front tire load radius from ground to center of axle should be 10.88 inches.

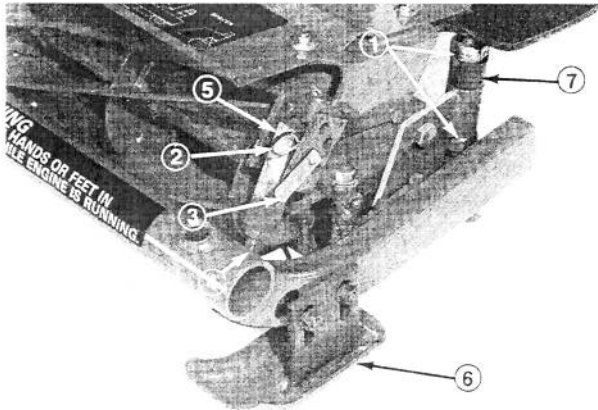

Figure 13

- 1. Taper nut
- 2. Hairpin cotter
- 3. Height-of-cut pin
- 4. Jam nut
- 5. Height-of-cut bar
- 6. Skid
- 7. Height-of-cut spacer (optional)

Note: A height-of-cut spacer, Part No. 29-3790, is available if higher height-of-cut settings are desired. Order from your local Toro Distributor.

3. Determine height-of-cut desired; refer to Fig. 14. Adjust tie rod height-of-cut assembly to proper "H" length. Position height-of-cut pin in the indicated hole. Loosen top taper nuts and adjust lower taper nuts to dimension "R" on both sides of cutting unit.

4. Tighten upper taper nuts and measure height-of-cut at each end of cutting unit. If height-of-cut is not equal at both ends, loosen upper taper on side with lowest measurement and adjust lower

HEIGHT OF CUT	SPACER HOLE	H.O.C. BAR	H. DIMENSION	R. DIMENSION
1.50	1	A	3.94 ADJ	3.93 ADJ
1.50	1	A	4.92 ADJ	3.91
1.50	1	A	3.94	3.90
1.50	2	A	3.88 ADJ	3.88 ADJ
1.50	2	A	3.88	3.86
1.50	3	A	3.80	3.84
1.50	4	C	3.80	4.35 ADJ
1.50	5	A	3.88	4.32
1.50	6	C	3.88	4.30
1.50	7	A	3.88	4.84 ADJ
1.50	8	C	3.88	4.82
1.50	9	A	3.88	4.80
1.50	10	B	3.88	5.21 ADJ
1.50	11	C	3.88	5.19
1.50	12	B	3.88	5.17
1.50	13	C	3.81 ADJ	5.17
1.50	14	C	3.81	5.15
1.50	15	C	3.81	5.13

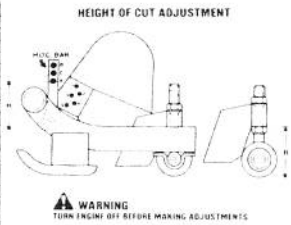

Figure 14

taper nut until both ends of bedknife are at equal height in relationship to the ground surface.

Note: Tighten taper nuts before measuring to assure an accurate measurement.

5. If the measured height-of-cut is not equal to desired setting, readjustment is required, refer to height-of-cut chart, Fig. 14. Loosen the upper taper nuts and adjust the lower taper nuts until the desired height-of-cut is obtained.

6. Level and adjust all cutting units using same procedure. Upon completion check all units to be sure they are set at the same height-of-cut.

7. Intermediate height-of-cut settings may be obtained by following the instructions in the chart (Fig. 14) for bracket hole number and height-of-cut bar hole letter.

Note: The "H" tie rod to H.O.C. bar adjustment and "R" roller adjustment require readjustment and are indicated "ADJ" at the applicable height-of-cut setting.

8. Adjust skids so they are 1/8 - 1/4 in. above the ground surface. This will prevent skid from damaging the turf.

Note: This adjustment may vary depending on turf contour and height-of-cut setting. Lower height-of-cut settings require the skids be positioned closer to the ground surface.

9. Adjust the bedknife to reel; Refer to Cutting Unit Bedknife to Reel Adjustment, page 21.

ACTIVATE AND CHARGE BATTERY

Tools Required: 3 to 4 Amp Battery Charger, Specific Gravity Tester, 7/16 inch, 9/16 inch Wrenches, Screwdriver.

1. Since battery is not filled with electrolyte or activated, bulk electrolyte with 1.260 specific gravity must be purchased from a local battery supply outlet.

2. Lift engine cowl and remove cover over battery (Fig. 15).

IMPORTANT: Do not overfill battery. Electrolyte will overflow onto other parts of the machine and severe corrosion and deterioration will result.

GENERAL ASSEMBLY INSTRUCTIONS



CAUTION

Wear safety goggles and rubber gloves when working with electrolyte. Charge the battery in a well ventilated place so gases produced while charging can dissipate. Since the gases are explosive, keep open flame and electrical spark away from the battery; do not smoke. Nausea may result if the gases are inhaled. Unplug charger from electrical outlet before connecting to or disconnecting charger leads from battery posts.

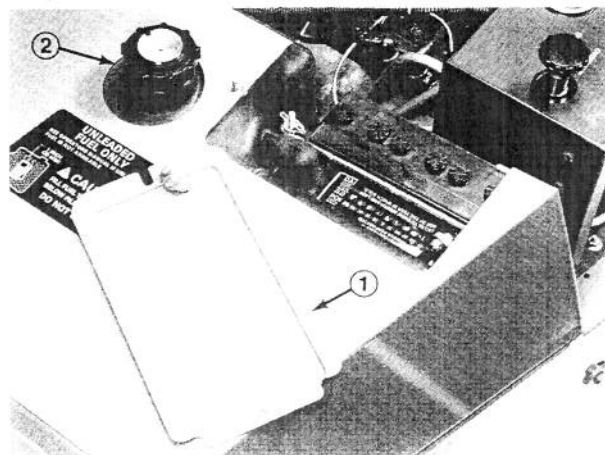

Figure 15

1. Cover 2. Fuel tank cap

3. Remove filler caps from battery and slowly fill each cell until electrolyte is just above the plates. Leave battery set for 20 minutes to obtain best results. Add electrolyte to maximum capacity.

4. Leave filler caps off and connect a 3 to 4 amp battery charger to the battery posts. Charge the battery at a rate of 4 amperes or less for 4 hours.

5. When battery is charged, disconnect charger from electrical outlet and battery posts.

6. Slowly add electrolyte to each cell until level is up to fill ring. Install filler caps.

7. Install the battery into the battery compartment with the terminal posts toward the rear of the machine (Fig. 15).

8. Install the positive cable (rubber boot over end) to the positive (+) terminal and the negative cable (black) to the negative (-) terminal of the battery and secure with capscrews and nuts. Slide the rubber boot over the positive terminal to prevent possible short-out from occurring.

BEFORE OPERATING

ADD ENGINE OIL

1. Place the machine on a level surface.
2. Unlatch and open cowl over the engine.
3. Remove dipstick from the top left side of engine (Fig. 16). Add SAE 30 SC, SE or SF classification engine oil until the oil level in the crankcase is up to the "FULL" mark on the dipstick. Add the oil slowly and check the level often during this process. DO NOT OVERFILL. The crankcase capacity is three and one half (3-1/2) quarts (3.31 L) (Fig. 16).

4. Insure the dipstick is firmly in place.

Note: Refer to engine manual for further recommendations concerning oil specifications, checking intervals and change intervals.

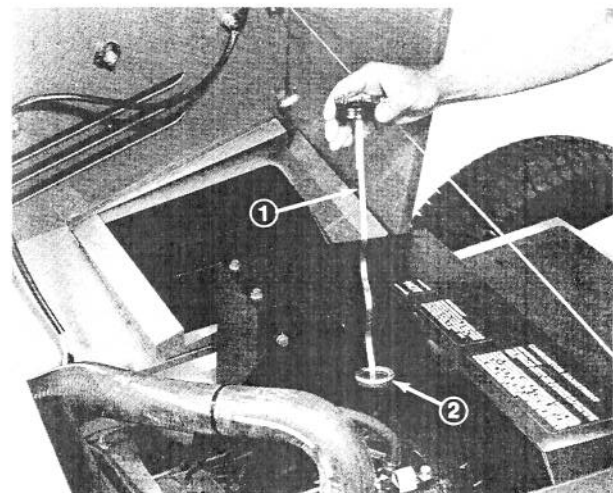

Figure 16

1. Dipstick 2. Oil fill hole

BEFORE OPERATING

FILLING GAS TANK



DANGER

Because gasoline is flammable, caution must be used when storing or handling it. Do not fill fuel tank while engine is running, hot or when machine is in an enclosed area. Vapors may build up and be ignited by a spark or flame source many feet away. **DO NOT SMOKE** while filling the fuel tank to prevent the possibility of an explosion. Always fill fuel tank outside and wipe up any spilled gasoline before starting engine. Use a funnel or spout to prevent spilling gasoline, and fill tank to about 1 inch (25 mm) below the filler neck. Store gasoline in a clean safety-approved container and keep the cap in place on the container. Keep gasoline in a cool, well-ventilated place; never in an enclosed area such as a hot storage shed. To assure volatility, do not buy more than a 30 day supply of gasoline. Gasoline is a fuel for internal combustion engines; therefore, do not use it for any other purpose. Since many children like the smell of gas, keep it out of their reach because the fumes are explosive and dangerous to inhale.

THE TORO COMPANY STRONGLY RECOMMENDS THE USE OF CLEAN, FRESH **UNLEADED** REGULAR GASOLINE IN TORO GASOLINE POWERED PRODUCTS. UNLEADED GASOLINE BURNS CLEANER, EXTENDS ENGINE LIFE, AND PROMOTES GOOD STARTING BY REDUCING THE BUILD-UP OF COMBUSTION CHAMBER DEPOSITS. LEADED GASOLINE CAN BE USED IF UNLEADED IS NOT AVAILABLE.

NOTE: NEVER USE METHANOL, GASOLINE CONTAINING METHANOL, GASOHOL CONTAINING MORE THAN 10% ETHANOL, GASOLINE ADDITIVES, PREMIUM GASOLINE, OR WHITE GAS BECAUSE ENGINE FUEL SYSTEM DAMAGE COULD RESULT.

CHECK HYDRAULIC SYSTEM

1. Remove the cap from the top of the reservoir (Fig. 17) and check the oil level. The oil should be up to the lower hole on the dipstick when the oil is cold and between the holes at operating temperatures. Add SAE 10W-30 or 10W-40 engine oil if the level is low (Fig. 18). Reinstall the cap. Make sure it is firmly in place.
2. Make a close visual inspection of the hydraulic components. Inspect for leaks, loose fasteners,

missing parts, improperly routed lines, etc. Make any corrections necessary. Refer to the Hydraulic

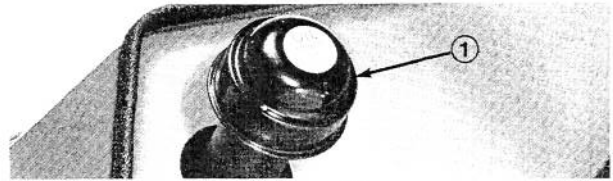

Figure 17

1. Hydraulic oil reservoir cap

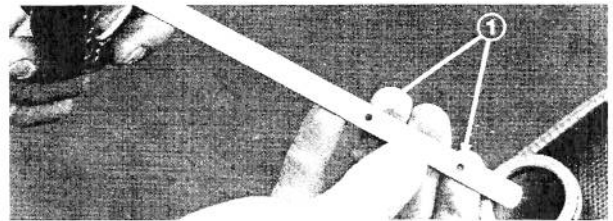

Figure 18

1. Oil level between holes

System Maintenance section, page 62, for further pertinent information.

LEVEL CENTER CUTTING UNIT

Tools Required: 9/16 inch Socket Wrench

The center cutting unit can be adjusted so it will hang level in the transport position.

1. Start engine and raise cutting units to transport position; refer to Starting Instructions, page 18 and Cutting Unit Lift Control, page 17.
2. Stop engine and check center cutting unit position.
3. If cutting unit is not level adjust center plate (Fig. 19). Move plate down if cutting unit is low on right end and up if right end is high.
4. Tighten capscrews securely to hold plate in adjustment (Fig. 19).

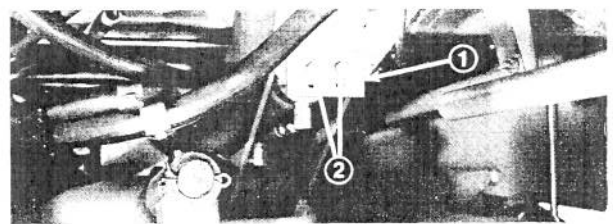

Figure 19

1. Center adjusting plate 2. Capscrews

TIRE PRESSURE

The tires are over-inflated at the factory for shipping purposes. Reduce the pressure to 10 P.S.I. (69 kPa) on the front wheels and 12 P.S.I. (83 kPa) on the rear.

KNOW YOUR CONTROLS

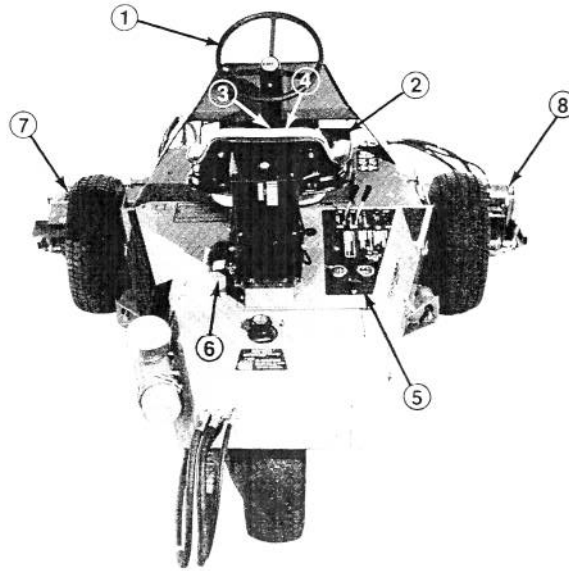

Figure 20

- | | |
|-----------------------|-----------------------------------|
| 1. Steering wheel | 5. Instrument panel (See Fig. 25) |
| 2. Traction pedal | 6. Seat adjustment lever |
| 3. Brake pedal | 7. No. 2 cutting unit |
| 4. Parking brake lock | 8. No. 3 cutting unit |

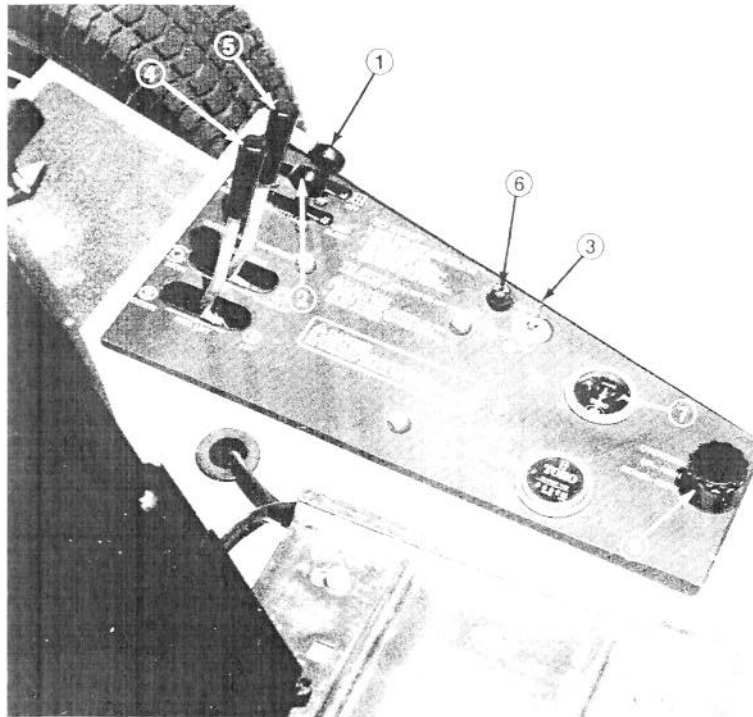

Figure 21

- | | |
|------------------------------|-----------------------|
| 1. Choke control | 6. Fuse holder |
| 2. Throttle control | 7. Ammeter |
| 3. Ignition switch | 8. Hour meter |
| 4. Cutting unit lift control | 9. Overdrive selector |
| 5. Mow-backlap control | |

KNOW YOUR CONTROLS

Suspension Seat – (Fig. 22) – Bucket type seat with armrests on seat back. Lever on left side allows five inch (12.7 mm) fore and aft adjustment. Clamp type knobs allow seat height to be set and maintained at constant setting or re-adjusted for different operators. Knob at rear of seat back controls spring tension adjustment to compensate for weight of operator and insure proper operation of interlock switch (Fig. 22). Aligning white arrows with operator on seat will provide maximum performance and comfort.

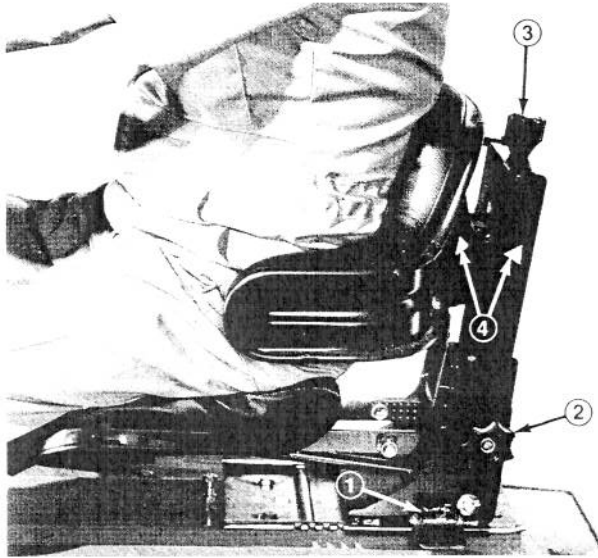

Figure 22

1. Fore and aft adjustment lever
2. Height adjustment clamp knob
3. Seat tension adjustment knob
4. White arrows

Traction Pedal (Fig. 20) – Traction pedal has two functions; one to make the machine move forward, the other to move it backward. Using the heel and toe of the right foot, depress the top of pedal to move forward and bottom of pedal to move backward. Ground speed is proportionate to how far pedal is depressed. For maximum ground speed with no load, traction pedal must be fully depressed while throttle is in FAST position. Maximum speed forward is approximately 10 mph (16 km/hr). To get maximum power under heavy load or when ascending a hill, have throttle in FAST position while depressing traction pedal slightly to keep engine rpm high. When engine rpm begins to decrease, release traction pedal slightly to allow engine rpm to increase.

Overdrive Selector (Fig. 21) – Black knob at rear of instrument panel. Push knob to DOWN (mow) position to provide drive to all three (3) wheels and ground speed of approximately 0-5 MPH (0-8 km/hr) for mowing operation. Pull knob to UP

(transport) position to provide drive to two (2) front wheels and ground speed of approximately 0-10 MPH (0-16 km/hr) for transport operation.

IMPORTANT: Overdrive selector must be shifted when mower is stationary.

Brake Pedal (Fig. 20) – Brake pedal actuates 8 in. (20.3 cm) diameter caliper type mechanical disc brake assemblies on each front wheel.

Parking Brake Button (Fig. 20) – Depressing the Brake Pedal to actuate the brake assembly, then depressing the small button indicated will keep the brakes actuated for parking. Disengage by depressing the brake pedal. Whenever the engine is shut off, the parking brake must be engaged to prevent accidental movement of the machine.



WARNING

The hydrostatic transmission will not, at anytime, act as a parking brake for the machine.

Mow-Backlap Control (Fig. 21) – Outboard hydraulic control lever. Has three positions, MOW, OFF and BACKLAP. Move lever fully forward to detent for MOW operation, to center of slot to OFF position to stop reels and to full rearward detent position to BACKLAP for backlapping operation or to clear reels of foreign materials.



CAUTION

Do not actuate this control unless cutting units are fully down as the exposed, rotating blades are hazardous.

Cutting Unit Lift Control (Fig. 21) – Inboard hydraulic control lever. Has three positions, DOWN, NEUTRAL and UP. Move lever fully forward to DOWN position and hold for approximately five to ten seconds to fully lower cutting units and ensure they will follow uneven ground contours. Release lever to allow it to return to NEUTRAL position. Pull lever rearward and hold in UP position to fully raise cutting units.



CAUTION

Do not raise cutting units while blades are rotating. The exposed, rotating blades are hazardous.

KNOW YOUR CONTROLS

Throttle (Fig. 21) – Throttle is used to adjust engine to various speeds. Moving throttle forward increases engine speed – FAST; backward decreases engine speed – SLOW. The throttle regulates the speed of the cutter blades and, in conjunction with traction pedal, controls ground speed of the traction unit.

Choke (Fig. 21) – To start a cold engine, close carburetor choke by moving choke control fully forward. After engine starts, regulate choke to keep engine running smoothly. As soon as possible, open the choke by pulling lever backward.

Ignition Switch (Fig. 21) – The ignition switch, which is used to start and stop the engine, has three positions: OFF, RUN and START. Rotate key clockwise to the START position to engage starter motor. When engine starts, release key and it will move automatically to the ON position. To shut engine off, rotate key counterclockwise to the OFF position.

Fuse Holder (Fig. 21) – Located in front of hour-meter. Fuse Holder is part of charging circuit and contains a 30 Amp fuse. Remove fuse by rotating

knob of Fuse Holder counterclockwise. Knob will come free of detent slot and can be removed and fuse can be extracted. Reinstall by inserting the fuse and placing knob over the fuse. Push down and rotate the knob clockwise until it locks in the detent slot.

Hour Meter (Fig. 21) – Located in front of over-drive selector. Indicates the total hours of machine operation. The Hour Meter starts to function whenever the key switch is rotated to “ON”.

Note: Lines moving in the small window at the left side of the Hour Meter face indicates the Hour Meter is functioning.

Ammeter (Fig. 21) – Located above Hour Meter. Ammeter shows charge rate of battery by the generator. When engine is running, there usually is a slight charge, unless engine is idling slowly. Needle will point to 0 when battery is fully charged. By contrast, generator is not charging battery when needle points to (–) negative side of ammeter, and if this happens, repair charging system to prevent discharge of the battery.

PRE-OPERATING INSTRUCTIONS

BREAK-IN PERIOD

1. Refer to the Engine Manual supplied with the Turf Pro 84 for oil change and maintenance procedures recommended during break-in period.
2. Only 8 hours of mowing operation is required for the Turf Pro 84 break-in period.
3. Since the first hours of operation are critical to insuring future dependability of the machine, monitor its functions and performance closely so that minor difficulties, which could lead to future major problems, are noted and can be corrected. Inspect the Turf Pro 84 frequently during break-in for signs of oil leakage, loose fasteners, or any other malfunction.

STARTING INSTRUCTIONS

1. Sit on seat, place Traction Pedal in “Neutral” position, check Mow and Lift Levers to be sure they are also in neutral position.
2. Move choke lever to ON and move throttle control to 1/3 position.
3. Insert and rotate ignition key clockwise until the engine starts. Move choke lever halfway back when engine starts and keep moving back as engine warms until it is fully OFF and engine is at normal operating temperature.

4. Check the machine out with the following procedures after the engine has started:

Note: Insure areas beneath mowers are clear of debris.

- A. Move throttle control to FAST position, move Reel-Lift lever to DOWN position and hold until engine speed drops slightly and noise level increases, indicating hydraulic system relief valve is open relieving high pressure and cutting units are fully down. Release lever and momentarily check reel operation by moving Mow-Backlap lever to MOW and BACKLAP positions. Reels should spin freely and emit a whispering sound.
- B. Move Mow-Backlap lever to OFF position. Cutting reels should stop. Move Reel-Lift lever to UP. Cutting units should raise to full transport position.
- C. Depress the brake pedal to stabilize the machine and move the traction pedal through the forward and reverse positions.
- D. Continue the above procedure for 1-2 minutes; neutralize the traction pedal and mow and lift levers, lock the parking brake, and turn the engine off. Check for oil leaks; if oil leaks appear, check tightness of hydraulic fittings. If oil leaks continue to appear, contact your local TORO Distributor for assistance and, if necessary, replacement parts.

PRE-OPERATING INSTRUCTIONS

IMPORTANT: Motor or wheel seals may show some trace of oil for a short period of time until the Turf Pro 84 break-in period has transpired.

Note: Since the Turf Pro 84 is brand-new and the bearings and reels are tight, it is necessary to use the FAST throttle control position for this check. A fast throttle setting may not be required after the break-in period.

IF COMPONENTS FAIL TO FUNCTION PROPERLY, refer to Trouble Shooting section, page 77-80.

CHECK INTERLOCK SYSTEM FOR PROPER OPERATION

Perform the following system checks daily in an open area free of bystanders to assure the interlock system is operating correctly.

1. Sit on the seat, engage parking brake and depress traction pedal into forward and reverse positions while trying to start the engine in each position. The engine should not crank, which means traction switches are operating correctly. If engine did not crank, proceed to step 2. If engine cranked, refer to Trouble Shooting, page 77.

2. Sit on the seat, engage parking brake, move Mow-Backlap lever to MOW and BACKLAP positions and try to start the engine. The engine should not crank, which means mow-backlap switches are operating correctly. If engine did not crank, proceed to step 3. If engine cranked, refer to Trouble Shooting, page 77.

3. Sit on the seat, engage parking brake, insure Mow-Backlap lever is in OFF and Traction Pedal is in neutral and try to start engine. The engine should start and continue to run which means the switches are operating correctly. Proceed to step 4. If engine cranked, but did not start, problem is not in the interlock system. If the engine did not crank, refer to Trouble Shooting, page 77.

4. Sit on the seat, start engine and move lift lever to UP to raise cutting units. Drive to an open area that is free of debris and foreign objects. Ensure all bystanders are kept away from front of machine and that they are not in the area of operation. Engage parking brake, set throttle control at half speed and move lift lever to DOWN to lower cutting units.

A. Move Mow-Backlap lever to MOW position. Carefully lift off the seat; the engine should stop. If engine stops, interlock system is operating correctly. Proceed to step B. If engine does not stop, stop the engine and find the problem before operating machine again; refer to Trouble Shooting, page 77.

B. Move Mow-Backlap Lever to BACKLAP position. Carefully lift off the seat. The engine should stop. If engine stops, interlock system is operating correctly. Proceed to step C. If engine does not stop, move the lever to OFF, stop the engine and find the problem before operating machine again; refer to Trouble Shooting, page 77.

C. Slowly actuate Traction Pedal forward and carefully lift off seat. The engine should stop. If engine stops, interlock system is operating correctly. Proceed to step D. If engine does not stop, stop engine and find the problem before operating machine again; refer to Trouble Shooting, page 77.

D. Slowly actuate Traction Pedal in reverse and carefully lift off seat. The engine should stop. If engine stops, interlock system is operating correctly and machine can be normally operated. If engine does not stop, stop engine and find the problem before operating machine again; refer to Trouble Shooting, page 77.



CAUTION

Do not disconnect the interlock switches because they are for the operator's protection. Check operation of the switches daily to assure the interlock system is operating correctly. If a switch is defective, replace it before operating the machine. Replace the switches every two years to ensure maximum safety regardless of whether they are working properly or not.

TRAINING PERIOD

Before mowing with the Turf Pro 84, The Toro Company suggests that you find a clear area and practice starting and stopping, raising and lowering mowers, turning, etc. This training period will be beneficial to the operator in gaining confidence in the performance of the Turf Pro 84.

IMPORTANT: If overdrive control is shifted from MOW to HIGH position while vehicle is in motion, a sudden increase in ground speed will result. For safety purposes, it is recommended that overdrive selector positions not be changed while vehicle is in motion. To prevent damage to cutting units and carrier frame assemblies, mow with the selector knob down in the MOW position only.

OPERATING INSTRUCTIONS

BEFORE MOWING

Inspect the area for debris and clear area if necessary. Determine the direction best to mow. Base the direction to mow on the previous mowing direction. Always mow in an alternate pattern from the previous mowing, so that the grass blades will be less apt to lay down and therefore be difficult to gather between the reel blades and bedknife.

OPERATING CHARACTERISTICS

Practice driving the Turf Pro 84 because it has a hydrostatic transmission and its characteristics are different than many turf maintenance machines. Some points to consider when operating the traction unit and cutting units are the transmission, engine speed, load on the cutting units, and the importance of the brakes.

To maintain enough power for the traction unit and cutting units while mowing, regulate traction pedal to keep engine rpm high and somewhat constant. A good rule to follow is; decrease ground speed as the load on the cutting blades increases, and increase ground speed as load on the blades decreases. This allows the engine, working with the transmission, to sense the proper ground speed while maintaining high reel speed, necessary for good quality-of-cut. Therefore, allow traction pedal to move backward as engine rpm decreases, and depress pedal slowly as rpm increases. By comparison, when driving from one work area to another — with no load and cutting units raised — have throttle in FAST position and selector knob in HIGH position. Depress traction pedal slowly but fully to attain maximum ground speed.

When backing up or descending steep grades, shift the Overdrive Selector to HIGH. The maximum recommended incline is 30°.

MOWING PROCEDURES

Approach the area to mow with the overdrive selector knob pushed down to the MOW position. Move the Reel Lift lever to DOWN to drop cutting units to turf. Hold the lever in position for 5-10 seconds after cutting units are down to assure cylinder rods are fully extended so that cutting unit reels will turn when Mow-Backlap lever is engaged and cutting units will follow all turf contours. Release Reel Lift lever and push Mow-Backlap lever to MOW detent position to start reels in operation. If mower reels do not operate when Mow-Backlap lever is positioned in MOW:

- A. Return Mow-Backlap lever to OFF position.
- B. Move Reel Lift lever to DOWN and hold until cylinder rods are fully extended.

- C. Release Reel Lift lever and push Mow-Backlap lever to MOW position to start reels.

At completion of mowing operation, move Mow-Backlap lever to OFF position to stop reels and hold Reel-Lift lever in UP position to raise cutting units. Hold lever in position until hydraulic system emits a squealing sound indicating a hydraulic relief valve has opened. Release lever.

TRANSPORT OPERATION

Insure the cutting units are in full up position, pull the Overdrive Selector Knob to the UP-HIGH position to achieve high speed traction operation.

Operate at slower ground speeds in rough or hilly areas. Use the brakes to slow the machine while going down slopes to avoid loss of control. Always approach rough areas at a reduced speed (overdrive selector in MOW), and cross severe undulations carefully. Familiarize yourself with the width of the Turf Pro 84. Do not attempt to pass between objects that are close together so that costly damage and downtime can be prevented.

Note: The two front cutting units can be raised from a 45° angle to 90° to allow the Turf Pro 84 to pass through a confined area (Fig. 23). Stop engine and push the cutting units up to a 90° position, align the hole in the side of the carrier frame with the inner pivot shaft hole and insert the Ball-lok Pin from the front pivot shaft hole to secure the unit upright (Fig. 24).

Note: If engine stops during mowing or transport operation for no apparent reason; i.e., lack of fuel, etc., refer to Electrical Troubleshooting, page 77 and Mechanical Troubleshooting, page 79-80. DO NOT ATTEMPT TO RESTART ENGINE AND OPERATE MACHINE or internal engine damage could occur.

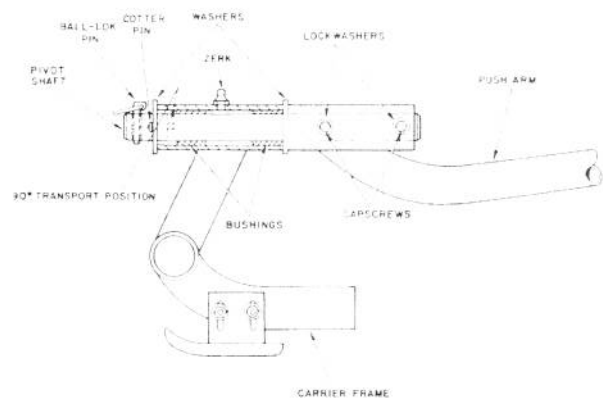

Figure 23

OPERATING INSTRUCTIONS

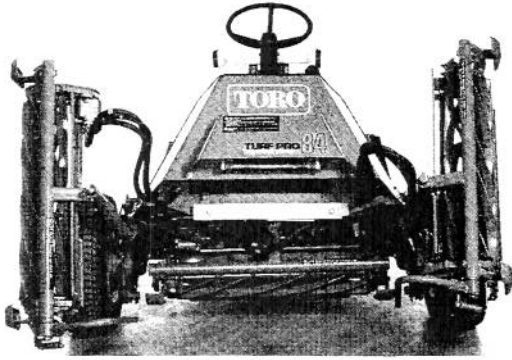
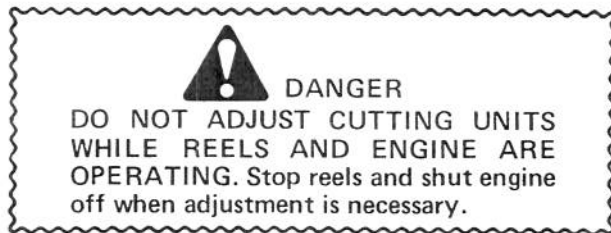

Figure 24



CUTTING UNIT BEDKNIFE TO REEL ADJUSTMENT

Check bedknife to reel adjustments at least twice daily; prior to beginning mowing operation in the morning and again at mid-day.

1. Lower cutting units, place controls in neutral position, set parking brake and turn engine off.
2. Rotate reel, engage Reel Adjustment Wrench, Part No. 42-3330, (Fig. 26) with Reel Adjusting Screws (Fig. 25) and adjust both ends of bedknife so they are in light contact with reel blades. Reel should rotate freely after adjustment. High spots



Figure 25

1. Reel adjustment screw

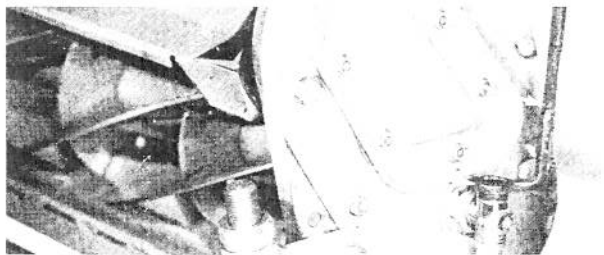

Figure 26

1. Reel adjustment wrench
2. 1/6 turn - either direction - moves bedknife approx. 0.003 in. (0.076 mm)

on reel blades and/or bedknife caused by damage should be removed with a file before commencing operation.

Note: A light contact adjustment between reel and bedknife will produce best cutting results. If units are adjusted at proper intervals only a minute adjustment will be required. Use the points in the Adjusting Wrench as index points so adjustments can be made in small increments. One sixth turn in either direction moves the bedknife approximately .003 inch (0.076 mm) toward or away from reel (Fig. 26).

CUTTING UNIT SKID ADJUSTMENT

Under most cutting conditions, skids should be left down to achieve best performance from the cutting units; refer to Initial Cutting Unit Adjustment, step 8, page 12-13. Adjust skids upward only if skids are marking or otherwise damaging the turf.

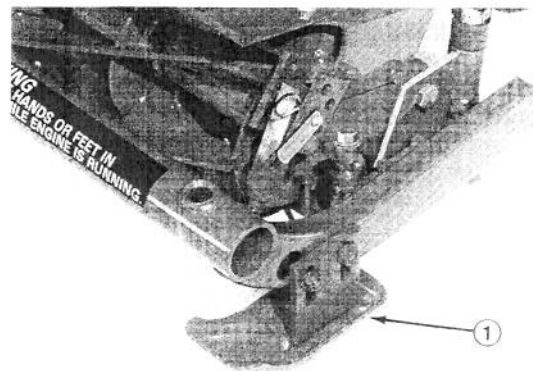

Figure 27

1. Skid

INSPECTION AND CLEAN-UP AFTER MOWING

At the completion of mowing operation, thoroughly wash the machine with a garden hose **without** a nozzle so excessive water pressure will not cause contamination and damage to seals and bearings. After cleaning, it is recommended the machine be inspected for possible hydraulic fluid leaks, damage or wear to hydraulic and mechanical components and the cutting units checked for sharpness.

FRONT COUNTERBALANCE ADJUSTMENT

Tools Required: 1 1/8 inch Wrench, Tape Measure.

Under normal operating conditions, front counterbalance need never be adjusted. However, adjustment may be necessary if turf is sparse and extremely wet, causing the drive wheels to lose traction. Decrease the downward force on the front cutting units with the following procedures:

1. Raise cutting units to transport position and

OPERATING INSTRUCTIONS

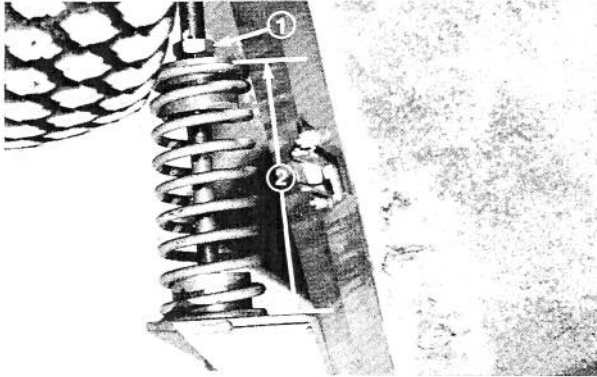

Figure 28

1. Jam nuts
2. $6\frac{1}{2} \pm \frac{1}{4}$ inches (16.5 cm \pm 6 mm)

loosen jam nuts on the transfer rods for each assembly (Fig. 28).

2. Turn the nuts on the transfer rods clockwise to compress the springs.

Note: Preliminary spring setting is approximately $6\frac{1}{2} \pm \frac{1}{4}$ inches (16.5 cm \pm 6 mm).

3. Adjust in small increments and test operate the machine. Measure each spring's length with a tape measure to assure equal adjustment on both sides of unit.

4. Adjust until wheels are no longer slipping.

5. Tighten jam nuts to secure adjustment.

REAR COUNTERBALANCE ADJUSTMENT

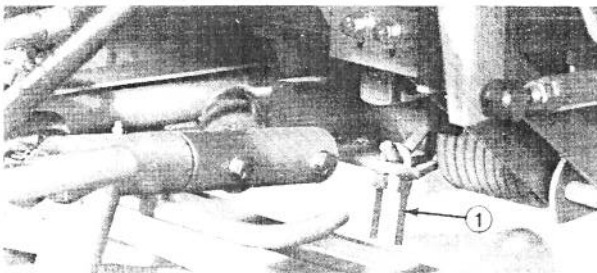

Figure 29

1. U-bolt

Tools Required: 9/16 inch Deep Wall Socket and Wrench, 9/16 inch Open End Wrench.

Adjust the rear counterbalance if there is evidence that the No. 1 (center) cutting unit is cutting higher than the front cutting units.

1. Loosen the two (2) nuts securing the two (2) flange locknuts to the U-bolt (Fig. 29).

2. Back the nuts off to decrease spring tension against the center push arm.

3. Adjust in small increments and test operate unit.

4. Secure flange locknuts with nuts to maintain adjustment.

EMERGENCY PUSHING OR TOWING OPERATION

The Turf Pro 84 can be moved by pushing or towing if the engine becomes inoperative.

1. Unlatch and lift the cowl over the engine and unlatch and remove the floor plate.

2. Locate the By-Pass Valve on the top of the pump and open the valve by turning it so that wrench flats on valve stem are facing toward the front and rear of the machine (Fig. 30).

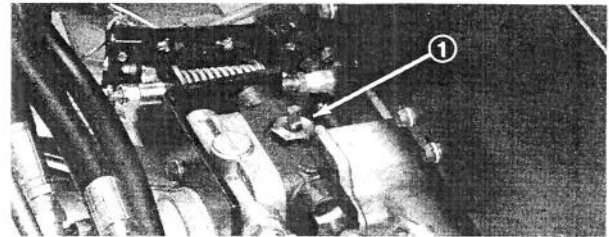

Figure 30

1. By-pass valve

3. Lower cowl and commence pushing or towing operation.

Note: Do not exceed 3 MPH (4.8 km/hr) ground speed or serious damage will be caused to the internal parts of the hydraulic system.

4. Open cowl, close valve by turning valve stem until flats face toward the sides of the machine, install floor plate and close cowl upon completion of pushing operation.

LUBRICATION AND MAINTENANCE

The areas to lubricate are pictured and a Service Interval Chart to assist in maintaining your Turf Pro 84 is provided. The service intervals listed apply to machines used in normal operating conditions. A Turf Pro 84 used in more severe conditions should be serviced more frequently.

LUBRICATION TIPS

1. To assure adequate lubrication, turn the steering wheel fully to the left before greasing the lower portion of the steering shaft. Apply grease until it starts to come out spring mounting hole on upper portion of lower steering sleeve.

2. Apply three to four strokes with the grease gun handle while greasing the cutting unit reels and rear rollers.

MAINTENANCE

SERVICE INTERVAL CHART

Location	Service Part	No. of Fittings	Frequency of Service	Type of Lubricant
Pivots, Joints & Bearings	Front Cutting Unit Pivots 5 Blade (Fig. 31)	3	Every 50 hours. More frequently in severe conditions	#2 Multi-Purpose Lithium Base Grease
	Front Cutting Unit Pivots 7 Blade (Fig. 31)	6		
	Counterbalance Arms (Fig. 32)	2		
	Front & Rear Push Arm Pivots (Fig. 31)	3		
	Upper & Lower Steering Assy. (Fig. 33, 34)	2		
	Steering Transfer Tube (Fig. 34)	1	Every 250 hours. Every 250 hours.	
	Traction Pedal (Fig. 35)	1		
	Brake Support Bearings (Fig. 36)	2		
	Cutting Unit Roller Bearings (Fig. 37)	6		
	Cutting Unit Reel Bearings (Fig. 31)	3		
Rear Wheel Spindle Bearings (Fig. 64)	1	Every 250 hours.		
Cutting Unit Chain Case		Every 100 hours initially. Every 500 hours after chain tension & oil level have stabilized.	SAE 90W Oil. Refer to Cutting Unit Operator's Manual.	
Engine	Oil Fill & Dipstick (Fig. 38) Oil Drain (Fig. 39) Oil Filter (Fig. 40) under cowl R.H. side		Check daily. Every 50 hours. Replace every 100 hours.	Refer to Engine Manual supplied with Turf Pro 84 for maintenance requirements.
	Air Cleaner (Fig. 41)		Check bowl weekly; daily in extremely dirty conditions. Check filter element monthly. (Refer to pg. 33).	
Hydraulic System	Oil Level (Fig. 42) Oil Change (refer to Draining Reservoir, pg. 62) Oil Filter Replacement (Fig. 40)		Check weekly Every 2000 hrs. After first 10 hrs. Every 250 hrs thereafter.	Use 10W 30 or 10W-40 Engine Oil, SC, SE or SF classification
Interlock Switches	Seat switch (Suspension Seat) Mow-Backlap Switch Forward-Reverse Switches		Check daily. Replace every 2 years or when malfunction occurs.	

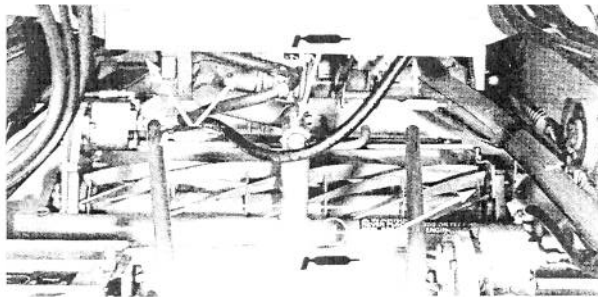

Figure 31

1. Reel bearings — one each cutting unit

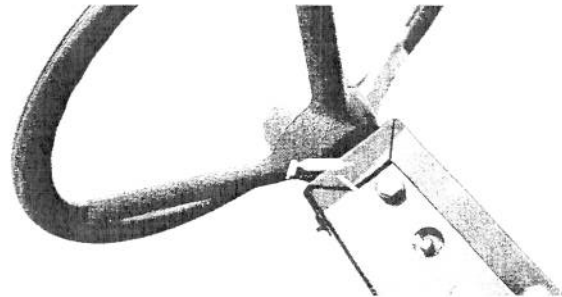

Figure 33

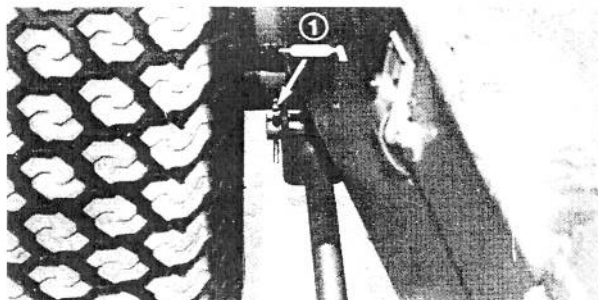

Figure 32

1. Two fittings — one on each side

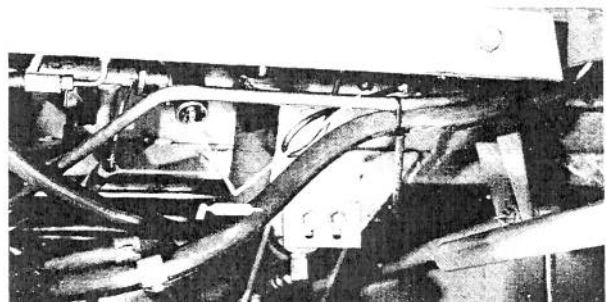

Figure 34

MAINTENANCE

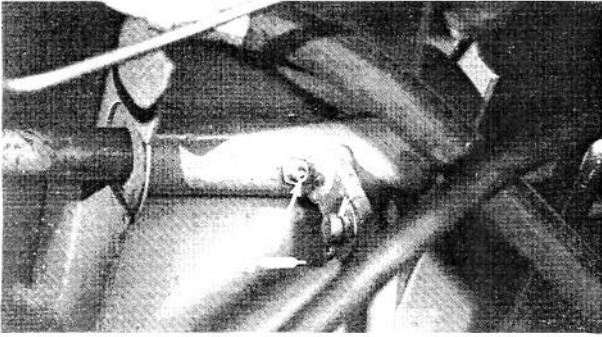

Figure 35

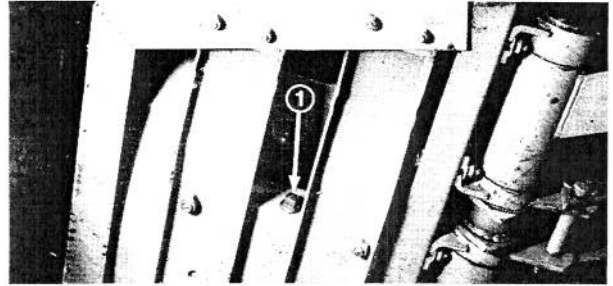

Figure 39

1. Engine oil drain

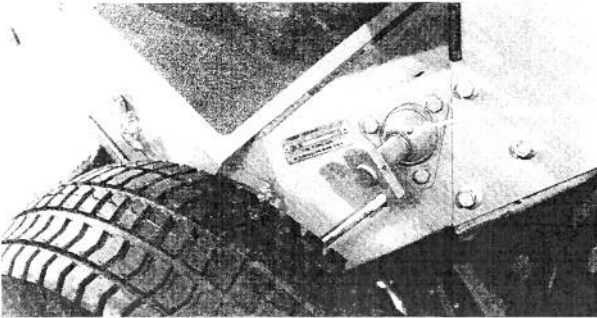

Figure 36

1. Two fittings — one on each side

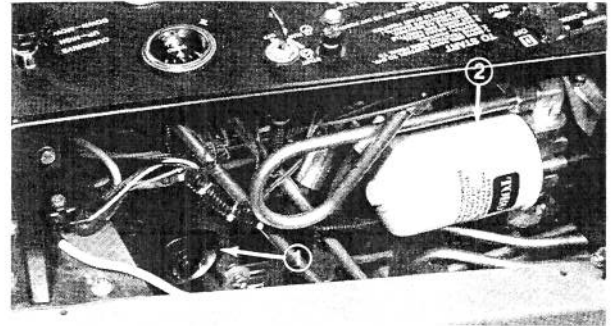

Figure 40

1. Engine oil filter 2. Hydraulic oil filter

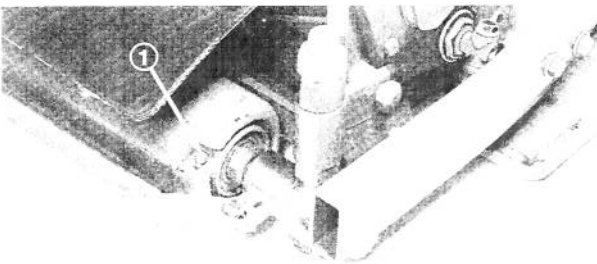

Figure 37

1. Six fittings — two per roller

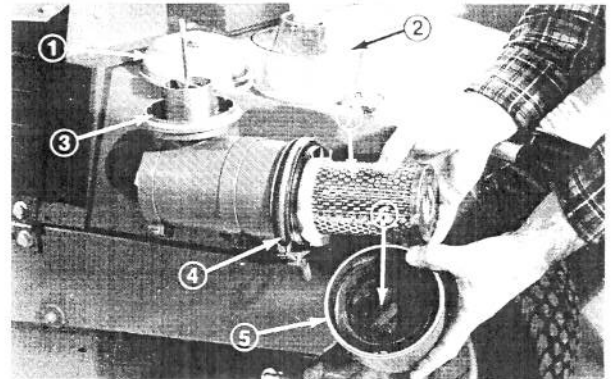

Figure 41

1. Cover 4. Mounting band 6. Baffle
2. Bowl 5. Cap 7. Element
3. Sleeve

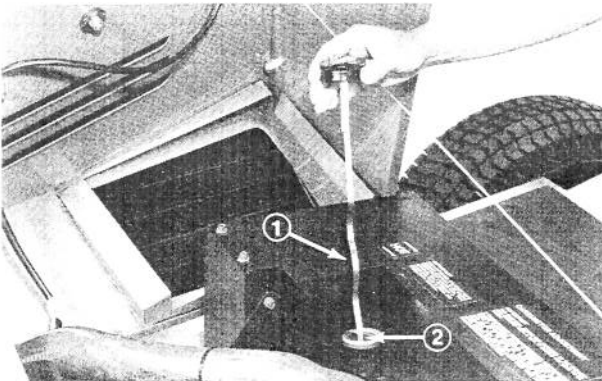

Figure 38

1. Dipstick
2. Oil fill hole

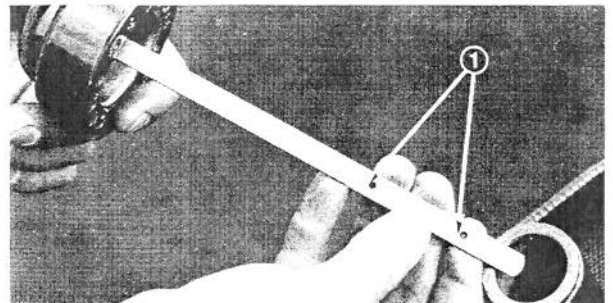

Figure 42

1. Oil level between holes

MAINTENANCE

CHECK ENGINE OIL PRESSURE

1. Raise cover over engine and remove oil pressure plug from top of engine (Fig. 43). Install an oil pressure gauge into the hole in the crankcase; refer to instructions outlined in Lubrication section of Kohler Engine Manual for installation instructions.

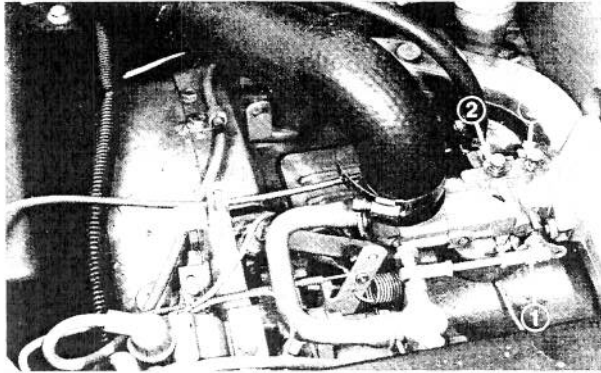

Figure 43

1. Oil pressure plug location
2. Main adjustment screw
3. Idle adjustment screw

2. Crank the engine over by holding the ignition key in the START position and check the oil pressure when the engine oil is cold. Use the following readings as a guide in determining the proper repair procedure to follow:

- A. Below 15 psi (103 kPa) — Locate oil pressure adjustment screw on lower corner of crankcase just forward of No. 1 cylinder (refer to Kohler Engine Manual). Loosen locknut and turn screw one turn clockwise. Tighten locknut, crank the engine over and check pressure. If pressure exceeds 15 psi (103 kPa), start engine and adjust pressure per Kohler manual. If pressure is still below 15 psi (103 kPa), repeat adjustment and checking of pressure. If pressure is still below 15 psi (103 kPa), problem is with internal components of the engine. Disassemble engine and repair as necessary.
- B. Pressure readings at near 0 psi (0 kPa) — Internal failure of engine components. Disassemble engine and repair as necessary.
- C. Pressure readings above 15 psi (103 kPa) — Problem is not due to low engine oil pressure. Something has been overlooked in previous checking procedures. Recheck system.

CARBURETOR ADJUSTMENT

IMPORTANT: A carburetor adjustment that is slightly on the lean side may not noticeably affect engine performance, but will cause higher combustion chamber temperatures which will shorten engine life.

The carburetor is adjusted at the factory and should not have to be reset. If an "over rich" condition appears to exist, check the air cleaner. Most "over rich" conditions are due to a poorly serviced clogged air cleaner element, not an improperly adjusted carburetor. Should the carburetor require adjustment use the following procedures:

1. Bend the clip away from the main adjustment screw (Fig. 43) and turn the screw clockwise until it lightly bottoms. Turn the idle adjustment screw clockwise until it also lightly bottoms (Fig. 43).
2. Turn the main screw counterclockwise four full turns and the idle screw one and one fourth turns, start the engine and allow it to warm up.
3. Increase throttle setting to full, slowly turn main adjustment screw clockwise (lean) until engine starts to slow down, then turn screw counterclockwise one half turn and bend clip to discourage tampering.
4. Slow throttle to idle, turn idle screw slowly clockwise (lean) until the engine slows and then counterclockwise (rich) until engine slows again. Note position of screw at both settings and adjust screw to a setting approximately midway between the lean and rich adjustments.
5. Check idle speed and adjust to 1200 RPM.

ENGINE CARE

The Engine Manual Supplied with your Turf Pro 84 provides the maintenance procedures for oil requirements, ignition components, etc. See Fig. 38, 39 & 40 for oil fill and dipstick, oil drain and oil filter location.

Note: Recommended cylinder head service interval is 250 hours when using leaded fuel. This interval may be increased to 500 hours if unleaded fuel is used.

FUEL PUMP

Fuel pump is located on left rear under side at rear of engine. Replace the internal fuel filter if fuel flow is restricted. Fuel Pump pressure is 3½ p.s.i. (Fig. 44).

MAINTENANCE

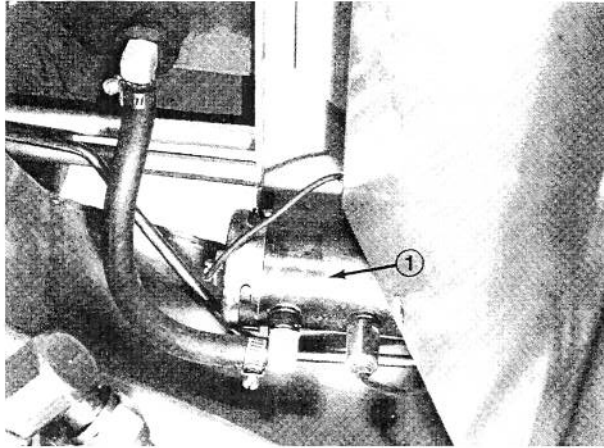

Figure 44
1. Fuel pump

BATTERY CARE

1. Battery electrolyte level must be properly maintained and the top of the battery kept clean. If the Turf Pro 84 is stored in a location where temperatures are extremely high, the battery will run down more rapidly than if the machine is stored in a location where temperatures are cool.

2. Unlatch and open engine cowl, remove the cover and check the electrolyte level every 25 operating hours or, if machine is in storage, every 30 days (Fig. 45).

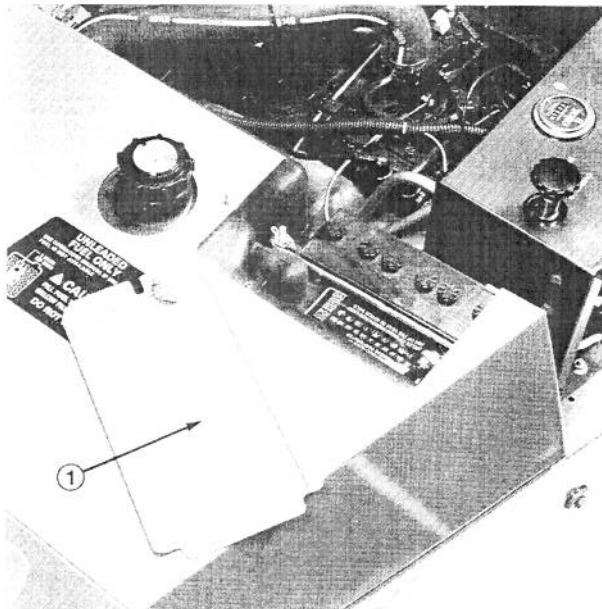

Figure 45
1. Cover

3. Maintain cell level with distilled or demineralized water. Do not fill cells above the bottom of the split ring inside each cell.

4. Keep top of battery clean by washing periodically with a brush dipped in ammonia or bicarbonate of soda solution. Flush the top surface with water after cleaning. Do not remove the fill caps while cleaning.

5. Battery cables must be tight on terminals to provide good electrical contact.

6. If corrosion occurs at terminals, disconnect cables and scrape clamps and terminals separately. Re-connect cables and coat terminals with petroleum jelly.

BATTERY STORAGE

If the machine will be stored more than 30 days, remove the battery and charge it fully. Either store it on the shelf or on the machine. Leave the cables disconnected if stored on the machine. Store the battery in a cool atmosphere to avoid quick deterioration of the charge in the battery.

BATTERY REMOVAL

Tools Required: 3 to 4 amp Battery Charger, Specific Gravity Tester, 7/16 inch Wrench.

1. Unlatch and open cowl over engine. Remove cover over battery (Fig. 45).



CAUTION

Since the gasses from the battery and the gasoline fumes are explosive, keep open flame and electrical spark away from the area; do not smoke.

2. Remove the negative (-) cable before removing the positive (+) cable to prevent any sparks from occurring.

3. Remove the battery hold down clamp and remove battery.

4. Charge battery per instructions in Activate and Charge Battery, page 13. Reinstall battery in reverse order.

BRAKE ADJUSTMENT

Tools Required: 1/2 in. Wrench.

MAINTENANCE

A brake adjustment rod is located on each side of the Turf Pro 84 so the brakes can be equally adjusted. (Fig. 46). Adjust the brakes as follows:

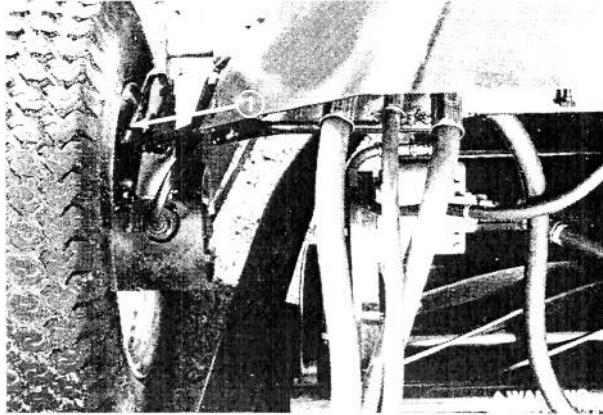

Figure 46

1. Brake rod and yoke

1. Transport the Turf Pro 84 and depress the brake pedal; both wheels should lock equally.



CAUTION

As a safety precaution, always check brakes in a wide, open spaced, flat area which is free of other persons and obstructions before and after adjustment.

2. If the brakes do not lock equally, disconnect the brake rods by removing the locknut from the rod. Disconnect the rod from the brake lever and turn it in the yoke to adjust. Re-install the rod and locknut.

3. Check the amount of free travel of the brake pedal when adjustment is completed. There should be 1/4 to 1/2 in. (6 to 13 mm) travel before the brake shoes make contact with the brake discs. Readjust, if necessary, to achieve this setting.

4. Transport the Turf Pro 84 and depress the brake pedal; both brakes should lock equally. Re-adjust, if necessary.

REMOVAL OF BRAKE ASSEMBLY

Tools Required: Jack, wheel and frame blocks, 9/16 in. wrench, 1/2, 5/8 & 1-1/2 in. socket wrench, with extra long handle, pliers, wheel hub puller, torque wrench.

DISASSEMBLY

1. Place blocks on each side of opposite wheel,

jack Turf Pro 84 up and place blocks beneath frame under wheel motor.

2. Remove wheel nuts and remove wheel.

3. Remove clevis pin from actuating lever lock-nuts and capscrews from secondary bracket and remove assembly from brake disc (Fig. 47).

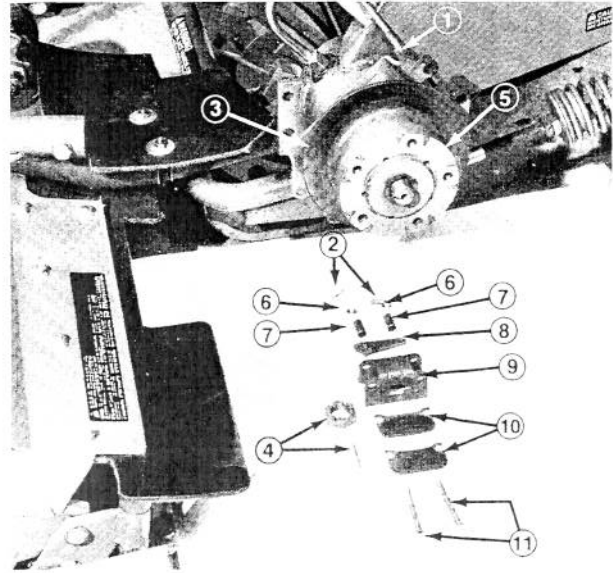

Figure 47

- | | |
|------------------------------|----------------------|
| 1. Yoke | 7. Split spacers |
| 2. Clevis pin and cotter pin | 8. Actuating lever |
| 3. Brake disc | 9. Secondary bracket |
| 4. Hub nut and cotter pin | 10. Brake pads |
| 5. Hub | 11. Capscrews |
| 6. Locknuts | |

4. Visually inspect brake pads and brake disc for wear. Replace parts as necessary.

5. If brake disc needs replacement remove large hub mounting nut, (Fig. 47), mount a wheel puller to wheel hub and shaft and remove wheel hub (Fig. 48). Remove the key from the shaft.

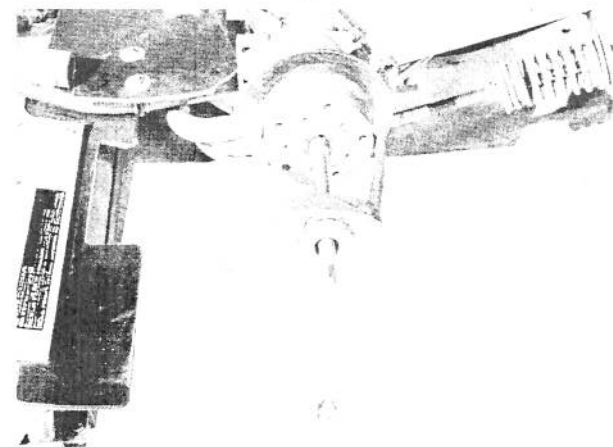

Figure 48

MAINTENANCE

6. Remove the five (5) capscrews securing the brake disc from the hub (Fig. 49).

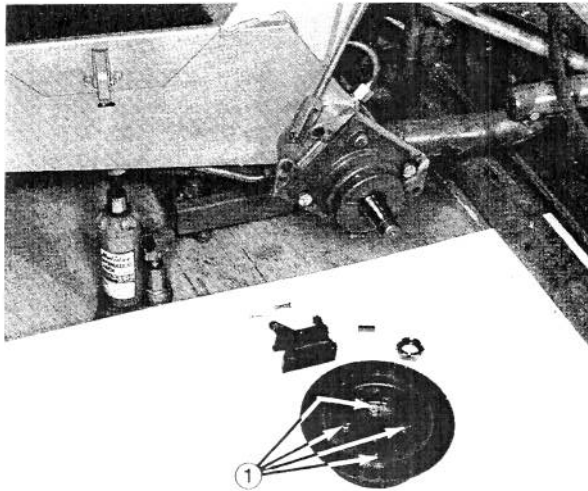

Figure 49

1. Brake disc mounting capscrews

REASSEMBLY

1. Mount the key in the wheel shaft so the top of the key is in line with the taper of the shaft and install the wheel hub and nut. Torque the nut to 125 ft-lb (169.5 N·m). Tighten nut further to align holes for cotter pin. **DO NOT BACK NUT OFF.**

2. Reassemble in reverse order. Insure actuating lever assembly pin fits in lower dimple of secondary bracket of disc brake assembly (Fig. 50).

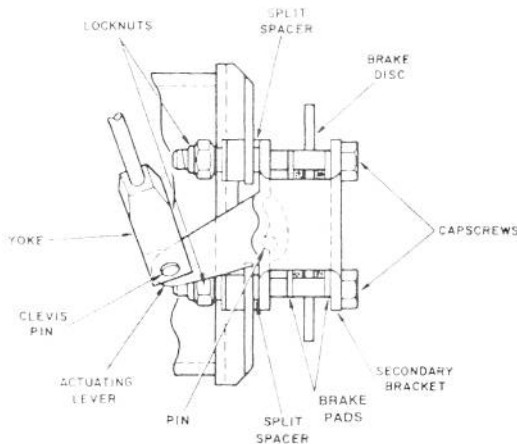

Figure 50

3. Tighten locknuts on secondary mount bracket capscrews until capscrews can be just rotated with fingers and tighten locknuts 1/4 turn further (Fig. 50).

Note: Do not overtighten or brake pads will not be properly aligned with brake disc.

4. Install brake rod. Connect the actuating linkage and secure the clevis pin with a cotter pin.

5. Install the wheel assembly. Torque the wheel nuts to 45-55 ft-lb (61-75 N·m).



WARNING

Tighten front wheel nuts to 45-55 ft-lb (61-75 N·m) after 1-4 hours of operation and again after 10 hours of operation and every 250 hours thereafter. Failure to maintain proper torque could result in failure of or loss of a wheel and may result in personal injury.

6. Adjust and check the brakes by following the procedures listed under Brake Adjustment, page 26.

STEERING ASSEMBLY SERVICING

Tools Required: Hammer, Drift Punch, 7/16, 9/16 in. Wrenches, Pliers.

To remove front steering shaft assembly:

1. Remove steering wheel and steering Tower Cover (Fig. 51).

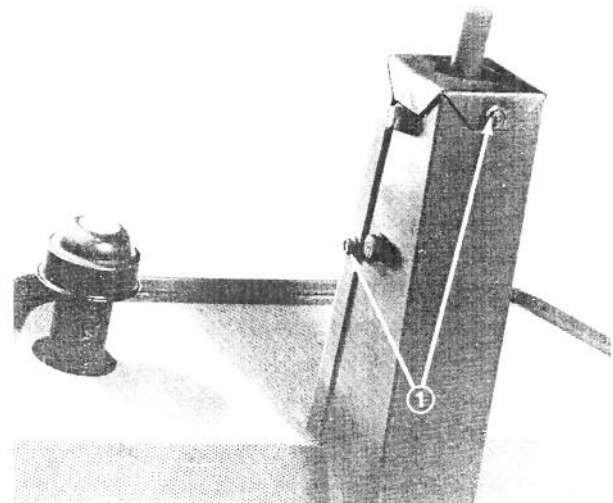

Figure 51

1. Capscrews – steering column cover

2. Remove two (2) Locknuts securing lower Steering Arm Follower and remove Steering Arm Follower from Steering Follower (Fig. 52).

MAINTENANCE

3. Disassemble two (2) Springs from Lower Sleeve, remove sleeve from Steering Follower to expose capscrew in lower end of Steering Shaft and remove Capscrew (Fig. 52).

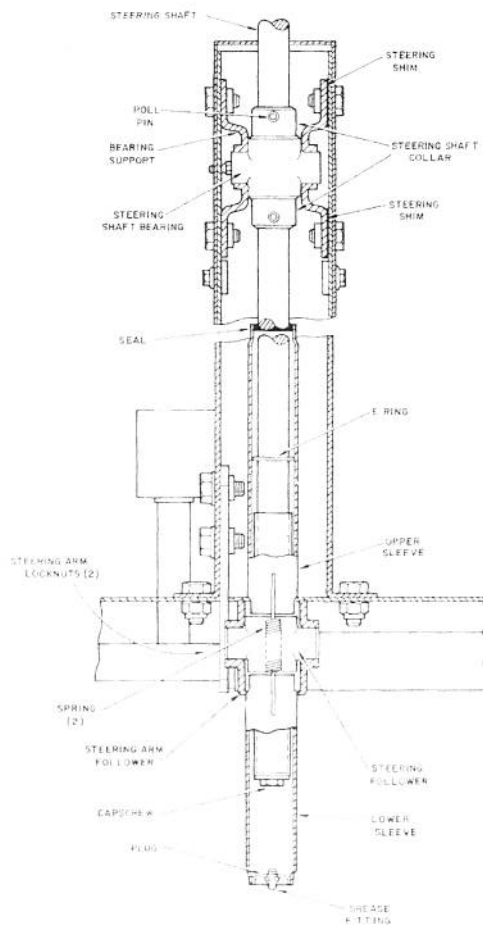

Figure 52

4. Remove four (4) capscrews securing Top Bearing Assembly. Retain any shims installed between Bearing Support and Tower Housing (Fig. 53).

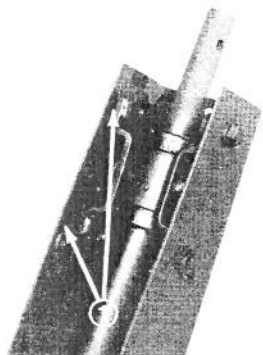

Figure 53

1. Steering shims

5. Remove Steering Shaft from Tower Housing and remove top Steering Shaft Bearing and E Ring from shaft.

6. Disassemble Upper Sleeve from top of Steering Shaft to prevent damage to Upper Sleeve Seal and remove Steering Follower from shaft.

7. Replace parts as necessary and reassemble in reverse order. Insert only enough shims between Bearing Support and Tower housing to remove most all side play from the assembly. Excessive number of shims will bind Upper Bearing and not allow it to pivot. Excessive number of shims will also cause difficulty in fitting Tower Cover over Tower Housing.

REPAIRING FRONT COUNTERBALANCE

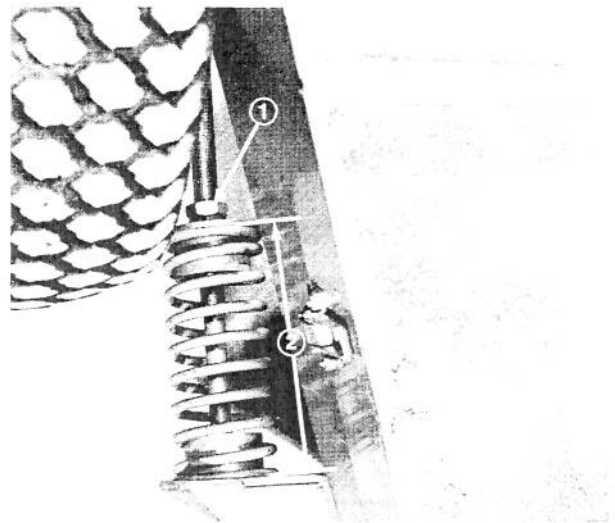

Figure 54

1. Jam nuts
2. $6\frac{1}{2} \pm \frac{1}{4}$ inches (16.5 cm \pm 6 mm)

Tools Required: Pliers, 1-1/8 inch Wrench, Tape Measure.

1. Raise cutting units to transport position and remove and replace faulty parts.

2. Adjust spring length with jam nuts to $6\frac{1}{2} \pm \frac{1}{4}$ inch (16.5 cm \pm 6 mm) length when reassembling. Adjust both right and left springs to assure equal pressure will be exerted against front push arms.

REPAIRING REAR COUNTERBALANCE

If any part of counterbalance assembly ever needs repair or replacement parts, repair and adjust flange locknuts on U-bolt to top of threads for initial adjustment.

MAINTENANCE

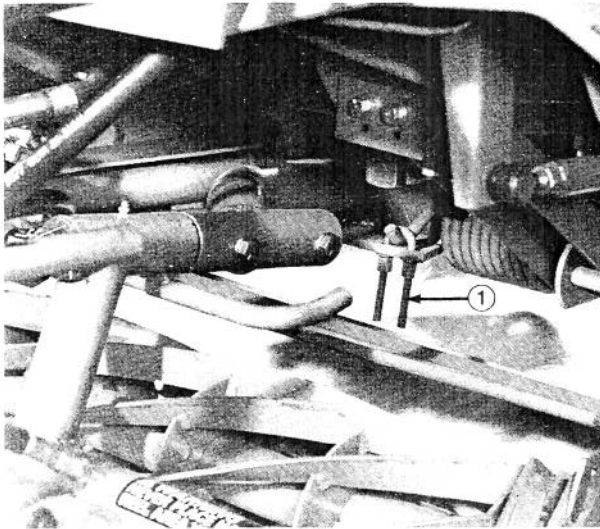

Figure 55
1. U-bolt

Usually, no further adjustment will be necessary. Machine will function at best performance level at this setting.

BACKLAP OPERATION

Tools Required: Toro Part No. 29-9100 Handle Assembly, Lapping Compound, 4 x 4 in. (10 x 10 cm) Wheel Blocks.

Backlap when reel blade and bedknife edges are slightly rounded and do not cut the grass cleanly with a light bedknife to reel adjustment. Also backlap after a reel and bedknife have been re-ground to establish a land area and ensure a perfect match between reel and bedknife cutting edges. Backlapping will not correct nicked or severely rounded reel blades or uneven bedknife wear. Correct these conditions by replacing or regrinding the components.

Use a good grade of medium grit (80) commercial lapping compound with a water soluble carrier to assure the compound will be easily washed away at the completion of the backlapping operation. Dry lapping compound should be mixed with liquid detergent until the material is of free flowing consistency.

Note: Paste-type pre-mixed lapping compound is also sold in some areas. This is generally used in its original composition and therefore is not free flowing.

BACKLAP AS FOLLOWS:

1. Two persons are necessary to perform the

backlapping operation, one to work the controls and one to apply lapping compound and perform necessary adjustment (Fig. 60).

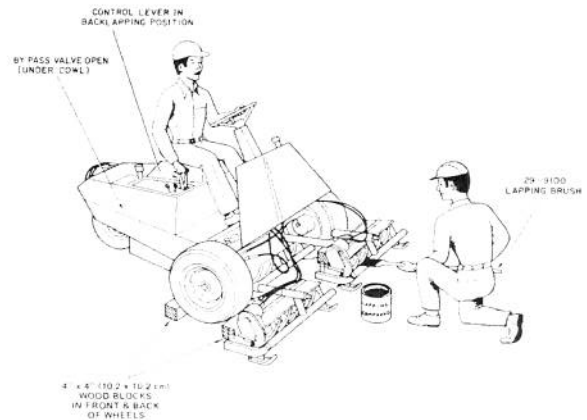

Figure 56



CAUTION

All persons working on the machine during the backlapping operation must stay alert. All unnecessary personnel must be kept away to prevent distraction. Since reels are under power during backlap operation and contact with reels can cause personal injury, the operator of the Turf Pro 84 controls must be fully instructed on proper operating procedures and start reel operation only on direct instruction from the mechanic and only when he is fully in view.

2. Engage the parking brake, block the front wheels, start the engine and lower the cutting units. Turn the engine off. Make a precise bedknife to reel adjustment to all cutting units to assure the bedknife is parallel with the reel and light contact is evident; see Cutting Unit Bedknife to Reel Adjustment, page 21.

3. Unlatch and open the engine cowl and remove the floor plate. Turn the Bypass Valve until the flats on the valve stem face forward and rearward (pushing or towing mode) to prevent the machine from moving, install floor plate and close the engine cowl (Fig. 57).

4. Have assistant on seat start engine and adjust throttle lever to SLOW throttle setting.

5. Dip 3 inch (76 mm) paint brush attached to Toro Part No. 29-9100 Handle Assembly into lapping compound, stand clear of cutting units

MAINTENANCE

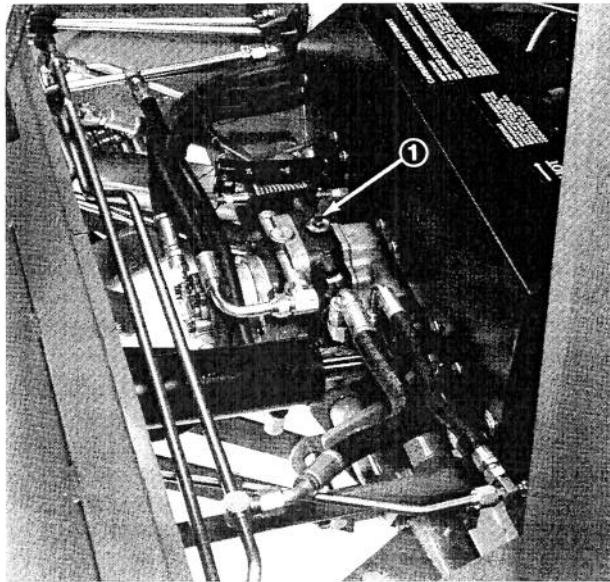

Figure 57

1. By-pass valve

and instruct assistant to position cutting unit control lever in BACKLAP.



DANGER

Under no circumstances use a short handled paint brush. 29-9100 Handle Assembly complete or individual parts are available from your local Authorized TORO Distributor.

6. Apply lapping solution evenly over full length of all three reels assuring all reel blades are covered. Re-apply lapping solution whenever noise of reel operating against bedknife begins to disappear or when reel appears to have uneven concentrations of material.

7. Adjust, when necessary, to maintain light contact between the reel and bedknife.



DANGER

DO NOT ADJUST CUTTING UNITS WHILE REELS AND ENGINE ARE OPERATING. Instruct assistant to stop reels and shut engine off when adjustment is necessary.

8. Backlap until the cutting edges are sharp, even and consistent on all reel blades. A 1/32 inch (0.79 mm) minimum land area must be achieved on newly sharpened reel assemblies.

9. Stop the reels and shut the engine off upon completion. Lightly pass a fine file across the front face of bedknife to remove any burr and wash the units thoroughly of all lapping material with a low pressure stream of water.

10. Check the sharpness of the reel and bedknife with strips of newsprint. The paper should be cleanly sheared across the entire width of the bedknife and reel with light contact. Continue back-lapping if newsprint is not sheared acceptably.

11. Open the engine cowl, remove the floor plate and close the By-pass Valve by turning valve stem until flats face toward sides of machine.

CUTTING UNIT AND FRAME SERVICING

Tools Required: 3/8, 1/2, 9/16, 1-1/8 inch Wrenches, Pliers.

Refer to the Cutting Unit Operator's Manual for proper servicing instructions.

To remove the cutting unit from the machine for service:

1. Lower cutting units, disassemble top shield fasteners opposite motor end, remove inspection cover from chain case, loosen chain idler, push reel motor mounting capscrews back but do not remove or "O" rings will be displaced. Remove shield, lift chain off motor sprocket and remove motor (Fig. 58).

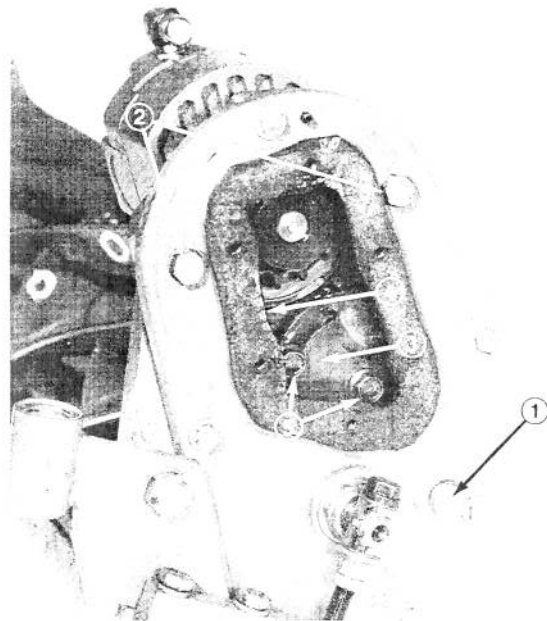



Figure 58

- | | |
|----------------------------------|-----------------------------|
| 1. Fill plug | 4. Drive chain |
| 2. Reel motor mounting capscrews | 5. Idler mounting capscrews |
| 3. Idler assembly | |

MAINTENANCE

2. Insert caplug or shipping cover, into motor mount hole and remount inspection cover with capscrews finger tight to prevent contamination.

 **WARNING**

Center push arm is spring loaded. Loosen the nuts on rear counter-balance U-bolt (Fig. 55) to decrease spring tension on center push arm when removing cutting unit.

3. Remove ball-loc pin, cotter pin and washer from pivot shaft (Fig. 59) and slide carrier frame and cutting unit off pivot shaft.

Note: One front unit and carrier frame must be removed in order to remove No. 1 cutting unit.

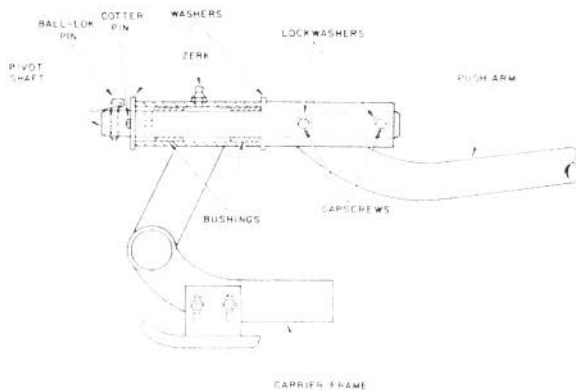

Figure 59

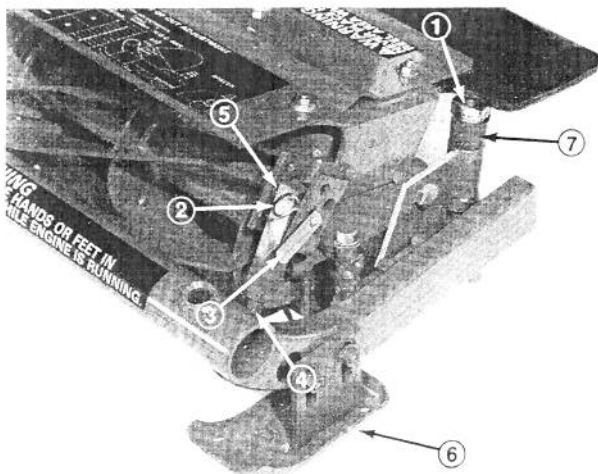

Figure 60

- | | |
|----------------------|------------------------------------|
| 1. Taper nut | 5. Height-of-cut block |
| 2. Hairpin cotter | 6. Skid |
| 3. Height-of-cut pin | 7. Height-of-cut spacer (optional) |
| 4. Jam nut | |

4. Remove hair pin cotters, height of cut pins and taper nuts from cutting unit, lift cutting unit off rod ends and remove from frame (Fig. 60).

REEL DRIVE CHAIN ADJUSTMENT

Check chain tension every 50 hours during initial operation until chain has discontinued wear-in and tension does not need adjustment. Extend tension check intervals out to every 100 hours after this occurrence.

1. Remove inspection cover from chaincase cover taking care not to damage gasket.

2. Check chain tension (Fig. 58). Chain should have 0 to 1/8 in. (0 to 3 mm) deflection when properly adjusted and should be retensioned when deflection exceeds 1/4 in. (6 mm). Rotate reel while checking to ensure all portions are within specification. If tension is correct, proceed to step 6. If tension is incorrect, proceed to step 3.

3. Loosen idler mounting capscrews (Fig. 58). Rotate the reel by hand, watching for the sprocket position where the chain tension is tightest. At this point make a final idler adjustment, fingertight, for chain deflection.

4. Torque idler capscrews to 150-170 in.-lb (17-19 N·m).

5. Rotate reel and check tension. Chain should not exceed 1/8 in. (3 mm) total deflection, or no more than 1/16 in. (1.6 mm) in either direction from center line of chain. Readjust, if necessary.

6. Install inspection cover and torque capscrews to 40-50 in.-lb (4.5 - 5.6 N·m).

SERVICING THE REAR ROLLER ASSEMBLY

Tools Required: 9/16, 3/4, 1-1/8 inch Wrenches, McLube 1725, Torque Wrench, Container.

Disassembly:

1. Remove top taper nut from each rod end (Fig. 61).

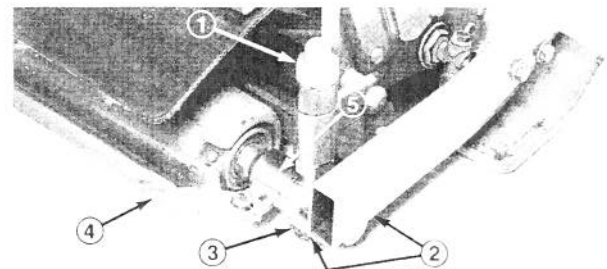

Figure 61

- | | | |
|-----------------------|----------------------------|--------------------|
| 1. Top taper nuts (2) | 3. Brackets (2) | 5. Extension shaft |
| 2. Cap screws (4) | 4. Optional roller scraper | |

2. Remove four (4) cap screws securing roller to frame and slide roller and rod ends out of bed-knife frame (Fig. 65).

MAINTENANCE

3. Remove rod ends and roller extension shafts from both ends of roller (Fig. 61).

4. Remove lock nut.

Note: After lock nut has been removed, slide sleeve off roller shaft. Point end of roller downward into a container, at the same time pulling roller shaft out, allowing lubricant to drain from roller.

5. If roller shaft is to be replaced, remove double jam nuts.

6. Remove remaining sleeve and seals from both ends of roller.

7. Remove bearing cones from each end of roller.

8. Remove bearing cups with caution.

9. Remove inner seals by using a seal remover.

Roller Assembly:

1. Lightly oil lips of inner seals. Install inner seals on each end of roller, making sure that garter springs face inboard.

2. Replace bearing cups and insert bearing cones into roller.

3. Lightly oil lips of outer seals. Install outer seals on each end of roller, making sure that garter springs face inboard.

4. Install jam nuts and slide one (1) sleeve onto roller shaft against double jam nuts.

5. Wrap threaded area of roller shaft with cellophane tape to protect seals, and carefully slide shaft through right-hand side of the roller. Slide roller shaft into roller until it penetrates the innermost oil seal on the right-hand side.

6. Pour approximately one (1) pint (16 ounces [0.473 L]) of SAE 90 or 140 gear oil into the roller housing.

7. After oil has been added, carefully push roller shaft through the entire roller assembly. Remove cellophane tape.

8. Install sleeve on roller shaft and slide up against bearing cone.

9. Install lock nut and secure by holding double jam nuts. Tighten lock nut.

Note: Tighten lock nut until all axial and radial motion has been removed from the roller shaft and bearings. Ensure that roller rotates freely on shaft.

10. Grease bearings with wheel bearing grease.

11. Apply McLube 1725 to roller extension shaft bushings and rod end bushings, let dry and install rod end and extension shaft assemblies.

12. Re-assemble to frame of machine with double jam nuts on roller shaft located at left side of carrier frame.

AIR CLEANER SERVICING

General Maintenance Practices

Inspect air cleaner filter element and hose monthly to maintain maximum engine protection and to insure maximum service life.

1. Assure hose between air cleaner and carburetor is clamped securely in place. Replace the hose if it is cracked or punctured.

2. Check air cleaner body for dents and other damage which could possibly cause an air leak. Replace a damaged air cleaner body.

3. Make sure bowl is sealing around bottom of sleeve assembly (Fig. 62).

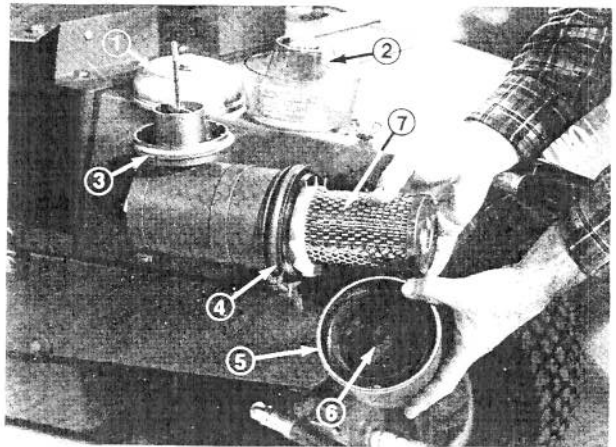

Figure 62

- | | | |
|-----------|------------------|------------|
| 1. Cover | 4. Mounting band | 6. Baffle |
| 2. Bowl | 5. Cap | 7. Element |
| 3. Sleeve | | |

4. Mounting screws and nuts holding air cleaner in place must be tight.

5. Inlet cover must be free of obstructions.

Servicing Bowl Assembly

Visually inspect the bowl once a week; however, daily inspection is required when operating conditions are extremely dusty and dirty. Never allow

MAINTENANCE

dust to build up above level marks on outside of bowl (Fig. 63).

1. Loosen thumb screw until cover and bowl can be removed (Fig. 63). Separate cover and bowl.
2. Dump dust out of bowl and clean bowl. After cleaning, assemble and reinstall both parts.

Servicing Air Cleaner Filter

Lack of power, excessive exhaust smoke—as if engine was being choked—and excessive oil consumption indicate air cleaner element needs cleaning. Replace element after six cleanings or annually, whichever occurs first.

1. Loosen mounting band and remove cap and baffle (Fig. 62). Remove baffle from cap, clean dirt from cap and re-install baffle.
2. Remove wing nut w/gasket and slide filter element out of air cleaner body (Fig. 62).

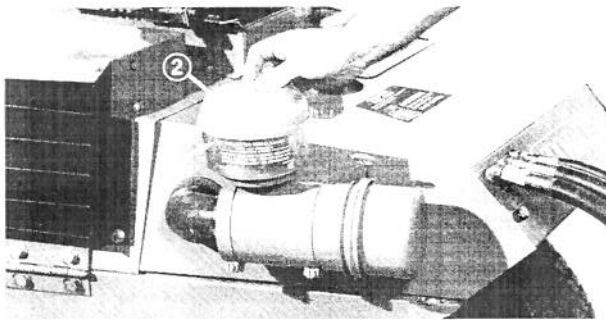

Figure 63

1. Level mark
2. Thumb screw

3. Clean the element by washing it in a solution of filter cleaner (Part No. 27-7220, available from Toro) and water, or blow dirt out of filter by using compressed air.

Note: Compressed air is recommended when element must be used immediately after servicing because a washed element must be dried before it is used. By comparison, washing the element cleans better than blowing dirt out with compressed air. Remember though, filter must be washed when exhaust soot is lodged in the filter pores.

Washing Method

IMPORTANT: Do not remove plastic fin assembly because washing removes dust from beneath fins.

- A. Prepare a solution of filter cleaner and water and soak filter element about 15 minutes. Refer to directions on filter cleaner carton for complete information.

- B. After soaking filter for 15 minutes, rinse it with clear water. Maximum water pressure must not exceed 40 psi (276 kPa) to prevent damage to the filter element.
- C. Dry filter element using warm, flowing air (160° F [71° C] max.) or allow element to air-dry. Do not use compressed air or a light bulb to dry the filter element because damage could result.

Compressed Air Method

IMPORTANT: Do not remove plastic fin assembly because back-blowing with compressed air removes dust from beneath fins.

- A. Blow compressed air from inside to the outside of dry filter element. Do not exceed 100 psi (689 kPa) to prevent damage to the element.
- B. Keep air hose nozzle at least one inch (25 mm) from pleated paper, and move nozzle up and down while rotating the filter element. Inspect element when dust and dirt are removed; refer to Inspecting Filter Element below.

4. Wipe inside of air cleaner body with a damp cloth to remove excess dust. Slide filter into air cleaner body and secure it in place with wing nut and gasket.
5. Reinstall cap and baffle. Move mounting band behind air cleaner body and tighten it securely.

Inspecting Filter Element

1. Place bright light inside filter.
2. Rotate filter slowly while checking for cleanliness, ruptures, holes and tears. Replace defective filter element.
3. Check fin assembly, gasket and screen for damage. Replace filter if damage is evident.

SERVICING REAR WHEEL SPINDLE ASSEMBLY

Tools Required: Wheel Blocks, Jack, Jack Stands, Screwdriver, Drain Pan, Pliers, Wheel Puller, 7/16, 9/16, 11/16, 3/4, 1-1/2, 1-7/8 inch Wrenches.

Remove and replace rear spindle assembly and bearings as follows:

1. Lock parking brake, block front wheels, place jack under frame on rear wheel side and jack up rear of machine, use jack stands or place blocks under machine for additional support.

MAINTENANCE

2. Remove two (2) capscrews securing rear cover, remove fuel cap, lift cover over rear hydraulic lines and slide cover rearward to clear fuel tank and battery (Fig. 64).



DANGER

Handle gasoline with care. Assure there is adequate ventilation as gasoline fumes are highly volatile. **DO NOT SMOKE OR EXPOSE GASOLINE TO OPEN FLAME OR POTENTIAL SPARKS WHILE HANDLING.** Wipe up any spilled gasoline. Store drained gasoline in an approved container.

3. Disconnect negative (-) cable from battery, place drain pan under fuel tank, remove fuel line from tank and drain fuel from tank.

4. Remove fuel tank, rear wheel, rear wheel hub, hydraulic motor and rear steering tube and socket assembly (Fig. 64). Do not kink or bend the hydraulic lines while removing the motor.

5. Remove cotter pin from spindle mounting nut, remove nut and disassemble bearings and spindle assembly from frame.

6. Replace worn parts and reassemble in reverse order. Pack the spindle bearings with #2 multi-purpose lithium base grease before installing spindle nut.

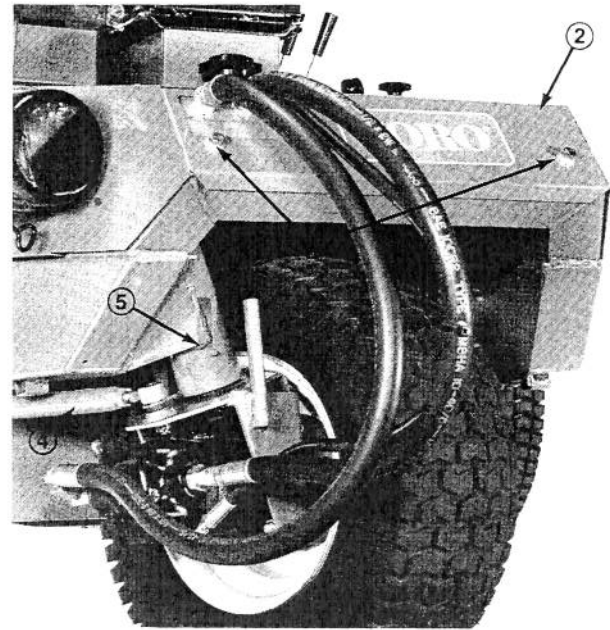

Figure 64

- | | |
|-----------------------------|------------------------------------|
| 1. Cover mounting capscrews | 4. Steering tube |
| 2. Rear cover | 5. Spindle assembly grease fitting |
| 3. Wheel motor | |

7. Tighten spindle nut until slight binding is evident when spindle is rotated. Back nut off to align first slot in nut with spindle hole and install new cotter pin to secure assembly.

8. Install remaining parts. Torque hub mounting nut to 125 ft-lb (170 N·m).

MAINTENANCE

IMPORTANT HYDRAULIC TROUBLESHOOTING AND TEST INFORMATION

The following instructions are intended as a guide for troubleshooting and testing TORO Turf products.

Before attempting to troubleshoot and test the machine, refer to the following list of items.

1. The following troubleshooting and test sections for each product are laid out as follows:

- A. Hydraulic circuit schematics.
- B. Symptom flow charts.
- C. Test Hook Up procedures

2. There is possibly more than one cause for a machine malfunction. All causes should be checked in the order in which they are listed on the flow charts. **DO NOT DEVIATE FROM THIS PROCEDURE.**

3. Thoroughly clean the machine before disassembling any of the hydraulic components.

4. Cap or plug any lines or ports left open or exposed during testing or removal of components.

5. It is important that all flexible hoses are free of twisting, bending or rubbing after fittings are tightened.

6. The engine must be in good operating condition. **ALWAYS** use a tachometer when making hydraulic tests as engine speed will affect the accuracy of testing readings.

7. When hooking up a hydraulic tester, always check that inlet and outlet lines are connected properly.

8. The hydraulic tester load (flow control) valve must be open before starting any tests.

9. Install hose fittings with fingers far enough to insure they are not cross threaded before tightening with a wrench.

10. The oil in the hydraulic system should be at operating temperature before tests are made. If the reservoir or hydraulic lines are warm to the touch, it's an indication of operating oil temperature.

11. Always keep in mind the need for cleanliness when working on hydraulic equipment.

12. Contact the TORO Distributor for information pertaining to hydraulic tester and fitting requirements to perform hydraulic tests.

13. Always keep safety in mind while tests are being made. Keep bystanders away from the equipment.

MAINTENANCE

Hydraulic Oil Flow when engine is started and all controls are in neutral. Gear pump draws oil from reservoir through suction line. Oil is pumped out from gear pump through Lift/Mow control valve through filter and back to reservoir. Small amount

of oil is drawn from return line to replenish oil drained from hydrostatic traction pump. Gerotor assembly inside hydrostatic pump is recirculating oil inside pump passages and is only component in operation in neutral mode.

HYDRAULIC CIRCUIT – TRACTION AND REEL DRIVE, NEUTRAL POSITION

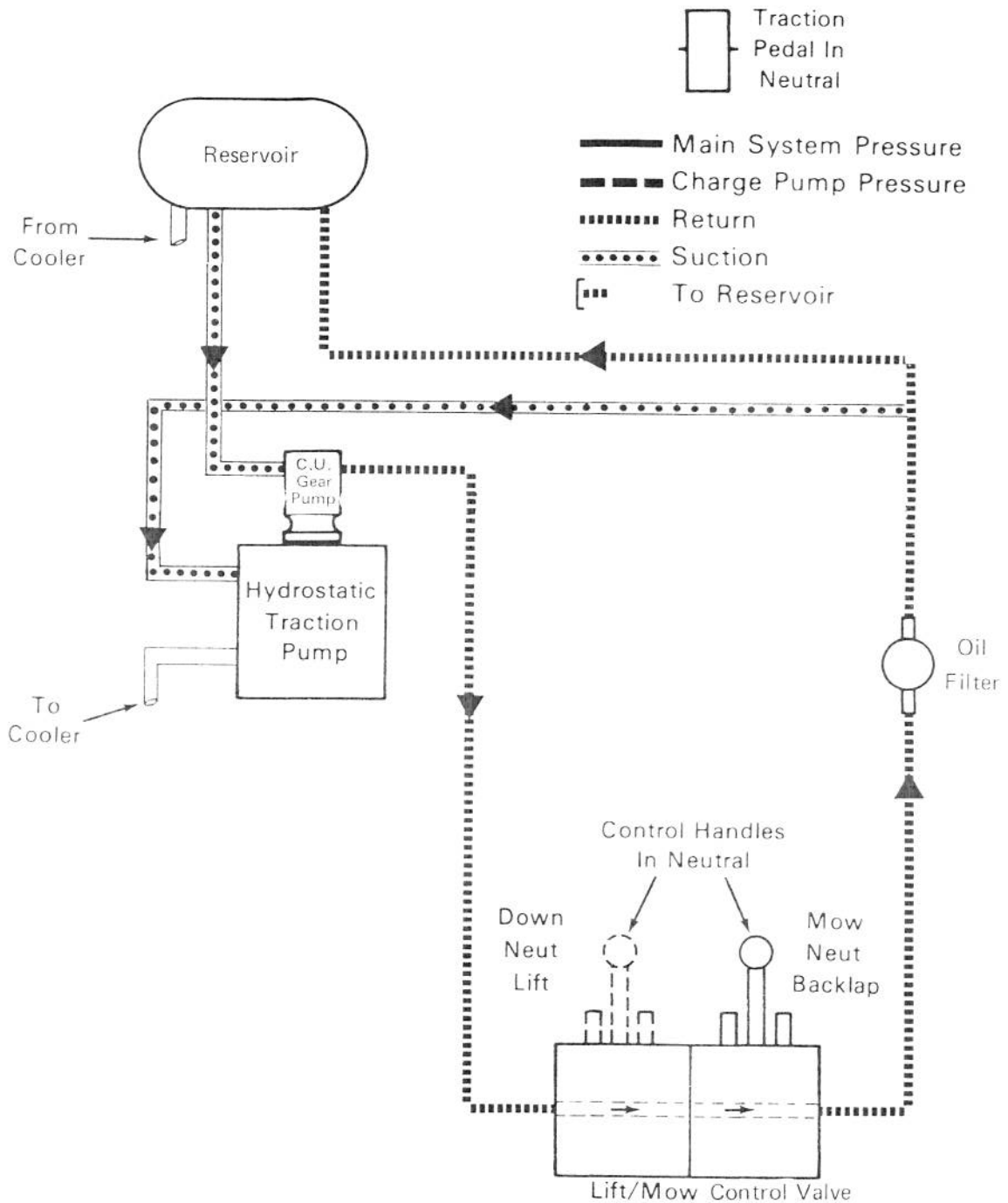

MAINTENANCE

Overdrive selector valve is down (MOW position) to allow three wheel drive for mowing operation. Front of traction pedal is depressed to provide forward operation. Pistons inside traction pump transmits high pressure oil to all three wheel motors causing them to rotate wheels in forward direction. Low pressure oil returns to traction

pump after driving wheel motors and expending its motive force. Small amount of oil drains from rear wheel motor to join with oil which has drained from traction pump and passed through oil cooler. Both portions return to reservoir. Oil leaked from pump is replaced by oil drawn by charge pump from filter return line.

HYDRAULIC CIRCUIT – TRACTION DRIVE
MOWING OPERATION

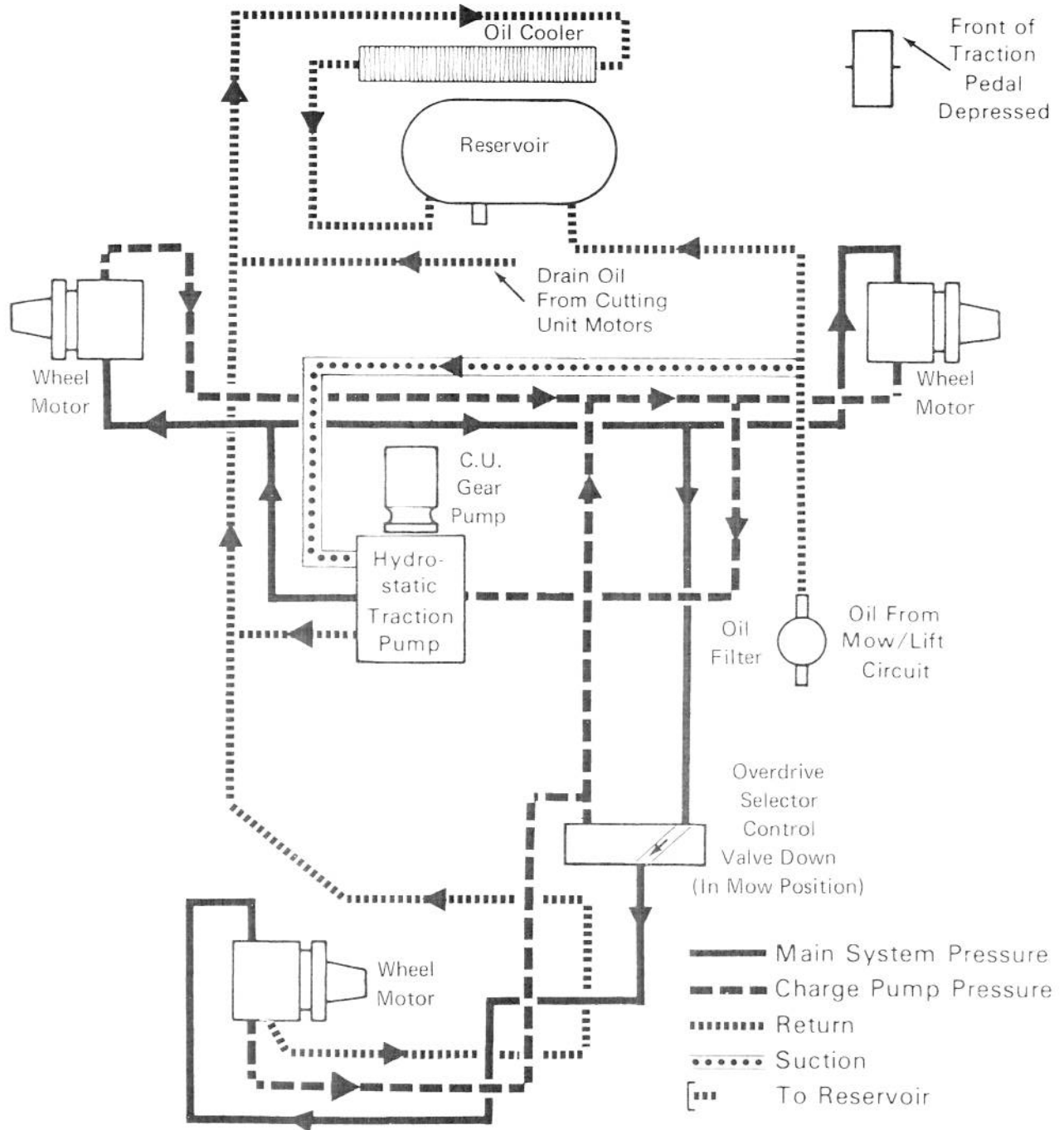

MAINTENANCE

Overdrive selector valve is up (HIGH position). This blocks high pressure oil from driving rear wheel motor and diverts it to increase flow to front wheel motors, which increases motor RPM, thereby increasing ground speed for transport operation.

Residual oil collected in rear wheel motor recirculates through rear motor lines. Rest of traction pump operation is identical to mowing operation: see page 38.

HYDRAULIC CIRCUIT – TRACTION DRIVE
FORWARD OPERATION, HIGH SPEED

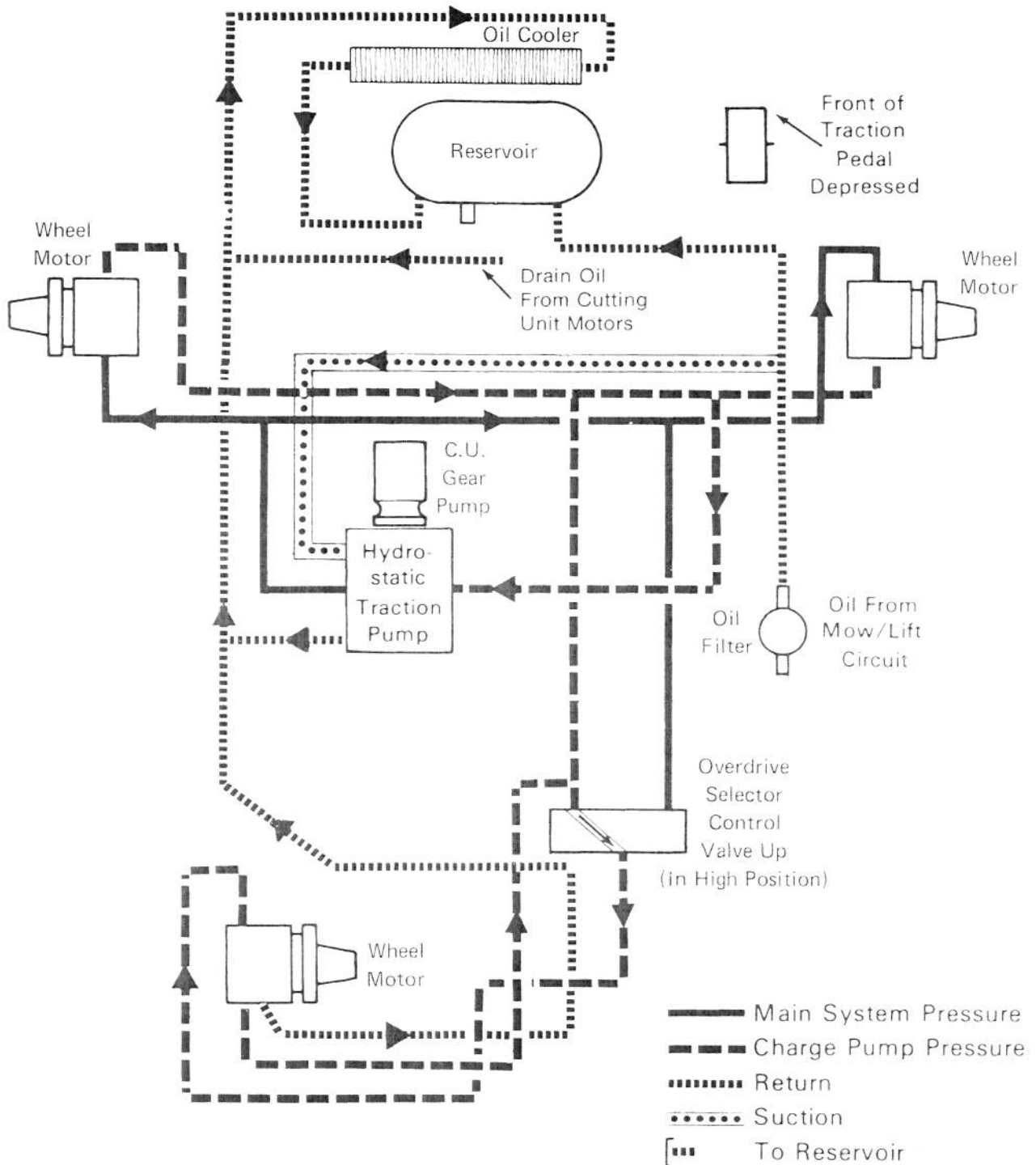

MAINTENANCE

Overdrive selector valve is down (MOW position) to allow three wheel drive. Rear of traction pedal is depressed, which changes direction of flow of high pressure oil from traction pump to wheel motors,

causing them to rotate in reverse direction. Low pressure oil from wheel motors return to traction pump. Drain oil function is as previously described.

HYDRAULIC CIRCUIT — TRACTION DRIVE
REVERSE OPERATION, SLOW SPEED

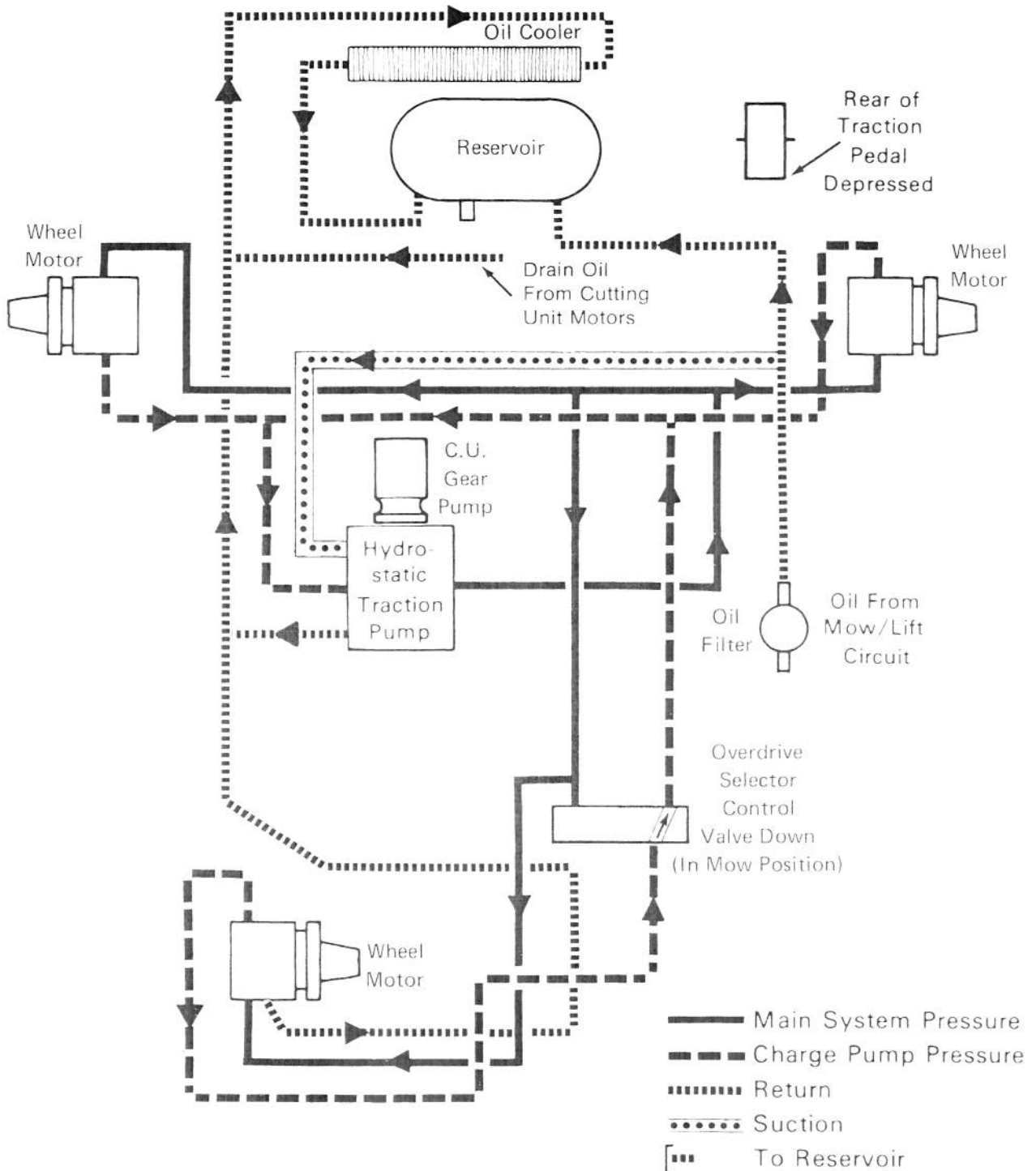

MAINTENANCE

Overdrive selector is up (HIGH position). This blocks high pressure oil from driving rear wheel motor and diverts it to increase flow to front wheel motors increasing their RPM, thereby increasing ground speed. Rear of traction pedal is depressed, which changes direction of high pressure oil from traction pump to wheel motors, causing them to rotate in reverse direction.

 **CAUTION**

Ground speed is considerably faster when overdrive selector is up (HIGH position). Take care while in reverse operation to avoid personal injury and damage to the machine.

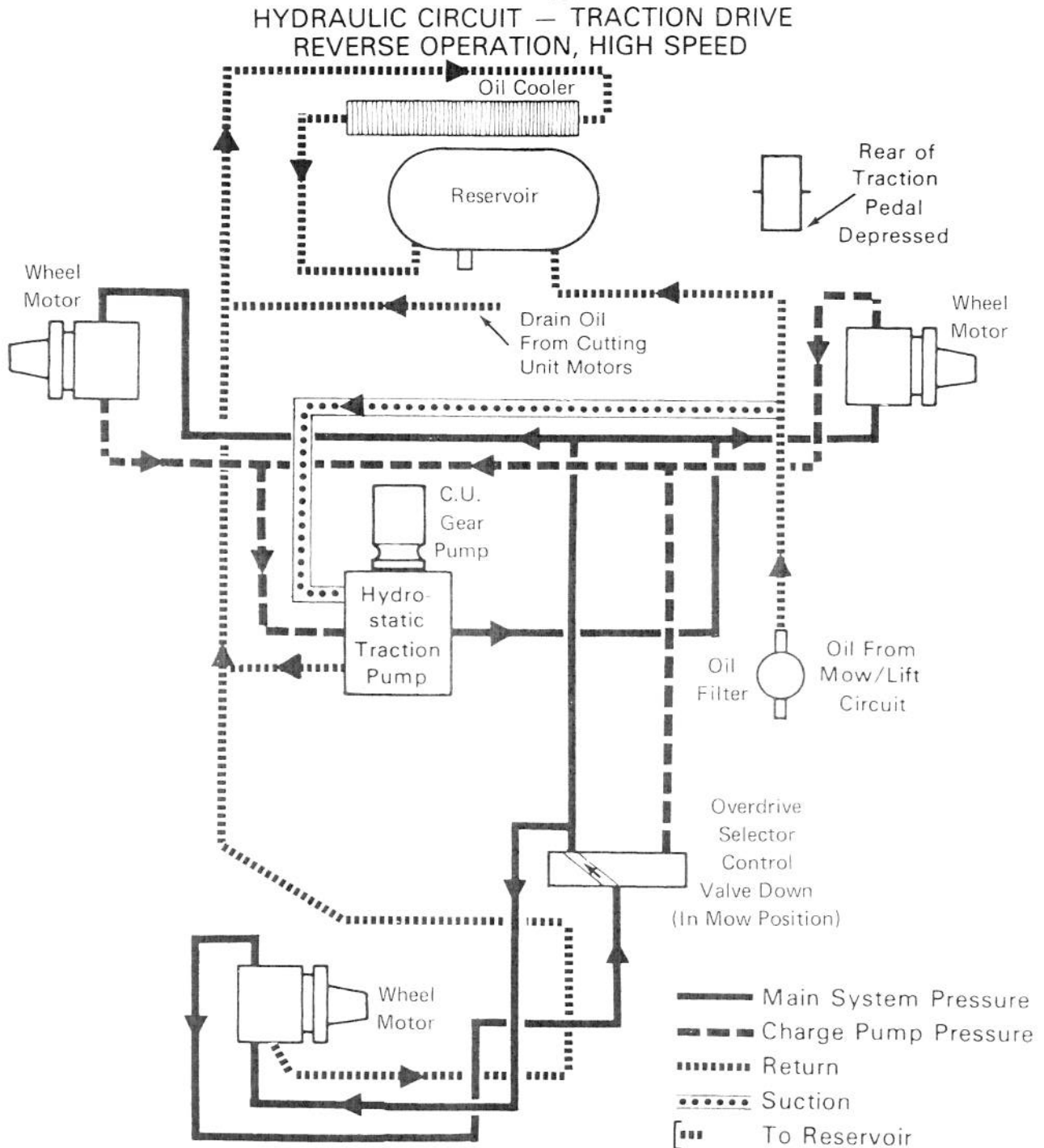

MAINTENANCE

First function to perform during cutting unit operation. Control handle is placed in DOWN position, which allows high pressure oil from gear pump to pass through control valve to hydraulic cylinder. Oil pressure forces cylinder piston and rod inward, which lowers cutting units. Oil on opposite side of

piston is forced out of cylinder and returns to control valve to filter and hydraulic reservoir.

A 2000 P.S.I. (13 790 kPa) relief valve in control valve opens if control lever is held in DOWN position after units are down.

HYDRAULIC CIRCUIT — REEL DRIVE
LOWERING CUTTING UNITS

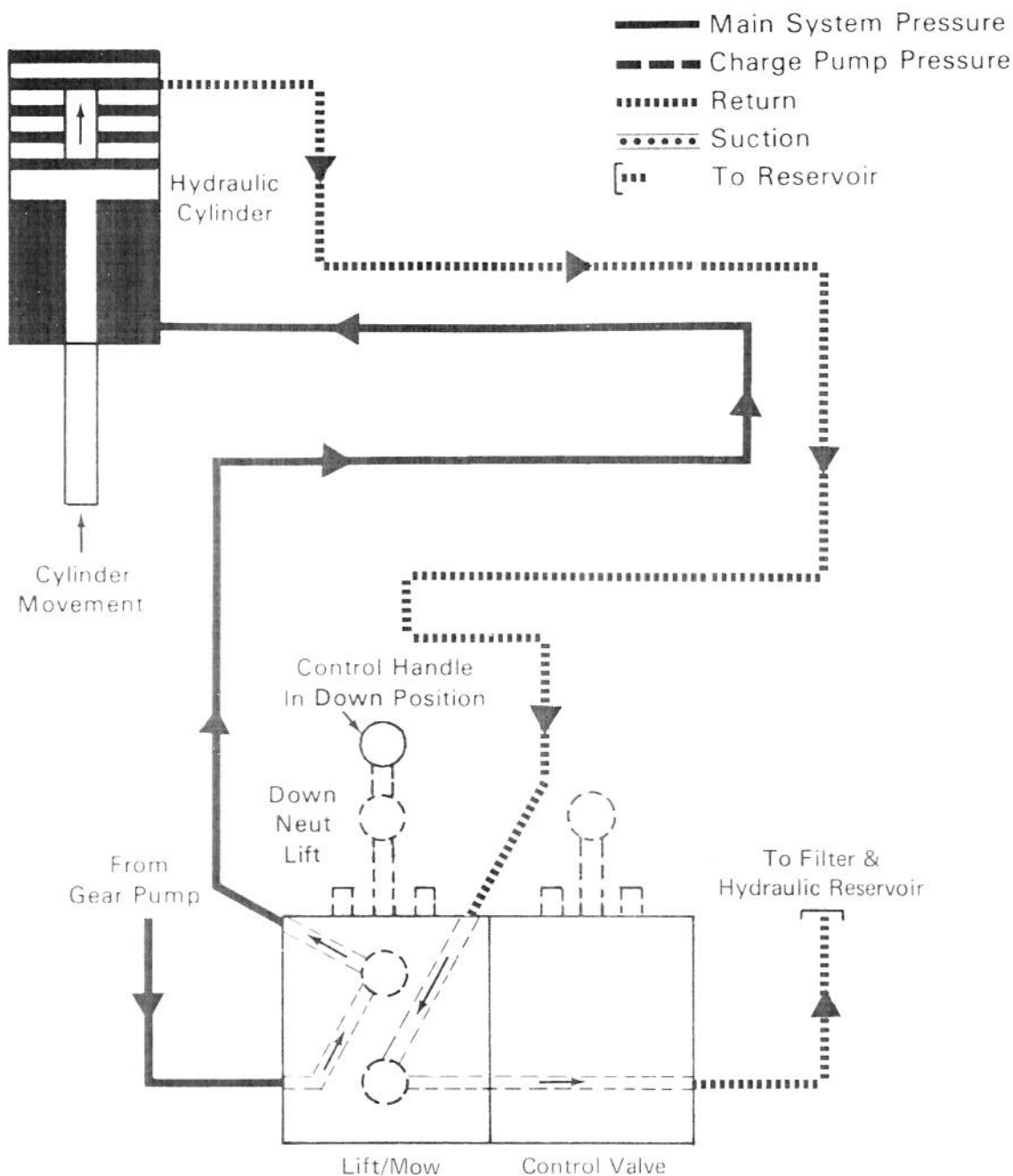

MAINTENANCE

Next function of mowing operation. Control handle is placed in MOW position after cutting units are fully down. High pressure oil from gear pump flows through lift/mow control valve and by-pass control valve to each cutting unit gear motor, driving reels in forward direction.

Low pressure oil returns from motors to filter and hydraulic tank. A third line from each motor allows a minimal amount of oil to drain through cooler and back to the tank.

HYDRAULIC CIRCUIT— REEL DRIVE
MOWING OPERATION

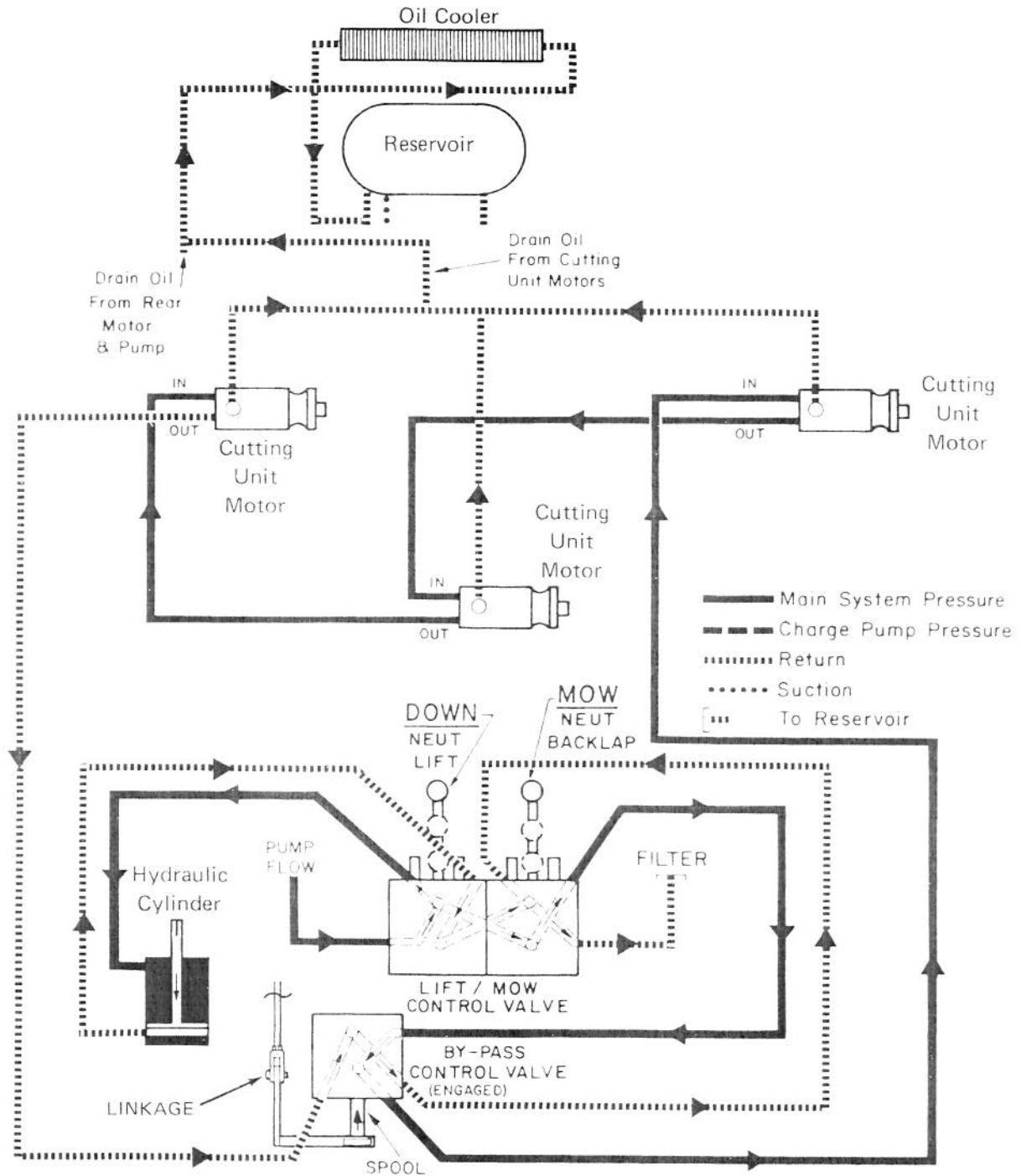

MAINTENANCE

Last function to perform after reels have been shut off. Placing control handle in LIFT position allows high pressure oil to flow through lift/mow control valve to hydraulic cylinder. Oil pressure forces piston and rod outward and raises cutting units. Oil

on opposite of piston returns through control valve to filter and hydraulic reservoir.

A 2000 P.S.I. (13 790 kPa) relief valve in control valve opens if control lever is held in LIFT position after units are fully raised.

HYDRAULIC CIRCUIT — REEL DRIVE
RAISING CUTTING UNITS

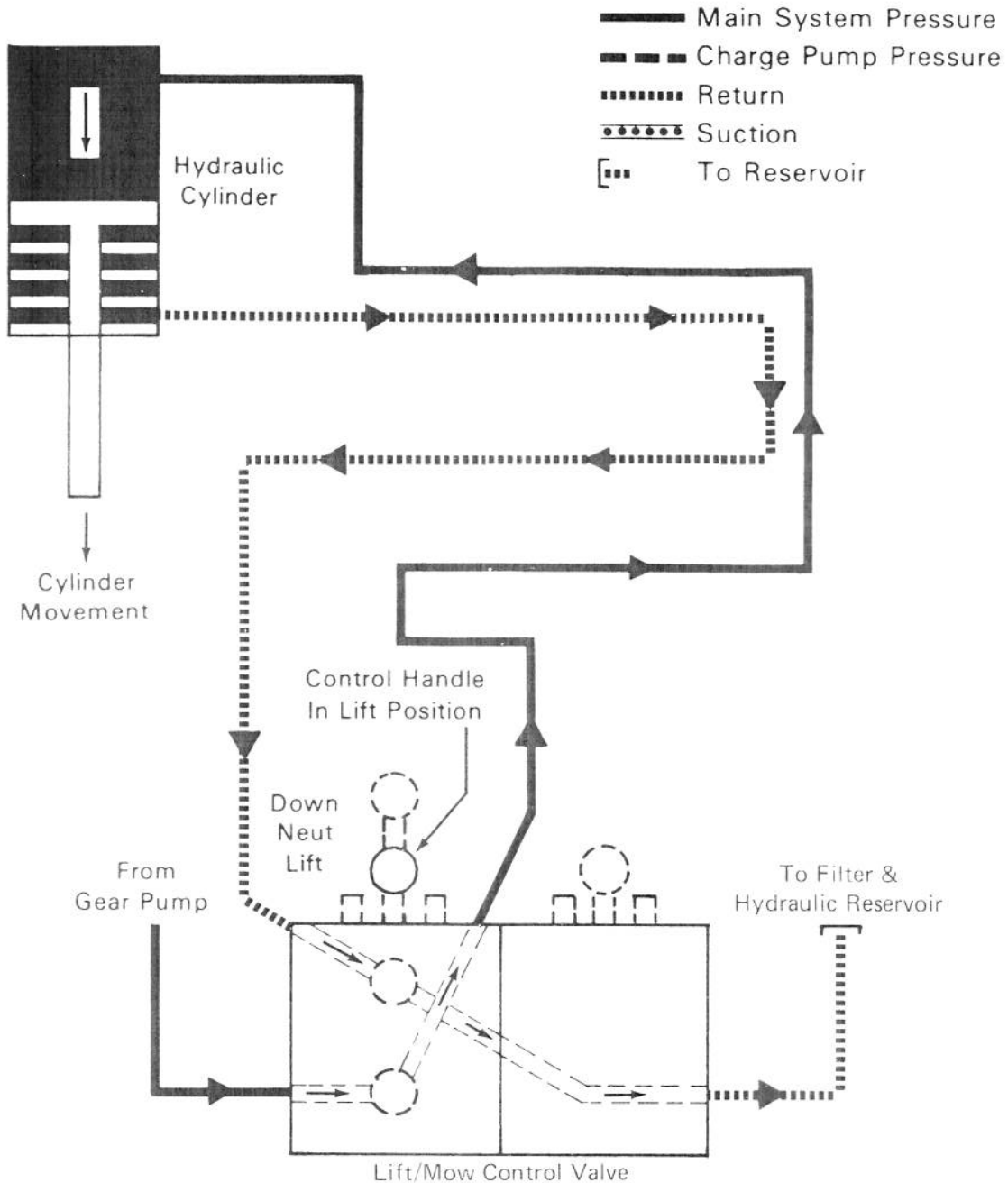

MAINTENANCE

A by-pass control valve, which is a safety device, is incorporated into the reel drive system. Should the operator fail to move the control handle out of MOW position before raising the cutting handle units, the oil which normally flows to the cutting unit motors will be by-passed to the hydraulic reservoir, preventing the reels from turning.

The valve spool is controlled by mechanical linkage connected to the lift arm. The by-pass control valve spool remains released (OUT), causing the oil to by-pass, until the cutting units are fully lowered and the cylinder rod fully retracted.

HYDRAULIC CIRCUIT— REEL LIFT VALVE IN LIFT POSITION, CUTTING UNITS LOWERED, REEL DRIVE VALVE IN MOW POSITION, REEL MOTOR BY-PASS VALVE RELEASED

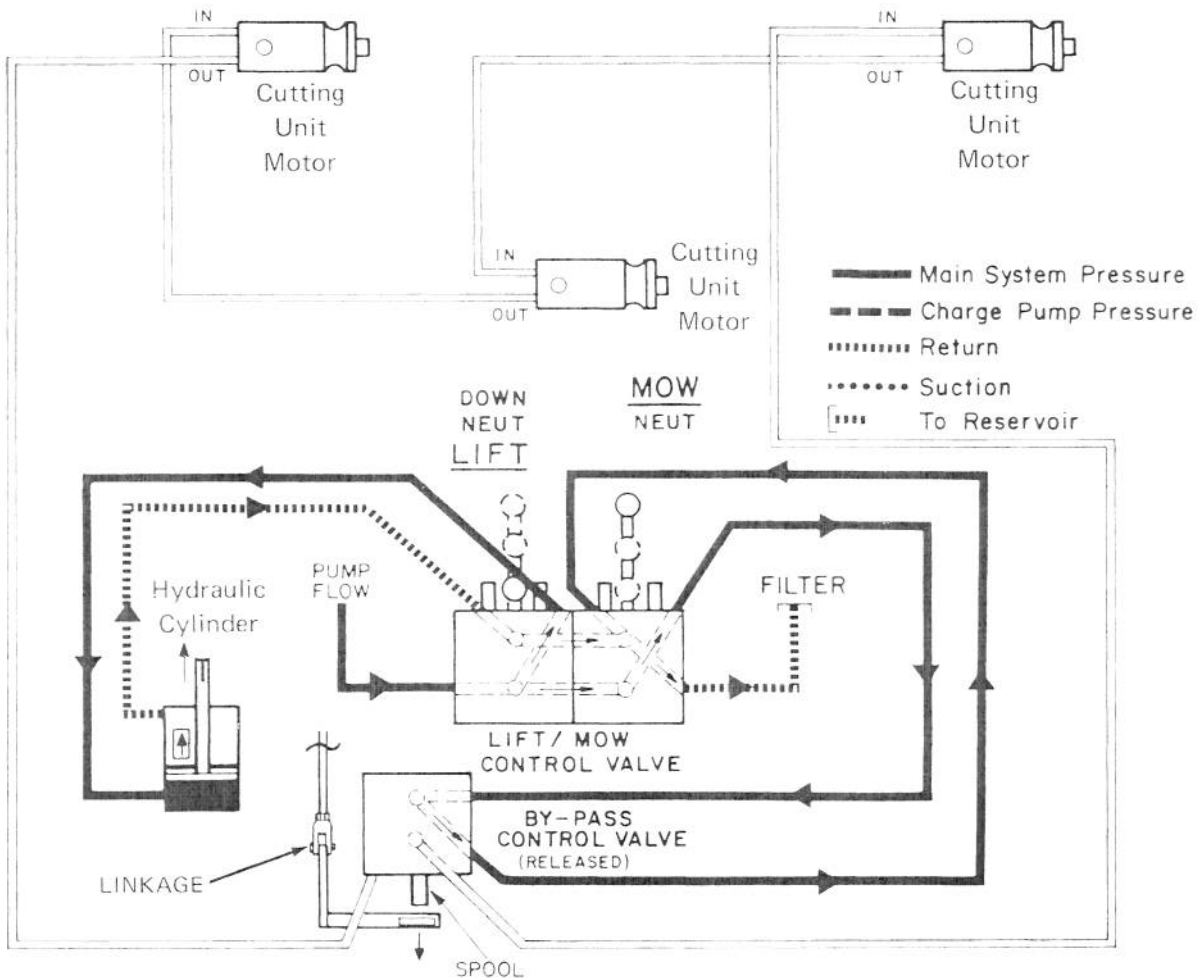

MAINTENANCE

Maintenance function to sharpen reel and bedknife. Performed with cutting units in fully down position only. Refer to Backlap Operation, page 30. Control handle is moved rearward to BACKLAP position to allow high pressure oil from gear pump to

pass through lift/mow control valve and by-pass control valve to cutting unit motors. Flow is in reverse direction of flow during mowing operation causing cutting unit motors and reels to rotate in reverse direction.

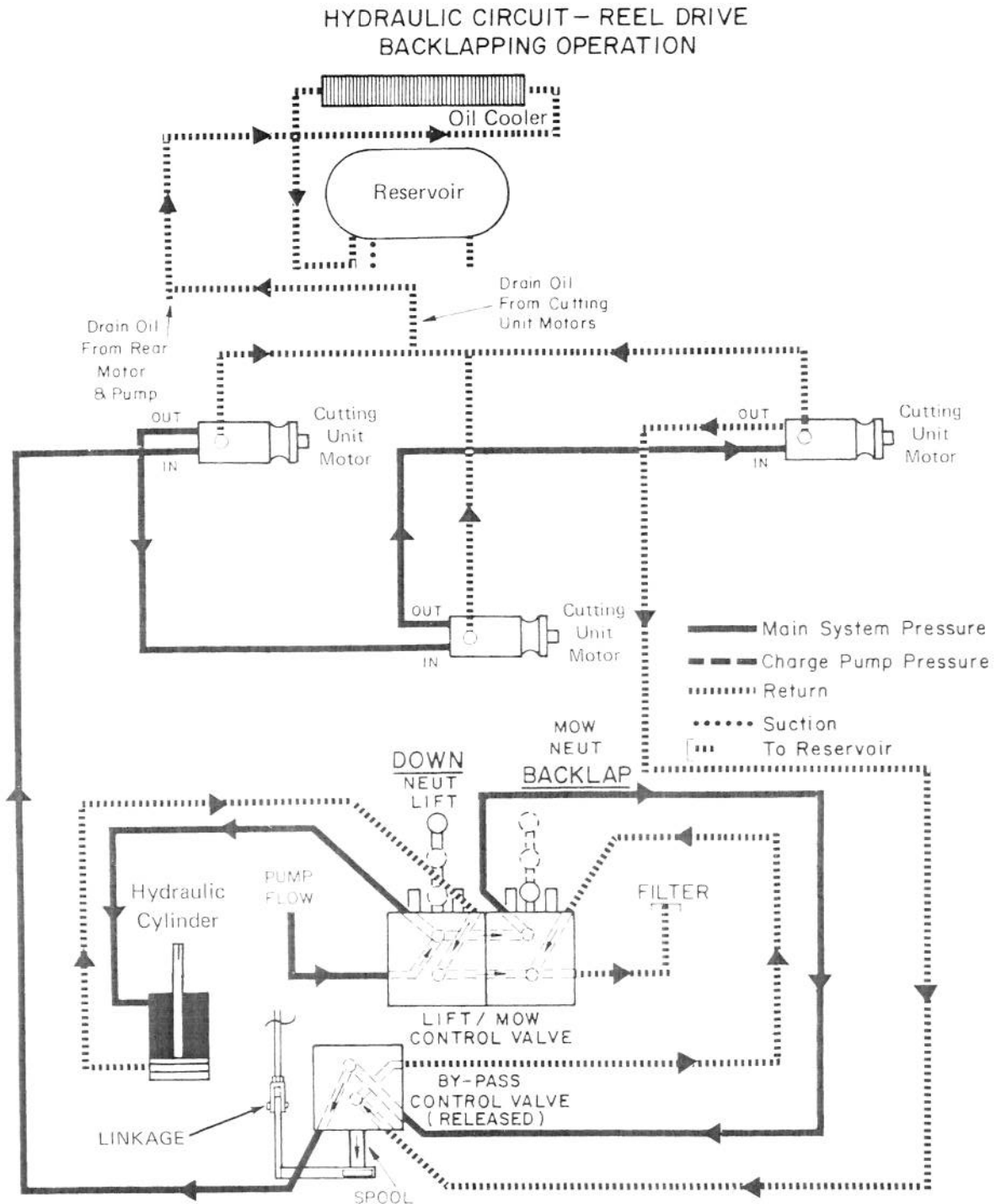

MAINTENANCE

SLOW OR NO TRACTION IN EITHER DIRECTION

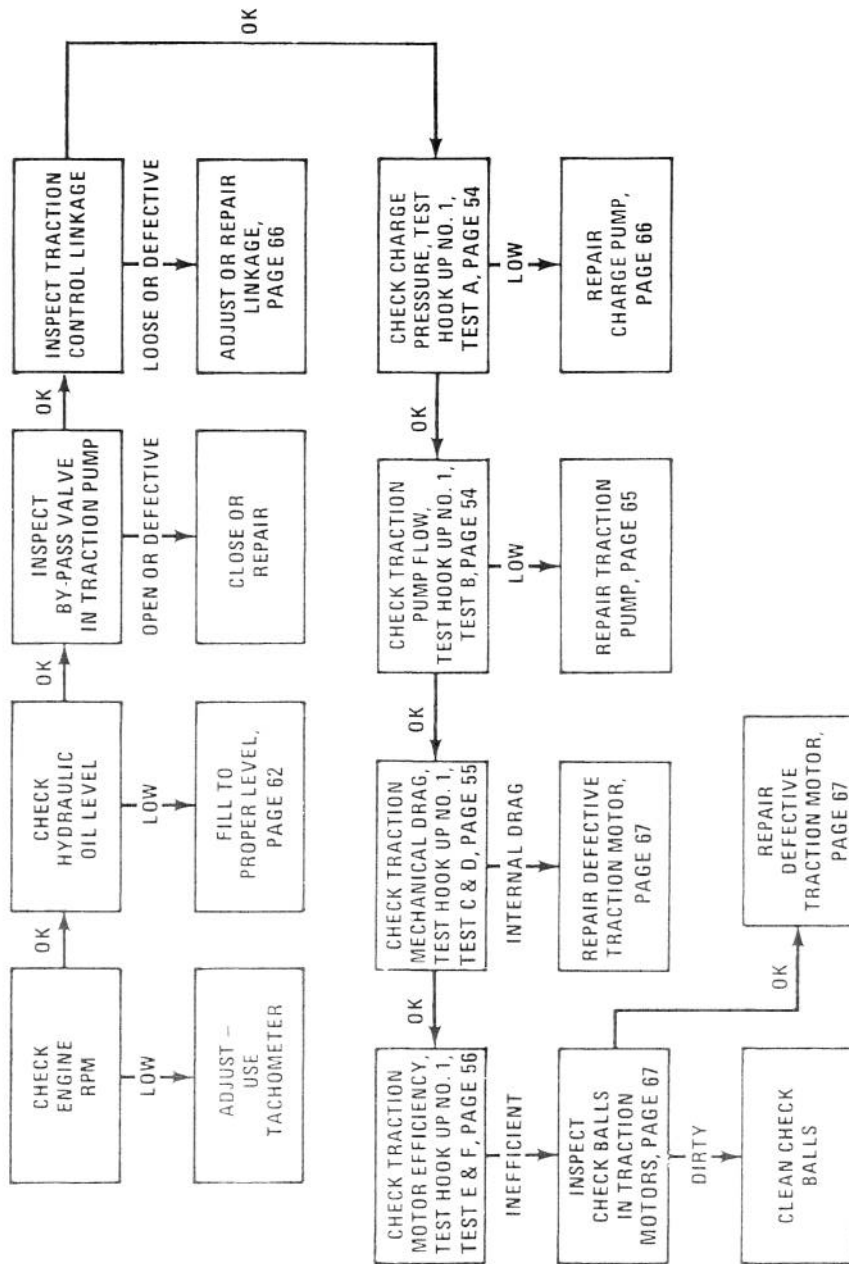

MAINTENANCE

TRACTION SYSTEM OPERATES IN ONLY ONE DIRECTION

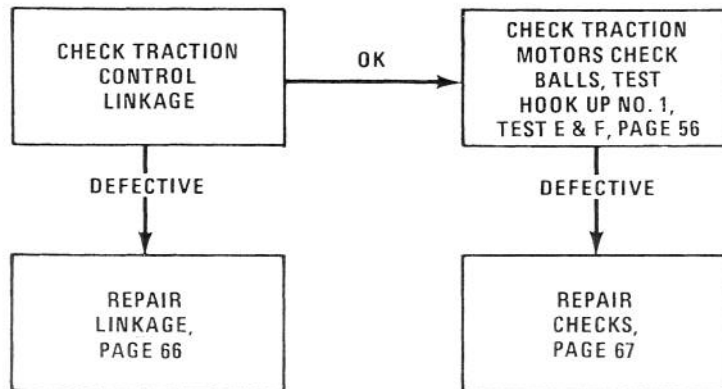

CUTTING UNIT MOTORS BLOW SEALS

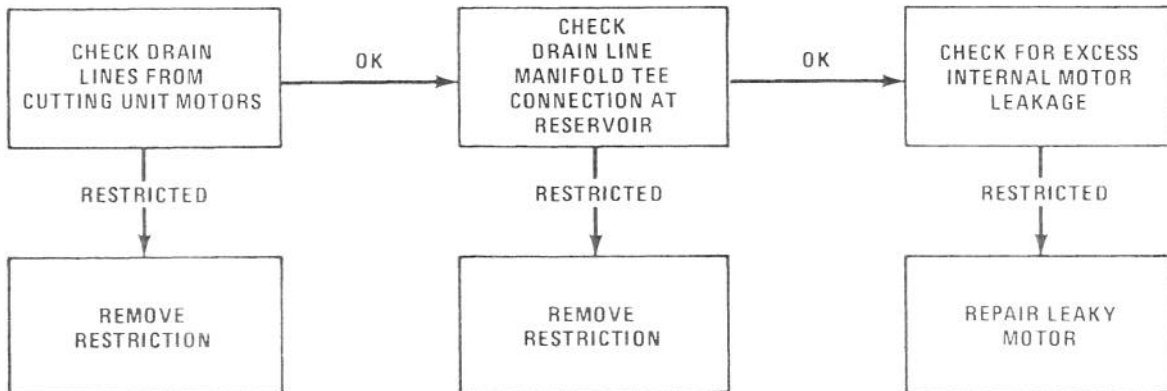

MAINTENANCE

ALL REELS SLOW OR WON'T TURN

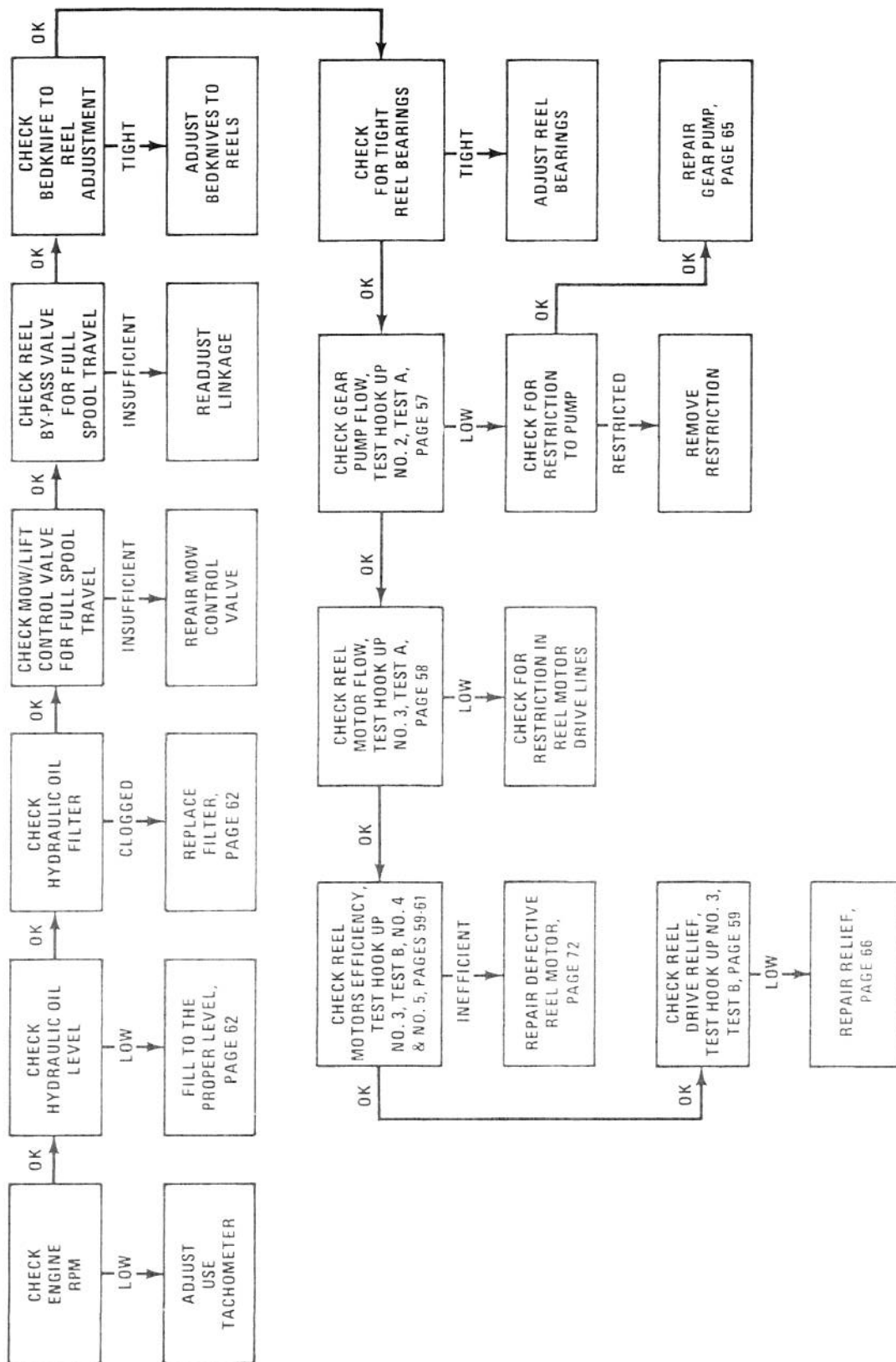

MAINTENANCE

ONE CUTTING UNIT RUNNING SLOW

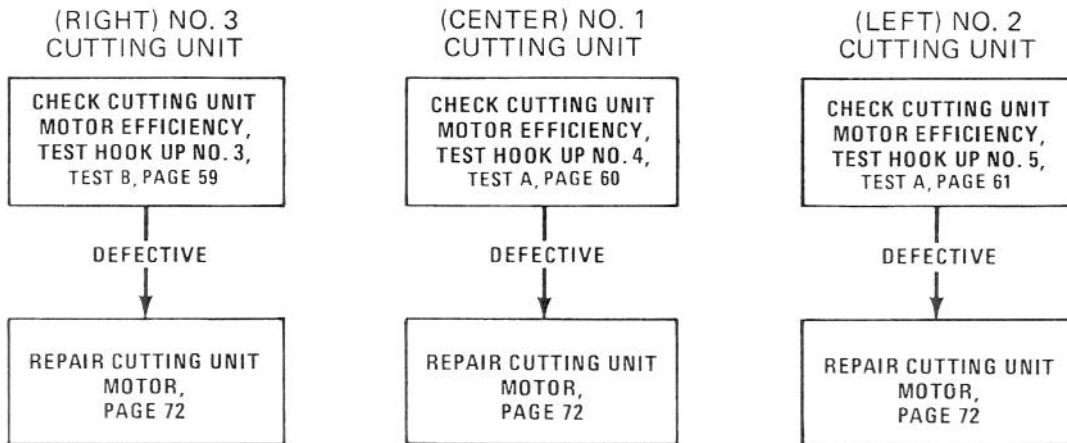

CUTTING UNITS DROP WHILE IN TRANSPORT

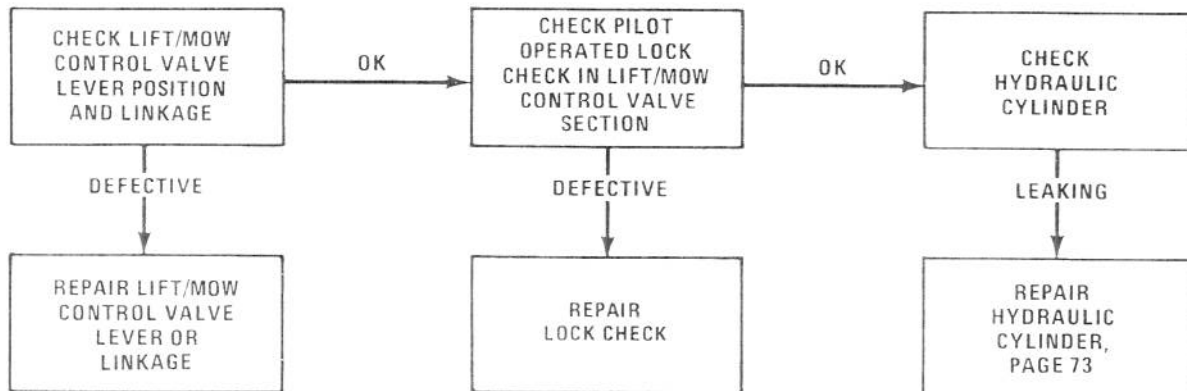

CUTTING UNITS RAISE WHILE MOWING

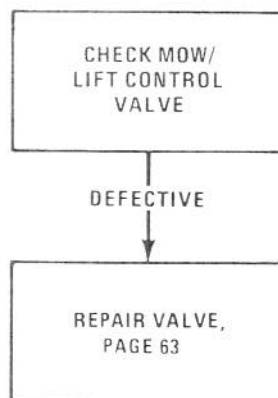

MAINTENANCE

PRINCIPLES OF HYDRAULIC TEST EQUIPMENT

Hydraulic test equipment allows you to observe the amount of oil flow and oil pressure in a circuit under various conditions.

Hydraulic testers can vary significantly in size, make up, accuracy and cost; but, to perform its function, a tester requires the following components:

1. **INLET HOSE:** Hose connected from system circuit to inlet side of hydraulic tester. (Fig. 65).
2. **LOAD VALVE:** If required, upon turning the valve to restrict flow, a simulated working load is created in the circuit. (Fig. 65).
3. **LOW PRESSURE GAUGE:** Low range gauge to provide accurate reading at low pressure. This gauge has a protector valve which cuts out if pressure exceeds the normal range for the gauge. The cut out pressure is adjustable. (Fig. 65).
4. **HIGH PRESSURE GAUGE:** High range gauge to accommodate pressure beyond the capacity of the low pressure gauge. (Fig. 65).
5. **FLOW METER:** This meter measures actual oil flow in the operation circuit. This reading is given in gallons per minute, GPM (Fig. 65).

6. **OUTLET HOSE:** Hose from outlet side of hydraulic tester connected to system circuit (Fig. 65).

In summary, a basic circuit requires a reservoir, pump, relief valve, control valve and cylinder or motor (Fig. 66). One or more components within a hydraulic system may become damaged or inefficient. It can be very time consuming and costly to start changing components, guessing and hoping that you have picked the right one. This is the reason a hydraulic tester is a necessity when diagnosing problems on equipment that have sophisticated hydraulic systems.

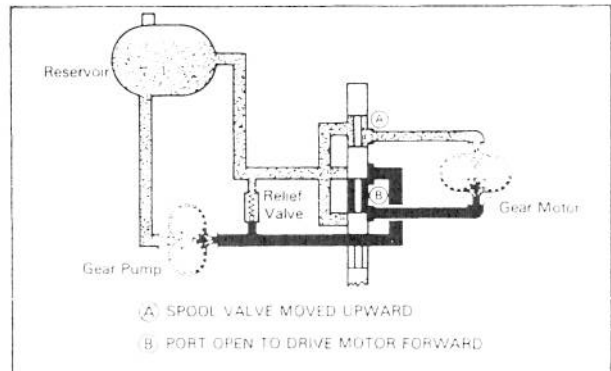

Figure 66

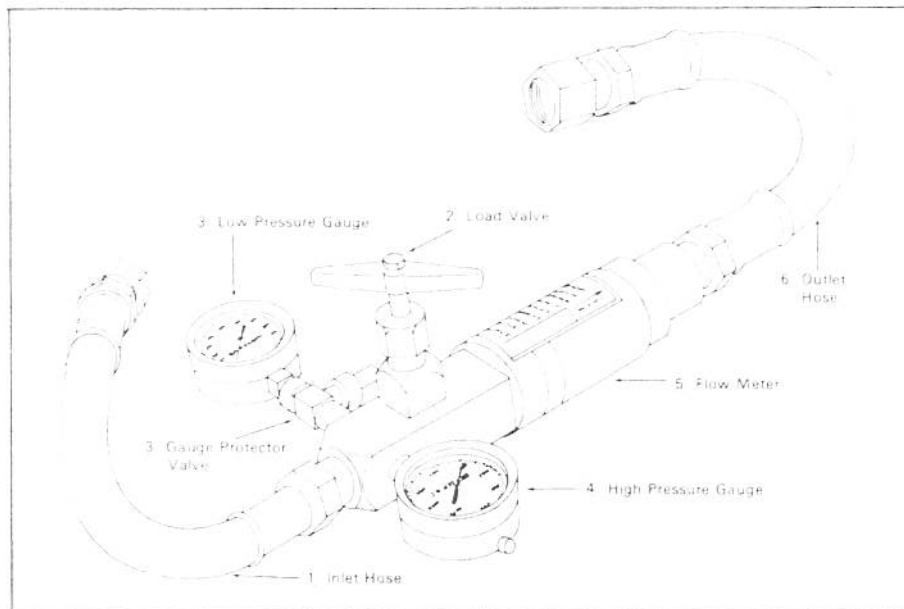

Figure 65

MAINTENANCE

It should be pointed out that all obvious areas such as oil supply, filter, binding, linkage, loose control valve spool linkage or improper adjustments be checked before assuming that a hydraulic component is the source of a hydraulic problem. In most cases, when a problem develops on a hydraulically operated piece of equipment, it is

not the hydraulic component that is defective, but an external factor controlling it.

The following illustrations will point out the typical hook ups and tests that can be made in a basic circuit. Sample Problem Symptom: ground speed on a machine is abnormally slow.

Note: The following examples are to be used only as guidelines. Not as test procedures for the TURF PRO 84. See following pages for actual procedures and specifications.

SAMPLE HOOK UP NO. 1 (Fig. 67)

TEST A – PUMP FLOW

Connect the tester in series with the pump output circuit, we can then measure the pump output to insure that the oil flow is adequate to drive the motor at the proper speed.

TEST B – MOTOR MECHANICAL BINDING

Using the same conditions as Test A, we can observe the pressure gauge and see that it doesn't require excessive pressure to rotate the free running motor.

TEST C – RELIEF PRESSURE

When the motor is locked, to prevent rotation, all the flow from the pump will be forced over the relief valve. Noting the pressure on the gauge, we can determine if the relief is regulating within the recommended spec.

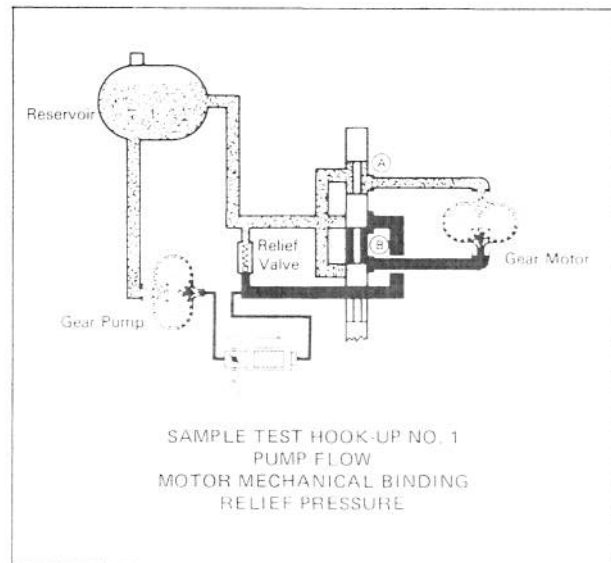

Figure 67

SAMPLE HOOK UP NO. 2 (Fig. 68)

TEST A – FLOW TO MOTOR

With the tester in series between the spool valve and the motor, we can measure the flow to compare this reading with the reading previously taken in Hook Up No. 1, Test A. If this reading is now lower, it indicates a problem in the spool valve. The valve is probably improperly positioned, restricting some flow from the pump to the motor.

TEST B – MOTOR EFFICIENCY

If the motor is locked, preventing rotation, there should be no flow through the motor, and this will be indicated on the flow meter. If there is flow and it is beyond an acceptable level, it is an indication the motor is inefficient.

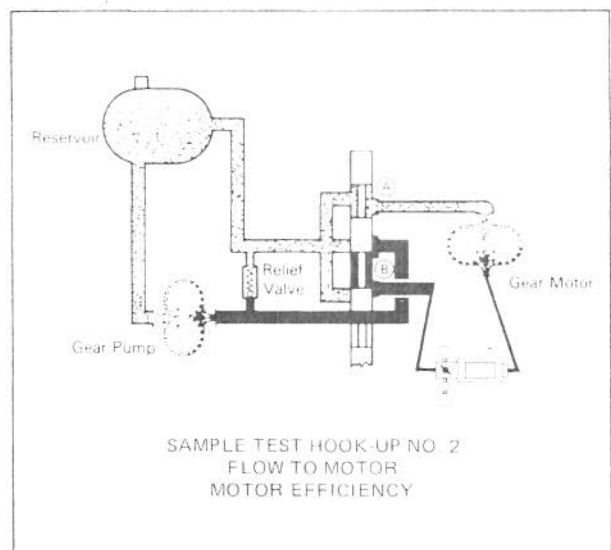

Figure 68

MAINTENANCE

When using a hydraulic tester, always check the following before starting the engine on the equipment:

1. To prevent damage to tester or components, inlet & outlet hose must be properly connected; not reversed.
2. To minimize the possibility of damaging components, open load valve on tester completely by turning counterclockwise.

WARNING: Most pumps used on Turf equipment are positive displacement type. If their flow output is completely restricted or cut off, damage to components could occur.

3. Fittings must be tight.

4. Position all lines and connected tester hoses such that rotating components will not make contact thereby resulting in hose damage (Fig. 69).

5. All hydraulic tests should be made with the hydraulic oil at operating temperature.

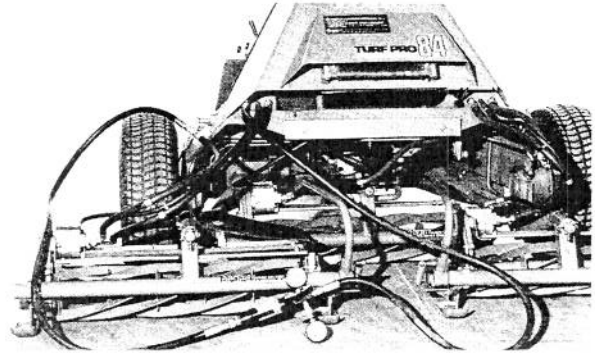

Figure 69

MAINTENANCE

TEST HOOK UP NO. 1

TEST	A. Charge Pump Pressure	C. Wheel Motors Mechanical Drag
	B. Traction Pump Flow	D. Wheel Motors Efficiency

TESTER CONNECTION:

Tester in series between traction pump outlet and tee connection (Fig. 70).

(Flow Control Open)

CAUTION: Keep everyone clear from the front of unit during traction system tests.

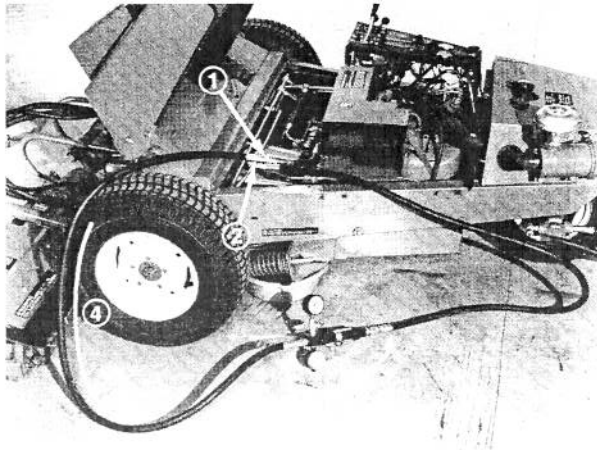
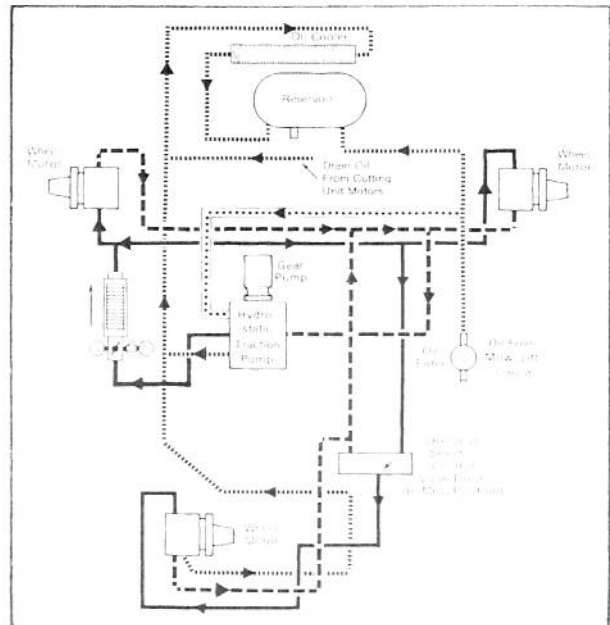

Figure 70

1. Traction pump outlet
2. Tee fitting
3. Flow control open
4. Direction of flow



TEST A: CHARGE PUMP PRESSURE PROCEDURE

Traction pedal must be in neutral.

Eng. RPM 3000 ± 100 .

Hydraulic oil at operating temperature.

TESTER READINGS

Pressure not less than 60 PSI (414 kPa).

If pressure is less than 60 PSI, check inlet line to charge pump for restriction.

If no restriction, remove charge pump and repair as necessary.

If pressure exceeds 60 PSI (414 kPa), proceed to Test B.

TEST B: TRACTION PUMP FLOW PROCEDURE

Block up rear traction wheel off floor.

Apply front brakes and engage park lock.

Remove wire connector from seat interlock switch and bridge connector terminals together with a jumper wire (Fig. 71).

Overdrive control valve in mow (down) position.

MAINTENANCE

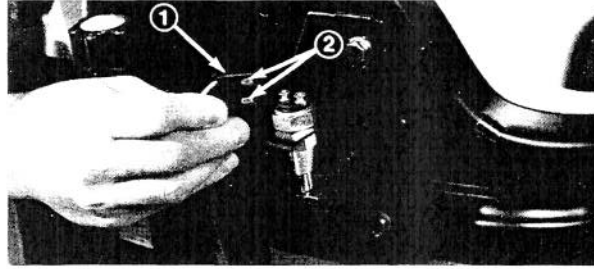

Figure 71

1. Seat switch connector 2. Bridge connections

Eng. RPM 3000± 100.

Hydraulic oil at operating temperature.

While watching flow and pressure gauges, slowly press traction pedal into forward until 13 GPM (0.82 l/s) is obtained.

If pressure rises above 1000 PSI (6 895 kPa) proceed to TEST C. If pressure remains below 1000 PSI (6 895 kPa), use flow control valve to obtain 1500 PSI (10 342 kPa), at 13 GPM (0.82 l/s). (If 13 GPM [0.82 l/s] cannot be obtained, it may be necessary to adjust traction pedal linkage).

TESTER READINGS

13 GPM at 1500 PSI (0.82 l/s at 10 342 kPa).

If below 13 GPM (0.82 l/s) or 1500 PSI (10 342 kPa), check traction pump inlet line for restriction. If not restricted, remove pump and repair as necessary.

If readings are within specifications, proceed to Test C.

TEST C: REAR WHEEL MOTOR MECHANICAL DRAG

PROCEDURE

Use the same procedure as Test A in Test Hook Up No. 1
(Flow Control Open)

TESTER READINGS

At 13 GPM (0.82 l/s), pressure not to exceed 1000 PSI (6 895 kPa).

If pressure rises above 1000 PSI (6 895 kPa), check:

1. That overdrive control valve is in mow (down) position.
2. For restriction in lines to or from rear wheel motor.
3. For internal wheel motor drag. If internal drag, remove wheel motor and repair as necessary; refer to Motor Removal and Servicing, page 66, 67.
4. If readings are correct, proceed to Test D.

TEST D: FRONT WHEEL MOTORS MECHANICAL DRAG

PROCEDURE

Set rear wheel back on floor.

Raise left front wheel off floor.

Remove wire connector from seat interlock switch and bridge connector terminals together with a jumper wire (Fig. 71).

Disconnect left wheel brake rod.

Apply front brake and engage park lock.

MAINTENANCE

Overdrive control valve in high (up) position.

Eng. RPM 3000± 100.

Hydraulic oil at operating temperature.

While watching pressure gauges, slowly press traction pedal into forward position until 13 GPM (0.82 l/s) is obtained.

TESTER READINGS

Not to exceed 1000 PSI at 13 GPM (6 895 kpa at 0.82 l/s).

If higher reading is obtained, check pressure lines to or from wheel motor that is being checked. If no restriction, remove wheel and check brake for binding. If brake is free, remove wheel motor and repair as necessary. Lower left wheel, raise the right wheel and check the right front wheel motor in the same manner.

NOTE: Reconnect brake rod after each test is completed. If readings are correct, proceed to Test E.

TEST E: REAR WHEEL MOTOR EFFICIENCY

PROCEDURE

All wheels on floor.

Apply front brakes and engage park lock.

Block front of all wheels.

Overdrive control valve in mow (down) position.

Eng. RPM 3000± 100.

Hydraulic oil at operating temperature.

While watching pressure gauges, slowly press traction pedal into forward position until 1500 PSI (10 342 kPa) is obtained, read flow gauge. If rear wheel spins before 1500 PSI (10 342 kPa) is obtained, have person sit on back of unit.

TESTER READINGS

Not more than 2 GPM flow at 1500 PSI (0.126 l/s at 10 342 kPa).

If flow reading is higher than 2 GPM (0.126 l/s), raise overdrive control valve (high) and repeat test.

If flow reading is still excessive, check front wheel motors ball checks; refer to Motor Removal and Servicing, page 66, 67. If ball checks are O.K. proceed to Test F.

If flow reading drops to acceptable level, check rear wheel motor ball checks.

If ball checks are O.K. remove rear motor and repair as necessary.

TEST F: FRONT WHEEL MOTOR EFFICIENCY

PROCEDURE

Disconnect pressure line on front of left side wheel motor.

Cap fitting on motor and insert plug into pressure line (Fig. 72).

Apply front brakes and engage park lock.

Overdrive control valve in high (up) position.

Eng. RPM 3000± 100.

Hydraulic oil at operating temperature.

While watching pressure gauges, slowly press traction pedal into forward position until 1500 PSI (10 342 kPa) is obtained, read flow gauge.

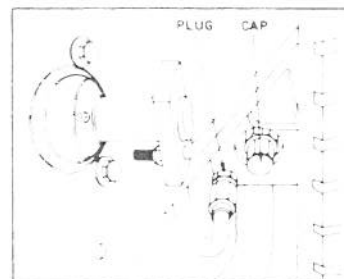

Figure 72

MAINTENANCE

TESTER READINGS

Not more than 2 GPM flow at 1500 PSI (0.126 l/s at 10 342 kPa).

If flow reading is more than 2 GPM (0.126 l/s), remove right side wheel motor and repair as necessary.

If flow reading goes down to acceptable level, remove lift side wheel motor and repair as necessary.

TEST HOOK UP NO. 2

TEST	Gear Pump Flow – Cutting Units
------	--------------------------------

TESTER CONNECTION:



Tester in series between large hose from gear pump and lift/mow control valve (Fig. 73). Move cutting unit lever into mow position when making tester connection to prevent oil flow from line.

(Flow Control Open)

Remove wire connector from seat interlock switch and bridge connector terminals with a jumper wire (Fig. 71).

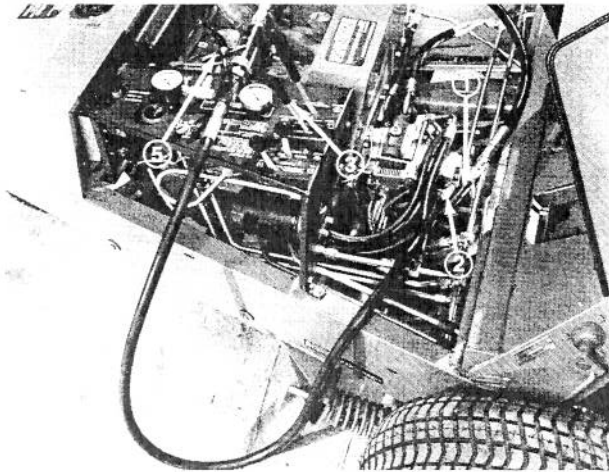
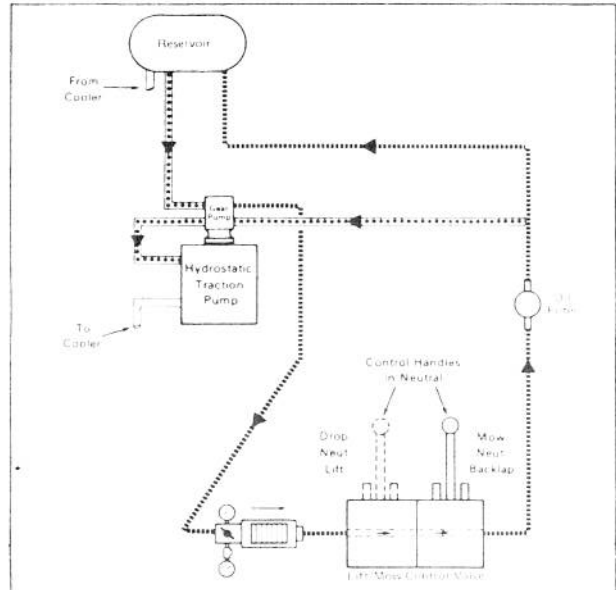

Figure 73

1. Gear pump to valve line
2. Gear pump fitting
3. Cutting unit lever – move to MOW position before connecting tester lines
4. Direction of flow
5. Flow control open



TEST A: GEAR PUMP FLOW

PROCEDURE

Before starting engine, place cutting unit lever in off position.

Eng. RPM 3000± 100.

Hydraulic oil at operating temperature.

While watching pressure gauges, slowly close flow control valve until 2000 PSI (13 790 kPa) is obtained, read flow gauge.

TESTER READINGS

GPM Flow – Not less than 9 GPM at 2000 PSI (0.562 l/s at 13 790 kPa).

If flow is lower than 9 GPM (0.562 l/s), check at pump inlet for restriction in oil supply.

If no restriction, remove and repair pump as necessary.

If readings are correct, proceed to Test Hook Up No. 3.

MAINTENANCE

TEST HOOK UP NO. 3

TEST	A. Cutting Unit Motor Flow B. Cutting Unit Relief Setting No. 3 Cutting Unit Motor Efficiency
------	---

TESTER CONNECTION:

Tester in series between high pressure inlet line fitting on frame and line which runs to No. 3 cutting unit reel motor (Fig. 74).

(Flow Control Open)

CAUTION: Keep everyone clear of reels during cutting unit system tests.

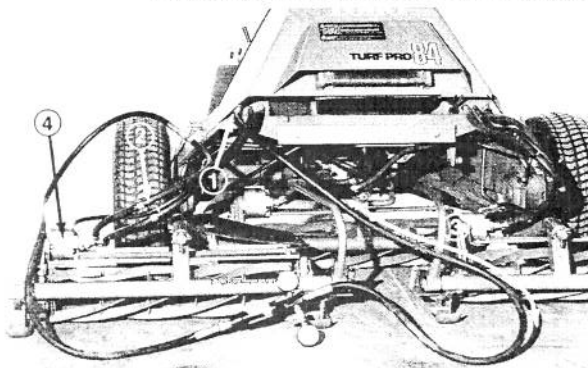
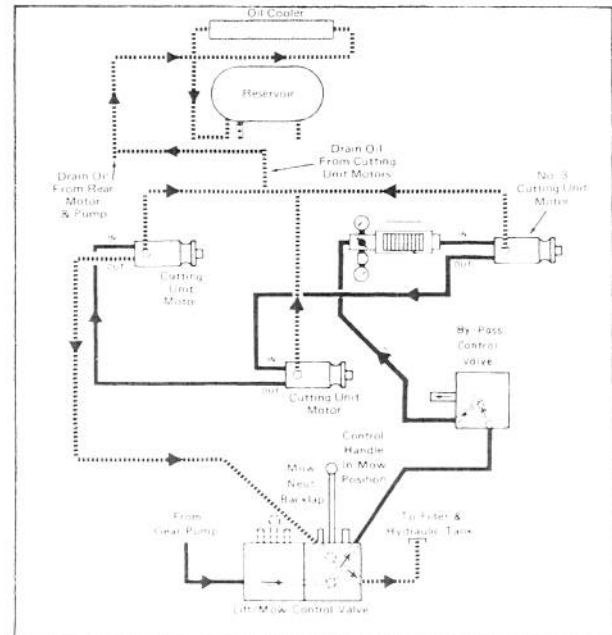

Figure 74

1. Frame inlet line fitting
2. Line to No. 3 cutting unit motor
3. Direction of flow
4. No. 3 cutting unit motor



TEST A: CUTTING UNIT MOTOR FLOW

PROCEDURE

With engine off, back off bedknives from reels.

Be sure everything is clear of reels.

Eng. RPM 3000± 100.

Hydraulic oil at operating temperature.

While watching flow and pressure gauges, slowly engage "mow" lever, read pressure and flow gauges.

TESTER READINGS

GPM Flow – Not less than 9 GPM (0.562 l/s) at pressure no higher than 1100 PSI (7 584 kPa).

If pressure is higher than 1100 PSI (7 584 kPa), check all cutting units for mechanical drag or for restriction in cutting unit motor lines.

If flow is lower than 9 GPM (0.562 l/s), but pressure is within spec's, check "mow" control valve for full spool travel.

MAINTENANCE

TEST B: CUTTING UNIT RELIEF PRESSURE SETTING AND NO. 3 CUTTING UNIT MOTOR EFFICIENCY (RIGHT SIDE)

PROCEDURE

With engine off, place a block of wood securely between reel blades and support brace on the front of No. 3 cutting unit.

Eng. RPM 3000 ± 100 .

Hydraulic oil at operating temperature.

While watching flow and pressure gauges, slowly engage "mow" lever and read flow and pressure gauges.

Take readings with wood block at all three cutting units.

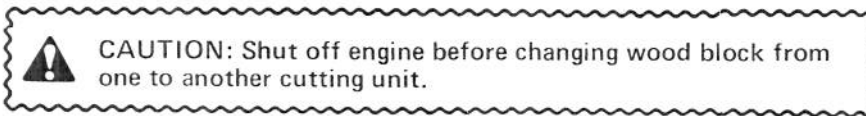

TESTER READINGS

GPM Flow – Not more than 1.5 GPM (0.088 l/s) at minimum 1500 PSI (10 342 kPa) or maximum 2500 PSI (17 237 kPa).

If pressure reading is less than 1500 PSI (10 342 kPa) or more than 2500 PSI (17 237 kPa), remove relief valve from mow/lift control valve and repair as necessary.

If flow reading is higher than 1.5 GPM (0.088 l/s), remove No. 3 cutting unit motor and repair as necessary.

MAINTENANCE

TEST HOOK UP NO. 4

TEST	No. 1 Cutting Unit Motor Efficiency (Center)
------	--

TESTER CONNECTION:

Tester in series between hose from No. 3 cutting unit motor and No. 1 cutting unit motor at fitting on frame (Fig. 75).

(Flow Control Open)

CAUTION: Keep everyone clear of reels during cutting unit system tests.

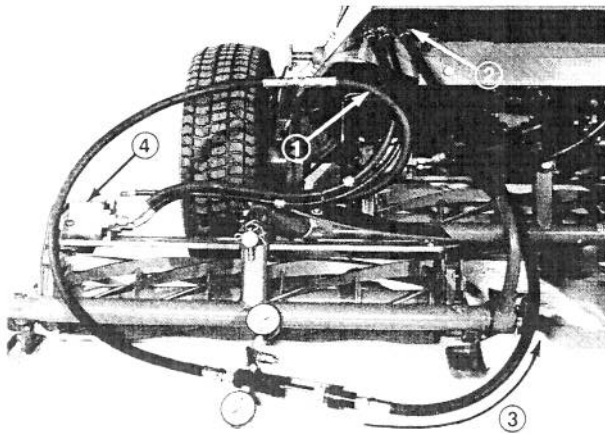
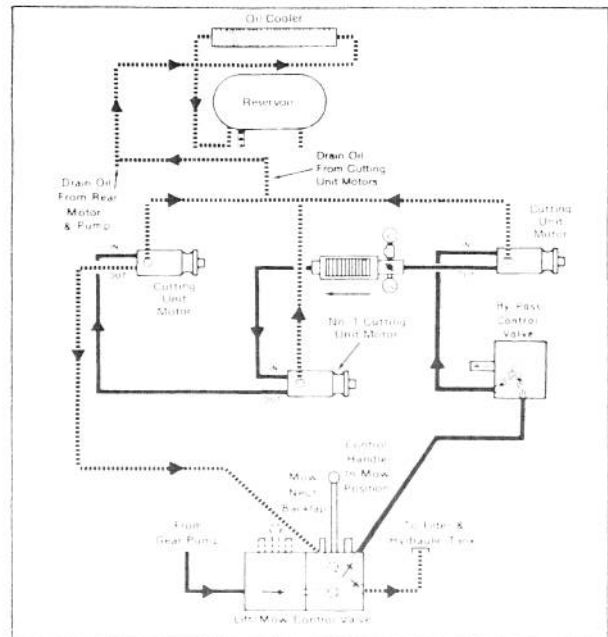

Figure 75

1. Line from No. 3 cutting unit motor
2. To No. 1 cutting unit motor
3. Direction of flow
4. No. 3 cutting unit motor



TEST A: NO. 1 CUTTING UNIT MOTOR EFFICIENCY

PROCEDURE

Use the same procedure as Test Hook Up No. 3, Test B, except with the engine off, place a block of wood in No. 1 cutting unit reel.

TESTER READINGS

GPM Flow – Not more than 1.5 GPM (0.088 l/s) at relief pressure.

If flow reading is higher than 1.5 GPM (0.088 l/s), remove No. 1 cutting unit motor and repair as necessary.

MAINTENANCE

TEST HOOK UP NO. 5

TEST	No. 2 Cutting Unit Motor Efficiency (Left Side)
------	---

TESTER CONNECTION:

Tester in series between hose from No. 1 cutting unit motor and No. 2 cutting unit motor at fitting on frame (Fig. 76).

(Flow Control Open)



CAUTION: Keep everyone clear of reels during cutting unit system tests.

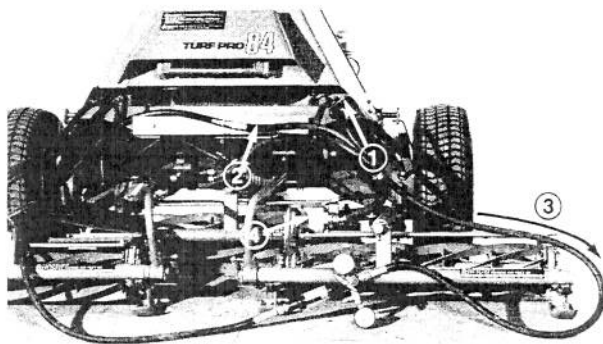
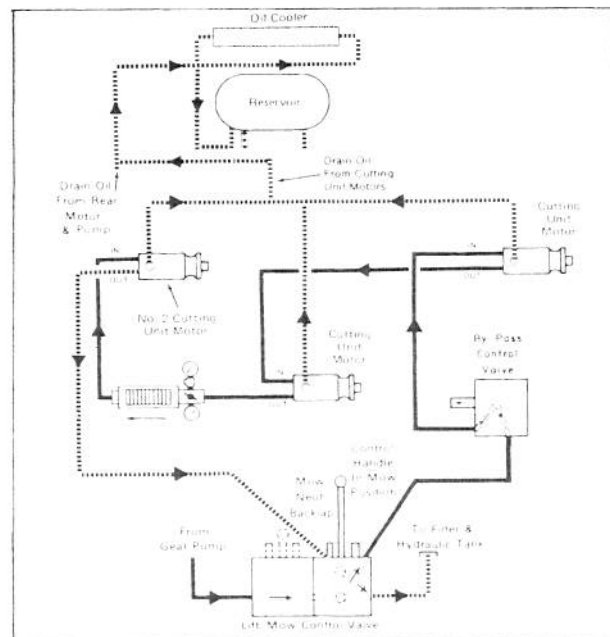

Figure 76

1. From No. 1 cutting unit motor
2. Line to No. 2 cutting unit motor
3. Direction of flow
4. No. 2 cutting unit motor



TEST A: NO. 2 CUTTING UNIT MOTOR EFFICIENCY

PROCEDURE

Use the same procedure as Test Hook Up No. 3, Test B, except with engine off, place block of wood in No. 2 cutting unit reel.

TESTER READINGS

GPM Flow – Not more than 1.5 GPM (0.088 l/s) at relief pressure.

If flow reading is higher than 1.5 GPM (0.088 l/s), remove No. 2 cutting unit motor and repair as necessary.

MAINTENANCE

SERVICING THE HYDRAULIC SYSTEM

DAILY CHECKS: Check the hydraulic fluid level daily. Replenish with SAE 10W-30 or 10W-40 engine oil as necessary. Also, check daily for leaks, chafed or otherwise damaged hoses and make sure there are no kinks, sharp bends or twists in any flexible line. Repair or replace as necessary. (Fig.81).

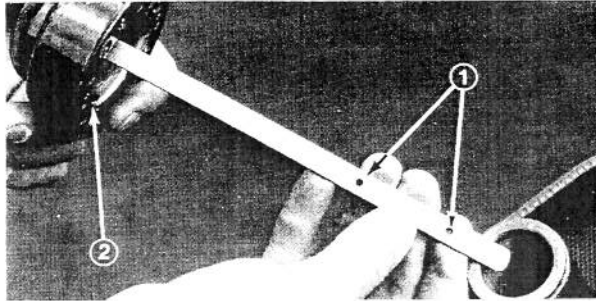

Figure 77

1. Oil level between holes 2. Breather cap

GENERAL MAINTENANCE: Before installing a new or rebuilt pump, valve, or hydraulic motor, charge it with 10W-40 oil. Replace any felt strips under the reservoir straps which may become damaged or out of place.

FLEXIBLE HYDRAULIC HOSES: There are twenty (20) flexible hydraulic hoses on the Turf Pro 84. Toro records show, that, on an average, approximately one third of all Turf Pro 84's will experience a hose failure within the first 3 years operation. This most often occurs because of damage, but could also be as a result of weather, chemicals, or storage conditions where the machine is stored in an extremely warm environment. History also shows that two-thirds (2/3) of the hose problems in the field are associated with the nine (9) cutting unit motor hoses. These hoses are not as well protected from the elements, such as the sun, chemicals or from damage.

These types of operating conditions cause flexible hydraulic hoses to deteriorate. History indicates, if a preventive maintenance replacement program is not followed, approximately fifty percent of all Turf Pro 84's will experience a hose failure during the fourth year of operation, one additional failure the fifth year, etc.

DRAINING RESERVOIR

Tools Required: Screwdriver, Drain Pan.

Every 2000 hours, drain and replace the oil in the hydraulic reservoir. Use the following procedures:

1. Place a drain pan under the reservoir and re-

move suction hose. Completely drain the reservoir and replace the hose (Fig. 78).

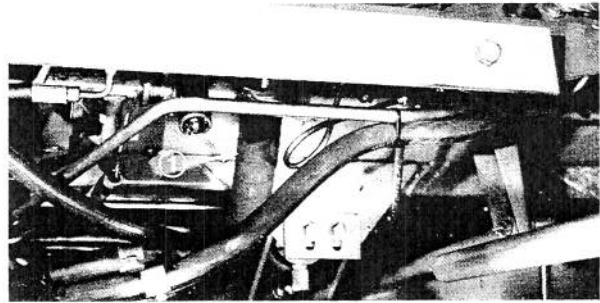

Figure 78

1. Remove hose to drain reservoir

Note: Only the reservoir needs to be drained.

IMPORTANT: Do not operate the Turf Pro 84 while the fluid is being drained; damage to the hydraulic system may result.

2. Refill the reservoir with a good grade of SAE 10W-30 or 10W-40 engine oil until level is up to the lower mark on dipstick (Fig. 77).
3. Start the machine and run it at idle for 3 to 5 minutes to circulate the oil and remove any air trapped in the system. Stop the machine and re-check the oil level.

HYDRAULIC FILTER

Tools Required: Drain Pan, Toro Part No. 2410-45 Caplug.

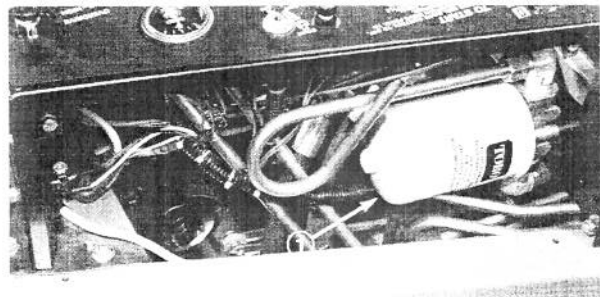

Figure 79

1. Hydraulic oil filter

Replace the filter initially at 10 hours and every 250 hours thereafter. Use the following procedures:

1. Start engine, lower cutting units and stop engine, remove breather cap from hydraulic reservoir, remove filler screen and install Toro Part No. 2410-45 Caplug into hole in reservoir (Fig. 80). Plug will prevent excessive oil loss.
2. Open engine cowl, place a drain pan under the filter and remove and discard the filter.

MAINTENANCE

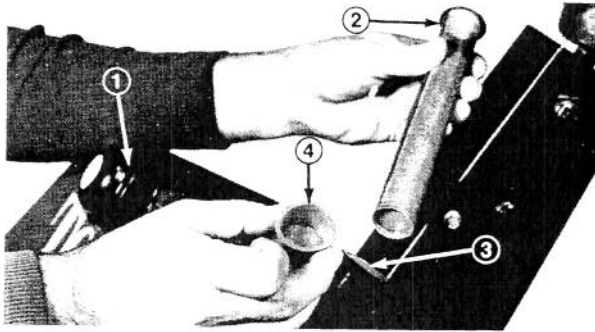

Figure 80

- | | |
|-------------------------------|------------------|
| 1. Breather/dipstick assembly | 3. Oil fill hole |
| 2. Screen | 4. Caplug |

3. Lubricate the sealing gasket of filter with SAE 10W-40 oil, hand turn until gasket contacts filter head and tighten three quarter turns further. Filter should now be sealed.

4. Remove caplug, install screen and breather cap, start the engine and check for leaks.

5. Check fluid in hydraulic system. Replenish as necessary.

REMOVING AND REPLACING MOW/LIFT HYDRAULIC CONTROL VALVE

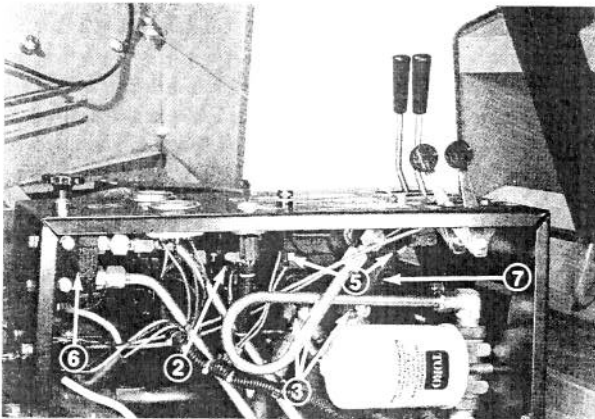

Figure 81

- | | |
|-------------------------------------|-------------------------------------|
| 1. Valve control levers | 5. Locknuts (3) |
| 2. Interlock switch connector | 6. Overdrive selector control valve |
| 3. Hydraulic lines and fittings (6) | |
| 4. Valve mounting capscrews (3) | 7. Mow/lift control valve |

1. Drain the reservoir; refer to Draining Reservoir, page 62.

2. Unlatch and open engine cowl, remove the valve levers and disconnect interlock switch connector.

3. Disconnect and cap lines and fittings from valve assembly, remove capscrews and locknuts securing valve and remove valve.

4. Repair as necessary and reassemble in reverse order.

5. Test interlock switch when valve is reassembled; refer to Mow-Backlap Switch Test, page 74.

REPAIRING OVERDRIVE SELECTOR CONTROL VALVE

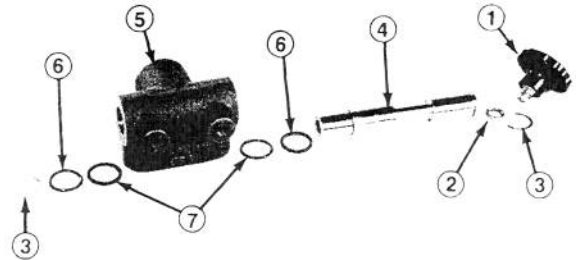

Figure 82

- | | |
|-------------------|-------------------|
| 1. Knob | 5. Housing |
| 2. Lockwasher | 6. Backup washers |
| 3. Retainer rings | 7. O-ring seals |
| 4. Spool | |

Tools Required: Drain Pan, 1/2 inch, 7/8 inch Wrenches, Pliers.

1. Open engine cowl, place drain pan under valve, remove knob, hydraulic lines from valve, and fittings (Fig. 81 and 82).

2. Remove retainer rings, slide spool from housing, replace backup washers and O-ring seals and reassemble.

3. Reinstall valve to machine.

REMOVING AND REPLACING GEAR PUMP

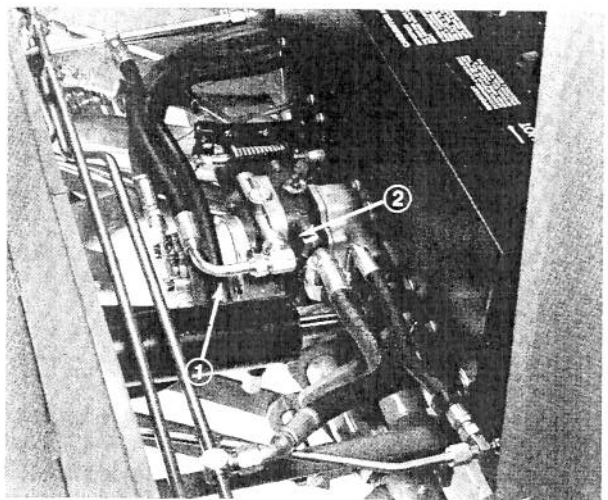

Figure 83

- | |
|---------------------------|
| 1. Cutting unit gear pump |
| 2. Traction pump |

MAINTENANCE

Tools Required: Drain Pan, Torque Wrench, Screwdriver, 9/16 inch Socket Wrench, 7/8, 15/16, 1, 1-1/4 inch Wrenches.

1. Drain reservoir; refer to Draining Reservoir, page 62.
2. Raise engine cowl and remove floor plate.
3. Remove lines and fittings from cutting unit gear pump and install caplugs over line and fitting ends.
4. Remove capscrews securing the cutting unit gear pump to traction pump and remove gear pump from machine.
5. Disassemble gear pump and repair as necessary; refer to Gear Pump Servicing below.
6. Charge pump with oil and reinstall to machine. Torque mounting capscrews to 220-290 in.-lb (25 - 33 N·m).
7. Refill reservoir to proper level, start machine, check for leaks and test for proper operation.

CUTTING UNIT GEAR PUMP SERVICING

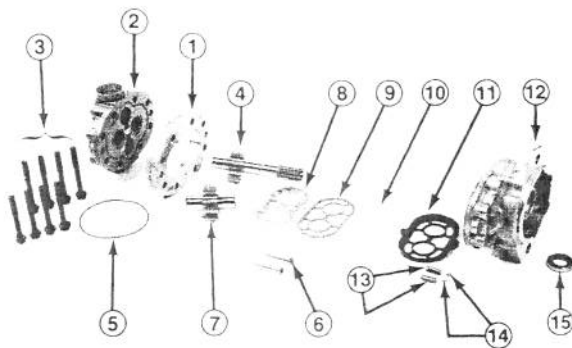

Figure 84

- | | | |
|------------------------|------------------------|--------------------|
| 1. Body | 6. Dowel pins | 11. Diaphragm seal |
| 2. Back plate | 7. Idler gear assembly | 12. Front plate |
| 3. Capscrews | 8. Diaphragm | 13. Springs |
| 4. Drive gear assembly | 9. Back up gasket | 14. Balls |
| 5. O-ring seal | 10. Protector gasket | 15. Shaft seal |

Tools Required: 3/8 inch 12 point Socket Wrench, Seal Protectors, Torque Wrench, Plastic Head Hammer.

Disassembly:

1. Clean outside of pump with solvent and dry thoroughly. Scribe marks on body and front and back plate to assure parts will be assembled in same manner.

Note: Replacement bodies or plates must be marked in identical location.

2. Secure unit with light clamping pressure in vise, shaft end down and remove capscrews. Note that capscrews are different lengths.

3. Remove pump from vise. Hold pump in hands and bump shaft against wooden block to separate front plate from back plate. Body will remain with either plate.

4. To separate body from plate it remains with, place drive gear in bearing and tap protruding end with plastic hammer.

5. Remove O-ring seal from back plate assembly.

6. Pry diaphragm from front plate with sharp tool.

7. Remove springs (2) and steel balls (2) from front plate.

8. Lift back-up and protector gaskets from front plate.

9. Lift diaphragm seal from front plate.

10. Remove shaft seal from front plate.

11. Discard diaphragm, back-up and protector gaskets, O-ring seal and diaphragm and shaft seals. Wash and thoroughly dry all remaining parts. Remove key from shaft. Remove nicks and burrs from all parts with emery cloth.

12. Inspect drive gear shaft for broken keyway and both drive gear and idler gear shafts for rough surfaces and excessive wear. Make sure snap rings are in grooves on each side of gears.

13. If shafts measure less than 0.6850 in. (17.399 mm) in bearing area, replace the gear assembly.

Note: One gear assembly may be replaced separately. Shafts and gears are available only as assemblies.

14. Inspect gear face for scoring and excessive wear and measure gear width. Replace assembly if face is heavily scored or width of gear is less than 0.636 in. (16.1544 mm).

15. If gears are still useable, but edges of gear teeth are sharp, break edges with emery cloth.

16. Measure I.D. of bushings, in front and back plates. If I.D. exceeds 0.691 in. (17.551 mm), replace plate.

17. Check depth of score marks on face of back plate. If depth exceeds 0.0015 in. (0.0381 mm), replace plate.

18. Inspect body. If gear pocket I.D. wear exceeds 1.719 in. (43.662 mm), replace body.

MAINTENANCE

Assembly:

1. Discard diaphragm, back-up gasket, diaphragm seal, protector gasket, O-ring seal and shaft seal and replace with new parts.
2. Using a dull tool, tuck diaphragm seal into grooves in front plate with open part of "V" section down.
3. Press protector gasket and backup gasket into diaphragm seal.
4. Drop steel balls into seats and place springs over balls.
5. Place diaphragm, bronze face up, on top of back-up gasket and ensure entire diaphragm fits inside raised rim of diaphragm seal.
6. Dip gear assemblies into clean oil, slip into front plate bushings and install dowel pins into body.
7. Apply a thin coat of heavy grease to both milled faces of body and slip body over gears onto front plate. Half moon port cavities in body must face away from front plate. Small drilled hole in one of the cavities must be on pressure side of pump.
8. Install O-ring seal in groove in back plate, slide back plate over gear shafts until dowel pins are engaged, install capscrews and draw up evenly to 23 ft-lb (31 N·m).
9. Oil shaft seal liberally. Install seal over drive gear shaft, using either a seal protector or carefully working seal over shaft to prevent cutting seal lip. Seat seal by tapping it in with plastic hammer.
10. Rotate pump by hand or with pliers. Pump will rotate with small amount of drag, but should turn freely after short period.
11. Mount pump on machine and operate for two minutes at one quarter engine throttle setting, then two minutes at one-half throttle, then two minutes at full throttle. Stop engine and check for leaks. If no leaks are evident, test run machine under load for five minutes and check again for leakage.

REMOVING AND REPLACING TRACTION AND CUTTING UNIT PUMP ASSEMBLY (Fig. 85)

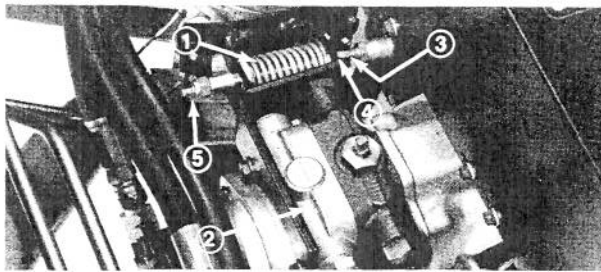

Figure 85

- | | |
|--|------------------|
| 1. Traction lever equalizer assembly | 4. Equalizer rod |
| 2. Cutting unit and traction pump assembly | 5. Locknut |
| 3. Jam nut | |

Tools Required: Drain Pan, Torque Wrench, Screwdriver, 9/16, 7/8, 15/16, 1, 1-1/4 inch Wrenches, Hammer, Drift Punch.

1. Drain reservoir; refer to Draining Reservoir, page 62.
2. Lift engine cowl and remove floor plate.
3. Remove and cap lines and fittings from cutting unit and traction pump.
4. Disassemble and remove traction lever and equalizer assembly from traction pump (Fig. 85).
5. Remove capscrews securing traction pump to engine and remove traction and cutting unit pump.
6. Make necessary repairs. Refer to Cutting Unit Pump Servicing, page 64, and Servicing Traction Pump Assembly, page 65.
7. Reassemble; grease traction pump shaft, fill pump with fresh, clean oil, install O-ring seal and mount to machine. Torque mounting capscrews to 240-320 in.-lb (29 - 33 N·m) and refill reservoir to proper level.
8. Install pump lever and equalizer assembly and adjust traction linkage for neutral position; refer to Adjusting Traction Linkage, page 66.

SERVICING TRACTION PUMP ASSEMBLY (Fig. 86)

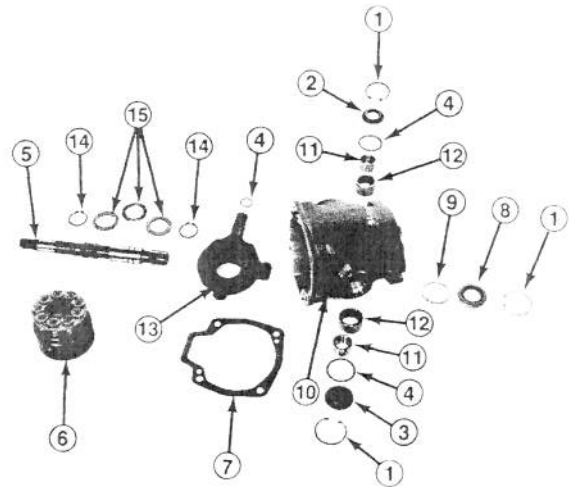

Figure 86

- | | |
|--------------------------|----------------------------------|
| 1. Retaining rings | 9. Washer |
| 2. Trunnion cover | 10. Housing |
| 3. Sleeve cover | 11. Inner races |
| 4. O-ring seals | 12. Needle bearings |
| 5. Drive shaft | 13. Trunnion shaft and cam plate |
| 6. Piston block assembly | 14. Driveshaft retaining rings |
| 7. Gasket | 15. Thrust bearing assembly |
| 8. Shaft seal | |

MAINTENANCE

Replacing Trunnion Shaft Seals

Tools Required: Drain Pan, Snap Ring Pliers, Hammer, Drift Pin Punch, 9/16, 3/4 inch Wrenches.

1. Remove traction pump lever assembly if leak is on lever side.
2. Place drain pan under pump and remove retaining ring and trunnion cover on pump lever side; sleeve cover on opposite side.
3. Remove O-ring seals.
4. Oil replacement O-ring seals and assemble in reverse order.

Note: Pump must be removed if leak is caused by faulty trunnion shaft bearings or inner O-ring seal on trunnion shaft; refer to Traction Pump Removal, page 65 and Servicing Piston Block and Cam Plate Assembly, page 66.

CHARGE PUMP ASSEMBLY REMOVAL AND REPLACEMENT

Tools Required: Screwdriver, Snap Ring Pliers, Pliers, 1/2 inch Socket Wrench, Soft-faced Hammer, Torque Wrench.

1. Thoroughly clean outside of pump and clamp shaft end in a soft-jawed vise with the body up. Remove four (4) capscrews from pump body and separate charge pump adaptor assembly from back plate assembly with soft-faced hammer.
2. Remove coupler shaft and geroler assembly and inspect for excessive wear on geroler assembly and mating face of adaptor. If excessive wear is evident on any of the components, replace all three.
3. Inspect coupler shaft. If wear is evident, determine in which housing end was installed and replace both shaft and housing.
4. Replace all O-ring seals and other seals to insure against possible leakage. Check valves are pressed into back plate and can be removed to replace seals; order Toro seal repair kit to insure proper seals are installed.
5. Install bracket and capscrews into proper holes in pump body and torque to 17-20 ft-lb (23-27 N·m).

SERVICING PISTON BLOCK AND CAM PLATE ASSEMBLY (Fig. 90)

Tools Required: Snap Ring Pliers, Seal Protector, 1/2 inch Socket Wrench, Torque Wrench, Soft-faced Hammer, Arbor Press, Bearing Installation Tool.

1. Remove four (4) capscrews from pump body

and separate housing assembly from back plate with a soft-faced hammer.

2. Remove drive shaft and turn back plate side of housing down to allow piston block assembly to drop out of housing in assembled form.
3. Inspect piston and block assembly. Replace if excessive wear is evident. Also inspect mating face in cam plate. Replace cam plate, if necessary.
4. To remove cam plate, remove retaining rings for trunnion shaft, trunnion and sleeve cover and both inner races. Move trunnion shaft end of cam plate further out of housing to allow opposite shaft to clear hole in housing, lift end opposite to trunnion shaft and slide trunnion shaft and cam plate out of housing.
5. Replace bearings if cam plate needs replacing or if bearings are worn.
6. Remove retaining rings and thrust bearing assembly from drive shaft. Replace, if necessary.
7. Reassemble in reverse order. Replace all seals and gaskets to insure against leakage. Use a seal protector while installing drive shaft to protect shaft seal. Install bracket and capscrews securing assembly together in proper holes in pump body and torque to 17-20 ft-lb (23-27 N·m).

ADJUSTING TRACTION LINKAGE

Tools Required: 4 x 4 in. (10 x 10 cm) Wheel Blocks, Jack, Jack Stands, 9/16 inch Open End Wrench.

1. Place blocks in front of front wheels, lock parking brake and jack rear wheel off floor. Support rear of unit with jack stands.
2. Start engine, move overdrive control valve selector to DOWN position.
3. Advance throttle to maximum throttle setting. There should be no rear wheel rotation when traction pedal is in neutral (centered) or when traction pedal is released from maximum position in both forward and reverse positions.
4. If wheel is rotating, stop engine, lift engine cowl, remove floor plate, lower cowl and restart engine. Loosen jam nut, and turn equalizer rod clockwise if wheel is rotating rearward, counter-clockwise if rotating forward until rotation stops (Fig. 85). Retighten jam nut.
5. Replace floor plate, remove blocks, jack stands, lower machine and test drive to check adjustment.

REMOVAL AND REPLACEMENT OF REAR WHEEL MOTOR

Tools Required: Wheel Blocks, Jack, Jack Stands, Drain Pan, Wheel Puller, Screwdriver, Pliers,

MAINTENANCE

11/16 inch Socket Wrench, 3/4, 7/8, 1, 1-1/2 inch wrenches, Torque Wrench.

1. Lock parking brake, block front wheels, place jack under frame on wheel side and raise rear of machine. Use jack stands to support machine.
2. Remove rear wheel and hub assembly, place pan under machine and remove and cap hydraulic lines (Fig. 87).

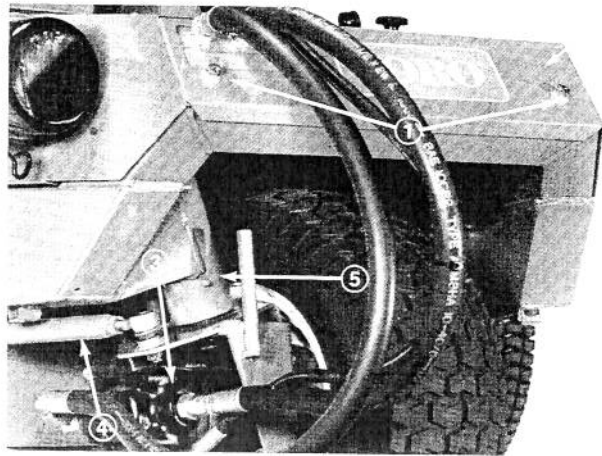

Figure 87

- | | |
|-----------------------------|---------------------|
| 1. Cover mounting capscrews | 4. Steering tube |
| 2. Rear cover | 5. Spindle assembly |
| 3. Wheel motor | |

3. Remove motor from spindle housing.

4. Repair or replace motor and reassemble in reverse order; refer to Front and Rear Wheel Motor Servicing, page 67. Fill motor with fresh, clean oil before installing. Torque wheel hub nut to 125

ft-lb (170 N·m) minimum. Tighten nut further to align holes for cotter pin. DO NOT BACK NUT OFF.

REMOVAL AND REPLACEMENT OF FRONT WHEEL MOTOR

Tools Required: Jack, Wheel Blocks, 5/8, 7/8, 1, 1-1/2 inch Wrenches, Torque Wrench, Drain Pan.

1. Remove wheel, wheel hub and brake assembly; refer to Removal of Brake Assembly, page 27.
2. Place drain pan under motor, remove and cap hydraulic lines and fittings.
3. Remove mounting bolts for motor and remove motor from frame.
4. Repair or replace motor and reassemble in reverse order; refer to Front and Rear Wheel Motor Servicing, page 67. Fill motor with fresh, clean oil before installing. Torque wheel hub nut to 125 ft-lb (170 N·m). Tighten nut further to align holes for cotter pin. DO NOT BACK NUT OFF.

FRONT AND REAR WHEEL MOTOR SERVICING

Tools Required: 9/16 inch Socket Wrench, 3/16 inch Allen Wrench, Small Screwdriver, Torque Wrench, Seal Protector, Alignment Studs (2) (Fig. 88), Petroleum Jelly.

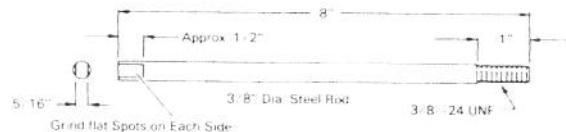

Figure 88

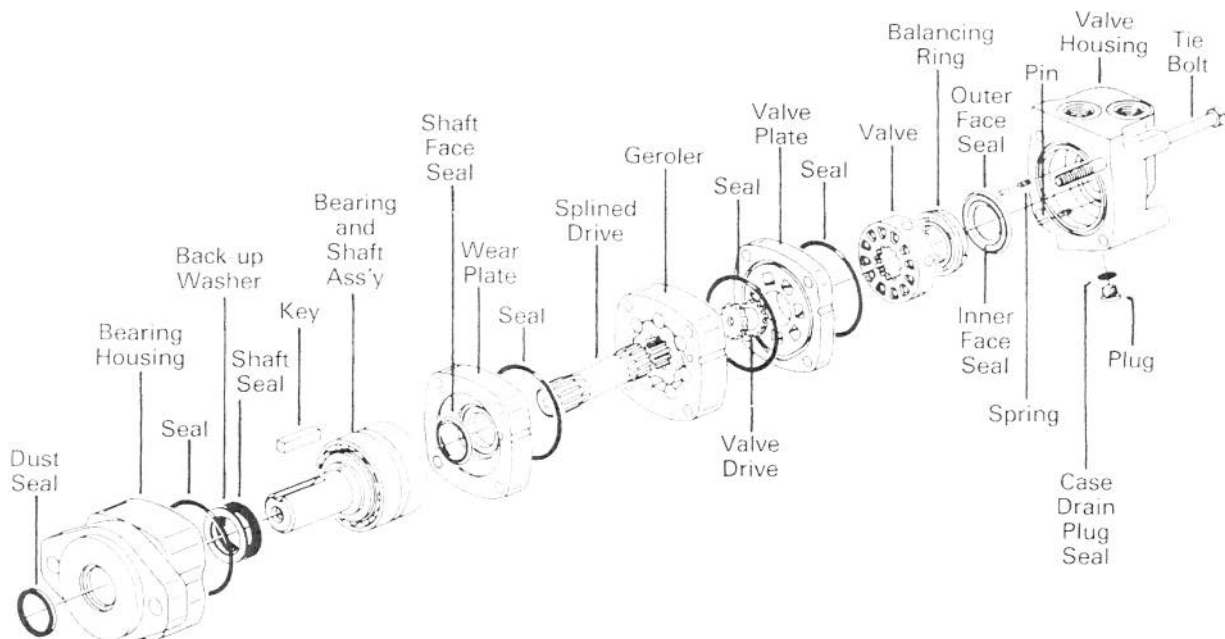

Figure 89

MAINTENANCE

Disassembly:

1. Insure ports are capped. Wire brush exterior parts of motor to remove contamination, and drain oil from motor.
2. Stand the motor upright (shaft side down) and clamp the bearing housing in a soft-jawed vise.
3. Remove 4 bolts from motor (Fig. 90).

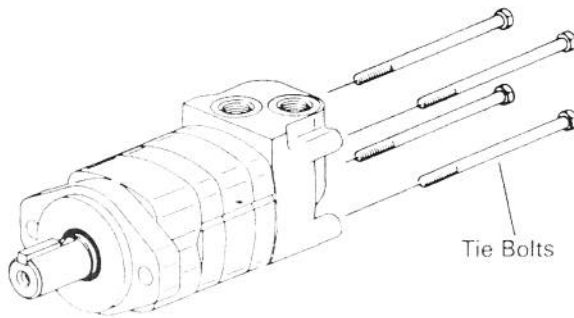

Figure 90

4. Lift valve housing straight up. If done carefully the pins, springs, balance ring assembly, and valve will remain on the valve plate (Fig. 91).

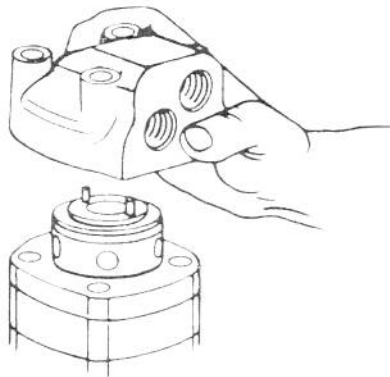

Figure 91

5. Carefully remove 3" diameter seal from valve housing (Fig. 92).

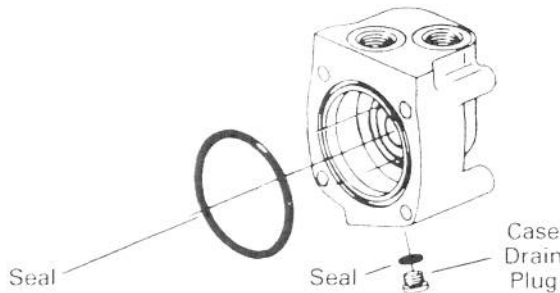

Figure 92

6. Remove case drain plug — with seal, from valve housing (Fig. 92).
7. Remove 2 pins and 2 springs from balance ring assembly (Fig. 93).
8. Remove balance ring assembly (Fig. 93).
9. Remove inner and outer face seals from balance ring (Fig. 93).
10. Remove the valve (Fig. 93).

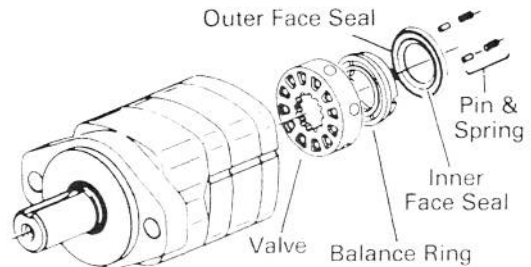

Figure 93

11. Remove the valve plate (Fig. 94).
12. Remove the 3" diameter seal from valve plate (Fig. 94).
13. Remove the valve drive (Fig. 94).

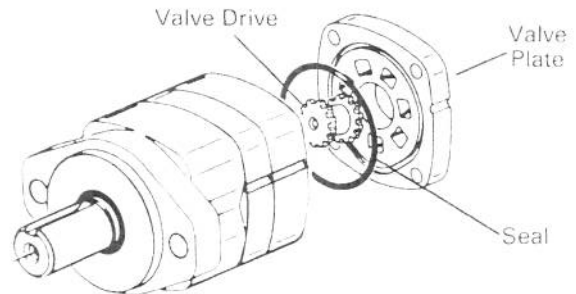

Figure 94

14. Remove the Geroler. Be sure to retain the rollers in the outer ring if they are loose (Fig. 95).
15. Remove the drive (Fig. 95).
16. Remove the 3" diameter seal from wear plate (Fig. 95).
17. Remove the wear plate (Fig. 96).
18. Remove the shaft face seal from the wear plate (Fig. 96).

MAINTENANCE

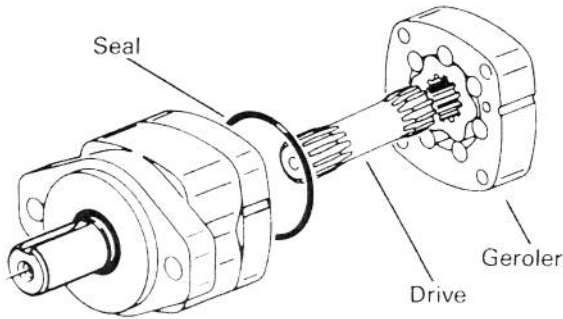

Figure 95

19. Remove the 3" diameter seal from bearing housing (Fig. 96).

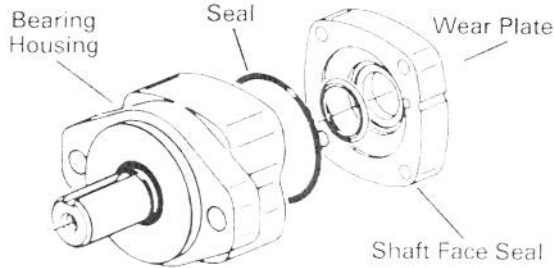

Figure 96

20. You may need a press to remove shaft and bearing assembly from bearing housing (Fig. 97).

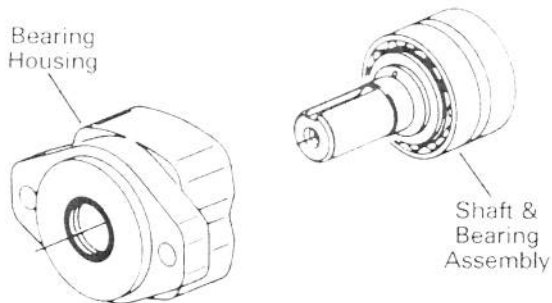

Figure 97

21. Use a small screwdriver to remove shaft seal, back-up washer and dust seal from bearing housing, see Fig. 98. Do not damage bore of housing.

22. Examine all mating surfaces for scratches, burrs, etc. Replace any parts damaged enough to cause leakage or which show excessive wear. Check shaft keyway for burrs or nicks which could cause seal damage.

23. Clean all metal parts in clean solvent and blow dry with air. Do not wipe dry with cloth or paper towel. Visually inspect all parts. Replace all damaged or worn parts and all seals and O-ring seals.

Note: Lubricate all seals (prior to installation) with petroleum jelly. Use new seals when reassembling this motor.

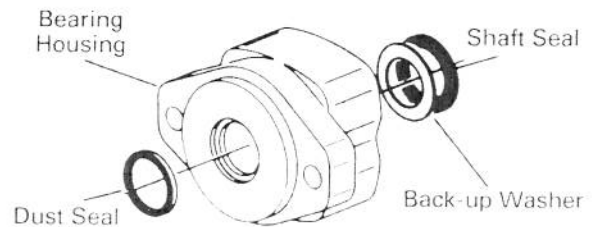

Figure 98

Reassembly:

1. Use a press to install dust seal in outer bore of bearing housing. Lip of seal must face outward. See Fig. 99. If a press is **not** available use a plastic or rubber hammer, being careful not to damage or cock seal in the bore.

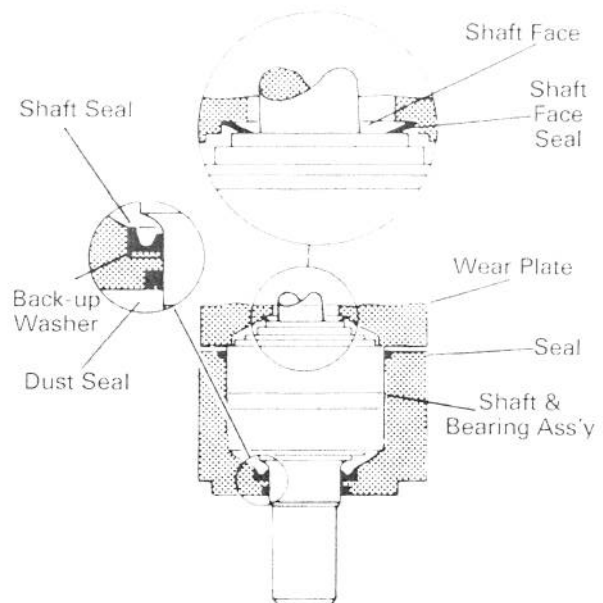

Figure 99

MAINTENANCE

2. Place back-up washer into seal bore. Place shaft seal onto installation tool and press seal into seal bore of the housing.

3. Clamp housing in vise.

4. Place protective bullet over shaft. Apply petroleum jelly to inside diameter of dust and shaft seal. You may need a press to install shaft and bearing assembly. Do not distort shaft seal. Damage to this seal will cause leakage.

Note: Bullet for 1" shafts. Use tape over other shafts to prevent cutting the seals.

5. Apply petroleum jelly to the 3" diameter seal. Install seal into the bearing housing.

6. Alignment studs can be very helpful in reassembly of the motor. If you use studs, install 2 studs diagonally opposed in the bearing housing.

7. Install the shaft face seal in the wear plate as shown in Fig. 99. Do not distort seal.

8. Install the wear plate (Fig. 99).

9. Apply a light film of petroleum jelly to the 3" diameter seal and install seal in the wear plate.

10. Install the drive in the bearing housing.

11. Align the notch on the outside of the Geroler with the notch on the wear plate. Install the Geroler against the wear plate. Be sure to retain the rollers in the outer ring if they are loose.

Note: Installation at this time involves 3 steps in the timing of the motor. Timing determines the direction of rotation of the output shaft. Timing parts include:

- | | |
|----------------|----------------|
| 1. Geroler | 3. Valve Plate |
| 2. Valve Drive | 4. Valve |

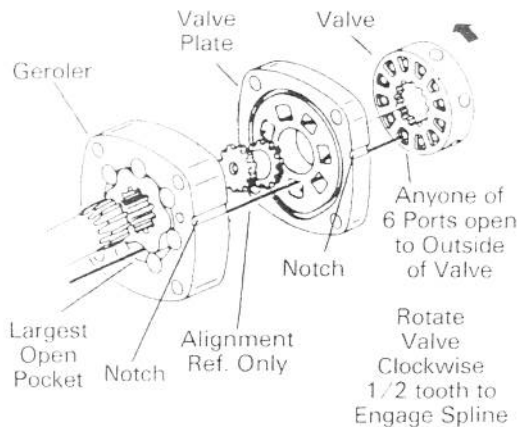

Figure 100

Timing Step #1 — Locate the largest open pocket in the Geroler and mark it on the outside edge of the Geroler (Fig. 100).

12. Install the valve drive in the Geroler.

13. Apply a light film of petroleum jelly to the 3" diameter seal. Install seal in groove of valve plate.

14. Align the notch on the outside of the valve plate with the notch on the Geroler as shown in Fig. 100.

Timing Step #2 — Locate the slot opening in the valve plate which is in line with the largest open pocket of the Geroler.

Timing Step #3 — Locate any one of the side openings of the valve and align this opening with the open slot of the valve plate that is in line with the largest open pocket of the Geroler. Install the valve by rotating it clockwise until the spline teeth engage (1/2 spline tooth). This will provide the proper rotation when pressurized as shown in Fig. 101.

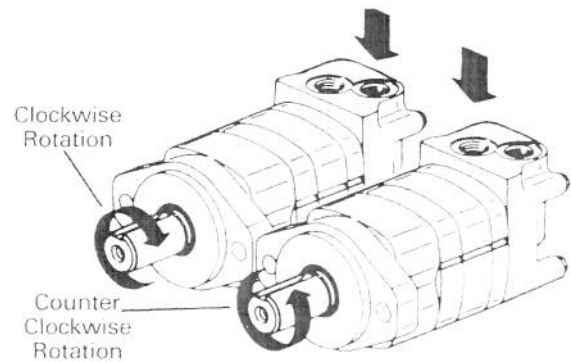

Figure 101

15. Install 2 springs and 2 pins in the holes located in the bore of the valve housing, as shown in Fig. 102.

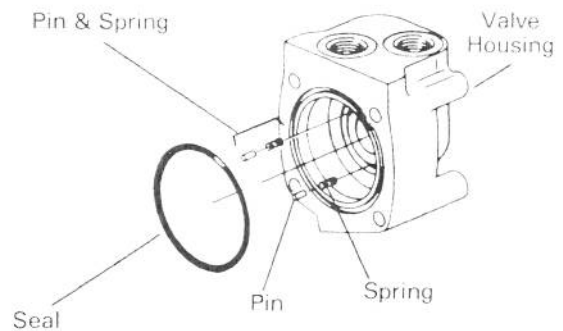

Figure 102

MAINTENANCE

16. Apply a light film of petroleum jelly to the 3" diameter seal. Install seal in the valve housing.

17. Apply petroleum jelly to inner and outer face seals. Install seals on balance ring as shown in Fig. 103.

IMPORTANT: Install face seals in the positions shown in Fig. 103, or the motor will not operate properly. Do not force or bend the face seals. Any damage to these seals will affect the operation of the motor.

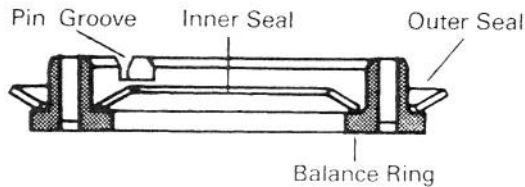

Figure 103

18. Align pin grooves in balance ring with pins in bore of the valve housing. Install balance ring assembly in valve housing.

19. Insert your finger through port of housing. Apply pressure to side of balance ring as shown in Fig. 104. Hold ring in position until valve housing is in place. Install valve against valve plate as shown in Fig. 105.

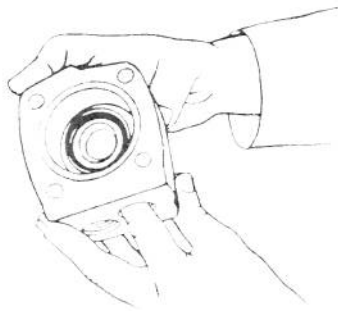

Figure 104

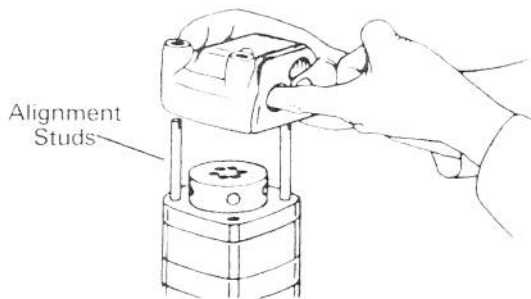

Figure 105

Note: After installing the valve housing on the valve plate check for proper placement. Push down on the valve housing. You should get a slight spring action.

20. Install the tie bolts (Fig. 106). If you use alignment studs, install 2 bolts opposite the studs. Finger tighten the bolts. Remove the alignment studs and replace with the 2 remaining bolts. Torque all 4 bolts alternately to 450 lb-in.

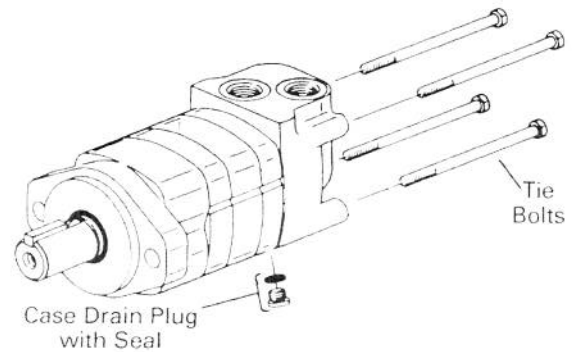

Figure 106

21. Install seal on case drain plug then install in valve housing. Torque to 50 lb-in.

REMOVING CUTTING UNIT DRIVE MOTOR

Tools Required: Drain Pan, 3/8, 1/2, 9/16, 11/16, 7/8, 1-1/4 inch Wrenches, Allen Wrench.

1. Remove inspection cover from chain case.
2. Loosen flange screw securing chain idler and slack off chain (Fig. 107).

Note: Tie chain up so it won't fall into case when motor is removed or install shipping cover, Part No. 42-4300; refer to Turf Pro 84 Cutting Unit Operator's Manual, Sharpening The Reel Assembly, page 8.

3. Remove and cap lines and fittings.
4. Disassemble top shield fasteners from end opposite motor, remove nuts securing motor to case, push capscrews back, remove shield, lift chain off motor sprocket and remove motor from case.
5. Loosen set screws securing sprocket to motor shaft and remove sprocket.
6. Repair or replace motor; refer to Servicing Reel Drive Motor, page 72 and Installing Reel Drive Motors to No. 2 and 3 Cutting Units, page 12. Fill motor with fresh, clean oil before installing.

MAINTENANCE

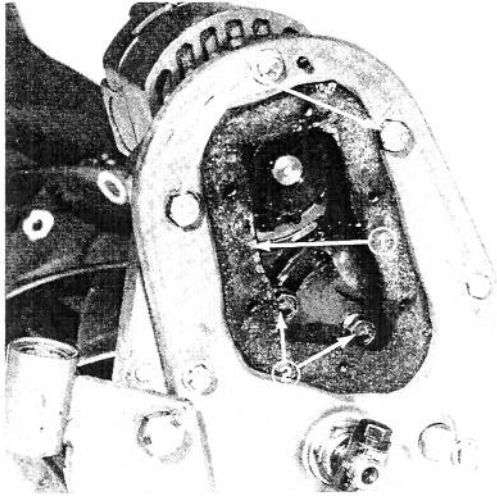

Figure 107

1. Drive chain
2. Idler mounting capscrews
3. Reel motor mounting capscrews

Note: Installation instructions for No. 2 & 3 cutting units also applies to No. 1 cutting unit.

SERVICING CUTTING UNIT DRIVE MOTOR

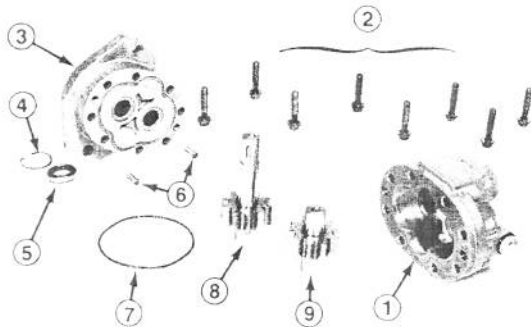

Figure 108

- | | | |
|---------------------|---------------|------------------------|
| 1. Housing assembly | 4. Snap ring | 7. O-ring seal |
| 2. Capscrews | 5. Shaft seal | 8. Drive gear assembly |
| 3. Front plate | 6. Dowel pins | 9. Idler gear assembly |

Tools Required: Seal Protector, Pliers, Snap Ring Pliers, 3/8 inch 12 point Socket Wrench, Soft-faced Hammer or Arbor Press, Screwdriver.

Disassembly:

1. Remove motor from machine: refer to Removing Cutting Unit Drive Motor, page 72. Clean outside of motor with solvent and dry thoroughly.
2. Remove woodruff key from shaft, scribe match marks at housing and front plate to ensure proper reassembly. Secure motor in a vise, shaft end down and remove capscrews from motor. Remove from vise and separate front plate assembly from hous-

ing assembly by bumping shaft against wooden block.

3. Remove all nicks and burrs from parts with emery cloth. Remove snap ring and shaft seal. Discard seal and snap ring and wash and dry all parts. Inspect drive gear shaft for broken or cracked keyway, both drive gear and idler gear shafts for rough surfaces and excessive wear at bearing points. If either shaft measures less than 0.685 in. (17.399 mm), replace the assembly. Ensure snap rings are in grooves.

Note: One gear assembly may be replaced separately. Shafts and gears are available only as assemblies.

4. Inspect gear face for scoring and excessive wear and measure gear width. Replace assembly if face is heavily scored or width of gear is less than 0.768 in. (19.5 mm).

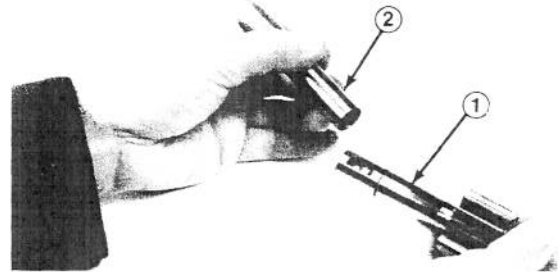

Figure 109

1. Drive gear
2. Seal protector

5. If gears are useable, but edges of gear teeth are sharp, break edges with emery cloth.

6. Measure I.D. of bushings in housing and front plate. If I.D. exceeds 0.693 in. (17.6 mm), replace assembly.

Assembly:

1. Dip gear assemblies into oil and install into front plate bushings.
2. Install housing assembly, insert capscrews and torque evenly to 22-25 ft-lb (30 - 34 N·m).
3. Oil new shaft seal liberally. Install seal over drive gear shaft, using either a seal protector (Fig. 109) or carefully working seal over shaft to prevent cutting seal lip. Seat seal by tapping it in with plastic hammer. Install a new snap ring.

Note: Seal protectors can be obtained from your local TORO distributor.

MAINTENANCE

4. Rotate motor shaft by hand or pliers. Motor will have small amount of drag, but should turn freely after short period.

REMOVING AND REPLACING HYDRAULIC LIFT CYLINDER

Tools Required: Drain Pan, Pliers, 11/16 inch Wrench.

1. Lower cutting units.
2. Remove and cap hydraulic lines and fittings.
3. Disassemble cotter pins from top and lower cylinder pins, remove pins and remove cylinder from machine.
4. Repair or replace cylinder; refer to Servicing Hydraulic Cylinder, page 73. Fill cylinder with fresh, clean oil before mounting. Reassemble in reverse order.

SERVICING THE HYDRAULIC CYLINDER

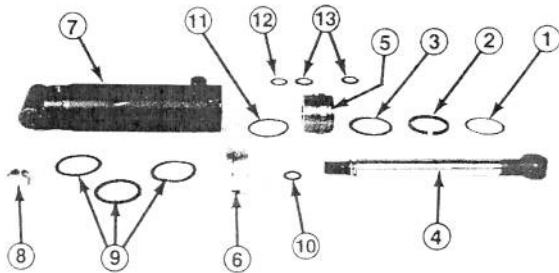

Figure 110

- | | |
|-------------------|----------------------|
| 1. Lock ring | 8. Nut |
| 2. Spacer | 9. Piston seals |
| 3. Head lock ring | 10. Rod O-ring seal |
| 4. Rod | 11. Head O-ring seal |
| 5. Head | 12. O-ring seal |
| 6. Piston | 13. Rod wipers |
| 7. Cylinder tube | |

Tools Required: 1-1/8 inch Wrench, Small Screwdriver, De-burring Knife.

1. Remove the cylinder from the machine; refer to Removing and Replacing The Hydraulic Cylinder, page 73.
2. Uncap the cylinder line ports and remove lock ring from top of cylinder tube.
3. Push head assembly down into tube approximately 3/4 inch (19 mm) and remove spacer.
4. Remove the head lock ring in the same manner as the outer lock ring.

5. Deburr the top edge of the head lock ring groove to prevent damage to head and piston during removal.

6. Pull rod, head and piston out of tube.
7. Clamp the end of rod in a vise and remove nut, piston and head assembly.
8. Inspect rod, tube and piston for wear. Replace if deep grooves are worn in rod or O.D. of piston. Lightly clean with crocus cloth, I.D. of tube if scratches or pits are evident. If they are too deep to clean up easily, replace tube.
9. Replace all seals and backup washers to insure against leakage. Soak backup washers thoroughly in oil. Oil all O-ring seals. Take care not to stretch seals and washers. Make certain they are not twisted when installed.

10. Replace the nut. Place a light film of oil on rod and inside head assembly, slide lock ring, spacer, head lock ring and head assembly onto rod.

11. Install rod, O-ring seal in groove on rod and install piston and nut.

12. Lock end of rod in vise and torque nut to 50 ft-lb (68 N·m).

13. Coat I.D. of tube and O.D. of O-ring seals with oil, clamp pin end of tube in a vise and insert piston, head and rod assembly.

14. Push head in past lock ring groove and install head lock ring.

15. Install spacer and outer lock ring.

16. Fill cylinder with fresh, clean oil and install on machine.

BY-PASS CONTROL VALVE REMOVAL, REPLACEMENT AND ADJUSTMENT

1. Lower cutting units, place drain pan under valve and disconnect linkage (Fig. 111).
2. Remove and cap all lines to valve (Fig. 111).

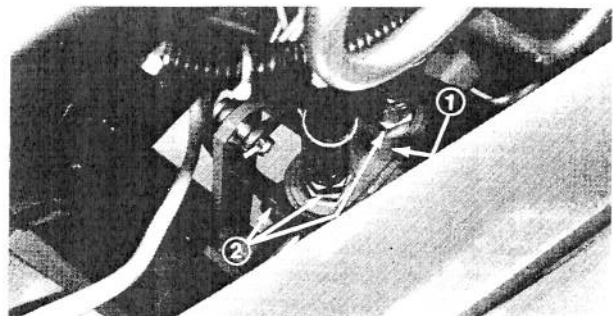

Figure 111

1. By-pass control valve
2. Hydraulic lines

MAINTENANCE

3. Remove locknuts and capscrews securing valve and remove valve.
4. Repair or replace, as necessary.
5. Reverse procedures to install valve.

Note: Assemble linkage with hydraulic cylinder completely retracted and valve spool positioned inward.

WIRING HARNESS SERVICE

To prevent corrosion of terminals apply Grafo 112X (Skin-Over) grease, Toro Part No. 505-47, to the inside of all harness connectors whenever harness is replaced. Always disconnect the battery to prevent possible wiring damage from short-outs whenever working with the electrical system.

INTERLOCK SWITCH TESTING MOW-BACKLAP SWITCH

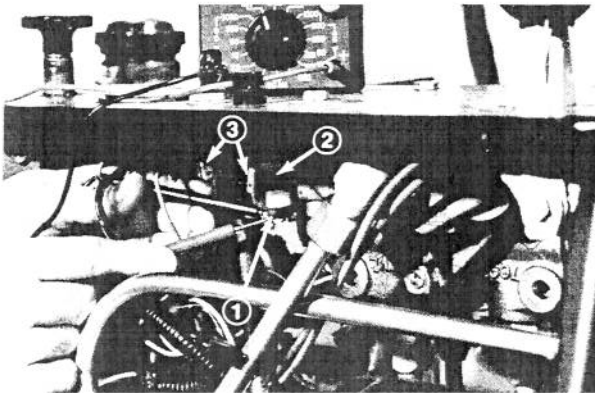

Figure 112

1. Meter probes to switch terminals
2. Valve bonnet
3. Wiring harness removed for clarity

Tools Required: Volt-ohm Meter or Continuity Tester, Quantity of Grafo 112X (Skin-over) grease, Toro Part No. 505-47, 7/16 inch Wrenches.

1. Unlatch and raise engine cowl and remove switch connector from switch.
2. Connect each end of meter leads to each switch terminal and check switch continuity with Mow-Backlap lever in MOW and BACKLAP positions and in OFF position (Fig. 112). Switch should indicate continuity with lever in OFF position. Switch should not indicate continuity when lever is in MOW or BACKLAP position.
3. Replace switch if tests indicate switch is defective. Coat connector terminals for switch with Grafo 112X (Skin-over) grease, Toro Part No. 505-47, before connecting the main wire harness. Refer to Replacing Mow-Backlap Interlock Switch, page 74.

4. Lower engine cowl and continue operation.

REPLACING MOW-BACKLAP INTERLOCK SWITCH

Tools Required: Quantity of Grafo 112X (Skin-Over) grease, Toro Part No. 505-47, Volt-Ohm Amp Meter or Continuity Meter.

1. Unscrew switch from valve bonnet, discard switch and install and tighten replacement switch.
2. Connect ohm meter leads to switch terminals and check for continuity (Fig. 112). Switch should indicate continuity when lever is in OFF position and should not indicate continuity when lever is in MOW or BACKLAP position.
3. Fill terminal connector with Grafo 112X (Skin-Over) grease, Toro Part No. 505-47 before connecting to switch.

TRACTION INTERLOCK SWITCHES

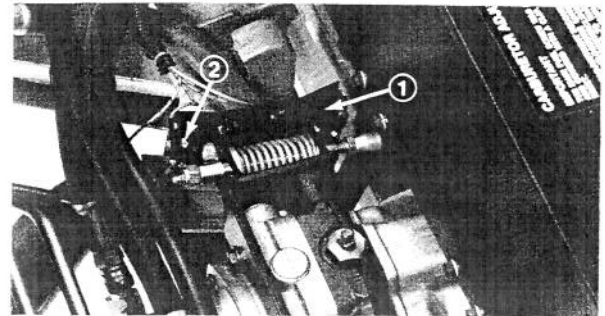

Figure 113

1. Front traction interlock switch
2. Rear traction interlock switch

Tools Required: Volt-Ohm Meter or Continuity Tester, Quantity of Grafo 112X (Skin-Over) grease, Toro Part No. 505-47, Small Screwdriver, 7/32 inch Wrench.

1. Unlatch and raise engine cowl and remove floor plate.
2. Remove wire harness connectors and connect each end of continuity meter leads to each switch terminal.
3. Test switches by moving traction pedal in forward and rearward direction. Front switch controls forward operation, rear switch reverse operation.
4. Both switches should indicate continuity when traction pedal is in NEUTRAL position.
5. Actuate pedal in FORWARD direction and connect meter leads to rear switch. Switch should not indicate continuity.

MAINTENANCE

6. Actuate pedal in REVERSE direction and connect meter leads to front switch. Switch should not indicate continuity.

7. If either switch does not function as described, replace switch. Tighten switch mounting screws carefully to avoid overtightening and damaging switch.

8. Fill terminal connectors with Grafo 112X (Skin-Over) grease, Toro Part No. 505-47 and connect together.

9. Replace floor plate, lower engine cowl and resume operation.

SEAT INTERLOCK SWITCH

Tools Required: Volt-Ohm Meter or Continuity Tester, Quantity of Grafo 112X (Skin-Over) grease, Toro Part No. 505-47, 11/16 and 7/8 inch Wrenches.

1. Separate seat switch wire connector from switch and test switch while sitting on seat and while off seat.

2. Connect a meter lead to each switch terminal and check switch with no load on the seat (Fig. 114). Switch should not indicate continuity.

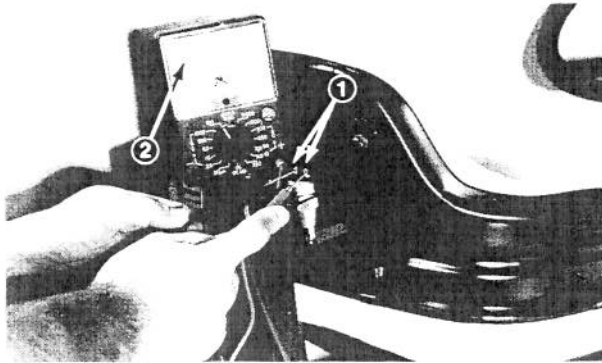

Figure 114

1. Seat switch terminals
2. No continuity on meter

3. Have someone sit on seat, adjust seat spring tension and connect meter leads to switch wire terminals (Fig. 115). Switch should indicate continuity.

4. Replace switch if tests indicate it is defective. Fill connector for switch with Grafo 112X (Skin-Over) grease, Toro Part No. 505-47.

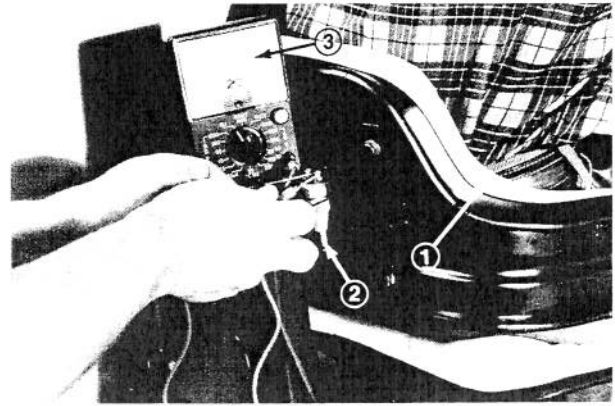

Figure 115

1. Load on seat
2. Switch actuated
3. Continuity indicated on meter

ELECTRICAL TROUBLE SHOOTING

Condition	Cause	Correction
1. Engine starts (but should not) when traction pedal is engaged.	<ul style="list-style-type: none"> • Traction switches incorrectly adjusted or defective. 	<ul style="list-style-type: none"> • Visually inspect switches. Test and adjust or replace switches; refer to Traction Switch Test, page 75.
2. Engine starts (but should not) when control lever is moved to MOW or BACKLAP position.	<ul style="list-style-type: none"> • Interlock switch is defective. 	<ul style="list-style-type: none"> • Visually inspect switch. Test and adjust, if necessary; refer to MOW-BACKLAP switch test, page 74 and MOW-BACKLAP Switch replacement, page 74.
3. Engine will not crank, regardless of traction pedal or MOW-BACKLAP control lever position.	<ul style="list-style-type: none"> • MOW-BACKLAP or traction pedal switches are maladjusted or are defective. • Defective fuse. • Loose wires on interlock switches. • Corroded battery terminals. • Dead battery. • Defective starter solenoid • Defective ignition switch. • Defective starter. • Loose ignition switch, ammeter or starter solenoid wires. • Engine seized. 	<ul style="list-style-type: none"> • Visually inspect switches. Adjust if necessary. Test switches; refer to Traction Switch and MOW-BACKLAP Switch tests, page 74, 75. • Replace. • Visually inspect and correct, if necessary. • Clean terminals. • Charge or replace. • Replace. • Replace. • Repair or replace. • Repair as necessary. • Repair.
4. Engine will not crank with traction pedal and MOW-BACKLAP lever neutralized and operator off seat, but cranks with operator on seat.	<ul style="list-style-type: none"> • Wiring harness improperly connected. • Defective wiring harness. 	<ul style="list-style-type: none"> • Refer to Electrical Schematic, page 76. Connect wires in proper location. • Replace harness.
5. Engine cranks but will not start with traction pedal and MOW-BACKLAP control lever in neutral.	<ul style="list-style-type: none"> • Problem unrelated to interlock switch wiring system. • Engine coil or rectifier wires loose. • Engine trouble or out of gas. 	<ul style="list-style-type: none"> • Proceed to next cause. • Inspect and correct. • Determine problem and correct.
6. Engine does not stop when operator is off seat and traction pedal is engaged.	<ul style="list-style-type: none"> • Traction switches maladjusted or are defective. • Seat switch maladjusted or defective (Suspension seat). 	<ul style="list-style-type: none"> • Adjust if necessary. Test switches; refer to Traction Switch Test, page 75. • Adjust if necessary. Test switch; refer to Seat Switch Test, page 75.

ELECTRICAL TROUBLE SHOOTING

Condition	Cause	Correction
7. Engine does not stop when operator is off seat and MOW-BACKLAP lever is engaged.	<ul style="list-style-type: none"> • MOW-BACKLAP interlock switch is defective. • Seat switch maladjusted or defective 	<ul style="list-style-type: none"> • Test and adjust, if necessary; refer to MOW-BACKLAP switch test, page 74 and Replacing MOW-BACKLAP switches, page 74. • Adjust if necessary. Test switch; refer to Seat Switch Test, page 75.
8. Engine stops when operator is on seat and traction pedal is actuated.	<ul style="list-style-type: none"> • Seat switch is maladjusted or is defective 	<ul style="list-style-type: none"> • Adjust switch if necessary. Test switch; refer to Seat Switch Test, page 75.
9. Engine stops when operator is on seat and MOW-BACKLAP lever is actuated.	<ul style="list-style-type: none"> • Seat switch maladjusted or is defective 	<ul style="list-style-type: none"> • Adjust switch if necessary. Test switch; refer to Seat Switch Test, page 75.
10. Engine stops when operator leaves seat regardless of traction pedal position or MOW-BACKLAP lever position.	<ul style="list-style-type: none"> • Traction or MOW-BACKLAP interlock switch is defective. • Loose interlock switch wires. 	<ul style="list-style-type: none"> • Test and adjust, if necessary; refer to Traction Switch Test, page 75 and MOW-BACKLAP Switch Test, page 74 Also Replacing MOW-BACKLAP Switches, page 74. • Correct condition.
11. Engine seems to cut out too much during transport. NOTE: Some cut out is normal.	<ul style="list-style-type: none"> • Seat switch not properly engaged. 	<ul style="list-style-type: none"> • Repair or replace. • Instruct operator to sit back on seat during transport operation. • Adjust seat to match weight of operator
12. Engine will not stop when ignition key is rotated to OFF position.	<ul style="list-style-type: none"> • Wires shorted in engine connector. • Ignition switch defective. 	<ul style="list-style-type: none"> • Repair. • Replace switch.
13. Battery will not charge.	<ul style="list-style-type: none"> • Wire(s) loose in electrical system. • Regulator or engine charging circuit defective. 	<ul style="list-style-type: none"> • Inspect all connections. Perform necessary repairs. • Repair or replace parts as necessary.

MECHANICAL TROUBLE SHOOTING

Condition	Cause	Correction
ENGINE: 1. Loss of power.	<ul style="list-style-type: none"> • Out of fuel. • Clogged fuel line – debris in fuel tank. • Clogged fuel filter. • Low crankcase oil level. • Wrong oil in crankcase. • Throttle cable set incorrectly. • Choke closed. • Plugged air cleaner element. • Carburetor malfunction. • Ignition malfunction. • Clogged crankcase breather. • Cooling fins plugged with debris. Engine overheating. • Internal engine malfunction. • Hydraulic system malfunction. 	<ul style="list-style-type: none"> • Re-fill fuel tank. • Clean fuel tank. Use clean gasoline. • Replace filter (in fuel pump). • Add oil to proper level. Check level more frequently. • Replace with correct oil. Refer to engine manual. • Repair as necessary. • Readjust. • Replace element. Service more frequently. • Repair as necessary. • Repair as necessary. • Clean breather. • Clean fins. Repair engine as necessary. • Repair as necessary. • Refer to Hydraulic Trouble Shooting, pages 36-50.
2. Engine won't start.	<ul style="list-style-type: none"> • Faulty ignition system. • No fuel. • Defective starter system. 	<ul style="list-style-type: none"> • Repair as necessary. • Check fuel level. Add gasoline to tank. • Check connections, solenoid, starter motor, ignition switch.

The Toro Promise

A ONE YEAR LIMITED WARRANTY

The Toro Company promises to repair your TORO Product if defective in materials or workmanship. The following time periods from the date of purchase apply:

Commercial Products 1 Year

The costs of parts and labor are included, but the customer pays the transportation costs on walk rotary mowers with cutting unit widths of less than 25".

If you feel your TORO product is defective and wish to rely on The Toro Promise, the following procedure is recommended:

1. Contact your Authorized TORO Distributor or Commercial Dealer (the Yellow Pages of your telephone directory is a good reference source).
2. The TORO Distributor or Commercial Dealer will advise you on the arrangements that can be made to inspect and repair your product.
3. The TORO Distributor or Commercial Dealer will inspect the product and advise you whether the product is defective and, if so, make all repairs necessary to correct the defect without an extra charge to you.

If for any reason you are dissatisfied with the distributor's analysis of the defect or the service performed, you may contact us:

Write

TORO Commercial Products Service Department
8111 Lyndale Avenue South
Minneapolis, Minnesota 55420

The above remedy of product defects through repair by an Authorized TORO Distributor or Commercial Dealer is the purchaser's sole remedy for any defect.

THERE IS NO OTHER EXPRESS WARRANTY. ALL IMPLIED WARRANTIES OF MERCHANTABILITY AND FITNESS FOR USE ARE LIMITED TO THE DURATION OF THE EXPRESS WARRANTY.

Some states do not allow limitations on how long an implied warranty lasts, so the above limitation may not apply to you.

This Warranty applies only to parts or components which are defective and does not cover repairs necessary due to normal wear, misuse, accidents, or lack of proper maintenance. Regular, routine maintenance of the unit to keep it in proper condition is the responsibility of the owner.

All warranty repairs reimbursable under the Toro Promise must be performed by an Authorized TORO Commercial Dealer or Distributor using Toro approved replacement parts.

Repairs or attempted repairs by anyone other than an Authorized TORO Distributor or Commercial Dealer are not reimbursable under the Toro Promise. In addition, these unauthorized repair attempts may result in additional malfunctions, the correction of which is not covered by warranty.

THE TORO COMPANY IS NOT LIABLE FOR INDIRECT, INCIDENTAL OR CONSEQUENTIAL DAMAGES IN CONNECTION WITH THE USE OF THE PRODUCT INCLUDING ANY COST OR EXPENSE OF PROVIDING SUBSTITUTE EQUIPMENT OR SERVICE DURING PERIODS OF MALFUNCTION OR NON USE.

Some states do not allow the exclusion or limitation of incidental or consequential damages, so the above limitation or exclusion may not apply to you.

This warranty gives you specific legal rights, and you may also have other rights which vary from state to state.

COUNTRIES OTHER THAN THE UNITED STATES OR CANADA

Customers who have purchased TORO products exported from the United States or Canada should contact their TORO Distributor (Dealer) to obtain guarantee policies for your country, province or state. If for any reason

you are dissatisfied with your Distributor's service or have difficulty obtaining guarantee information, contact the TORO importer. If all other remedies fail, you may contact us at The Toro Company.

Compliance with Radio Interference Regulations Certified.
Certifié Conforme au Règlement sur le Brouillage Radioélectrique.

Printed in U.S.A.