



GASOLINE ENGINE
PM 7 NO. 33787 — 00001 & UP
DIESEL ENGINE
PM 7 NO. 33677 — 00001 & UP

**OPERATOR'S
MANUAL**

PARKMASTER® 7 (Gasoline Engine)
PARKMASTER® 7 (Diesel Engine)

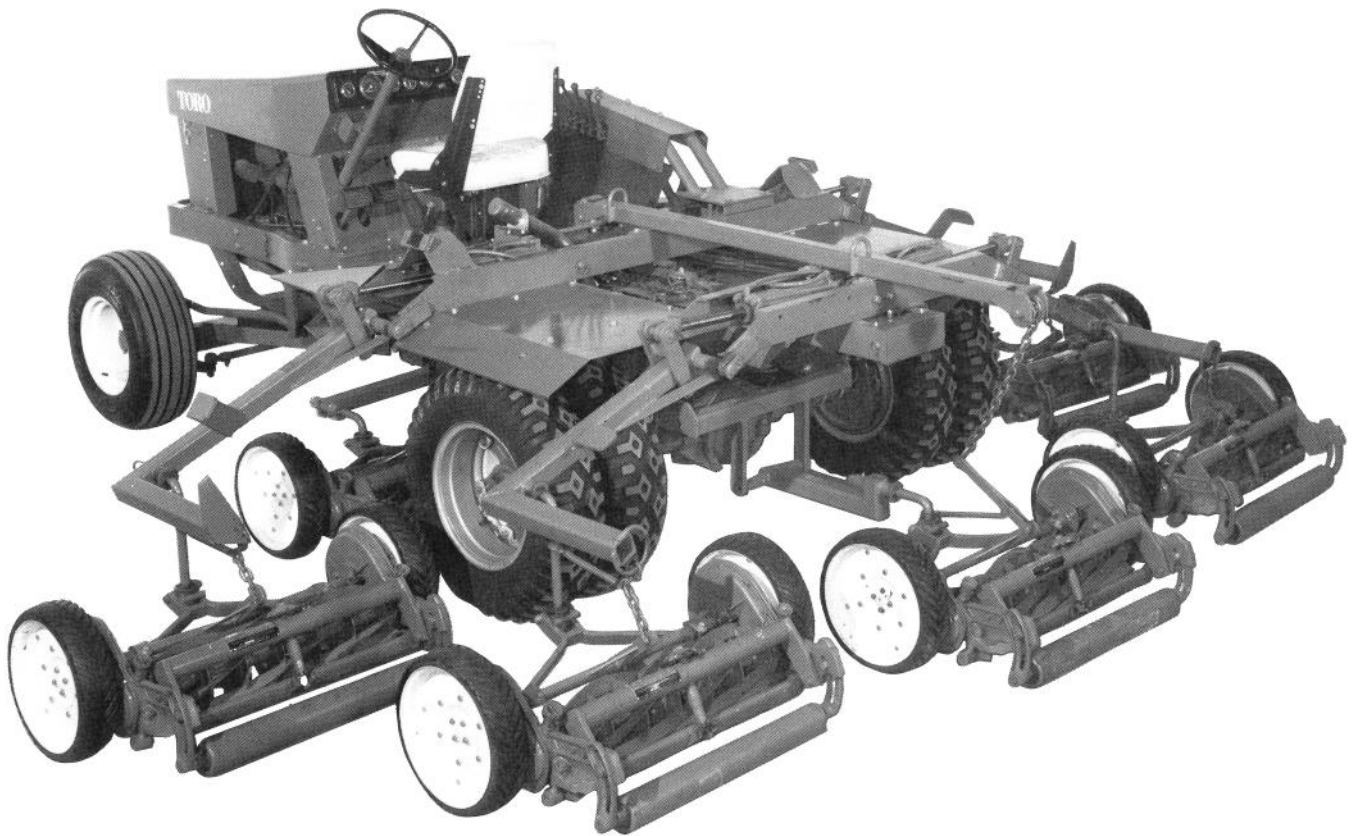

TABLE OF CONTENTS

	Page		Page
FOREWORD	3	Spark Plugs (Gasoline)	34
SAFETY INSTRUCTIONS	4-5	Carburetor (Gasoline)	34
SAFETY AND INSTRUCTION DECAL	5	Choke Wire Adjustment (Gasoline)	35
SPECIFICATIONS	6-10	Governor, Optional (Gasoline)	35
Engine Tune-Up Specifications	9	Engine Timing (Gasoline)	36
Parkmaster Frame Specifications	10	Fuel Filters (Gasoline)	36
GENERAL ASSEMBLY INSTRUCTIONS	11	Fuel Tank	36
Cutting Units	11	Fuel Filter (Diesel)	36-37
Mower Tire Inflation Pressure	11	Fuel Water Trap (Diesel)	37
Mower Drawbar Attachment Positions	11	Fuel Lift Pump (Diesel)	37-38
LOOSE PARTS CHART	11	Fuel Return Line (Diesel)	38
ATTACHMENT OF MOWERS TO LIFT ARMS	12-13	Fuel Injection Pump (Diesel)	38
Parkmaster 7 Mowers	12-13	Fuel Injectors (Diesel)	38
BEFORE OPERATION	14-18	Draining Fuel Tank	38
Check Engine Crankcase Oil (Gasoline)	14	Positive Crankcase Ventilation (PCV) Valve (Gasoline)	38-39
Check Engine Crankcase Oil (Diesel)	14	Flame Arrester (Gasoline)	39
Check Cooling System	14-15	Battery	39-40
Check the Battery (Gasoline), Batteries (Diesel)	15	Jump Starting with Auxiliary (Booster) Battery	40
Fill Fuel Tank	15	Manifold Heat Control Valve (Gasoline)	40
Check Power Steering Pump (Gasoline)	15	Engine Mounts	41
Check the Alternator Belt (Gasoline)	16	Fan Belts (Gasoline)	41
Check Fan and Alternator Belt (Diesel)	16	Power Steering Belt (Gasoline)	41
Check the Hydraulic System	16	Alternator Belt (Gasoline)	41
Check Hydraulic Brake Fluid	17	Fan and Alternator Belt (Diesel)	41
Check Transmission Fluid Level	17	Governor Belt (With Optional Governor) (Gasoline)	42
Check Rear Axle Fluid	17	Hydraulic Pump Belts, Matched Set (Gasoline)	42
Check Tire Pressures	18	Throttle Linkage (Diesel)	42
Check Torque of Front and Rear Wheel Nuts and Bolts	18	High Speed Stop (Diesel)	42
Grease Tractor and Hydraulic Frame	18	Idle Speed Stop (Diesel)	42-43
Visual Check of Machine	18	Clutch Adjustment	43
CONTROLS	18-21	Drive Shaft Universal Joints	43
OPERATING INSTRUCTIONS	22-26	Brake Adjustment and Service	44
Daily Pre-Operation Check	22	Master Cylinder	44
Fuel Requirements	22	Brake Linkage Adjustment	44
Starting/Stopping Engine (Gasoline)	23	Bleeding Brake System	45
Starting/Stopping Engine (Diesel)	23	Brake Shoes and Cylinders	45
Stopping the Engine	23	Service Brake	45
Checking Brake Operation	23	Disassembly	45-46
Training Operation	24	Cleaning and Inspection	46
Mowing Operation	24-25	Re-Assembly	46
Liquid Ballast	25	Adjustment	46
Transport Operation	26	Preliminary Adjustment Using Gauge	46
Towing the Parkmaster	26	Preliminary Adjustment Through Access Slot	47
TRACTOR LUBRICATION MAINTENANCE	26-29	Final Adjustment	47
Chassis	26	Front and Rear Axle Assembly	47
Engine Oil (Gasoline)	26-27	Front Wheel Toe-In	47
Engine Oil (Diesel)	27	Wheel Stops	48
Engine Oil Filter (Gasoline)	27	Tie Rod Ends	48
Engine Oil Filter (Diesel)	27	Drag Link Ends	48-49
Power Steering (Gasoline)	27-28	Front Axle Spindles	49
Power Steering (Diesel)	28	Wheel Bearings	49-50
Greasing Front Axle, Steering Linkage, Wishbone Pivot, Drive Shaft Universal Joints and Clutch and Brake Pedal Bushings	28	Rear Axle U-Bolt Locknuts	50
Lubricating Clutch, Hand Brake, Carburetor and Optional Governor Linkage	28-29	Lift Arm Frame Mounting Nuts	50
Transmission	29	Hood Latch	50
Rear Axle	29	Drawbar (Optional for Parkmaster)	50
Greasing Front Wheel Bearings	29	Lift Arm Bushing Replacement	51
HYDRAULIC SYSTEM AND FRAME LUBRICATION	30-31	Hydraulic Pump (Diesel)	51-52
Hydraulic Oil Level	30	Hydraulic Directional Control Valve	52
Breather Cap and Filter	30	Replacing Spool Seals	52-53
Hydraulic Oil Change	30	Hydraulic System Schematic	53
Greasing and Oiling Frame Components	30-31	Wiring Schematic (Gasoline Tractor)	54
TRACTOR AND FRAME MAINTENANCE	32-55	Wiring Schematic (Diesel Tractor)	55
Engine - Minor Maintenance (Gasoline)	32	TIRE MAINTENANCE AND REPAIR	56-58
Engine - Minor Maintenance (Diesel)	32	RECOMMENDED PROCEDURE FOR STORAGE (Gasoline)	59
Workshop Manual	32	TROUBLE SHOOTING CHART (Chevrolet Engine)	60-62
Important Notice	32	TROUBLE SHOOTING CHART (Perkins Diesel Engine)	63-64
Air Cleaner (Gasoline)	33	TROUBLE SHOOTING CHART (Steering Gear and Pump)	65
Air Cleaner (Diesel)	33	Maintenance Record	66-67
Cooling System	33-34	Product Changes	Back Cover
		Identification and Ordering	Back Cover
		The Toro Promise	Back Cover

FOREWORD

The PARKMASTER 7 Tractor was developed to meet the ever increasing demand for fine turf-grass mowing and proper turf care.

Because the PARKMASTER Tractor is a high quality turf-care machine produced with the most advanced concepts of engineering and design, Toro is concerned about the future use of the machines and safety of the users. Therefore, those persons involved with all aspects of use and maintenance of these machines should read this manual to familiarize themselves with safety, proper set-up, operation and maintenance instructions. The major sections of the manual are:

1. Safety Instructions
2. General Assembly Instructions
3. Before Operation
4. Controls
5. Operating Instructions
6. Maintenance - Chassis and Hydraulic Frame

The Chevrolet and Perkins Diesel engine, the transmission and axle are not covered in great detail in this manual. A handbook is included with the diesel engine tractors for the Perkins engine. Some service information, unique to the PARKMASTER Tractor is contained in this manual. All other information for these components is available from the respective manufacturer. Obtain engine and transmission information from:

- | | |
|--|---|
| <p>A. Chevrolet Engine
Helm, Inc.
P.O. Box 7706
Detroit, Mich. 48207</p> | <p>B. Perkins Diesel Engine
Workshop Manual
P.O. Box 697, 32500 Van Born Road
Wayne, Michigan 48184</p> |
|--|---|

Obtain rear axle information from:

Dana Corporation
P.O. Box 191
Auburn, Ind. 46706

Safety, mechanical and some general information in this manual is emphasized. DANGER, WARNING and CAUTION identify safety messages. Whenever the triangular safety symbol appears, it is followed by a safety message that must be read and understood. More complete details on safety are covered on pages 4 and 5. IMPORTANT identifies special mechanical information and NOTE identifies general information worthy of special attention.

OPTIONAL SPARK ARRESTER

In some areas there are local, state or federal regulations requiring that a spark arrester be used on the engine of this mower. If a spark arrester is required, order the following parts from your local dealer:

- 1 37-4250 Spark Arrester Assembly (Diesel)
- 1 37-4260 Spark Arrester Assembly (Gasoline)

These parts are approved by the United States Department of Agriculture and the United States Forest Service.

When mower is used or operated on any California forest, brush or grass covered land, a working order spark arrester must be attached to muffler. If not, the operator is violating state law, Section 4442 Public Resources Code.

Contact the local Authorized TORO Distributor if help concerning set-up, operation, maintenance or safety is ever needed. The local Authorized TORO Distributor is stocked with genuine TORO replacement parts and optional equipment for the complete line of TORO turf care equipment. Keep your TORO all TORO. Buy genuine Toro parts and accessories.

SAFETY INSTRUCTIONS



This safety alert symbol means **CAUTION, WARNING or DANGER** — “personal safety instruction”. Read and understand the instruction because it has to do

with safety. Failure to comply with the instruction may result in personal injury.

The TORO PARKMASTER 7 Tractor is designed, engineered and tested to offer reasonably safe and effective service. However, improper use or maintenance of the machine can result in injury. Compliance with the following safety instructions will reduce the potential for injury.

BEFORE OPERATING

1. Read and understand the contents of this manual before starting and operating the machine. Become familiar with the controls and know how to stop quickly. A free replacement manual is available by sending complete Model and Serial Number to:

The Toro Company
8111 Lyndale Ave. So.
Minneapolis, MN 55420

The Model and Serial Number Plate is located on the right hand side of the front instrument and control panel.

2. Keep all shields and safety devices in place. If a shield, safety device or decal is defective or damaged, repair or replace it before operation is commenced. Tighten any loose nuts, bolts and screws to make sure machine is in safe operating condition.

3. Do not operate machine while wearing sandals, tennis shoes, sneakers or shorts. Also, do not wear loose fitting clothing because it could get caught in moving parts. Always wear long pants and substantial shoes. Wearing safety glasses, safety shoes and a helmet is advisable and required by some local ordinances and insurance regulations.

4. On machines equipped with the Chevrolet engine, fill fuel tank with gasoline in open areas only. Gasoline is highly flammable. Handle it carefully and avoid spillage.

- A. Use only approved gasoline containers and dispensers. Fill slowly to allow air to escape from the tank.
- B. Do not smoke while handling gasoline.
- C. Wipe up any spilled gasoline.

- D. Be sure the fuel tank cap is in place and tightly secured.

WHILE OPERATING

5. Do not run the engine in a confined area without adequate ventilation. Exhaust fumes are hazardous and are deadly.

6. Seating capacity is one person. Therefore, never carry passengers on either the tractor or any towed or mounted implements.

7. Sit on the seat when starting the engine and operating the machine. Depress the clutch to start the engine.

8. When starting and stopping the engine:

- A. Set the parking brake.
- B. Shift the transmission to neutral position.

9. When making adjustment or repairs:

- A. Stop the engine.
- B. Set the parking brake.
- C. Block the wheels.

10. When leaving the machine unattended:

- A. Put the cutting units either fully up in transport or fully down in the mowing position.
- B. Set the parking brake.
- C. Shift the transmission to neutral position.
- D. Stop the engine and take the key from the switch.

11. Use of this machine demands complete operator attention. To prevent loss of control and machine damage:

- A. Check the tractor brakes daily.
- B. Mow and transport only in daylight or when there is good artificial light.
- C. Watch for holes or other hidden hazards.
- D. Be careful when near sand traps, ditches, water holes, creeks or other hazards.
- E. Reduce speed when making sharp turns and when turning on a hillside.
- F. Avoid sudden stops and starts.
- G. Attach the safety chains to the mowers before transporting the machine for long distances or on public roads.

SAFETY INSTRUCTIONS

- G. Do not exceed 20 MPH (32 Km/hr) during transport operation. Operate more slowly while traveling over rough terrain or in adverse weather conditions.
- H. Do not exceed 6 MPH (9.7 Km/hr) during mowing operation.

MAINTENANCE

12. On machines equipped with the Chevrolet engine, remove the key from ignition switch to prevent accidental starting of the engine when servicing or adjusting the engine or related components.

Remove the starter key on machines equipped with the Perkins diesel engine.

13. If the engine must be running to perform maintenance or adjustments:

- A. Set the parking brake.
- B. Shift the transmission to neutral position.
- C. Keep hands, feet, clothing and other parts of the body away from belts, pulleys, exhaust manifold and cooling fan.

- D. Stay clear of the ignition system of the gasoline engine tractor.
- E. Block the wheels.

14. Engine must be shut off before checking or adding oil to the engine crankcase, power steering reservoir or the hydraulic system reservoir.

15. Do not remove the radiator cap when the engine cooling system is at operating temperature. Check the coolant level of a cold engine before starting.

16. To reduce potential fire hazard, keep the entire machine free of excessive oil, grease, grass clippings and other debris.

17. If major repairs are ever needed or assistance is desired contact an Authorized TORO Distributor.

18. Inspect all brake system components frequently. Remove brake drums and inspect entire brake system every six months. Repair, adjust and clean as necessary.

SAFETY AND INSTRUCTION DECALS

 **CAUTION**
MAXIMUM RECOMMENDED
SPEED IS 20 M.P.H.

 **WARNING**
CHECK BRAKE SYSTEM AND STOPPING DISTANCE DAILY.
SEE OPERATOR'S MANUAL FOR COMPLETE DETAILS.

ON RIGHT HAND DASH PANEL
(Part No. 39-3680)

RECOMMENDED
GROUND SPEED
DECAL —
LOCATED ON
DASH PANEL
ABOVE
SPEEDOMETER.
(Part No. 28-1030)

DIESEL ONLY

NO. 2 DIESEL
FUEL ONLY

NEAR FUEL TANK
FILLER HOLE
(Part No. 19-3700)

UNDER FRONT
DASH PANEL
(Part No. 38-1690)

STARTING INSTRUCTIONS

CAUTION
 READ AND UNDERSTAND OPERATORS MANUAL BEFORE OPERATING THIS MACHINE. FREE REPLACEMENT MANUAL IS AVAILABLE BY SENDING COMPLETE MODEL AND SERIAL NUMBER TO:
 THE TORO COMPANY
 8111 LYNDALE AVENUE SOUTH
 MINNEAPOLIS, MINNESOTA 55420

- 1.) SHIFT TRANSMISSION TO NEUTRAL
- 2.) DEPRESS CLUTCH PEDAL (ENGINE WILL NOT CRANK IF PEDAL IS NOT DEPRESSED.)

DIESEL
 3.) PUSH IN FUEL CONTROL KNOB.

GASOLINE
 3.) PULL OUT CHOKE CONTROL KNOB FULLY FOR COLD START, PARTIALLY OUT FOR WARM START.

BOTH
 4.) DEPRESS FOOT THROTTLE SLIGHTLY

- 5.) TURN KEY TO "START" POSITION. RELEASE WHEN ENGINE STARTS (KEY WILL RETURN TO "RUN" POSITION)

TO STOP ENGINE

DIESEL — PULL FUEL CONTROL KNOB FULLY OUT

GASOLINE — TURN KEY TO "OFF" POSITION

INSTRUCTIONS POUR LE DEMARRAGE

ATTENTION
 LIREZ ET COMPRENEZ LE MANUEL DE L'OPERATEUR AVANT DE METTRE CETTE MACHINE EN MARCHE. VOUS POUVEZ OBTENIR GRATUITEMENT UN MANUEL DE REMPLACEMENT EN ENVOYANT LE NUMERO COMPLET DU MODELE ET CELUI DE L'ENREGISTREMENT, A:
 THE TORO COMPANY
 8111 LYNDALE AVENUE SOUTH
 MINNEAPOLIS, MINNESOTA 55420

- 1.) METTEZ LA TRANSMISSION AU POINT MORT
- 2.) APPUYEZ SUR LA PEDALE DE DEBRAYAGE (LE MOTEUR N'ENGRENERA PAS SI LA PEDALE N'EST PAS ENFONCEE)

DIESEL —
 3.) ENFONCEZ LE BOUTON DE COMMANDE DU COMBUSTIBLE

ESSENCE —
 3.) TIREZ LE BOUTON DE COMMANDE D'OBTURATEUR COMPLETEMENT POUR UN DEMARRAGE A FROID, PARTIELLEMENT POUR UN DEMARRAGE A CHAUD

POUR LES DEUX COMBUSTIBLES
 4.) APPUYEZ LEGEREMENT SUR LA PEDALE DU REGULATEUR

- 5.) TOURNEZ LA CLE EN POSITION "ALLUMAGE". RELACHEZ LA QUAND LE MOTEUR SE MET EN MARCHE (LA CLE RETOURNERA D'ELLE MEME SUR LA POSITION "MARCHE")

POUR ARRETER LE MOTEUR

DIESEL — TIREZ JUSQU' AU BOUT LE BOUTON DE COMMANDE DU COMBUSTIBLE

ESSENCE — TOURNEZ LA CLE EN POSITION "ARRET"

INSTRUCCIONES DE ARRANQUE

PRECAUCION
 LEA Y ENTIENDA EL MANUAL DE OPERACION ANTES DE OPERAR ESTA MAQUINA. UN MANUAL DE REPUESTO SERA DISPONIBLE GRATUITAMENTE, ENVIANDO EL NUMERO DEL MODELO Y SERIE COMPLETO A:
 THE TORO COMPANY
 8111 LYNDALE AVENUE SOUTH
 MINNEAPOLIS, MINNESOTA 55420

1.) PONGA LA TRANSMISION EN NEUTRAL

- 2.) OPRIMA EL PEDAL DE EMBRAGUE (EL MOTOR NO ARRANCARA SI EL PEDAL NO ESTA OPRIMIDO)

DIESEL
 3.) EMPUJE EL BOTON DEL CONTROL DE COMBUSTIBLE

GASOLINA
 3.) JALE EL BOTON DEL OBTURADOR DE GASOLINA COMPLETAMENTE PARA ARRANQUE EN FRIJO, Y PARCIALMENTE PARA ARRANQUE EN CALIENTE.

PARA AMBOS
 4.) OPRIMA EL PEDAL ACCELERADOR LIGERAMENTE

- 5.) GIRE LA LLAVE A LA POSICION DE ARRANQUE Y SUELTELA CUANDO EL MOTOR ARRANQUE (LA LLAVE VOLVERA A LA POSICION DE EN OPERACION)

PARA PARAR EL MOTOR

DIESEL — JALE EL BOTON DEL CONTROL DE COMBUSTIBLE HACIA AFUERA

GASOLINA — GIRE LA LLAVE A LA POSICION DE APAGADO

BEDIENUNGSANWEISUNGEN

VORSICHT
 LESEN UND VERSTEHEN SIE DIE GEBRAUCHSANWEISUNG EHE SIE DIESE MASCHINE IN GANG SETZEN. EINE ERSATZGEBRAUCHSANWEISUNG IST GRATIS ERHALTLICH, WENN SIE DIE VOLLESTANDIGE MODELL- UND SERIENUMMER AN DIE FOLGENDE ADRESSE SENDEN:

THE TORO COMPANY
 8111 LYNDALE AVENUE SOUTH
 MINNEAPOLIS, MINNESOTA 55420

1.) GANGSCHALTUNG AUF LEERLAUF STELLEN

- 2.) KUPPLUNGSPEDAL NIEDERDRÜCKEN (MOTOR WIRD NICHT ANSPRINGEN, WENN PEDAL NICHT NIEDERGEDRÜCKT IST.)

DIESEL
 3.) KRAFTSTOFFREGULIERUNGSKNOPF HINEINDRÜCKEN

BENZIN
 3.) CHOKEKNOPF BEI KALTSTART GANZ UND BEI WARMSTART HALB HERAUSZIEHEN

FÜR BEIDES
 4.) FUSSGASPEDAL LEICHT HERUNTERDRÜCKEN

- 5.) SCHLÜSSEL AUF "START" STELLUNG DREHEN UND LOSLASSEN, WENN MOTOR ANSPRINGT (SCHLÜSSEL WIRD AUF "FAHRT" STELLUNG ZURÜCKSPRINGEN)

MOTOR ABSTELLEN

DIESEL — KRAFTSTOFFREGULIERUNGSKNOPF VOLLSTÄNDIG HERAUSZIEHEN

BENZIN — SCHLÜSSEL AUF "AUS" STELLUNG DREHEN

SPECIFICATIONS

Engine (Gasoline): Chevrolet Motor Division, General Motors Corporation, Model 250 CID L-6. For further description see Engine Tune-Up Specifications, page 9.

Engine (Diesel): Perkins engine, Model 4-236, four cylinder, 4 cycle diesel with overhead valves with overhead valves with direct fuel injection. Rated 78 HP (58.2 Kw) @ 2500 RPM with 193 ft-lb (262.5 N·m) torque @ 1400 RPM. Compression ratio: 16:1.

Clutch: 11 inch (28 cm) diameter, diaphragm type, spring loaded, foot operated with torsional dampener for smooth engagement.

Throw-out Bearing: Ball type, pre-lubricated.

Flywheel Clutch Housing: Integral type, including rear engine mounting surfaces. Cast iron material.

Engine Mounts: Four point mounts, including resilient rubber mounts, dampening vibration between power train and frame.

Radiator: Tube and fin construction. Core 24.34 x 16.33 x 1.48 thick. Stamped brass top and bottom tanks. 15 P.S.I. pressure cap. 13 quart capacity on gasoline. 16 quart capacity on diesel. Coolant, permanent type ethylene glycol antifreeze.

Fan: 17 inch (0.432 m) diameter, 5 blade, staggered blade construction (gasoline). 6 blade, 1.93 pitch (diesel). Heavy duty construction, dynamically balanced with blades riveted to spider.

Starter Motor: 12-volt, 3 bolt attachment to flywheel-clutch housing. Integral solenoid with switch providing full voltage for cold weather starting.

Alternator: 62 ampere, 12 Volt alternator with integral solid state voltage regulator. Unit designed to withstand severe dusty & dirty operating conditions.

Ignition System (Gasoline): Coil and solid state high energy distributor with vacuum advance control to provide correct engine timing at various engine speeds.

Interlock Switch: Switch is provided so clutch must be depressed to start engine.

Carburetor (Gasoline): Single Barrel, industrial type, including stainless steel anti-friction ball bearings for use with governor. Fixed high speed jet standard. Adjustable jet available for high altitude conditions; contact your local Toro Distributor for assistance.

Air cleaner: Dry hat type with replaceable paper element 350 C.F.M. (0.165 m³/s) capacity.

Transmission: Chevrolet Division, General Motors Corp., Four speeds forward, one speed reverse, synchro-mesh shifting provided in 2nd, 3rd, & 4th gears. 275 ft-lb (373 N·m) torque capacity.

Gear Ratios:	1st	6.55:1
	2nd	3.58:1
	3rd	1.70:1
	4th	1.00:1
	Reverse	6:09:1

Lubrication, SAE 90 EP Grease, 8.5 pint (4 L) capacity.

Drive Shaft: 2-1/2 inch (64 mm) diameter tubing, two universal joints with relubricatable anti-friction bearings. Steel forged yokes.

Rear Axle: 6500 pound (2948 kg) load capacity 7.17:1 reduction with spiral bevel hypoid pinion and ring gear set. Full floating drive axle shafts. Malleable cast iron gear case, steel tubing trumpet housing. Removeable differential carrier and taper anti-friction bearings. Lubrication, SAE 90 EP grease, 11 pint (5.2 L) capacity.

Brakes: 12 inch (30.5 cm) diameter x 2-1/2 inches (64 mm) wide, self-adjusting, double servo hydraulic brakes on rear wheels, providing 131 sq-in. (845.2 cm²) total brake shoe area. Torque capacity approximately 55,000 in.-lb (6215 N·m).

Master cylinder: 3/4 inch (19 mm) diameter piston with spring return.

Parking brake provided with ratchet hand lever, multi-stranded cable & conduit, actuating brake shoes.

Throttle Controls: Foot pedal, with foot rest for operator comfort. Hand throttle included with optional governor kit (gasoline).

Hand Throttle (Diesel): Variable speed mechanical governor, integral with fuel injection pump, controlled by quadrant-type hand throttle lever mounted on steering cover.

Front Axle: Welded construction, four inch, 9-1/2 pound (4.3 Kg) structural steel I-beam with center pivot. Wishbone supports integral with axle. Steel spindle knuckles and steering arms. 50° maximum

SPECIFICATIONS

turn with adjustable stops to restrict turn if desirable. Needle bearings and roller thrust bearings on spindles. Sealed ball joints with grease fittings for lubrication.

Front Wheel Hubs: Cast iron hubs, tapered roller bearings.

Power Steering Gear: Recirculating ball screw, rack and pinion steering gear with integral 3-1/8 inch (79 mm) diameter power piston and directional flow control valve. Separate steering column with ball anti-friction bearings and flexible coupling between column and steering gear. Ratio 17.5:1 maximum output at 1000 P.S.I. (6895 kPa) 8,250 inch pounds (932 N·m) torque. 1-3/8 in. (35 mm) diameter tubular drag link with adjustable ball sockets and grease fittings for lubrication.

Power Steering Pump (Gasoline): Heavy duty, vane type design maintains high efficiency at high pressures and temperatures throughout its life. Flow control system allows external pump flow to drop off at higher speeds thereby decreasing back pressure in hydraulic system. Minimum output 1.25 G.P.M. (0.079 L/s) at 465 R.P.M., maximum output 3.1 G.P.M. (0.196 L/s) at 1500 R.P.M.

Relief valve adjusted to 1300 P.S.I. (8963 kPa); pump includes integral filter and reservoir and uses type "A" automatic transmission oil. Pump belt driven from engine crankshaft.

Steering Wheel: 15 inch (0.38 m) diameter, dished, hard rubber reinforced steel steering wheel. 3-3/4 turns of the steering wheel from maximum left turn to maximum right turn.

Frame: Welded construction. 5 inch (12.7 mm), 9 pound (4.1 Kg) structural steel channel reinforced to provide maximum strength.

Instrument Panel: Individual instruments, ammeter, fuel level, oil pressure, water temperature, hour meter and speedometer with odometer are all electrically powered. Hand choke for engine. Provisions for light switch, head & taillights, horn, direction signals, and slow moving vehicle lights when required. Key start ignition switch with interlock switch; clutch pedal must be depressed to start engine.

Hood & Cowling: Reinforced sheet steel with hood opening vertically from front to provide access to engine compartment.

Seat: Contour seat with wrap-around 16 inch (0.40 m) high back rest. Seat pan and back rest with foam filler and integral vinyl cover. Adjustable slide with 4 inch (10.2 cm) adjustment, forward and backward.

Seat Suspension: Suspension adjustable with hydraulic shock absorber to compensate for variable weight of operators.

Fuel Capacity: 15-1/2 gallons (59 L) tank mounted at rear of tractor with provisions for convenient refueling when mounted frames are used. Inline, replaceable fuel filter used to insure clean fuel supply to engine. Drain port provided for draining water and contamination from fuel tank.

Battery (Gasoline): 12 Volt, 54 plate, 45 ampere capacity. Battery includes anchor-bond construction where the plates are bonded to both top and bottom of case.

Batteries (Diesel): Two, 6 volt, heavy duty batteries, SAE Group size 1M4. Cranking power @ 0°F – 2500 watts average. 256 minutes reserve capacity. Provide 12 volt service.

Tool Box: Located beneath seat suspension assembly.

Tires & Wheels:

Rear: Dual 6.00 x 16 drop center, demountable, disc-type wheels with 4-ply, 7.50-16 tires with tubes.

Front: Drop center 14 x 8 wheels with 9.50-14, 4-ply, 1-l ribbed tubeless tires.

(See page 11 and 18 for recommended tire pressures of mowers and the tractor).

Dimensions:

Overall Length:

177 inches – 14 feet 9 inches (4.5 m) in mowing position.

Height: 66 inches (1.7 m) over steering wheel

Maximum width: 84 inches (2.1 m) (across rear tires)

Wheel base: 99 inches (2.5 m)

Front wheel tread: 61-1/4 inches (1.6 m)

Rear wheel tread: 65-1/2 inches (1.7 m)

Curb clearance: 10 inches (25.4 cm)

Speeds: Transport – 4th gear maximum transport speed varies depending upon weather conditions and road conditions. 20 MPH (32 Km/hr) should be considered maximum speed under ideal conditions.

SPECIFICATIONS

Working Speeds:

Gear	Engine Speed		
	1200 RPM	1600 RPM	2000 RPM
4th	14.69 MPH	19.59 MPH	—
3rd	8.64 MPH	11.52 MPH	14.41 MPH
2nd	4.10 MPH	5.47 MPH	6.84 MPH
1st	2.24 MPH	2.99 MPH	3.74 MPH
Rev.	2.41 MPH	3.22 MPH	4.02 MPH

In SI Units

	In SI Units		
	1200 RPM	1600 RPM	2000 RPM
4th	23.64 Km/hr	31.53 Km/hr	—
3rd	13.9 Km/hr	18.54 Km/hr	23.19 Km/hr
2nd	6.598 Km/hr	8.8 Km/hr	11.01 Km/hr
1st	3.6 Km/hr	4.81 Km/hr	6.02 Km/hr
Rev.	3.88 Km/hr	5.18 Km/hr	6.47 Km/hr

Turning Radius: Minimum of 7 feet 3 inches (2.2 m) from center of turn to closest side of rear dual tire on inside of turn. May be increased by adjusting stops at front axle.

Optional Equipment:

Governor (Gasoline Only): (Model #70145) Variable speed governor controlled by quadrant-type hand throttle lever mounted on steering column. Governor belt driven from engine water pump pulley. Speed range from 800 RPM to 2200 RPM.

Light Kit: (Model #70150) Consists of horn, directional lights with 4 way emergency flasher, head and taillights, slow moving vehicle lights, socket for slow moving vehicle sign and bracket and steering stabilizer.

Horn: 12 Volt utility horn with horn relay and water proof horn button attached to steering column.

Directional Signal Lights: Non-cancelling controller mounted on steering column, with pilot lights and 4-way emergency flasher switch. Four 12 Volt, SAE Class A, Type I signal lamps.

Head & Tail Lights: Two headlights, 12 Volt, 35 watt all glass sealed beam, single filament, 4-1/2 inch (11.4 cm) diameter lens, adjustable mounting. Two tail lights included with directional and stop light, double filament bulbs. Switch, fused and mounted in instrument panel.

Slow Moving Vehicle Lights: Four double-faced lamps, 12 volt, amber color, visible from front and rear of vehicle. Switch fused and mounted in instrument panel. Heavy duty flasher provided for continuous usage.

Slow Moving Vehicle Socket: Socket provided so that mounting bracket and slow moving vehicle sign can be installed on unit. Sign, if required, to be provided by the customer.

Steering Stabilizer: Provides improved steering stability. Consists of sealed hydraulic shock absorber plus mounting brackets. Attaches between tie rod and front axle reach.

Front Fenders: (Model #70196) Fabricated steel welded construction with rubber and fabric flaps. Fenders prevent material from being thrown from front tires, rearward.

Drawbar Kit: (#26-9260) Can be used with Parkmaster Units. Rear mower and frame lift arm must be removed on Parkmaster. Allows a large variety of implements to be pulled such as the TORO Universal Frame and Rake-O-Vac Sweeper. For cutting unit specifications see individual specification for these units.

Roll over Protection System — ROPS: ROPS consists of welded tubular front post frame, using 2-1/2 x 2-1/2 x 1/4 (64 x 64 x 6 mm) certified tubing, with fabricated steel mounting brackets for attaching to tractor. Seat belt provided for operator. Order from Palm Industries, P.O. Box 562, Litchfield, Minnesota 55355.

Cab: Cab consists of metal welded fabricated construction with tinted safety plate glass windows. Two piece windows in sliding track in rear and right side, single door, integral roll over protection system, 2 speed windshield wiper, 12 volt pressurized blower, and seat belt. Foam headliner attached to interior of roof. Maximum height of tractor with cab installed is 98 inches (2.44 m). Order from Palm Industries, P.O. Box 562, Litchfield, Minnesota 55355.

Spark Arresting Muffler: (Diesel; 37-4250) (Gasoline; 37-4260) Interchangeable with stock muffler. Aluminized steel construction. Fire causing sparks removed through centrifugal force created within spark arrestor. Particles are trapped safely for later removal. Muffler approved by United States Department of Agriculture and United States Forest Service.

Cold Start Kit: (Diesel; Model 44-0400) Ethyl ether can with solenoid operated control valve. Automatically assists with cold starting of diesel engine.

ENGINE TUNE-UP SPECIFICATIONS

(Model 33787, gasoline engine)

CHEVROLET ENGINE

Type	In-line, 6 Cyl.	Valve lash	0
Bore	3.88 in. (98.5 mm)	Cylinder head bolt torque	95 ft-lb (129.2 N·m)
Stroke	3.53 in. (89.66 mm)	Connecting rod bolt torque	65 ft-lb (88.4 N·m)
Engine Displacement (cu. in.)	250 (4100 cc)	Main bearing cap bolts	65 ft-lb (88.4 N·m)
Compression Ratio	8.5:1	Flywheel bolt torque	60 ft-lb (60 ft-lb (81 N·m)
Compression Pressure		Engine idle speed	400-450 RPM.
(at cranking speed)	130 PSI (896.4 kPa)	Fuel Pump Pressure	3-1/2 - 4-1/2 PSI (24.1 - 31.0 kPa)
Maximum variation between cylinders	20 PSI (137.8 kPa)	H. P.	107 (79.8 Kw) @ 2400 RPM
Firing Order	1-5-3-6-2-4	Torque	235 ft-lb (319.6 N·m) @ 1600 RPM
Spark Plug	AC-R46TS	Capacities	
Spark plug gap	.033 – .038 in. (0.838 – 0.965 mm)	Cooling System	13.0 U.S. quarts (12.3 L)
Torque	15 ft-lb (20.4 N·m)	Crankcase (w/o filter)	4 U.S. quarts (3.78 L)
Distributor	(Breakerless HEI – High Energy Ignition)	Power steering pump reservoir	3 U.S. quarts (2.84 L)
Ignition Timing	10° BT DC @ 550 RPM (idle)		

PARKMASTER FRAME SPECIFICATIONS

Cutting Units:	Seven (7)	
Hydraulic lift for raising and lowering all cutting units:	1st, 2nd and 4rd cutting units operate together. Cutting units 4-7 operate individually.	
Main Frame:	Structural reinforced welded and bolted construction.	
Wing Lift Arms:	Tubular steel, reinforced welded construction.	
Hydraulic System: Pump:	<p>Gasoline Model: Gear type, 10 GPM (0.631 L/s) @ 1700 RPM, 1500 PSI (10 343 kPa), belt driven from engine crankshaft with matched set of two belts.</p> <p>Diesel Model: Gear pump with priority flow divider valve to operate the Parkmaster. Frame hydraulic system and the tractor power steering system. Pump directly coupled to front engine crankshaft pulley. A torque arm mounted in rubber cushions prevents pump from rotating. Total Pump Capacity 10.5 GPM (0.624 L/s) @ 1200 RPM and 1500 P.S.I. (10 343 kPa) Primary Flow Rate (power steering): 2.0 GPM (0.126 L/s), 1250 PSI (8 618 kPa) relief valve setting for power steering.</p>	
Reservoir:	7 quarts (6.62 L) capacity with spin-on 40 micron filter. Full flow includes by-pass with 11-18 PSI (75.8-124.1 kPa) pressure setting. Vent cap and breather including filter screen at oil fill port.	
Control Valves:	Heavy duty, directional control valves, parallel circuit, stack design. Cast iron valve bodies with hardened spools and plated for corrosion protection. Primary relief valve, non-adjustable type set at 1250 PSI (8618.8 kPa) maximum pressure. Relief valve prevents excessive pressure build-up in hydraulic system and safe guards the hydraulic pump and hoses.	
Hydraulic Cylinders:	Tie rod construction, 3-inch (76 mm) bore. (5 couple acting cylinders, three 12-inch (30.5 cm) stroke and two 10-inch (25.4 cm) stroke used on Parkmaster 7). Chrome plated rods 1-1/8-inch (28 mm) diameter. Precision finished bore in cylinder tubes.	
Hoses:	Hydraulic pressure lines strength exceeds maximum system pressure by factor of four.	
Tractor Tires: Front:	14 x 8 wheels with 9.50-14, 4-ply 1-l ribbed tires and tubes. Pressure – 22 P.S.I. (151.7 kPa).	
Rear:	<p>6.00 x 16 drop center, demountable, disc-type dual wheels with 7.50-16, 4-ply, R-3 tires and tubes. Valves have provision for liquid ballast. Pressure – 20 P.S.I. (137.8 kPa) for turf work; 22 P.S.I. (151.7 kPa) recommended for concrete or asphalt road surfaces.</p> <p>8.00-16, 6-ply, lawn and garden tires and tubes. Valves have provision for liquid ballast. Pressure – 20 P.S.I. (137.8 kPa) for turf work; 22 P.S.I. (151.7 kPa) for hard surfaces (optional).</p>	
Cutting Units:	Reelmaster mowers.	
Width of Cut:	Approximately 14-1/2 feet (4.42 m)	
Overall Width: Transport Position:	96 in. (2.44 m) with Reelmaster mowers w/rubber tires; 92 in. (2.337 m) w/iron	
Overall Length: Transport Position: Mowing Position:	<p>Approximately 188 in. (4.775 m)</p> <p>Approximately 177 in. (4.496 m)</p>	
Overall Height w/o Cab or Roll Bar: Transport Position:	66 in. (1.676 m)	
Weights* Total Weight:	<p>Gasoline, Model 33787 — 6240 lb (2830 kg) w/7 Reelmaster mowers.</p> <p>Diesel, Model 33677 — 6540 lb (2966 kg) w/7 Reelmaster mowers.</p>	
Front Axle: A. Transport Position: B. Cutting Position:	<p>Gasoline, Model 33787</p> <p>A. 1750 lb (794 kg)</p> <p>B. 1950 lb (885 kg)</p>	<p>Diesel, Model 33677</p> <p>A. 2010 lb (912 kg)</p> <p>B. 2210 lb (1002 kg)</p>
Rear Axle: A. Transport Position: B. Cutting Position:	<p>Gasoline, Model 33787</p> <p>A. 4450 lb (2018 kg)</p> <p>B. 2110 lb (957 kg)</p>	<p>Diesel, Model 33677</p> <p>A. 4490 lb (2036 kg)</p> <p>B. 2150 lb (975 kg)</p>

*Rear axle weights do not include liquid ballast in tires. 400-500 pounds (182-227 kg) can be added with ballast.

GENERAL ASSEMBLY INSTRUCTIONS

CUTTING UNITS

The PARKMASTER Tractor is shipped with frame completely assembled and serviced. The mowers and wheels for mowers must be installed to complete the unit. Assembly instructions for installing the wheels are included in the mower operators manual. It is generally easier to adjust mowers to the required height-of-cut prior to installing the mowers to the PARKMASTER frame.

flation pressure and tires matched so that the same diameter tires are installed on the same mower. If tires vary considerably in diameter, it will be impossible for the mower bedknife to be parallel with the ground and provide a uniform cut. Tire inflation is important and should always be maintained at the prescribed pressure.

Reelmaster mower tires — 35 P.S.I. (241 kPa).

MOWER TIRE INFLATION PRESSURE

If pneumatic tires are used on the mowers, it is important that the tires be inflated to the proper in-

LOOSE PARTS CHART

Loose Parts	Quantity	Description	Where Used
Operators Manual	1		
Parts Catalog	1		
Engine Handbook (Diesel)	1		
Engine Parts Manual (Diesel)	1		
Advice of Engine Sale Card (Diesel)	1		
Warranty Reg. Card (Diesel)	1		

ATTACHMENT OF MOWERS TO LIFT ARMS

PARKMASTER 7

Figures 1 through 7 show the correct attachment of mowers to lift arms at all positions for the Parkmaster 7 frame.

Your Parkmaster frame is equipped with safety chains. These chains should be used when the

cutting units are in the transport position, to prevent the mowers from accidentally being lowered when the tractor is traveling at high speeds. Figures 5 and 7 show the proper attachment to the mowers. The safety chains can be stored right on the frame when not being used.

NO. 1 POSITION

DOWN

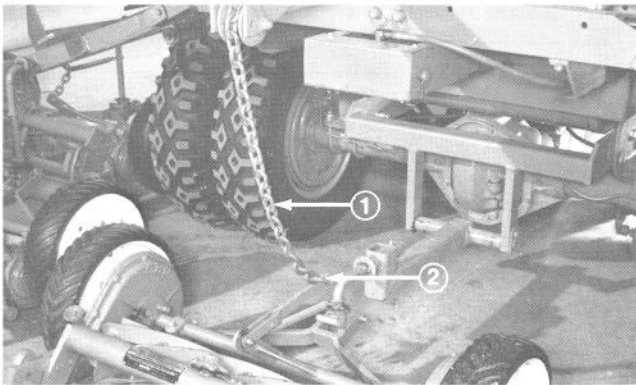

Figure 1

1. Slack lift chain 2. Long clevis

UP

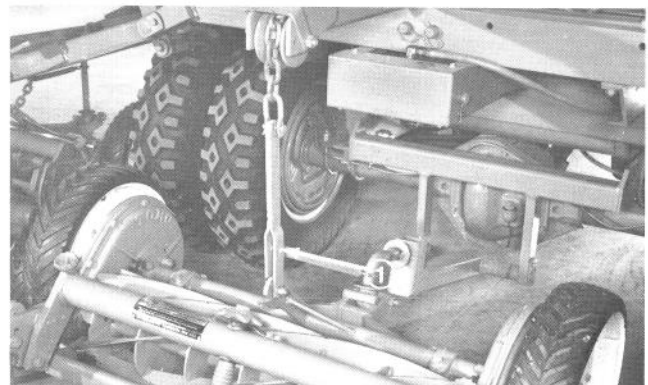

Figure 2

1. Spring mounting hole

NO. 2 & 3 POSITION

DOWN

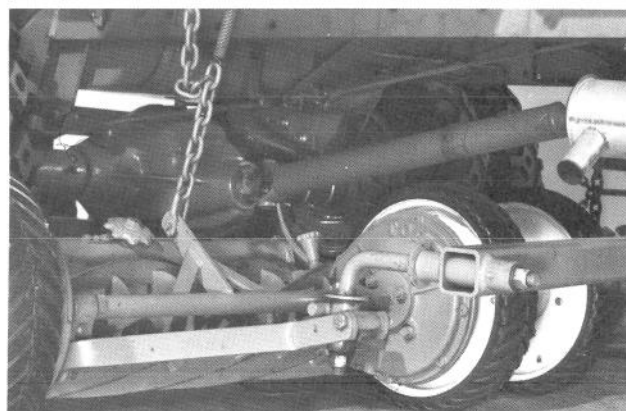

Figure 3

ATTACHMENT OF MOWERS TO LIFT ARMS

NO. 4 & 5 POSITION

Note: The inside wheel on #4 & 5 mowers may hit tractor frame when the mower is raised. If so, remove chain and twist it so that as the chain tries to straighten itself, it will rotate mower away from the frame.

DOWN

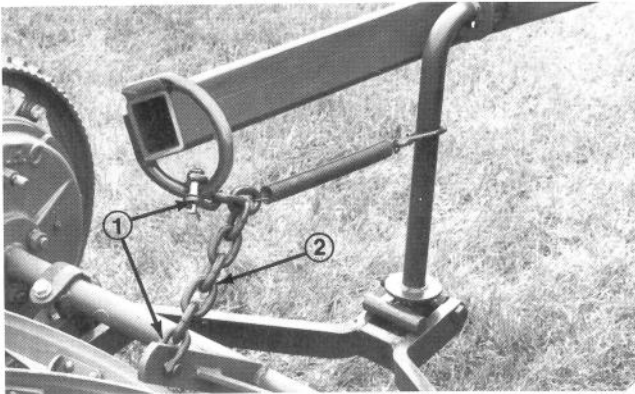

Figure 4

1. Short clevis 2. 7 links

UP

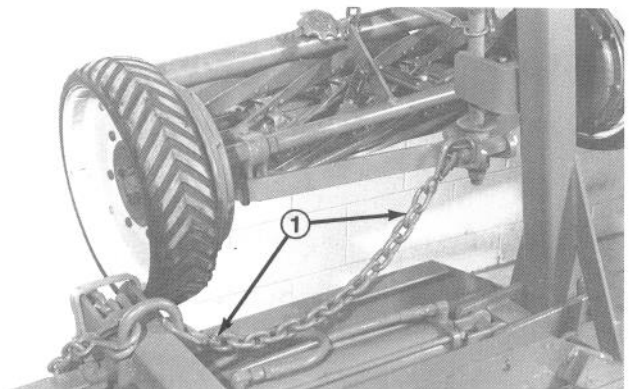

Figure 5

1. Safety chain

Hook spring in 3rd to 6th link from bottom.

NO. 6 & 7 POSITION

DOWN

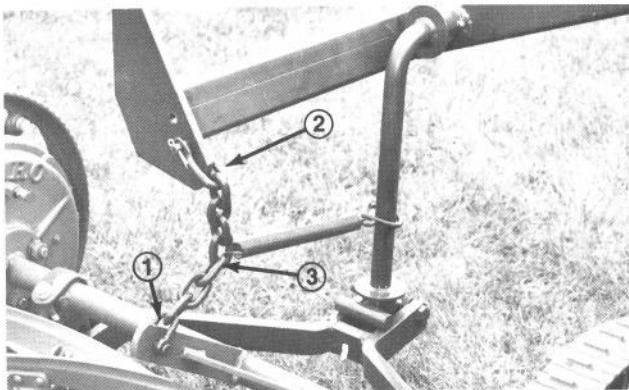

Figure 6

1. Short clevis 3. 7 links
2. Long clevis

UP

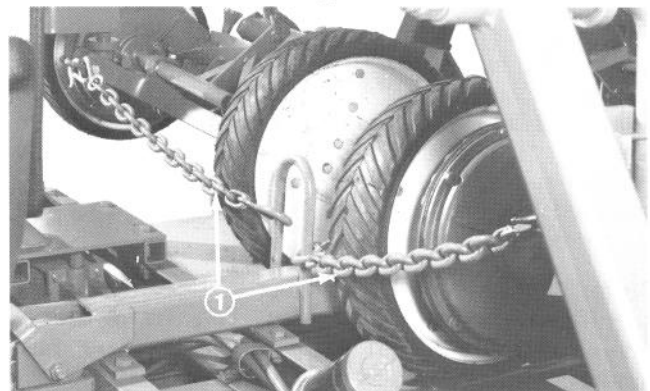

Figure 7

1. Safety chain

Hook spring in 3rd to 6th link from bottom.

BEFORE OPERATION

The following procedures should be performed prior to initial operation to achieve long life and trouble free performance:

Note: Subjects pertaining to either a gasoline or diesel engine tractor alone will be identified by the words "gasoline" or "diesel." Subjects without this identification pertain to both the gasoline and diesel engine tractors.

CHECK ENGINE CRANKCASE OIL (Gasoline)

To maintain the oil at the proper level, check it prior to starting the engine or as the last step in a re-fueling operation.

1. Position the machine on a level surface.
2. Disengage the hood latches and open the hood. Use the hood prop rod to keep the hood open.
3. Remove dipstick and wipe it with a clean rag. Re-insert the dipstick fully into the tube and remove it again. Visually check the level indicated on the dipstick. A "FULL" and "ADD OIL" mark is stamped into the dipstick. The correct level is when the oil is at the "FULL" mark. The area between the "FULL" and "ADD OIL" marks is the safety margin. Never allow the level to fall below the "ADD OIL" mark or fill to a level above the "FULL" mark. Reseat the dipstick firmly after taking the reading.
4. The crankcase capacity is 4 U.S. quarts (3.78 L) 5 quarts (4.73 L) when the filter is replaced. The oil filler cap is located on the rocker arm cover.
5. Use only engine oil which meets the GM-6041-M (SE) or (SF) standard. High quality oils intended for service SE or SF which pass automobile manufacturers tests are of this quality. The dipstick is marked "Use GM-6041-M Quality SE Oil", as a reminder to use only high quality oils as prescribed. The new engine warranty and the oil change interval recommended are based on the use of oils which meet these requirements.
Note: Non-detergent and other low quality oils are specifically not recommended. The use of proper engine oils and oil change intervals are your best assurance of continued reliability and performance from your engine.
6. The normal oil change interval is after every 60 hours operation. However, the oil should be changed at proportionately shorter intervals if the engine is subjected to the following types of severe service:

- A. Operation under extremely dusty conditions.
- B. Extensive idling.

- C. Stop and go type operation.
- D. Extended operation at high ambient temperatures and/or at high engine speeds.
- E. Short trip operation at freezing temperatures (engine not thoroughly warmed up).

7. Match the viscosity of the oil according to the ambient temperature which will be encountered during operation. Use the following chart as a guide in selecting the proper oil viscosity.

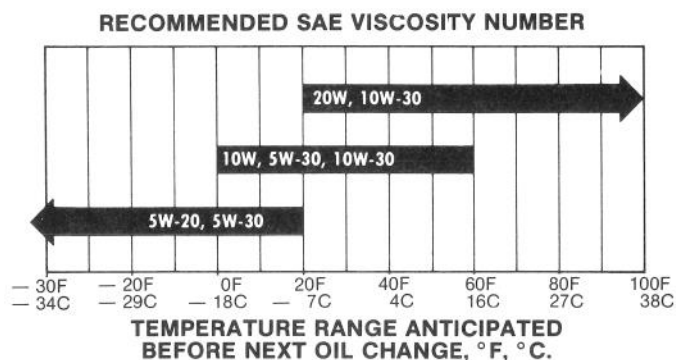

Figure 8

Note: SAE 5W-20 oils are not recommended for sustained high speed operation. SAE 30 oils may be used at temperatures above 40°F (4°C).

Note: See the Engine Maintenance section and the Service Interval Chart for proper maintenance practice during operation.

CHECK ENGINE CRANKCASE OIL (Diesel)

Use items 1 through 3 of the Check Engine Crankcase oil (gasoline) section, page 14, for proper oil check procedures. Add oil, if necessary. The crankcase oil capacity is 9 quarts (8.52 L). Perkins Engines approves the use of multi-viscosity oil provided it meets MIL-L-2104B or MIL-L-2104C specifications. MIL-L-2104B is equivalent to SAE CC grade oil rated for moderate duty applications. MIL-L-2104C is equivalent to SAE CD grade oil rated for severe duty diesel applications.

It is recommended that multi-viscosity oils be used to assist cold weather starting procedures and straight weight oils in areas where warmer temperatures are predominant.

CHECK COOLING SYSTEM

The cooling system is filled at the factory with a 50-50 solution of ethylene glycol antifreeze and water.

BEFORE OPERATION

Check the coolant level before starting the engine. Use this procedure every day prior to beginning operation. The capacity of the system is 13 U.S. quarts (12.3 L) for gasoline tractors, 16 U.S. quarts (15.14 L) for diesel.

1. Carefully remove the radiator cap.
2. Check level of coolant in radiator. Level of coolant must be above the core and approximately 1 inch (25 mm) below the bottom of the filler neck.
3. If coolant level is low, replenish the system. **DO NOT OVER FILL.**
4. Install the radiator cap.

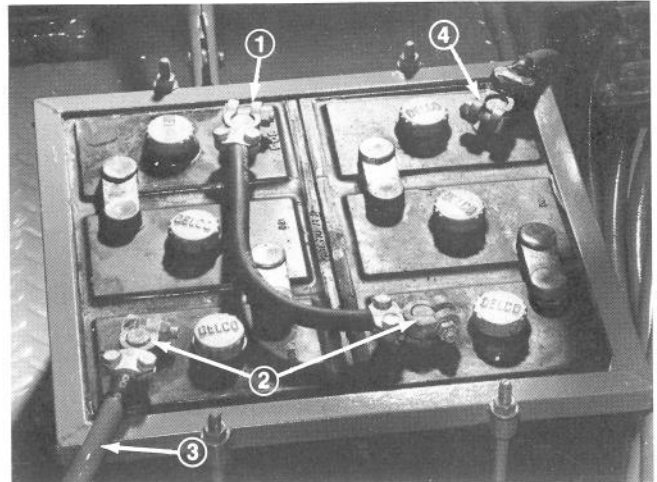

Figure 10

- | | |
|-------------|---------------|
| 1. Positive | 3. To ground |
| 2. Negative | 4. To starter |

CHECK THE BATTERY (Gasoline) – BATTERIES (Diesel)

The electrolyte level in the battery and the cable connections should be checked prior to operation.

Two 6-volt, heavy duty batteries, connected in series, are used on the diesel tractor. The batteries provide 12-volt negative ground service.

1. Remove the cover over the battery.
2. Remove the filler caps to check level.
3. The electrolyte should be above the plates but not above the fill ring at the bottom of the fill hole. Add distilled water to eliminate impurities if the electrolyte level is below the top of the plates.
4. Replace the filler caps.
5. Check the cable connections for tightness and the routing of the cables to prevent cable wear and damage.

Note: See Figure 9 (gasoline) and Figure 10 (diesel) for proper battery placement in the carrier and proper cable installation.

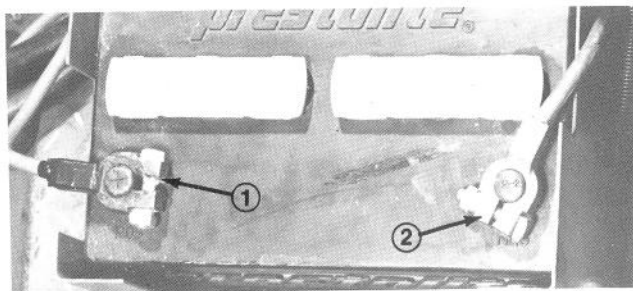

Figure 9

- | | |
|---------------------------|-------------------------|
| 1. Positive (to solenoid) | 2. Negative (to ground) |
|---------------------------|-------------------------|

FILL FUEL TANK WITH UNLEADED REGULAR GASOLINE (Gasoline)

(See Fuel Requirements section under Operating Instructions, page 22).

FILL FUEL TANK WITH DIESEL FUEL (Diesel)

(See Fuel Requirements section, page 22).

CHECK POWER STEERING PUMP (Gasoline)

The fluid level and the belt should be checked to provide trouble free operation and maximum performance. The oil should be warm before checking.

1. Remove the cap from the reservoir.
2. The fluid level mark is indicated on the dipstick.
3. Add only Type "A" Suffix "A" automatic transmission oil if the level is too low.
4. Securely install the cap.
5. Check the power steering belt tension with a spring scale. There should be 11/64 inch (4.4 mm) deflection with a 6-7 pound (2.7 - 3.2 Kg) pull midway in the longest span between the pulleys.
6. If belt is not properly tensioned, loosen the pump mounting bolts. Pry upward on the pump to tighten the belt and retighten the bolts.

BEFORE OPERATION

CHECK THE ALTERNATOR BELT (Gasoline)

The alternator belt should not be too loose or too tight. A loose belt will slip, thus reducing the speed of the alternator and fan. A tight belt will impose an unnecessary load on the fan and alternator bearings.

1. Use a spring scale on the belt midway in the longest span.
2. Apply a force (pull) of 4-5 pounds (1.8 - 2.3 Kg) and measure the belt deflection. There should be 1/4 inch (6 mm) deflection.
3. If belt deflection is inaccurate, loosen the alternator mounting bolts and rotate the alternator to attain the proper tension. (Fig. 11).
4. Retighten the mounting bolts.

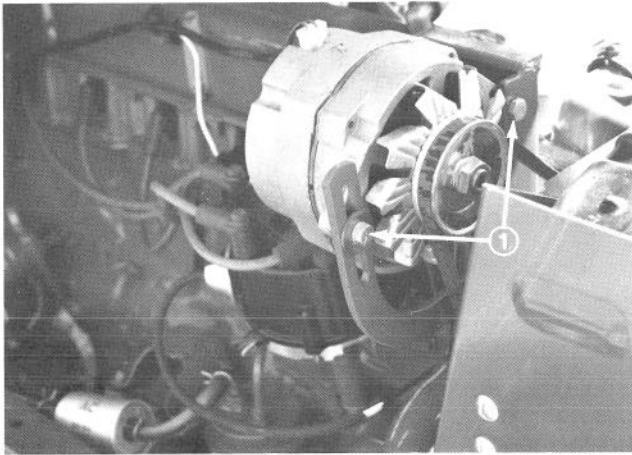

Figure 11

1. Alternator mount bolts

CHECK FAN AND ALTERNATOR BELT (Diesel)

The fan and alternator belt must be kept tight enough to drive the fan, water pump and alternator at their proper speeds, but not so tight as to impose an unnecessary load on the bearings.

To adjust, loosen the pivot bolt and the capscrew through the adjusting strap. Pull the alternator outward to tighten the belt. Adjust until the belt deflects about 3/8 in. (10 mm) midway between the alternator and crankshaft pulleys, with a force of approximately 10 pounds (4.5 Kg) applied (Figure 12).

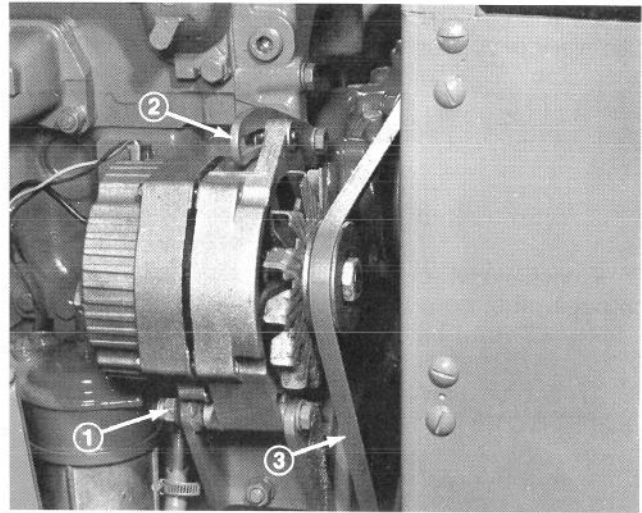

Figure 12

1. Loosen to adjust
2. Adjusting strap
3. 3/8 in. (10 mm) deflection at mid-span

CHECK THE PARKMASTER HYDRAULIC SYSTEM

The oil level and the hydraulic pump belt tension should be checked prior to operation.

Note: Use items 1 through 5 for diesel tractors, all items for gasoline tractors.

1. Run the engine for a period to warm the system oil.
2. Turn the engine off. Use a 9/16 in. wrench to free the dipstick.
3. The dipstick has two marks. The oil should be midway between the two marks when the cutting units are in transport position.
4. Remove the breather cap and add SAE 10W-30 or 10W-40 SE or SC engine oil to Gasoline Tractors, add Type "A", suffix "A", Automatic Transmission Fluid to Diesel Tractors, if the level is below the bottom mark on the stick.
5. Reinstall the breather cap and dipstick.
6. Use a spring scale to check the adjustment of both belts for the hydraulic pump (Gasoline tractor).
7. Apply a force of 6-7 pounds (2.7 - 3.2 Kg) midway in the span and check the deflection. There should be 1/8 inch (3 mm) deflection on both belts.

BEFORE OPERATION

8. If either belt needs adjustment, loosen the pump mounting bracket bolts. Use a pry bar on the side of the pump closest to the slotted hole in the pump bracket. Pry the pump downward to achieve proper belt tension and tighten the mounting bolts (Figure 13).

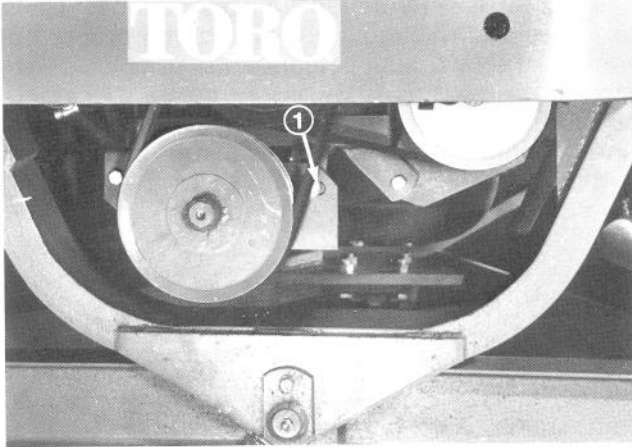

Figure 13 (Gasoline)

1. Loosen to adjust belts

CHECK HYDRAULIC BRAKE FLUID

The fluid level in the master cylinder should be checked prior to operation.

1. The master cylinder is located under the floor panel on the left side. A hole is cut in the panel for access to the master cylinder cap (Figure 14).

2. Remove the cap.

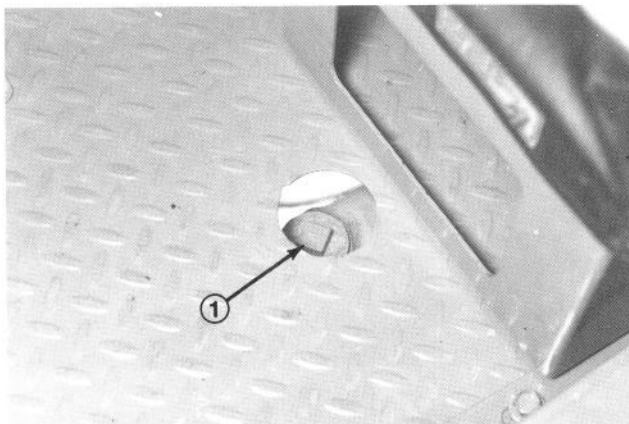

Figure 14

1. Master cylinder cap

3. The level should be approximately 1/4 inch (6 mm) below the bottom of the threads in the fill hole.

4. Add fluid if necessary.

5. Insure the vent holes in the cap are open and install the cap.

CHECK TRANSMISSION FLUID LEVEL

The transmission is filled with SAE 90 EP Gear Oil at the factory. However, check the fluid level prior to operation.

1. Place the tractor on a level surface.

2. Remove the filler plug and check the fluid level (Figure 15).

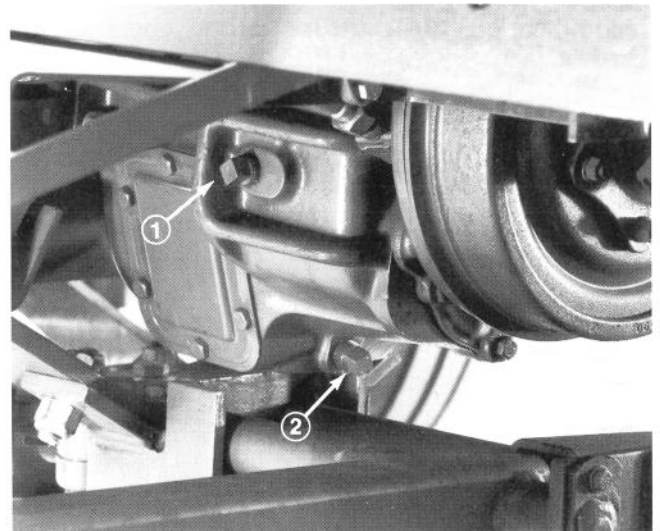

Figure 15

1. Filler plug
2. Drain plug

3. The oil should be to the bottom of the fill hole.

4. Add SAE 90 EP Gear Oil if necessary and replace the filler plug.

CHECK REAR AXLE FLUID

The axle is filled with SAE 90 EP Gear Oil at the factory. However, check the fluid level prior to operation.

1. Place the tractor on a level surface.

2. Remove the filler plug from the pipe elbow located in the rear axle cover and check the fluid level.

BEFORE OPERATION

3. The oil should be to the bottom of the threads for the filler plug in the pipe elbow.
4. Add SAE 90 EP Gear Oil, if necessary, and replace the filler plug.

CHECK TIRE PRESSURES

Keep the tires inflated as follows for turf mowing operation:

Rear:

7.50-16 20 PSI (137.8 kPa)

Front:

9.50-14 22 PSI (151.7 kPa)

Note: The tubes are equipped with valves for liquid ballast if desired. See page 25. Refer to page 10 for recommended tire pressure during operation on hard surfaces.

CHECK TORQUE OF FRONT AND REAR WHEEL NUTS AND BOLTS

The front wheel bolts and rear wheel nuts should be checked with a torque wrench. Insure the front

wheel bolts are torqued to 40-60 ft-lb (54-81 N·m) and the rear dual wheel nuts are torqued to 130-180 ft-lb (176-244 N·m).

GREASE TRACTOR AND HYDRAULIC FRAME

The tractor and hydraulic frame should be greased to insure against premature failure and proper operation of all working components. Use No. 2 General Purpose Lithium Grease to grease all components. Follow the guidelines listed in the lubrication section to assure all areas of the machine are covered.

VISUAL CHECK OF MACHINE

Visually inspect both the tractor and the hydraulic frame for loose, missing or improperly installed components. Also for signs of oil or other types of fluid leakage. Because of the complexity of this machine, it is wise to be both deliberate and thorough with your examination. Repair or correct any discrepancies you discover.

CONTROLS

FUEL GAUGE (Fig. 16)

The fuel gauge indicates the level of fuel in the remote fuel tank. It is located on the left side of the dash panel. The gauge registers from 0 to 15.5 gallons (0-59 L), E to F on gauge.

SPEEDOMETER – ODOMETER (Fig. 16)

Located in the dash panel, just above the steering column. The speedometer needle indicates ground speed in miles per hour. The odometer indicates total accumulated mileage.

TEMPERATURE GAUGE (Fig. 16)

Located at the right of the speedometer in the dash panel. Keeps the operator alerted to the operating temperature of the engine. The needle should register in the 240° F (116° C) range (gasoline) and 180° F (82° C) range (diesel) after the engine is

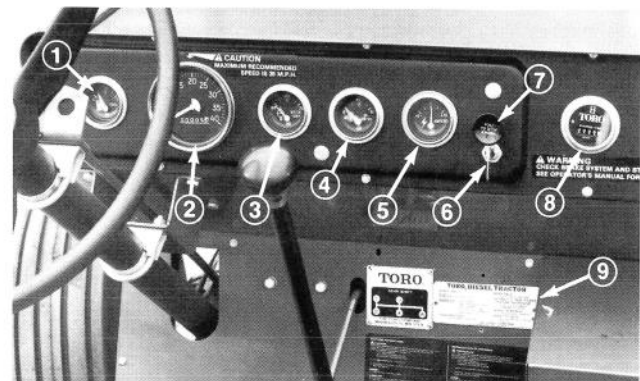

Figure 16

- | | |
|-------------------------|-----------------------|
| 1. Fuel gauge | 6. Ignition switch |
| 2. Speedometer-odometer | 7. Choke control |
| 3. Temp gauge | 8. Hour meter |
| 4. Oil pressure | 9. Model-serial plate |
| 5. Ammeter | |

thoroughly warm. If the needle moves to the HOT end of the gauge, stop the engine. Determine the cause and correct the overheating condition.

CONTROLS

OIL PRESSURE GAUGE (Fig. 16)

Located in the dash panel to the right of the temperature gauge. Indicates the oil pressure in the engine. Look at this gauge immediately after starting the engine. If there is little or no pressure indicated, stop the engine and determine the cause. Make any corrections necessary before restarting the engine.

AMMETER (Fig. 16)

Located to the right of the oil pressure gauge. Indicates the amount of charging current passing from the alternator to the battery. Normally indicates a slight charge unless the engine is idling slowly or will sometimes leave the needle centered on the gauge if the battery is fully charged. By contrast, a continuous discharge (—) reading above idle speed indicates a problem. Stop the engine, determine the cause and correct the problem.

IGNITION SWITCH (Gasoline) (Fig. 16)

The ignition switch is located to the right of the ammeter and is used to start and stop the engine. The switch has three positions; OFF, RUN and START. To start the engine, rotate the key fully clockwise. When engine starts, release the key. It will move automatically to the RUN position. Rotate the key counterclockwise to the OFF position to stop the engine.

STARTER SWITCH (Diesel) (Fig. 17)

The starter switch is located to the right of the ammeter and is used to start the engine. The switch has three positions; OFF, RUN and START. To start the engine, rotate the key fully clockwise. When engine starts, release key. Key will move automatically to the RUN position. **Note:** Engine will run with key in OFF position. However, key must be turned to RUN position to actuate Fuel Gauge, Temperature Gauge, Oil Pressure Gauge, Hour Meter and lights. Refer to Starting/Stopping Engine (diesel) page 23 for more complete instructions.

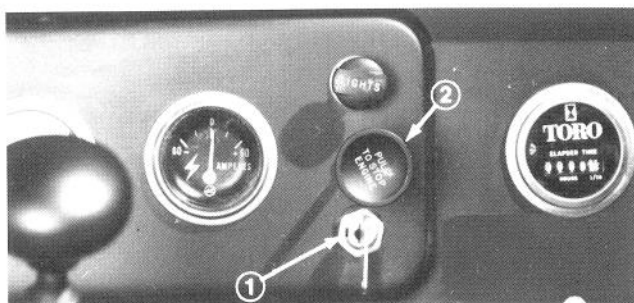

Figure 17 (Diesel)

1. Starter switch 2. Fuel shut-off

FUEL SHUT-OFF CONTROL (Diesel) (Fig. 17)

Located above starter switch. Pull out to stop engine. Push in after engine stops, rotate key to OFF position and remove key.

CHOKE CONTROL (Gasoline) (Fig. 16)

The manual choke control is located just above the ignition switch. To start a cold engine, pull the control fully out. Depress choke control approximately half way after engine starts and allow engine to warm up. Fully depress choke control when engine is warm.

HOUR METER (Fig. 16)

Located on far right side of dash panel. Registers actual hours of engine operation. Operates whenever ignition switch is in RUN position. Useful aid for determining proper intervals for lubrication and maintenance procedures.

SERIAL NUMBER PLATE (Fig. 16)

Located to lower right side of dash panel. Use Model and Serial Numbers from plate whenever ordering parts or obtaining service information from local Toro Distributor.

CLUTCH PEDAL (Fig. 18)

Left pedal on floor panel. Must be fully depressed to disengage clutch when starting engine and when shifting transmission gears. Release pedal slowly when transmission is in gear to prevent unnecessary wear on clutch and other related parts.

Note: Do not ride clutch during operation. Clutch pedal must be fully out or clutch will slip causing friction and wear.

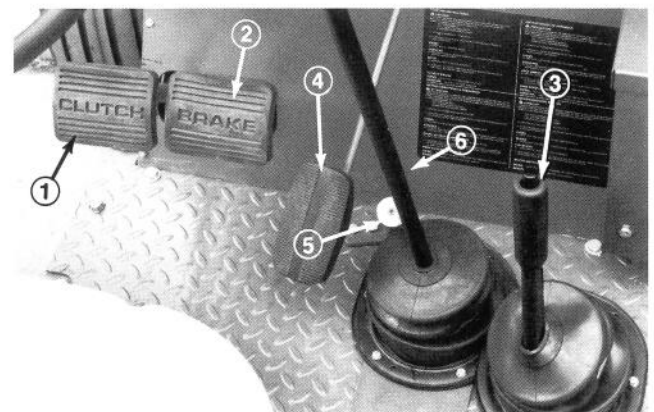

Figure 18

1. Clutch pedal 4. Accelerator pedal
2. Brake pedal 5. Adjustable foot rest
3. Parking brake lever 6. Shift lever

CONTROLS

BRAKE PEDAL (Fig. 18)

Located to right of clutch pedal. Use to apply hydraulic service brakes located in rear wheels.

PARKING BRAKE LEVER (Fig. 18)

Located on right side of floor panel next to battery case. Pull lever rearward to lock rear wheel brakes. Depress button and push lever forward to release. Always lock brake before leaving machine.

ACCELERATOR PEDAL (Fig. 18)

At right side of brake pedal. Used to open and close throttle valve (gasoline) or vary injection pump output (diesel) to vary engine and ground speed when transmission is in gear. Pedal will override the hand throttle setting if tractor is equipped with optional governor kit (with hand throttle control). Will increase ground speed if tractor is operating at less than maximum ground speed. Machine will return to original hand throttle setting when pedal is released.

ADJUSTABLE FOOT REST (Fig. 18)

Located alongside accelerator pedal. The adjustable foot rest is used in conjunction with the accelerator pedal and helps you maintain a predetermined engine speed. Your foot can rest partly on the accelerator pedal and partly on the rest.

Adjust the rest so you can comfortably hold the engine speed at approximately 1650 RPM. This will provide a ground speed of approximately 6 MPH (9.7 Km/hr) in 2nd gear, the optimum speed and gear for most mowing operations.

To increase the ground speed, merely slide your foot to the left (off the rest), and depress the pedal further.

GEAR SHIFT LEVER (Fig. 18)

Depress the clutch pedal and shift into the desired gear selection. The following recommendations show which gear should be selected to correctly perform various tractor applications.

Note: See Mower Manual for recommended ground speed.

FIRST GEAR: Use for jobs requiring slow speed or for heavy cutting. Tractor must be stopped when shifting into this gear.

SECOND GEAR: The principal gear for all gang-mower work. Most operations will be in this gear.

THIRD GEAR: A faster speed for light mowing operations. **DO NOT EXCEED 6 MPH (9.7 Km/hr).**

FOURTH GEAR: Transport



CAUTION

Reduce speed when encountering rough terrain and keep the vehicle under control at all times. At no time should maximum speed exceed 20 MPH (32 Km/hr.)

HYDRAULIC CONTROL VALVE (Figs. 19 & 20)

The control levers correspond to the cutting units. The center lever controls the center cutting units (Nos. 1, 2 & 3). The first lever to the left of center controls the No. 4 cutting unit, the first lever to the right of center controls No. 5 cutting unit, etc. See Figures 19 and 20. Pull on the levers to raise the cutting units, push to lower.

IMPORTANT: When raising or lowering mowers, hold the control lever until the cylinder is either fully extended or retracted. See page 25.

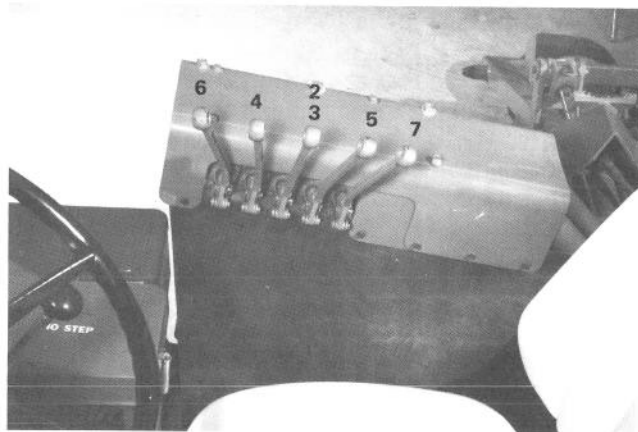

Figure 19

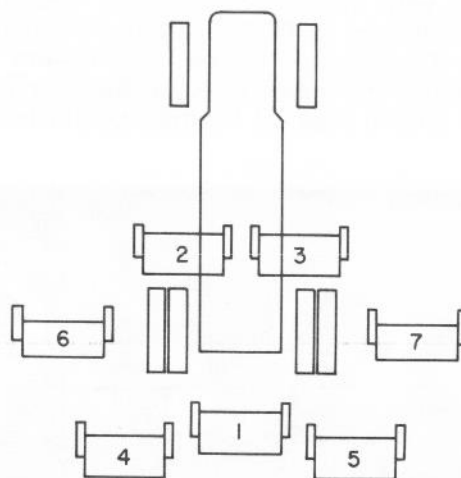

Figure 20

CONTROLS



CAUTION

Before raising or lowering cutting units, check to make certain that no one is near the units.

SEAT (Fig. 21)

The seat may be adjusted forward or rearward by pulling out the lever at the left side of the seat, sliding the seat to the desired position, and releasing the lever. The weight adjustment knob may be rotated to adjust for any operator's comfort. Adjust by sitting on seat and rotating weight adjustment knob until yellow indicator is flush with end of the pin.

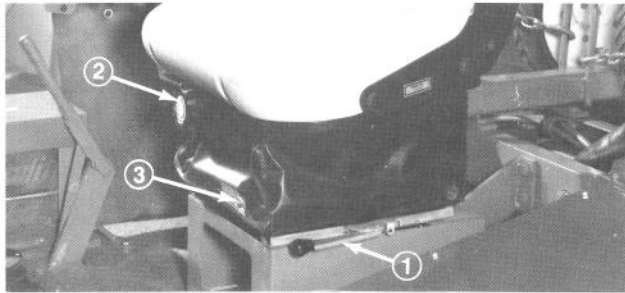

Figure 21

1. Positioning lever
2. Weight adjustment knob
3. Yellow indicator and pin

HAND THROTTLE – OPTIONAL KIT (Gasoline) (Fig. 22)

Hand throttle lever mounted on steering column.

Pull the throttle lever upward to increase speed; downward to decrease speed. The accelerator pedal can over-ride the hand throttle setting and increase speed if setting is at less than maximum speed. Speed will return to original hand throttle setting when pedal is released.

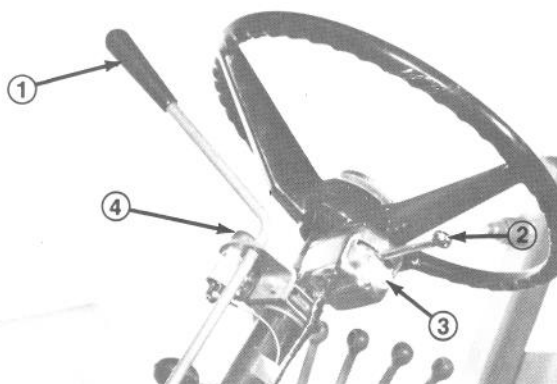

Figure 22

1. Hand throttle
2. Turn signal
3. Emergency (4 way) flasher switch
4. Horn button

IMPORTANT: Return the hand throttle downward all the way to the idle position before turning off the engine to prevent dieseling (gasoline engine).

LIGHT KIT CONTROLS – OPTIONAL KIT

A. Light Switch

Installed on dash panel above choke control. Pull out to activate headlights and taillights.

B. Headlights (Fig. 23).

To replace the headlights, disconnect the wires, remove four nuts and the retaining plate, and remove the lamp. Install the new lamp and connect the wires. The lights can be "aimed" to a small degree, by the method of tightening the nuts. Position the tractor on a level surface about 20 feet (6.1 m) from a wall, turn on the lights, and aim them for optimum effect.

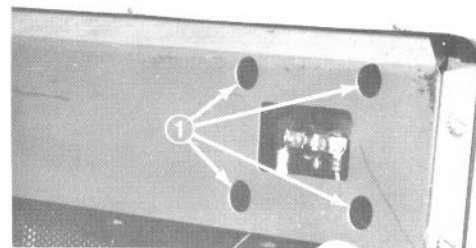

Figure 23

1. Access holes for mounting nuts

IMPORTANT: Do not tighten the capscrews too tight or you may break the lens.

C. Turn Signal Controller (Fig. 22).

Lever assembly located on left side of steering column.

To signal turn, move the lever in the direction of turn and release. The lever must be returned manually to the neutral position when the turn is completed.

D. Emergency Flasher Control (Fig. 22).

To activate the four directional signal lights pull out the red knob located on the directional signal lever housing. To turn off signals, turn the directional signal lever momentarily to one of the signalling positions, then return lever to the neutral position.

E. Slow Moving Vehicle Control.

To activate the four flashing amber lights, pull out switch knob located on the dash panel below oil pressure gauge and ammeter. Push knob in to turn signal lights off.

OPERATING INSTRUCTIONS

DAILY PRE-OPERATION CHECK

Check the following each day prior to beginning operation.

1. Coolant level in radiator.

Open the hood and remove the radiator cap to check level. Coolant should be kept approximately 1 inch (25 mm) below bottom of filler neck. Insure cap is firmly secured when it is installed.

2. Oil level in engine.

Remove dipstick, wipe it with a clean rag. Re-insert dipstick and again remove it. Oil should be to "FULL" mark. Add oil, if necessary. (See Engine Oil, gasoline, page 26, and diesel, page 27).

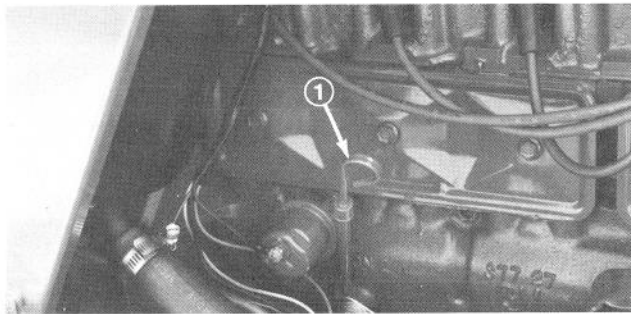

Figure 24 (Gasoline)
1. Dipstick

3. CHECK BRAKE OPERATION DAILY: REFER TO CHECKING BRAKE OPERATION, PAGE 22.

FUEL REQUIREMENTS

A. Gasoline Engine:

Your engine is designed to operate efficiently on fuel of approximately 91 Research Octane Number or higher, commonly sold in the United States and Canada. Use of fuel which is too low in anti-knock quality will result in "spark-knock" and/or "after-run". Since the anti-knock quality of all gasolines is not the same and factors such as altitude, terrain, and air temperature affect operating efficiency, knocking and/or "after-run" may result even though you are using the fuel recommended. If these conditions persist consult your Authorized Toro Distributor.

In any case, continuous or excessive knocking may result in engine damage and constitutes misuse of the engine for which "The Toro Company" is not responsible under the terms of the new engine warranty.

To obtain maximum results in the reduction of automotive emissions, use an unleaded regular gasoline.



DANGER

Because gasoline is flammable, caution must be used when storing or handling it. Do not fill fuel tank while engine is running, hot or when machine is in an enclosed area. Vapors may build up and be ignited by a spark or flame source many feet away. **DO NOT SMOKE** while filling the fuel tank to prevent the possibility of an explosion. Always fill fuel tank outside and wipe up any spilled gasoline before starting engine. Use a funnel or spout to prevent spilling gasoline before starting engine and fill tank to about 1 inch (25 mm) below the filler neck. Store gasoline in a clean safety-approved container and keep the cap in place on the container. Keep gasoline in a cool, well-ventilated place; never in an enclosed area such as a hot storage shed. To assure volatility, do not buy more than a 30 day supply of gasoline. Gasoline is a fuel for internal combustion engines; therefore, do not use it for any other purpose. Since many children like the smell of gas, keep it out of their reach because the fumes are explosive and dangerous to inhale.

B. Diesel Engine:

The most important single factor contributing to successful operation of a diesel engine is clean fuel, free of dirt and water. The clearances in the injection pump and the injectors are measured in tenths of thousandths of an inch, and the internal parts are lubricated by the fuel itself, so the need for clean fuel is apparent. The fuel must also be free of water. The engine is equipped with a fuel filter and a water trap. **THEY MUST BE SERVICED REGULARLY. SEE FIGURES 59 and 60.**

Use only No. 2 diesel fuel. **CONSULT THE PERKINS HANDBOOK FOR SUGGESTIONS ON HANDLING AND STORING DIESEL FUEL.** The Parkmaster tank capacity is 15-1/2 U.S. gallons (59 L). Clean filler cap and the spout before filling to prevent the entrance of dirt into the tank (Fig. 25).

A standpipe is provided at the fuel tank outlet fitting. This provision allows contaminants to settle to the bottom of the tank without being drawn into the engine. A drain port is located at the bottom of the tank to facilitate removal of foreign material. These features are also provided with the gasoline engine tractor.

OPERATING INSTRUCTIONS

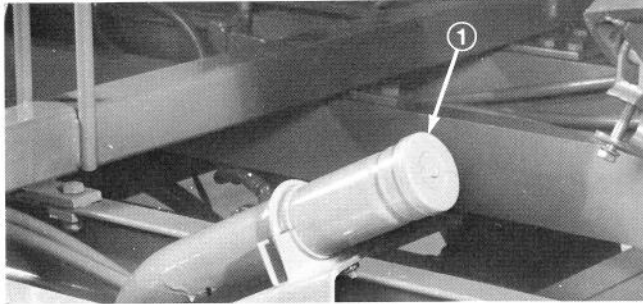

Figure 25
1. Filler cap

STARTING/STOPPING ENGINE (Gasoline)

1. Be sure parking brake is locked.
2. Depress clutch pedal and place shift lever in neutral.
3. Pull choke control fully out from dash panel and insert ignition key in ignition switch.

Note: Use choke only when engine is cold.

4. Continue to depress clutch pedal so interlock switch in starting circuit is activated and turn ignition key clockwise to START position. Depress the accelerator pedal about halfway. Release key immediately when engine starts and regulate choke to keep engine running smoothly.

IMPORTANT: Do not operate starter motor more than 30 seconds at a time without pausing to allow motor to cool for at least two minutes; otherwise, overheating and damage to motor may result.

5. Run engine at fast idle speed to allow engine to warm up faster prior to operation. Push the choke control fully in when engine is warm.
6. To stop engine, remove foot from accelerator pedal, depress clutch and shift transmission lever to neutral. Turn ignition key to OFF position and lock parking brake. Remove key from switch to prevent accidental starting.

STARTING ENGINE (Diesel)

1. Move the throttle lever to the mid-range position.
2. Make certain the fuel shut-off control is fully in.
3. Place all controls in neutral position and depress clutch pedal. An interlock switch is operated by clutch lever. The engine cannot be started unless clutch is disengaged.
4. Turn the key fully clockwise to the START position. As soon as the engine starts, release the key and allow it to return to the RUN position.
5. If the engine does not start after 15-20 seconds of cranking, release the starter and allow the fly-wheel to stop rotating and the starter to cool before engaging the starter motor again.

6. If engine must be started during cold temperature conditions, it is advisable to tow the tractor inside a warm building (above 32°F – 0°C) and allow engine to warm.

Note: Do not tow unit a great distance or transmission damage will result; refer to Emergency Towing Operation, page 26.

The tractor may also be started by towing with a second vehicle. This will reduce starter motor wear and battery drain.

STOPPING ENGINE (Diesel)

Pull out the fuel shut-off control and hold until the engine stops. **DO NOT RELEASE THE BUTTON UNTIL THE ENGINE IS COMPLETELY AT REST.** Return the button to the operating position (in), turn the key to OFF position and remove it from switch.

CHECKING BRAKE OPERATION

Check the brakes daily to make sure of proper performance. Leave the mowers, if so equipped, in transport position with safety chains installed and check brakes in a wide open, level area, free of obstructions and bystanders. The stopping distance for Class 'A' machines of this type is established by the Society of Automotive Engineers (SAE) J1041 recommended practice and American Society of Agricultural Engineers (ASAE) S365T (tentative) Standard. These standards require machines to stop in not more than 25 feet (7.6 m) from 15 mph (24 km/hr) by limiting the force on the brake pedal to a maximum of 200 lb (91 kg).

This information on stopping distance was derived from tests conducted with relatively new self propelled vehicles under optimum road conditions with skilled operators. The effectiveness of a brake system may be reduced with continued usage.

This vehicle will stop within 25 feet (7.6 m) from 15 mph (24 km/hr) with a brake pedal pressure of 50 lb (22.7 kg) when the brake system is properly maintained and adjusted. Stopping distance may be shorter when pedal force exceeds 50 lb (22.7 kg).



WARNING

The operating environment of this machine can cause stopping distance deterioration. It is, therefore, important that the stopping capabilities of the service brake system be checked daily. If the stopping distance degrades or the pedal force required to stop the vehicle becomes excessive, inspect, clean, repair or replace the parts before continuing to operate this machine. Remove brake drums and inspect the entire brake system every six months — repair, adjust, clean as necessary.

OPERATING INSTRUCTIONS

HYDRAULIC CONTROL PANEL

PULL TO RAISE
PUSH TO LOWER

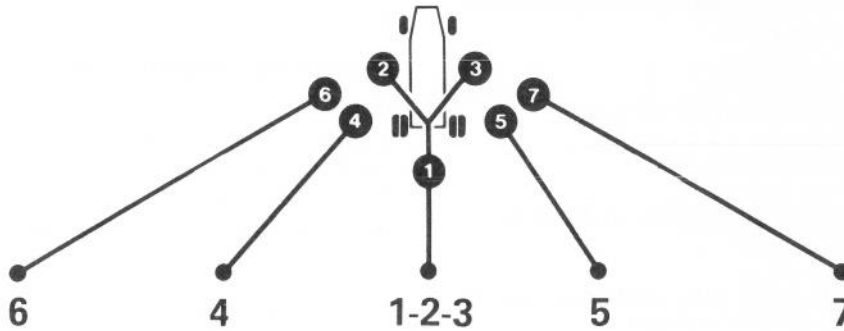

Figure 26

TRAINING OPERATION

Before mowing for the first time, practice operating your Parkmaster Tractor in a large, clear, level area. Start, stop, raise and lower mowers and maneuver the machine with all mowers down to develop skills necessary to keep control of the extreme outboard mowers to prevent hitting obstacles. Also, practice operating at transport speeds with mowers in transport position to achieve familiarity with all types of operating conditions.



CAUTION

Maximum recommended ground speed is 20 miles per hour (32 km/hr) where conditions permit.

MOWING OPERATION

1. Be sure all mowers are properly adjusted; height of cut, bedknife to reel, all mowers in gear. Consult the mower operators manual for proper adjustment procedures.
2. Approach area to be mowed with mowers in transport position with safety chains removed and tractor in second gear.
3. Push the hydraulic control levers toward the valve section to lower the mowers with Parkmaster in motion to eliminate possibility of spinning tractor drive wheels on the turf causing turf damage. Use the diagram on top of hydraulic control panel as a guide to lowering mowers (Fig. 26).

IMPORTANT: Make sure that no persons are working on or near the mowers before raising or lowering them. Hold control levers in until lift cylinder rods are fully extended. This allows cylinder rod link to clear pivot arm of lift arm enabling mowers to follow contour of terrain (Fig. 27). Relief valve will open when cylinder is fully extended. An audible sound will be heard indicating the lever can be released.

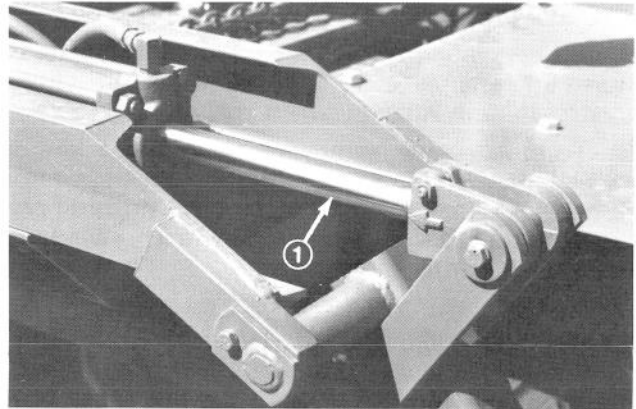

Figure 27

1. Cylinder rod fully extended

4. It usually works best to mow the outer portion of the area first, then work your way to the center. Down shift the tractor prior to climbing a steep incline to eliminate the need to downshift halfway up which could cause tire slippage and turf damage. Raise one or two outboard mowers until they are just clear of the turf to provide added weight to the drive wheels and reduce the power requirements if a condition occurs where sufficient power is lacking to climb a hill. Do not raise the mowers above halfway while operating on severe hillsides or tractor stability may be affected. For operating on

OPERATING INSTRUCTIONS

severe sidehills, partially raise one or two of the uphill mowers. This added weight to the uphill drive wheels will add stability to the tractor and prevent the upper drive wheel from spinning, thereby causing turf damage. Do not accelerate when making a turn on turf area. This will cause the rear dual tires closest to the center to spin out and damage the turf.



CAUTION

Do not operate the machine if one of the rear dual tires should become flat, as a single tire and wheel assembly cannot adequately support the weight of the machine. Should a rear dual tire become flat, stop the machine and either replace or repair the assembly; refer to Front and Rear Tire Repair, page 56.

5. Vary the mowing speeds to match the terrain conditions. Slow down in rough terrain conditions to keep the mowers from bouncing. Never exceed six miles per hour (9.7 km/hr). Traveling too fast can cause mechanical damage to the mowers and does not significantly increase the overall efficiency. Mowing at four to six miles per hour (6.4 to 9.7 km/hr) produces the finest turf appearance. Six miles per hour (9.7 km/hr) ground speed in second gear is the most economical and efficient speed and gear setting. The engine at approximately 1600-1650 RPM is operating at its maximum cutting power.

6. Reverse the direction of travel each time an area is mowed. This reduces a grain condition in the turf where the grass tends to grow in the direction of mower travel. Occasionally mowing at 90 degrees to the usual mowing direction will also contribute to reducing the condition.

7. Reduction in compaction of the soil and turf can be achieved by occasionally leaving one or two of the outboard mowers in the transport position while mowing the periphery of the mowing area. This offsets the tractor and mower wheel tracks from the previous mowing and prevents operating in the same path continuously. On golf courses, cross cut each end of the fairway at the tee and green to reduce the amount of travel at these locations. Considerable traffic is concentrated in these areas by golfers and carts. Any reduction in travel by the mowing equipment is beneficial to the turf.

INSPECTION AND CLEAN-UP AFTER MOWING

At the completion of mowing operation, thoroughly wash the machine with a garden hose without a nozzle so excessive water pressure will not cause contamination and damage to seals and bearings. After cleaning, it is recommended the machine be inspected for possible hydraulic fluid leaks, damage or wear to hydraulic and mechanical components and the cutting units checked for sharpness.

LIQUID BALLAST

If your Parkmaster will be used on extremely hilly terrain, it is advisable to add liquid ballast to the rear tires for increased traction. If the unit will not be subjected to freezing temperatures, plain water may be used.

The following chart provides data on filling tires with water and calcium chloride solutions, based on filling to valve level, or approximately 75% full.

Water Only			
Tire Size	Gallons	Pounds	
7.50-16	9 (34.07 L)	75 (34.02 kg)	
8.00-16 (Optional)	10 (37.85 L)	83 (37.19 kg)	
3-1/2 lb (1.6 Kg) CaCl ₂ Solution			
Tire Size	Gallons Water	Pounds CaCl ₂	Total Weight
7.50-16	8 (30.28 L)	28 (12.7 kg)	95 (43.09 kg)
8.00-16 (Optional)	9 (34.07 L)	32 (14.51 kg)	107 (48.53 kg)
5 lb (2.3 Kg) CaCl ₂ Solution			
Tire Size	Gallons Water	Pounds CaCl ₂	Total Weight
7.50-16	7.3 (27.62 L)	37 (16.78 kg)	98 (44.45 kg)
8.00-16 (Optional)	8 (30.28 L)	40 (18.14 kg)	106 (48.08 kg)

Either Type 1 (77%) or Type 2 (94%) commercial calcium chloride flake may be used. The chart is based on the use of Type 1 (77%). If Type 2 (94%) is used, reduce the weight of calcium chloride to be used by 25%.

Plain water freezes solid at 32° F (0° C). The 3-1/2 pound (1.6 kg) calcium chloride to one gallon (3.8 L) of water solution is slush free to -12° F (-24° C), and will freeze solid at -52° F (-46° C). The 5 pound (2.3 kg) per gallon (liter) solution is slush free to -50° F (-45° C) and will freeze solid at -62° F (-52° C).

Tires should be filled to approximately 75% capacity (valve level with valve at the top).

OPERATING INSTRUCTIONS

IMPORTANT: If a puncture occurs in a tire with liquid ballast, remove unit from turf area as quickly as possible. To prevent possible damage to turf, immediately soak affected area with water.

TRANSPORT OPERATION

1. Make sure that all mowers are in full transport position before moving to the next mowing area. Hold the valve lever until an audible noise is produced indicating the hydraulic cylinder has completed travel and the hydraulic relief valve has opened.

2. Install safety chains on the mowers to prevent them from swinging and causing damage to themselves and the tractor if the next mowing area is an appreciable distance away.



CAUTION

Driving through deep water may affect brake performance. Applying the brakes lightly will indicate whether they have been affected. To dry them quickly, lightly apply the brakes while maintaining a slow forward speed with an assured clear distance ahead until brake performance returns to normal.

3. Test the brakes by applying light pedal pressure prior to transport operation to make sure they have not been affected by wet turf conditions: refer to Checking Brake Operation, page 23.

4. Use fourth gear while transporting. Reduce speed in heavily populated or in hazardous conditions.



CAUTION

Never exceed 20 MPH (32 km/hr). Reduce speed and shift into a lower gear before descending a steep or long grade. Use the brakes sparingly to prevent overheating and reduction in brake effectiveness.

EMERGENCY TOWING OPERATION

IMPORTANT: If it is ever necessary to tow the PARKMASTER with another vehicle, it is very important that the drive shaft be removed before the unit is towed. Serious damage to the transmission could result if this precaution is not followed. Re-install per instructions on pages 43-44.

TRACTOR LUBRICATION MAINTENANCE

CHASSIS

Various components in the chassis assembly, including the engine, transmission, drive shaft and rear axle must be serviced with the proper lubricants at prescribed intervals. The intervals noted for each operation should be followed if the unit is operated under normal operating procedures. Shorten the time between maintenance intervals under more severe conditions.

ENGINE OIL (Fig. 28) (Gasoline)

1. Check the oil level daily with the tractor placed on a level surface. Drain and replace oil every 60 hours of normal operating conditions. Change the oil at proportionately shorter intervals if the engine is operated under the following conditions:

Dusty operating conditions.

Extensive idling.

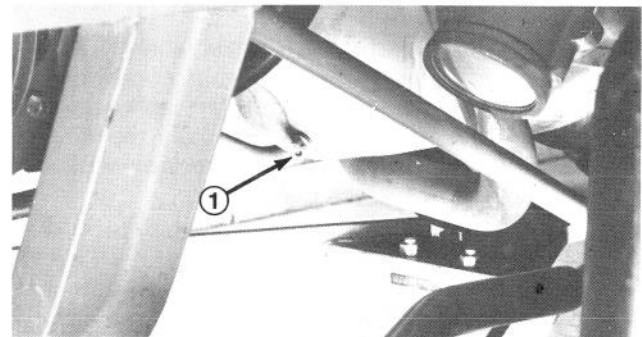

Figure 28
1. Drain plug

Extended high speed operation at high ambient temperature.

Stop and go type service.

Short trip operation at freezing temperatures (engine not thoroughly warmed up).

TRACTOR LUBRICATION MAINTENANCE

2. Use engine oil which meets GM-6041-M (SE) or (SF) standard only. High quality oils intended for service SE or SF and which pass car makers tests meet this standard. Add 4 U.S. quarts (3.78 L), 5 quarts (4.73 L) when changing the filter. Use the chart below as a guide in selecting the proper oil viscosity.

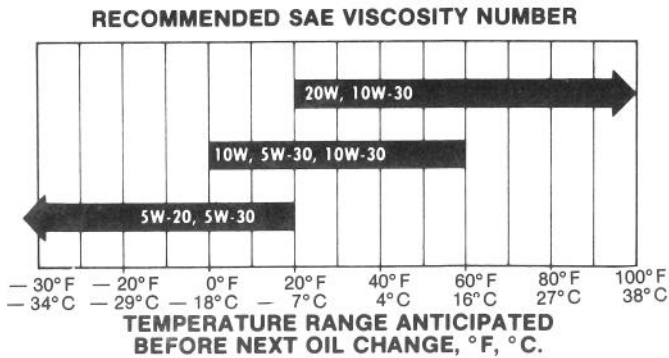

Note: SAE 5W-20 oils are not recommended for sustained high speed operation. SAE 30 oils may be used at temperatures above 40° F (4° C).

ENGINE OIL (Fig. 29) (Diesel)

1. Place the tractor on a level surface and check the oil level daily. Drain and refill the crankcase (9 quarts [8.52 L]) after the first 25/50 hours of operation and every 200 hours or four months thereafter if the tractor is operated under normal conditions. Change oil more frequently under abnormal conditions.

2. Refer to Check Engine Crankcase Oil (Diesel), page 15 for proper oil recommendations.

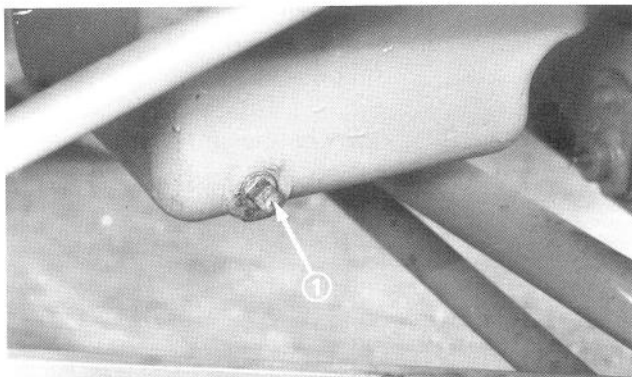

Figure 29
1. Drain plug (Diesel)

ENGINE OIL FILTER (Gasoline)

1. Replace the filter at the first oil change and every other oil change thereafter. (120 hour intervals). These recommendations are based on the use of recommended engine oils and a high quality filter.

2. Apply a thin film of clean oil to the filter sealing gasket and be sure the mounting surface on the engine is clean. Mount the filter by turning it until it contacts the base, then turn it one turn further.

3. Add oil to the engine. Five quarts (4.73 L) with filter (Fig. 30).

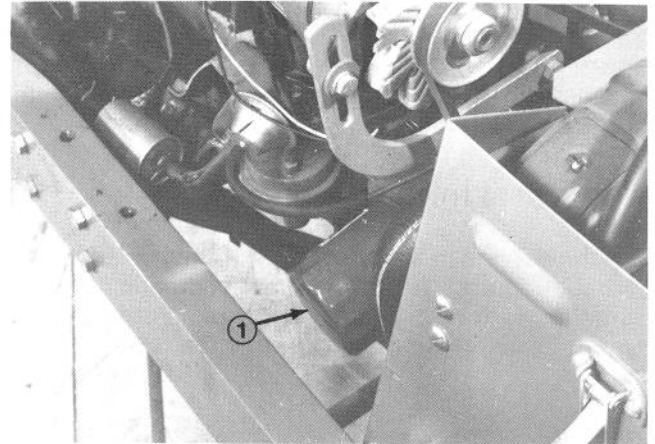

Figure 30
1. Engine oil filter

4. Start the engine and check for leaks.

ENGINE OIL FILTER (Diesel)

Replace the oil filter after the first 25/50 hours of operation and every 200 hours thereafter. Consult the Perkins Engine Handbook for proper procedures. Fill the new filter with oil prior to installation.

POWER STEERING (Gasoline)

Keep the power steering system clean to be sure of maximum operating performance and trouble-free service.

1. Check the fluid level every 200 hours of operation. Clean the area around the filler cap before removing the cap. The full mark is indicated on the dipstick (Fig. 31).

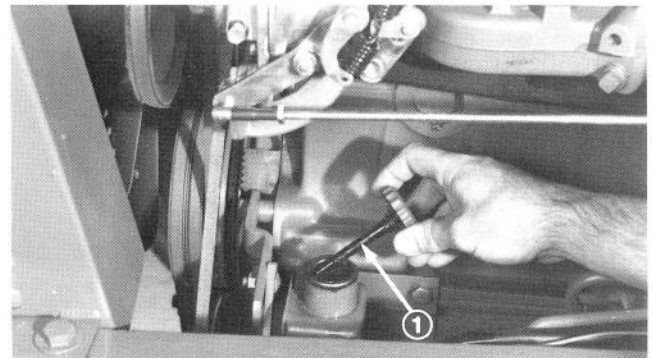

Figure 31
1. Dipstick

TRACTOR LUBRICATION MAINTENANCE

2. Use type "A" suffix "A" automatic transmission oil if the level is low.
3. Visually inspect lines, fittings, pump and steering gear for leakage. Repair if necessary.
4. The slightest evidence of dirt, sludge or water discovered in the system is an indication the system oil should be drained and replaced. Drain by disconnecting the return line (Fig. 31). Run the engine at idle until the oil is completely drained. Shut the engine off, replace the line and refill the system to the proper level.

POWER STEERING (Diesel)

The power steering pump is combined with the hydraulic pump for the frame hydraulic system. Refer to Hydraulic System and Frame Lubrication maintenance section, page 30, for service procedures.

GREASING FRONT AXLE, STEERING LINKAGE, WISHBONE PIVOT, DRIVE SHAFT UNIVERSAL JOINTS AND CLUTCH AND BRAKE PEDAL BUSHINGS.

Tools Required: Clean rag and two Grease Guns, one filled with No. 2 General Purpose Lithium Grease and the other with 0 or 00 Grease.

Grease the eleven fittings on the above listed items every 200 hours or more frequently under severe operating conditions. Wipe each fitting with a clean rag and make sure the tip of the grease gun is clean before greasing so that dirt is not forced into the bearings or bushings. Apply grease until the used lubricant is forced out and clean grease is evident. Wipe the old grease away so it will not attract more contamination.

1. Use No. 2 Lithium Base Grease on the following lubricating points: Front Axle Pivot (Fig. 31); Front Axle Spindle Bearings, Left Hand and Right Hand (Fig. 33), Left and Right Hand Tie Rod Ends (Fig. 33), Front and Rear Drag Link Tube Ball Sockets (Fig. 33, 34), Wishbone Pivot Point (Fig. 35); Clutch and Brake Pedal Bushings (Fig. 37). Under floor panel on left hand side.

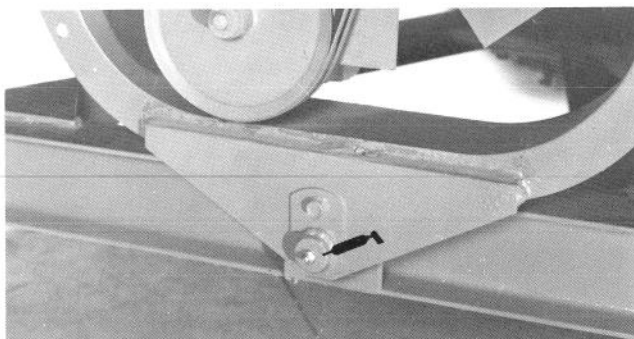

Figure 32

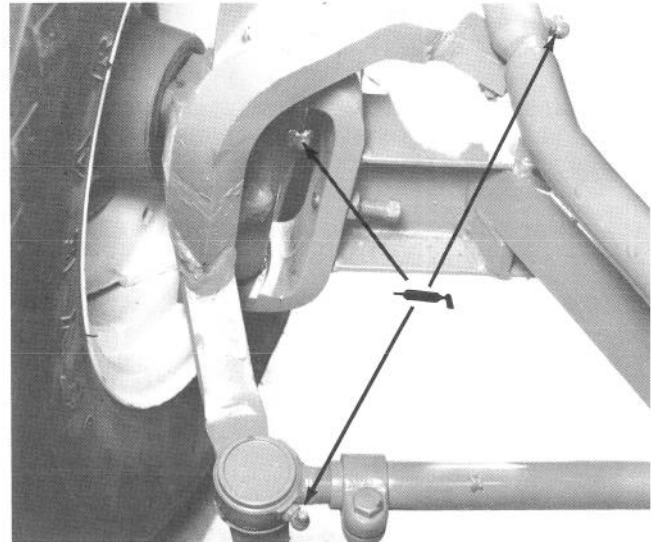

Figure 33

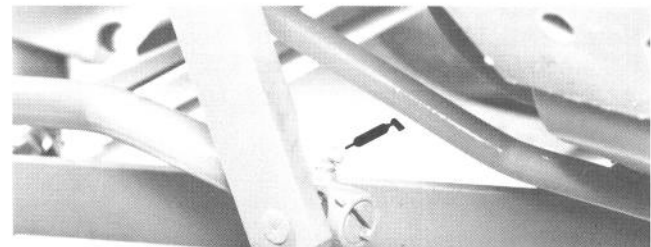

Figure 34

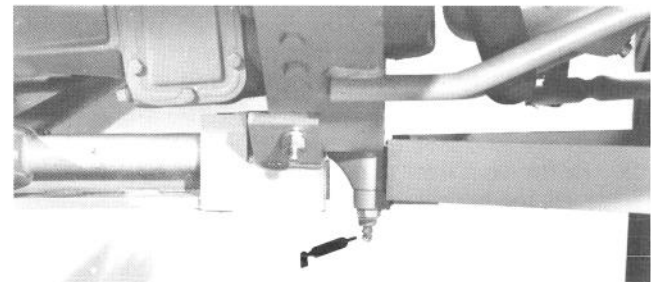

Figure 35

2. Use 0 or 00 Grease in the universal joints on each end of the drive shaft (Fig. 43).

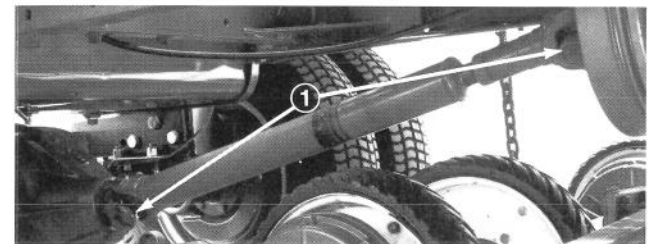

Figure 36

1. 0 or 00 grease

LUBRICATING CLUTCH, HAND BRAKE, CARBURETOR AND OPTIONAL GOVERNOR LINKAGE.

Tools Required: Two Oil Cans. One filled with SAE 30 Engine Oil, the other with SAE 10 Engine Oil.

TRACTOR LUBRICATION MAINTENANCE

1. The clutch linkage should be lubricated with SAE 30 engine oil every 600 hours (Fig. 37).

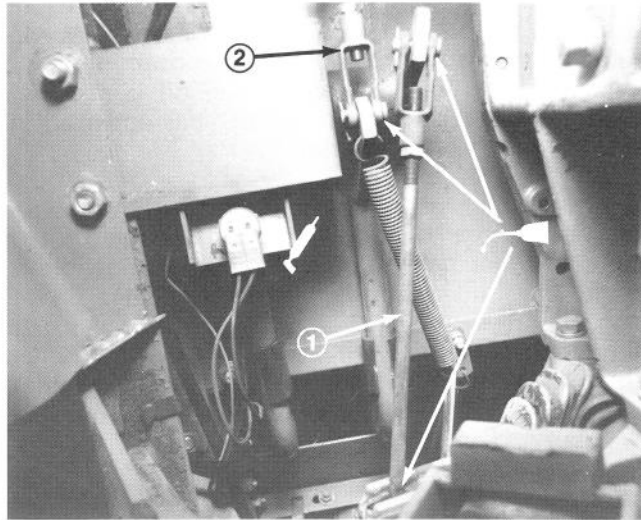

Figure 37

1. Clutch linkage 2. Hand brake linkage

2. The hand brake linkage should be lubricated with SAE 30 engine oil every 200 hours.

3. The carburetor and optional governor linkage should be lubricated with SAE 10 engine oil every 200 hours.

TRANSMISSION

Every 1200 hours of operation, place the tractor on a level surface, drain the oil and flush the case with kerosene or diesel fuel (Fig. 38). Use SAE 90 EP Gear Oil in the transmission case. The capacity is 7 pints (3.31 L). Fill to the level of the filler plug.

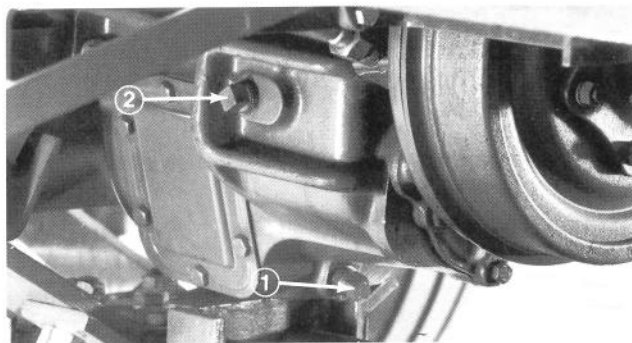

Figure 38

1. Drain plug 2. Filler plug

REAR AXLE

Use SAE 90 EP Gear Oil in the rear axle. Check level every 200 hours; add oil if required. Every 1200 hours of operation, place the tractor on a level surface, drain the oil and flush the case with kerosene

or diesel fuel. Drain the axle by removing the rear carrier cover. Replace the cover gasket before reinstalling the cover. Torque the cover bolts to 30-40 ft-lb (41 - 54 N·m). Wash the breather in a solvent at the time of changing the oil in the rear axle. Make certain the breather cap is free to work up and down. Fig. 39 shows the location of the cover and filler plug. Fill the housing to the level of the filler plug. The capacity is 11 pints (5.2 L).

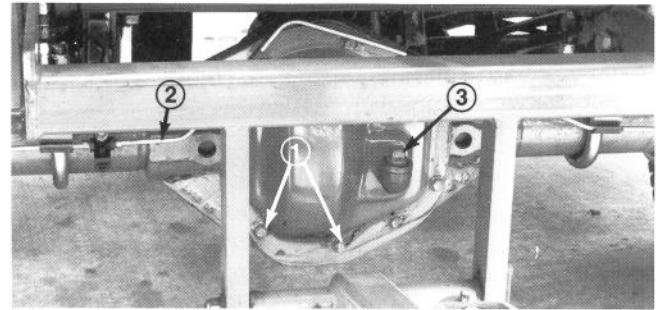

Figure 39

1. Cover bolts 3. Filler plug
2. Breather

GREASING FRONT WHEEL BEARINGS

Grease the front wheel bearings with #5 Wheel Bearing Grease every 1200 hours.

1. Set the parking brake and block the rear wheels.
2. Jack up one front wheel, support the axle with blocks and remove wheel from the hub. Remove the hub cap, cotter pin, slotted hex nut and flat washer.
3. Pull off the hub and outer bearing cone.
4. Thoroughly wash the old grease from the bearings, hub cap, spindle and hub with solvent.
5. Inspect the bearings and seal for signs of excessive wear. Replace them, if necessary. (Refer to Wheel Bearing Replacement, page 49).
6. Repack the bearings, lubricate the seal and reassemble the assembly to the spindle.
7. Mount the wheel to the hub to ease the adjustment of the bearings. Torque the wheel bolts to 40-60 ft-lb (54 - 81 N·m).
8. Tighten the slotted nut until the bearings bind slightly when rotating the wheel by hand. Back off the slotted nut to the nearest cotter pin hole and secure with a new cotter pin.
9. Reinstall the hub cap.
10. Use the same procedures for the opposite wheel.

HYDRAULIC SYSTEM AND FRAME LUBRICATION

HYDRAULIC OIL LEVEL

Check the oil level daily.

1. Run the engine for a period to warm the system oil. Raise the cutting units to the transport position.
2. Turn the engine off, open hood and prop it up with rod.
3. Free the dipstick with a 9/16 in. wrench and check oil level (Fig. 40).

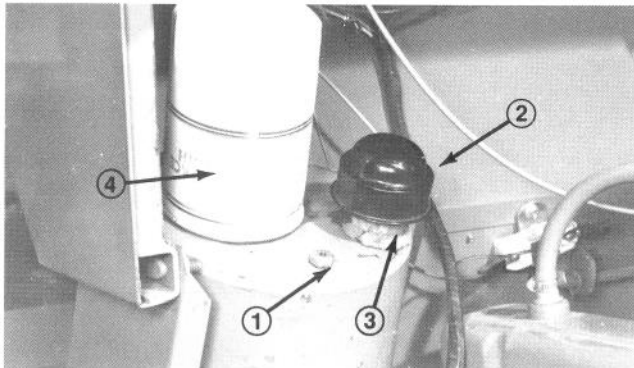

Figure 40

1. Dipstick
2. Breather cap
3. Cone shaped screen under cap
4. Filter

4. Replenish as necessary with SAE 10W-30 engine oil on Gasoline Tractors. Add Type "A", suffix "A", Automatic Transmission Fluid on Diesel Tractors. Remove breather cap to add oil. If screen in filler hole is contaminated remove and clean it in solvent before adding oil.

Note: Always be sure to clean the top of oil containers before puncturing them. Also clean all pour spouts, funnels, etc. used for adding oil to prevent contamination of system.

5. Re-install the dipstick.

BREATHING CAP AND FILTER

1. Remove and clean the breather cap by soaking it in solvent every 600 hours of operation. Dry the filter element in the cap with compressed air, then oil the element lightly with SAE 30 engine oil. Shake any excess oil out before reinstalling the cap.

2. Replace the hydraulic filter every 1200 operating hours. More frequently if operating under severe dirty conditions. Thoroughly clean the filter mounting surface on the reservoir and apply a film of clean oil to the filter gasket before mounting. Turn the filter on until the gasket contacts the reservoir, then turn 2/3 of a turn further.

HYDRAULIC OIL CHANGE

1. Drain and replace the hydraulic system oil every 3000 hours or sooner if the oil becomes contaminated. Flush the system, if contamination is evident, with No. 2 fuel oil; i.e. oil is milky or black in color or a major failure has occurred inside the pump or valve assembly.

2. Drain system by disconnecting the pressure hose at the rear of valve bank and placing it into a suitable drain pan. Start and run engine at idle to pump the fluid out of the system (Fig. 41).

IMPORTANT: Stop the engine immediately when fluid stops running to prevent damage to the pump.

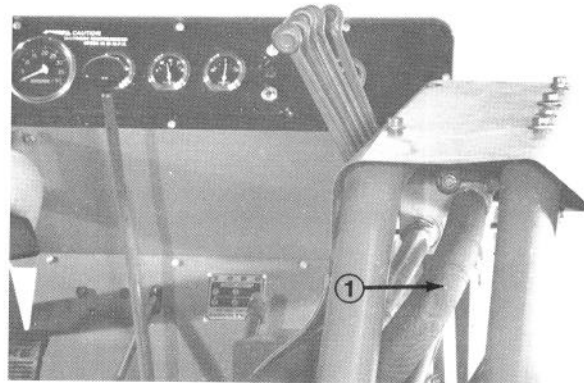

Figure 41

1. Remove pressure hose

3. Reconnect the pressure hose and add fresh clean SAE 10W-30 engine oil to the reservoir on Gasoline Tractors. Add Type "A", suffix "A", Automatic Transmission Fluid on Diesel Tractors. The reservoir capacity is 7 U.S. quarts (6.62 L).

4. Start the engine. Activate all hydraulic components to distribute the fluid.

5. Stop engine with mowers in full transport position and recheck oil level. Replenish as necessary.

GREASING AND OILING FRAME COMPONENTS

Apply Mobilux No. 2 grease to all hydraulic frame fittings and SAE 30 engine oil to all wear or friction points every 50 hours of operation. There are 22 grease fittings on the Parkmaster 7. Clean the grease fittings with a clean rag prior to greasing to make sure no foreign matter will be forced into the bearings with the lubricant. While applying grease, make certain the bearings are taking grease. Apply lubricant to the fitting until some of the grease comes out from the sides of the bearing.

Wipe the fittings and sides of the bearing clean after servicing.

HYDRAULIC SYSTEM AND FRAME LUBRICATION

Lightly oil wear or friction points whenever grease fittings are being serviced. The grease fittings and wear and friction points are indicated in the following pictures.

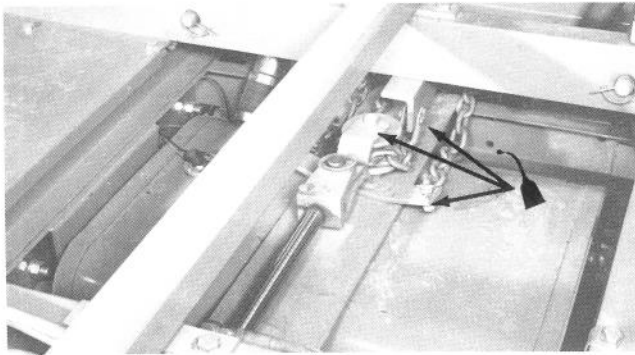

Figure 42
Center Frame

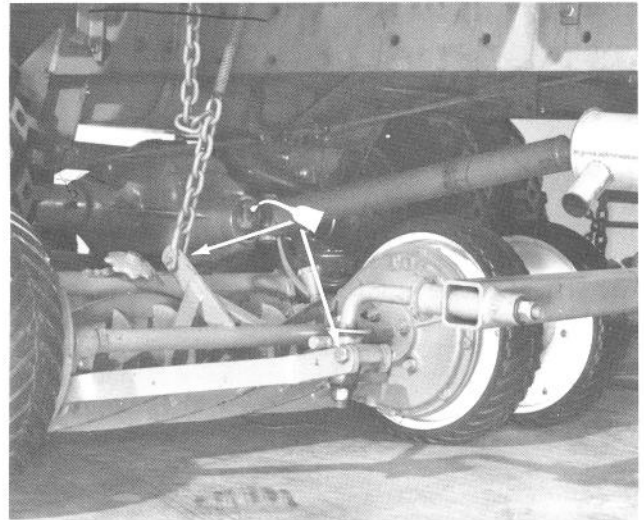

Figure 44
Number 2 & 3 Position

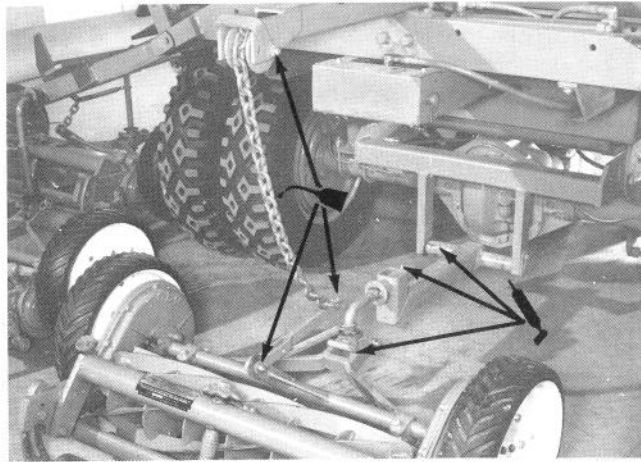

Figure 43
Number 1 Position

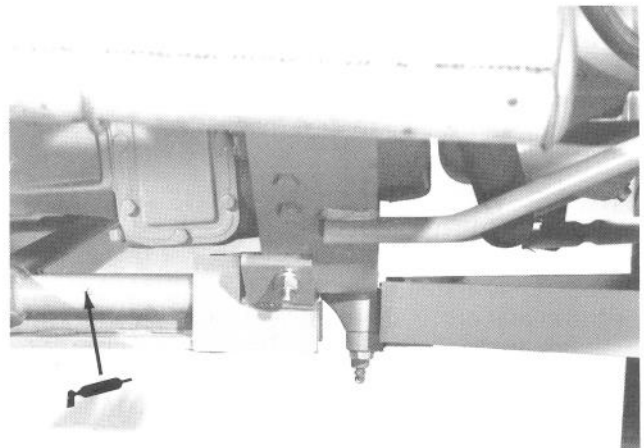

Figure 45

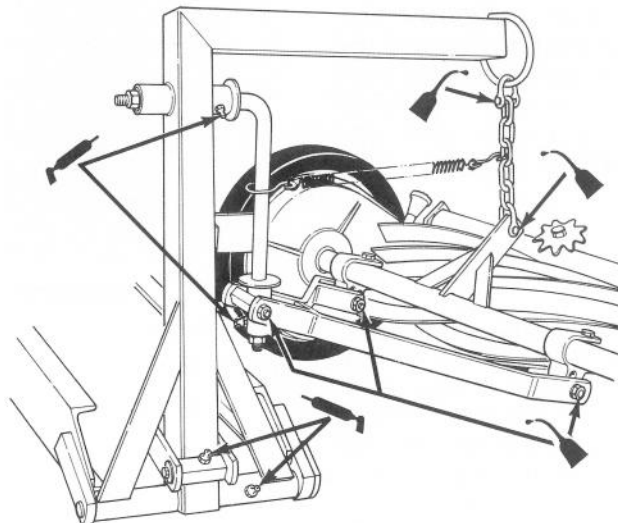

Figure 46
Number 4-7 Position

TRACTOR AND FRAME MAINTENANCE

ENGINE – MINOR MAINTENANCE AND ADJUSTMENT PROCEDURES (Gasoline)

Proper Maintenance and minor adjustment procedures are outlined in this manual. For more detailed specifications and maintenance procedures concerning "on the vehicle" adjustments that can be performed with the engine and transmission in the vehicle, refer to the General Motors Service Manual. For detailed instructions on major overhaul on your engine and transmission, refer to the General Motors Overhaul Manual. The Overhaul Manual contains "off the vehicle" overhaul of the major components. These procedures would generally be performed with the components on a bench.

Order these manuals from:

Helm Incorporated
Post Office Box 7706
Detroit, Michigan 48207

Order the Light Duty Truck Service Manual ST-330-76 and Light Duty Truck Overhaul Manual ST-333-74. A nominal charge will be requested by Helm Incorporated for each manual.

ENGINE – MINOR MAINTENANCE AND ADJUSTMENT PROCEDURES (Diesel)

Proper maintenance and minor adjustment procedures are outlined in this manual. A workshop manual is available from Perkins Engines, Inc. for detailed instructions on major repair. Use the following procedures to obtain the manual:

WORKSHOP MANUAL

A workshop manual covering your engine is available from Perkins Engines, Inc. at a reasonable fee. Write to the address shown at right on the card. Be sure to include the model and serial number from the machined pad on the exhaust manifold side of the engine. Please quote ALL the numbers and letters, and in the same sequence as stamped on the engine.

IMPORTANT NOTICE

A copy of Perkins Engines Advice of Engine Dispatch and Warranty Registration Card is shown. Please fill out each card and mail in as soon after receiving your new machine as possible. Perkins Engines will then be aware the engine has been put into service and will notify your local Perkins parts supplier. Please print "The Toro Company" after "Equipment or Boat Manufacturer" and note the name of your TORO distributor after "Purchased From" on the warranty card. Complete the rest of the card as requested.

ADVICE OF ENGINE DISPATCH		
MANUFACTURER		
ENG. NO. (PERKINS)	CHASSIS TYPE & NUMBER	
For P.E.I. use	Name and address of dealer	
PEI-38	DELIVERY DATE TO DEALER	

	
BUSINESS REPLY MAIL <small>FIRST CLASS PERMIT NO. 508, FARMINGTON, MICH.</small>	
PERKINS ENGINES, INC. P.O. BOX 697, 32500 VAN BORN RD. WAYNE, MICHIGAN 48184	
ATTENTION: SERVICE DEPARTMENT	

 WARRANTY INDUSTRIAL – AGRICULTURAL	
<p>1. DURATION OF WARRANTY Perkins Engines, Inc. (hereinafter called Perkins) warrants each new engine sold under the trademark "Perkins," and operated in the United States of America or Canada to power industrial or agricultural applications to the first retail purchaser thereof for a period of 12 months or 1,800 hours, whichever event shall first occur, to be free from defects in workmanship and material from the date of delivery to such purchaser.</p> <p>2. REPLACEMENT OF PARTS UNDER WARRANTY The responsibility of Perkins is limited to repairing or replacing, at its option, any part or parts of such engines that are returned to Perkins or any authorized Perkins distributor or dealer, with transportation charged prepaid, and which upon examination by Perkins shall disclose to Perkins's satisfaction to have been thus defective.</p> <p>3. PAYMENT OF REPAIR LABOR COST UNDER WARRANTY During the first 12 months or 1,800 hours of engine operation, whichever event shall occur first, from the date of delivery to the first purchaser, Perkins or any authorized Perkins distributor or dealer will cover the cost of reasonable labor required to repair any engine or replace any parts found by Perkins to be defective.</p> <p>4. Perkins's obligation under this Warranty shall not apply to: (a) Starters, Generators, Transmissions, Clutches, Radiators or any other proprietary fittings not manufactured by Perkins. These are warranted by their respective manufacturers, and not by Perkins. (b) Any engine which shall have been subject to negligence, misuse,</p>	<p>accident, misapplication or overspeeding. (c) Any engine that has been repaired or altered by anyone in a manner which in Perkins's sole judgment adversely affects its performance or reliability. (d) Any engine which has been fitted with or repaired with parts or components not manufactured or approved by Perkins which in Perkins's sole judgment adversely affects its performance or reliability. (e) Engine tune-ups, normal maintenance services including but not limited to valve adjustment, normal replacement of service items, fuel and lubricating oil filters, lubricating oil, fan belts, antifreeze, etc. (f) Damages caused by prolonged or improper storage of the engine after shipment from a Perkins factory. (g) Loss of operating time to the user while the engine or engine driven equipment is out of operation and damage to equipment powered by the engine.</p> <p>5. This warranty and the obligation of Perkins Engines, Inc. thereunder is in lieu of all other warranties, express or implied, including without limitations, the implied warranties of merchantability and fitness for particular purpose, all other representations to the purchaser and all other obligations or liabilities including liability for incidental and consequential damages on the part of the manufacturer.</p> <p style="text-align: center;">SPECIAL NOTE</p> <p>Perkins engines are marketed throughout the world to many manufacturers of original equipment. In order to meet the special requirements of these engines may on occasion be covered by specific warranties applicable to the requirements of the driven equipment. In these instances the warranty extended by Perkins to said manufacturer supersedes the above warranty.</p>
WARRANTY REGISTRATION CARD	
In order to help us provide complete service for our product, would you complete this card and return it.	
Print Name _____	
Address _____	
City _____	State _____ Zip _____
Equipment or Boat Manufacturer _____	
Engine Serial Number _____	
Date of Purchase _____	
Purchased From _____	NA4555

TRACTOR AND FRAME MAINTENANCE

AIR CLEANER (Gasoline)

Remove and clean the element by shaking it every 150 hours of operation or more often if the tractor is subjected to extremely dusty conditions. (DO NOT TAP THE ELEMENT AGAINST A SOLID OBJECT IN AN ATTEMPT TO CLEAN IT. DO NOT WASH THE ELEMENT. IF THERE ARE ANY VISIBLE SIGNS OF DAMAGE TO THE ELEMENT, REPLACE IT.)

IMPORTANT: For maximum protection, use only a replacement filter available from your TORO Distributor.

Note: Assure air cleaner assembly is securely clamped to engine carburetor.

AIR CLEANER (Diesel) (Fig. 47).

A diesel engine takes in a full charge of air on each intake stroke — there is no carburetor to throttle the air. This engine will use approximately 10,000 cubic feet (283 m³) of air each hour of operation. With this large volume of air entering the engine, it is extremely important to service the air cleaner regularly, as follows:

1. In normal conditions, remove the element every 100 hours of operation and shake out the accumulated dust. In extremely dusty conditions, service daily, or several times a day.
2. DO NOT WASH THE ELEMENT.
3. Install a new element every 400 hours of normal operation, or more often if the unit has been subjected to extreme dust conditions.

IMPORTANT: When removing the element, use care to avoid dropping dirt down into the intake manifold. Periodically check to make certain the gasket in air cleaner base is seated against intake manifold port and air cleaner assembly is securely clamped.



Figure 47
1. Air cleaner

COOLING SYSTEM

The capacity of the cooling system is 13 U.S. quarts (12.3 L) for gasoline engine tractors. 16 quarts (15.14 L) for diesel engine tractors. The tractor is shipped from the factory with a 50-50 solution of water and ethylene glycol antifreeze in the system. Do not use alcohol or methanol base coolants or plain water.

IMPORTANT: Even though there is no anticipated danger of freezing, it is recommended that the cooling system be protected with an ethylene glycol anti-freeze coolant to at least 0° F (-18° C). This is necessary for corrosion protection, proper temperature gauge operation, and proper coolant boil protection.

Drain and flush the system once every two years. The radiator drain cock is located at the lower right corner of the radiator. The block drain cock for the Chevrolet engine is shown in Figure 48. The diesel block drain in Figure 49. Periodically use an air hose and clean radiator fins and grille screen to make sure of maximum cooling efficiency.

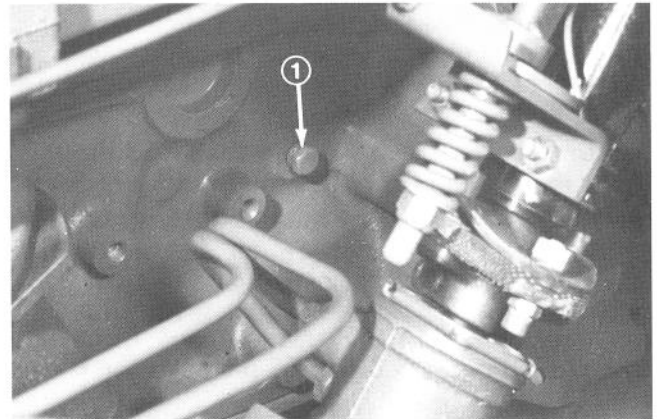

Figure 48
1. Block drain

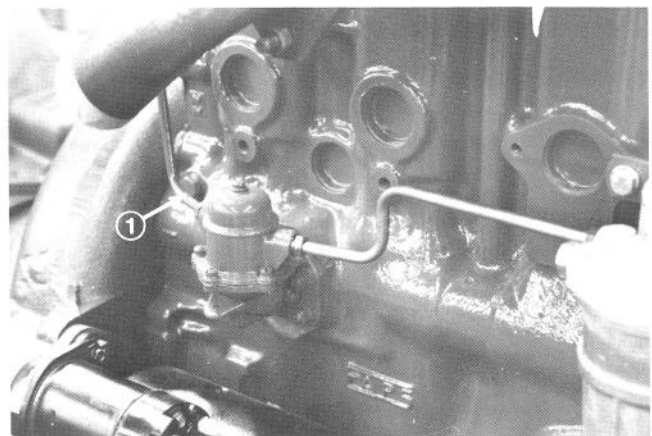

Figure 49
1. Diesel block drain

TRACTOR AND FRAME MAINTENANCE

A 195° (91°C) thermostat — Gasoline, 180° (82°C) thermostat — Diesel, and a 15 PSI (103.4 kPa) radiator pressure cap are standard equipment. It is extremely important that there be no leaks in the system.

The coolant level should be kept approximately 1 inch (25 mm) below the bottom of the radiator filler hole.

SPARK PLUGS (Gasoline)



CAUTION

Do not remove spark plug wires while engine is running. The secondary voltage can jump an arc and cause an electrical shock.

Before removing spark plugs, clean all foreign material from around the parts with compressed air. Since silicone insulated spark plug wire boots seal tightly on spark plugs, twist the boot about 1/2 turn in either direction to break the seal. Then remove the wires and loosen each plug one turn. Reconnect the wires and start the engine. Accelerate to approximately 1000 RPM to blow away any dirt or carbon particles. Stop engine, disconnect wires, and remove plugs.

Gap new or serviced plugs to .033-.038 in. (0.84-0.97 mm). Bend only the ground, or outside electrode. Torque the spark plugs to 15 ft-lb (20 N·m).

IMPORTANT: Do not over-tighten. These spark plugs do not require a sealing washer. If the plugs are over-tightened, they may be very difficult to remove. Use only AC R46TS plugs, or the equivalent.

Figure 50 shows the cylinder numbering and plug wire locations.

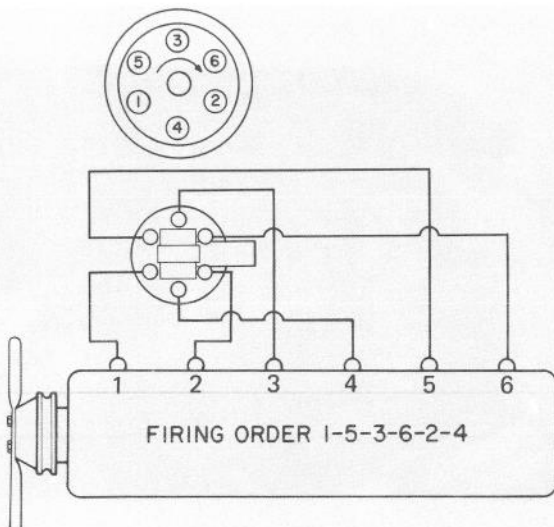

Figure 50

CARBURETOR (Gasoline)

With the accelerator pedal fully depressed, the carburetor throttle butterfly should be fully open. If it is not, refer to Figure 51 and proceed as follows.

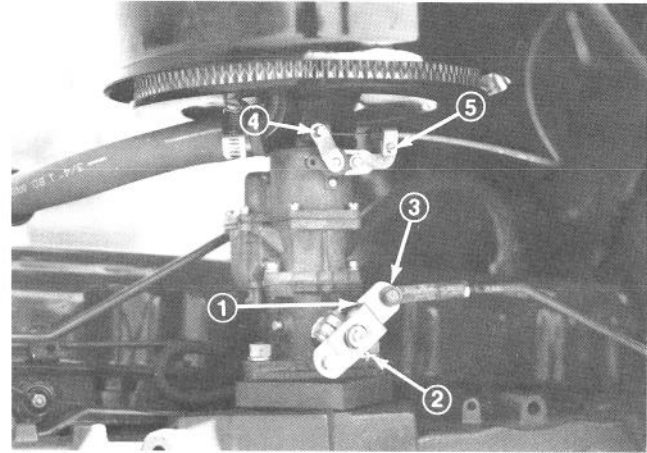

Figure 51

- | | |
|--------------------------|--------------|
| 1. Arm | 4. Set screw |
| 2. Idle speed stop screw | 5. Clamp |
| 3. Idle mixture screw | |

1. Loosen the capscrew holding the inside clamp to the shaft.

2. Turn the butterfly shaft until the butterfly is fully open and hold the accelerator pedal to the floor.

3. Rotate the clamp on the butterfly shaft until the clamp contacts the arm.

4. Tighten the clamp in this position.

Note: It is possible for the arm to go over-center in the idling position. Adjust the link if necessary to locate the arm as shown in Figure 51.

5. Attach one lead (+) from a tachometer to the tachometer terminal on the distributor, the other lead (-) to a good ground on the engine. (See Wiring Schematic, page 54).

6. Start the engine and run it until it is thoroughly warm.

Adjust the idle speed stop screw until the engine idles at 400 RPM.

Adjust the idle mixture screw until the engine runs smoothly at idle speed.

Note: An optional adjustable high speed jet assembly is available. Refer to the carburetor parts listing in your parts catalog. Order the assembly from your TORO Distributor. The adjustable high speed jet provides proper air/fuel mixture for high altitude operation.

TRACTOR AND FRAME MAINTENANCE

CHOKE WIRE ADJUSTMENT (Gasoline) (Fig. 51)

If the choke wire is disconnected, it must be adjusted so the choke butterfly is fully open with the choke button fully in, and fully closed with the choke button out. Secure the choke wire in the butterfly arm with the setscrew so the arm has full travel to meet the above conditions. Secure the cable with the clamp.

GOVERNOR, OPTIONAL (Gasoline)

If the governor or linkages have been removed or disturbed, adjust as follows:

1. Make certain the carburetor is properly adjusted.
2. Adjust the low speed stop screw so 1/8 inch (3 mm) protrudes through the bracket as shown in Figure 52. Secure with the jam nut.

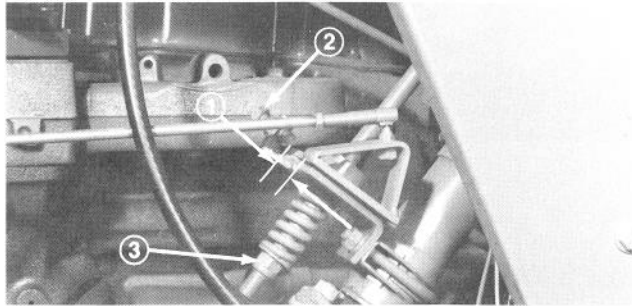

Figure 52

1. 1/8 in. (3 mm)
2. Jam nut
3. Lever tension adjustment

3. With the engine shut off, move the throttle lever to full speed position (all the way back). Loosen the jam nuts and adjust the control rod length to provide 1/32 inch (0.79 mm) clearance between the carburetor bell crank and the stop pin on the carburetor (Fig. 53).

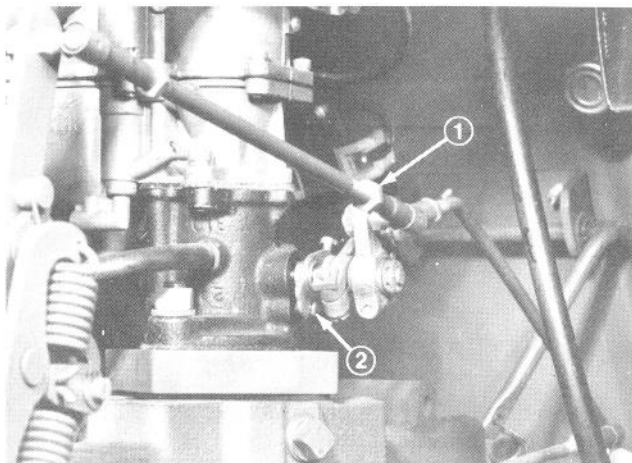

Figure 53

1. Adjust this rod
2. 1/32 in. (0.79 mm) clearance

4. Connect a tachometer to the terminal on distributor and a good ground on the engine. (Refer to carburetor section on page 34).

Start the engine and allow it to warm up to normal operating temperature. Check carburetor and adjust screw to get smooth engine operation. Move hand throttle lever to provide an engine speed of 1600 RPM.

5. To stabilize the governor, eliminate hunting, or to increase the spread of RPM between no-load and full load, loosen the locknut on the regulation screw (Fig. 54), turn the screw counterclockwise 1/8 turn, and tighten the locknut. Readjust hand throttle lever to obtain 1600 RPM. Repeat this procedure as required for proper engine operation.

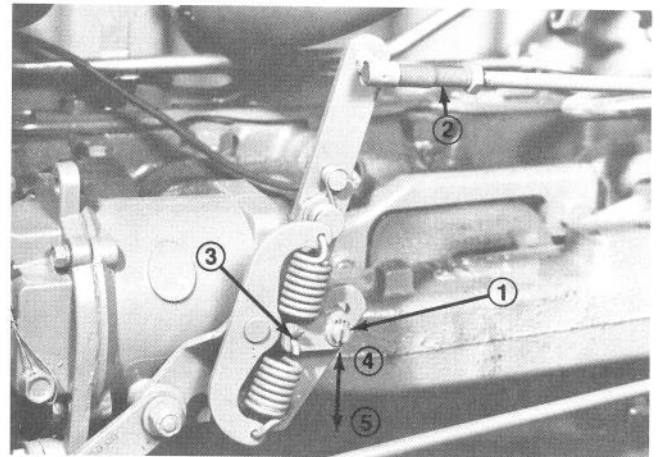

Figure 54

1. Regulation screw and locknut
2. Control rod
3. 0.060 in. (1.52 mm) gap
4. Move up to decrease regulation
5. Move down to increase regulation

6. Loosen the jam nuts and adjust the length of the governor control rod to provide a .060 in. (1.52 mm) gap between the governor link and arm when engine idle speed is set at 400 RPM. (Adjust low speed idle screw on the carburetor if necessary to obtain 400 RPM idle speed.)

7. Tighten all jam and locknuts and check to see that all control linkage operates freely without binding.

Note: The foot accelerator will over-ride the hand throttle setting if the tractor is operating at less than maximum ground speed. Machine will return to original hand throttle setting when pedal is released.

8. If the throttle lever "creeps" at high speeds, tighten the lever tension nut (Fig. 52) to apply additional tension to the lever.

TRACTOR AND FRAME MAINTENANCE

ENGINE TIMING (Gasoline)

IMPORTANT: Before attempting to adjust ignition timing, make sure carburetor is properly adjusted. Disconnect vacuum line from distributor vacuum advance unit and plug open end of the line.

The timing tab is shown in Figure 55. Clean the tab and pulley so they will be easily visible as the timing light flashes. Markings on the tab are in 2-degree increments, with the "O" mark being top dead center.

This engine is timed at 10° before top dead center with the engine idling about 550 RPM. (Refer to Carburetor section, page 34 for proper tachometer connection.) Timing is set on No. 1 cylinder.

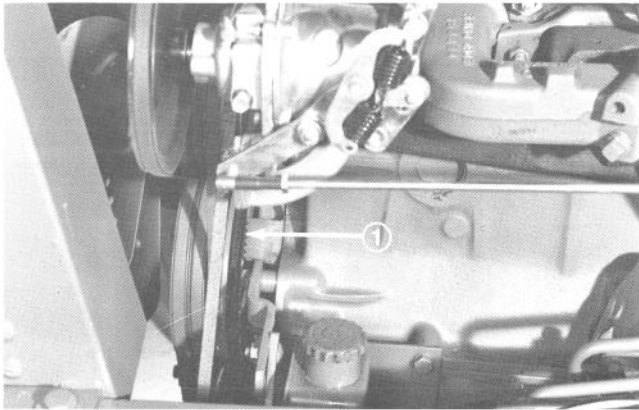

Figure 55

1. 10 degrees BTDC (before top dead center)

Make timing light connections in parallel, using an adapter at distributor number one terminal. With timing light connected to No. 1 spark plug, and with engine idling, loosen the mounting clamp screw at the base of the distributor and rotate the distributor as necessary to synchronize flashes with timing mark when mark is aligned with notch in pulley. After completing adjustment, tighten capscrew and connect vacuum line.

FUEL FILTERS (Gasoline)

Your tractor is equipped with two filters in the fuel system; one in the inlet side of the carburetor and one in the fuel line (Fig. 56 & 57).

The filter screen in the carburetor should be cleaned every 1200 hours of normal operation, or whenever the engine seems to be starving for fuel. Remove the cap, gasket and screen, and blow clean with compressed air from the inside out.

Replace the in-line filter each time the carburetor filter is serviced. The arrow on filter should point towards the carburetor.

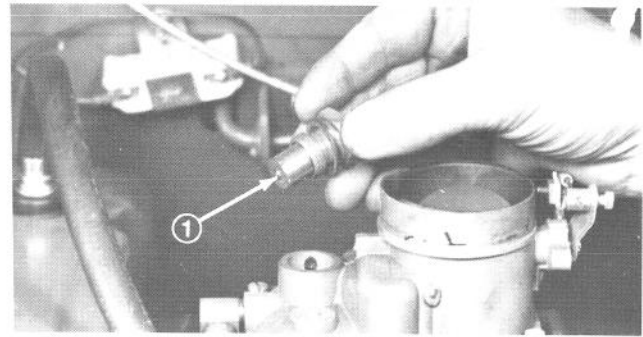

Figure 56

1. Filter

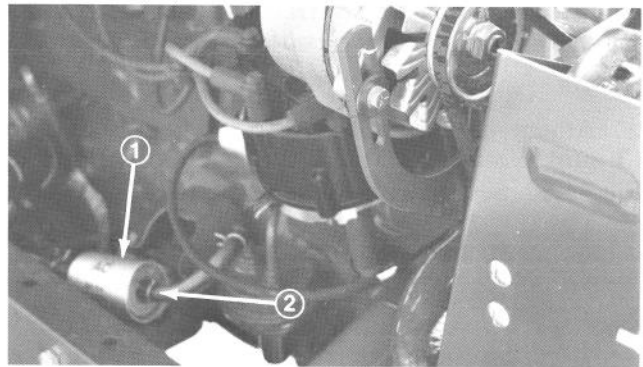

Figure 57

1. In-line filter
2. Arrow in direction of flow

FUEL TANK

If the felt strips under the fuel tank straps have deteriorated to the point that there is metal-to-metal contact, install new felt strips to prevent a possible leak and/or a fire hazard (Fig. 58).

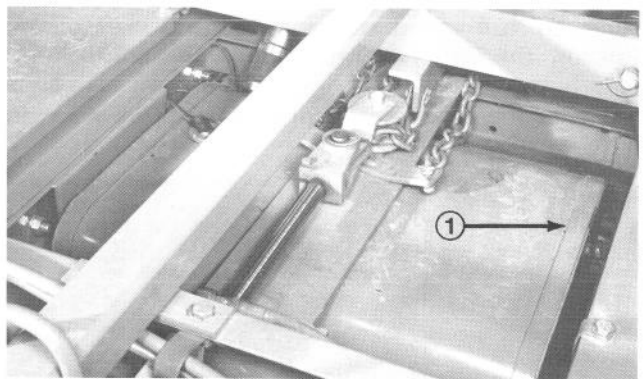

Figure 58

1. Felt strips

FUEL FILTER (Diesel) (Fig. 59)

Change the fuel filter element every 400 hours of normal operation, or more often if the tractor is subjected to extremely dusty conditions. If an unexplained loss of power is experienced, change the element immediately.

TRACTOR AND FRAME MAINTENANCE

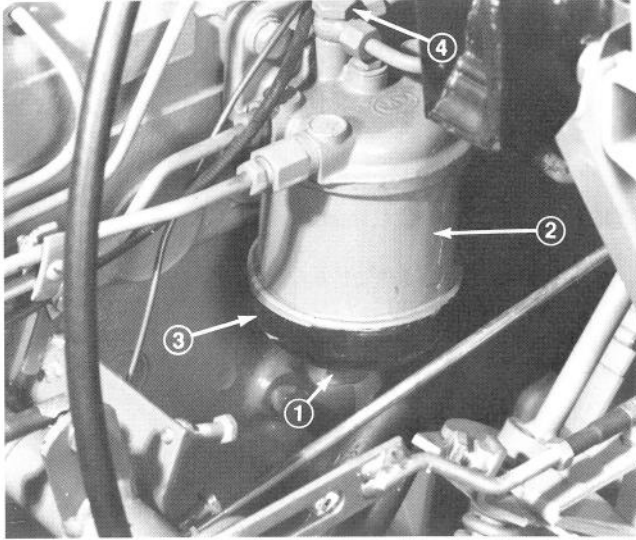

Figure 59

- | | |
|--------------------------------|---------------|
| 1. Knurled nut and thumb screw | 3. Bowl |
| 2. Element | 4. Vent screw |

1. Thoroughly clean the outside of the fuel filter assembly.
 2. Loosen the knurled nut and thumb screw and remove the bowl and element from the filter head.
 3. Discard the element and the fuel in the bowl.
 4. Clean the bowl in cleaning fluid. **DO NOT USE GASOLINE TO CLEAN THE BOWL.**
 5. Hold the bowl and new element in position, tighten thumb screw, and secure with knurled nut. If the element and bowl are positioned properly, finger tightening is enough to provide a good seal.
 6. After the filter is assembled, the air must be purged from the system. Loosen the vent plug on the filter head two or three turns.
 7. Operate the priming lever on the fuel lift pump until pure fuel, free from bubbles, comes out around the vent screw (Fig. 61). Tighten the vent screw.
- Note:** If the priming lever cannot be moved fully, it means that the camshaft lobe is up. The engine must be turned over one revolution so the lobe is down, and the pump can be operated (Fig. 61).
8. Loosen the union at the injection pump inlet (Fig. 73). Operate the priming lever until pure fuel, with no bubbles, is being forced out around the threads. Tighten the union.
 9. Wipe off the fuel forced out around the pump inlet and the filter vent screw.
 10. The engine is now ready for starting.

FUEL WATER TRAP (Diesel) (Fig. 60)

The fuel water trap is installed between the tank and the fuel pump. Water, being heavier than the fuel, collects at the bottom of the trap. **THE WATER MUST BE DRAINED OUT REGULARLY, BEFORE IT CAN REACH THE PUMP AND INJECTORS.**

Every 40 hours of operation, loosen the thumb screw (Fig. 60), allow the collected water to drain out, and re-tighten the thumb screw. We suggest filling the fuel tank at the end of the day's operation, to prevent condensation in the tank overnight.

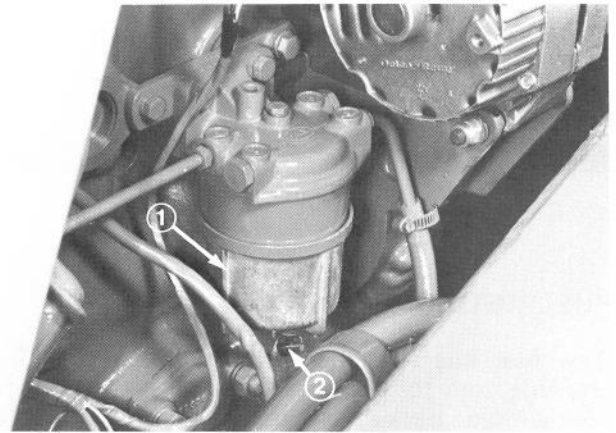

Figure 60

- | | |
|---------------|----------------|
| 1. Water trap | 2. Thumb screw |
|---------------|----------------|

Note: If the engine is being operated in an area of high humidity, it may be necessary to drain the water trap daily. When the engine is new, we suggest draining the trap frequently into a glass container about the size of the fuel trap. You can see how much water is collected, and can determine the proper interval for draining for your area. See Fuel Requirements (Diesel), page 22, for correct fuel recommendations.

FUEL LIFT PUMP (Diesel) (Fig. 61)

The lift pump is camshaft-operated to pump fuel from the tank to the filter and the injection pump. It is also used to manually prime the filter and pump after running out of fuel, changing the filter element, or any time the fuel lines are disturbed. Pump the lever up and down to operate the pump (Fig. 61). If the lever cannot be moved fully, apparently the camshaft lobe is up, and the engine must be turned over one complete revolution to get the cam lobe down so the lever can be operated.

Every 1200 hours, or once a year (whichever comes first), remove the pump cover and diaphragm. Clean

TRACTOR AND FRAME MAINTENANCE

the sediment chamber and check the diaphragm. If the diaphragm has holes, cracks, or is brittle, discard it and install a new one. When reassembling, tighten the cover screw just enough to make a tight sealing joint. **DO NOT OVER TIGHTEN.** Prime the fuel system.

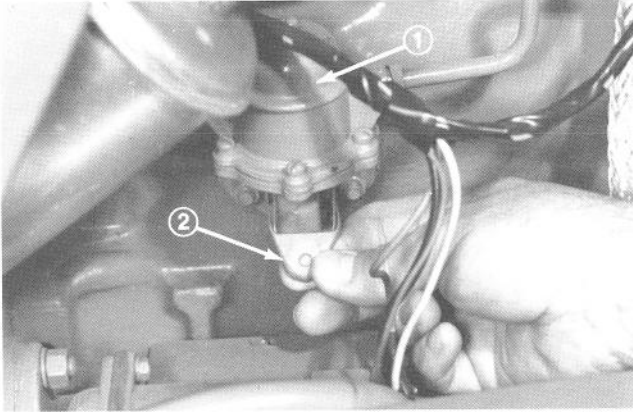

Figure 61

1. Fuel lift pump 2. Priming lever

FUEL RETURN LINE (Diesel)

The fuel line (Fig. 62) returns unused fuel from the injectors to the tank. A small amount of fuel is metered back past the injector nozzles for lubricating purposes. This fuel must be evacuated to prevent a hydraulic lock and faulty nozzle operation. Be sure the return line is not pinched or crimped shut.

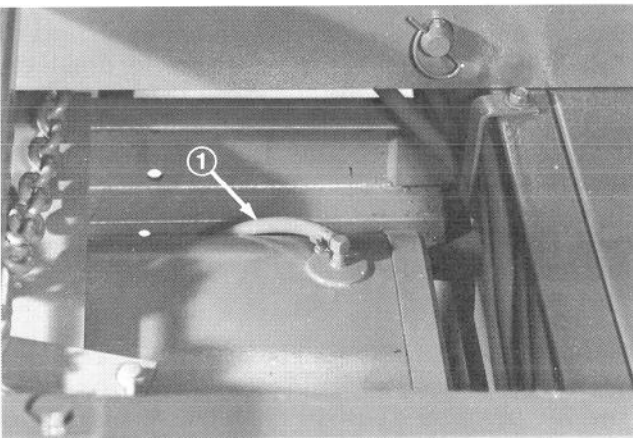

Figure 62

1. Fuel return line

FUEL INJECTION PUMP (Diesel) (Fig. 73)

The injection pump is operated by the engine camshaft. The pump is lubricated by the fuel it pumps. The release pressure in the injectors is approximately 2500 PSI (17 238 kPa). All adjustments on the pump except the idle speed stop screw are sealed. **IF THE SEALS ARE BROKEN OR DISTURBED, THE ENGINE WARRANTY IS VOIDED.**

If you encounter any problems with the fuel system, check all other components (filter, lift pump, injectors, etc.) before removing the injection pump. The pump itself is relatively trouble-free if the fuel is kept clean.

FUEL INJECTORS (Diesel)

The injectors are set at a 2500 PSI (17 238 kPa) minimum operating pressure. The symptoms of injector troubles are usually one or more of the following:

1. Misfiring.
2. Knocking in one or more cylinders.
3. Loss of power.
4. Smoky exhaust (black).
5. Increased fuel consumption.

The faulty injector can be isolated by disconnecting the fuel line to each injector in turn, with the engine running at a fast idle. The disconnected injector which LEAST affects engine operation and speed is the defective one. Remove the defective injector and cap the fuel line.

IMPORTANT: Do not attempt to repair or adjust an injector without the proper equipment. It is impossible to adjust an injector properly, and it could be dangerous, since the working pressure is sufficient to cause the fuel oil to penetrate the skin. Take the injector to your TORO distributor or to a Perkins distributor.

When reinstalling the new or serviced injector, clean the carbon out of the recess in the cylinder head, use a new copper washer, and torque the injector nuts evenly and gradually to 12 ft-lb 16 N·m). Be sure to tighten the nuts alternately, a little at a time, to avoid cocking the injector, which could bind the nozzle or misdirect the spray.

DRAINING FUEL TANK

A standpipe is provided at the fuel tank outlet fitting which allows contaminants to settle to the bottom of the tank without being drawn into the engine. Periodically remove the drain port at the bottom of the fuel tank and allow the foreign material to drain out of the tank.

POSITIVE CRANKCASE VENTILATION (PCV) VALVE (Gasoline) (Fig. 63)

The positive crankcase ventilation valve (Fig. 63) returns blow-by gases from inside the valve cover to the combustion chamber where they are burned. If this valve becomes plugged or partially plugged, the increased pressure in the engine

TRACTOR AND FRAME MAINTENANCE

could cause rough idling, erratic running or surging, oil leaks and seal damage. If any of these conditions exist, check the PCV valve before attempting any more serious overhaul procedures.

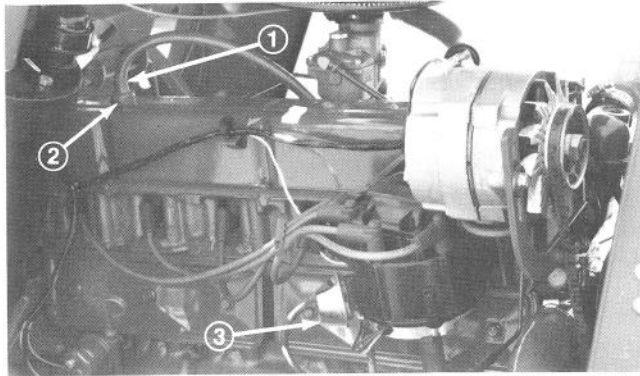

Figure 63

1. PCV valve
2. Large end must be installed in grommet
3. Engine serial number

Inspect this valve for proper operation at the time of the first oil change, and at each subsequent oil change. To inspect the valve, proceed as follows:

1. Connect a tachometer to the engine. (See Carburetor section, page 34).
2. Start the engine and make certain the idle mixture and idle speed are correct.
3. Remove the valve (with hose attached) from the valve cover.
4. Plug the inlet to the valve and note the change in engine RPM.
5. If plugging the valve causes a change of less than 50 RPM with the engine idling, a clogged, or partially restricted valve is indicated.
6. If necessary, remove the plugged valve and install a new one. The large end of the valve goes into the grommet on the valve cover.

IMPORTANT: Install valve correctly for proper air flow. Do not reverse. Change the PCV valve every 500 hours of operation.

FLAME ARRESTER (Gasoline) (Fig. 64)

The hose leading from the air cleaner to the valve cover provides a clean airflow through the engine. The flame arrester at the lower end of the hose prevents a possible fire in the engine in the event of a back fire through the carburetor. Clean the flame arrester in solvent every 1000 hours of operation (Fig. 64).

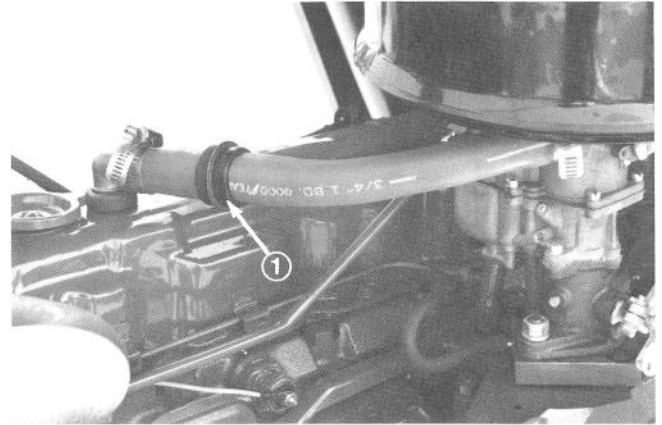

Figure 64

1. Flame arrester

BATTERY

The electrical system has a negative ground.

Keep the liquid level in the battery about 3/8 inch (10 mm) over the top of the plates. The specific gravity of the battery should be 1.250. Distilled water should be used to eliminate the possibility of harmful impurities being added to the electrolyte. Check each cell. If the tractor is to be used during extremely cold weather, it is important that the battery has a full, or nearly full charge. A fully charged battery can withstand a much lower temperature (Fig. 65).

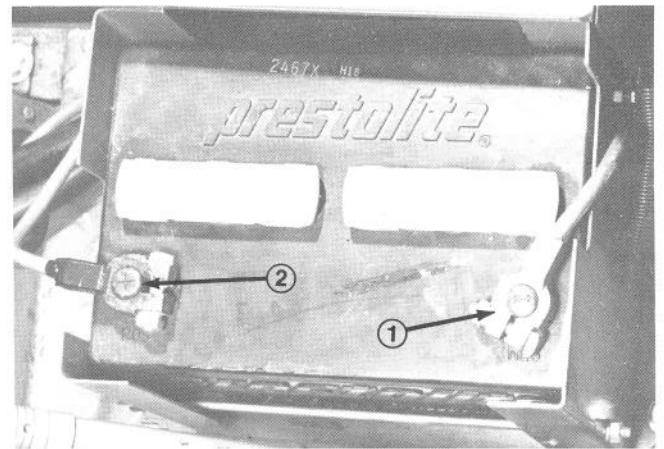

Figure 65

1. Negative (to ground)
2. Positive (to solenoid)



CAUTION

Disconnect battery ground cable when charging battery to prevent accidentally reverse polarizing the charging system and causing damage to the system.

TRACTOR AND FRAME MAINTENANCE

In freezing weather, run the engine for 15 to 20 minutes after adding battery water to prevent freezing.



WARNING

Since normal battery chemical action generates hydrogen gas which is explosive when mixed with air, never expose the battery to an open flame or electrical spark. Also, avoid getting battery fluid, which is a sulfuric acid solution, on skin, on clothing or other fabrics, or on painted surfaces. Eye protection should be worn while working on the battery.

Hydrogen gas may be released by a battery and is generally present when the battery has been, or is charging. If a booster battery is being used, and the booster battery is part of another vehicle's electrical system, the booster battery should be treated carefully when using jumper cables — follow exactly the procedure outlined below, being careful not to cause sparks which could ignite any hydrogen which might be present when attaching jumper cable clamps to the two batteries.

The battery cable terminals must be clean and tight. When corrosion appears on the terminals they should be cleaned in a solution of baking soda and water or ammonia and water. After cleaning, the top of the battery should be flushed off with clean water.

The connections in the entire charging system must be kept tight and free from corrosion or anything that will cause high resistance in the circuit.



CAUTION

Never remove alternator "bat" lead without first disconnecting battery ground cable. Do not short across or attempt to polarize system.

JUMP STARTING WITH AUXILIARY (BOOSTER) BATTERY

If booster battery is part of another vehicle's electrical system, booster should be treated carefully when using jumper cables. Follow exactly the procedure outlined below, being careful not to cause sparks which could ignite any hydrogen gasses present:

1. Set parking brake and place transmission in "NEUTRAL".
2. Attach one end of one jumper cable to the positive terminal of the booster battery (identified by "+" or "P" on the battery case, post or clamp) and the other end of same cable to positive terminal of discharged battery.
3. Attach one end of the remaining cable to negative terminal ("—" or "N") of "good" battery, and finally to the engine block of the stalled vehicle, NOT TO THE NEGATIVE TERMINAL OF THE BATTERY ITSELF.

Reverse this sequence exactly when removing the jumper cables.



CAUTION

Any procedure other than the above could result in personal injury caused by electrolyte squirting out the battery vents, damage or injury due to battery explosion, and/or damage to the charging system of the booster vehicle's or immobilized vehicle's charging system. Do not attempt to jump start a vehicle having a frozen battery because the battery may explode. If a frozen battery is suspected, open and examine all fill vents on the battery. If ice can be seen, or the electrolyte fluid cannot be seen, do not attempt to start with jumper cables.

MANIFOLD HEAT CONTROL VALVE (Gasoline)

Check the manifold heat control valve occasionally to make certain it is operative with the anti-rattle spring and thermostatic spring in place. If the shaft is frozen, free it up with graphite in alcohol. When engine is cold, the spring should cause valve to move to closed position (Fig. 66).

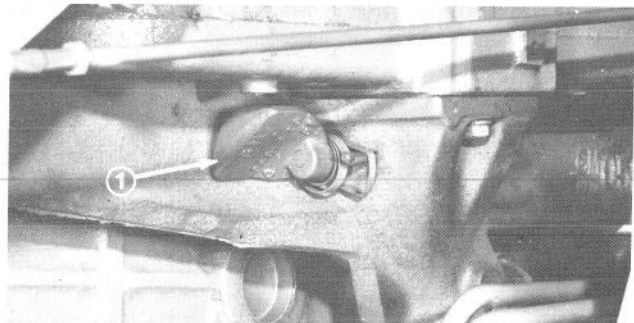

Figure 66

1. Manifold heat control valve

TRACTOR AND FRAME MAINTENANCE

ENGINE MOUNTS

The engine is attached to the frame with four rubber mounts. If any of the mounts deteriorate, we recommend replacing all four to maintain proper engine alignment. Block the engine up securely and replace the mounts one at a time (Fig. 67).

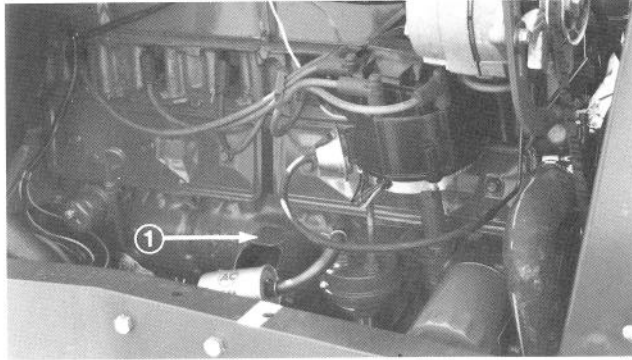

Figure 67

1. Front engine mount

FAN BELTS (Gasoline)

The fan is driven from the crankshaft pulley by both the power steering belt and the alternator belt. Thus, it is essential that both these belts be tensioned properly. If one belt slips, the other will wear prematurely and soon start to slip. See the following instructions for tensioning the power steering and alternator belts.

POWER STEERING BELT (Gasoline)

The power steering pump belt must be properly tensioned to assure an adequate flow of fluid throughout the power steering circuit, and to drive the fan at the proper speed. Keep the belt adjusted to a 6-7 pound (2.7 - 3.2 kg) pull with a spring scale. Place the scale midway in the longest span and tension until a deflection of 11/64 inch (4.4 mm) is achieved. Loosen the pump mounting bolts, pry upward to tighten the belt and tighten the bolts (Fig. 68).

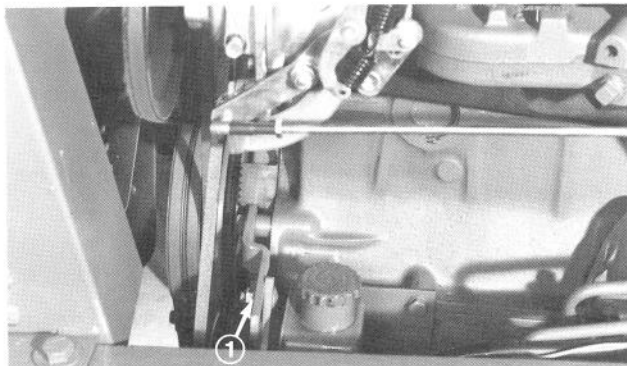

Figure 68

1. Loosen to adjust belt

ALTERNATOR BELT (Gasoline)

Check the tension of the alternator belt frequently. A loose belt will slip, thus reducing the speed of the alternator and fan. A belt that is too tight will impose an unnecessary load on the fan and alternator bearings. The belt tension is correct when a force (pull) of 4-5 pounds (1.8 - 2.3 kg) midway in the longest span will produce a deflection of 1/4 inch (6 mm). Loosen the nuts shown in Figure 69 and rotate the alternator to the position necessary to attain the proper tension.

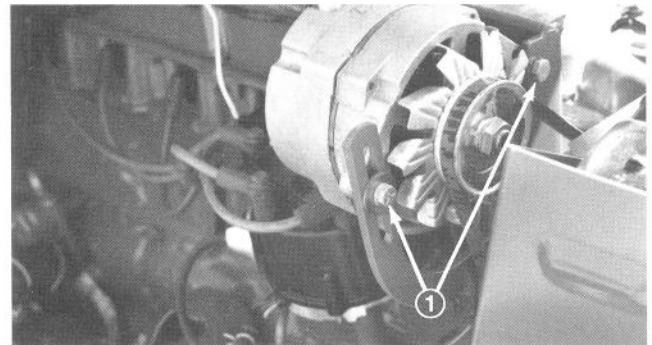

Figure 69

1. Loosen to adjust belt

FAN AND ALTERNATOR BELT (Diesel)

The fan and alternator belt must be kept tight enough to drive the fan, water pump and alternator at their proper speeds, but not so tight as to impose an unnecessary load on the bearings.

To adjust, loosen the pivot bolt and the capscrew through the adjusting strap. Pull the alternator outward to tighten the belt. Adjust until the belt deflects about 3/8 in. (10 mm) midway between the alternator and crankshaft pulleys, with a force of approximately 10 pounds (4.5 kg) applied (Fig. 70).

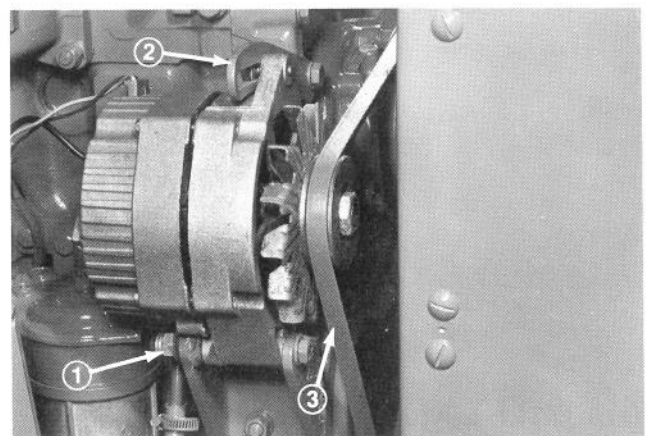

Figure 70

1. Loosen to adjust
2. Adjust strap
3. 3/8 in. (10 mm) deflection at mid-span

TRACTOR AND FRAME MAINTENANCE

GOVERNOR BELT (WITH OPTIONAL GOVERNOR) (Gasoline)

Keep the governor belt adjusted so a force of 8-9 pounds (3.6 - 4.1 kg) applied to a new belt, or 6-7 pounds (2.7 - 3.2 kg) on a used belt, when applied to the center of the belt span, will produce a deflection of 1/8 inch (3 mm). To adjust the belt, loosen the two mounting bolts and pry up on the governor casting (Fig. 71).

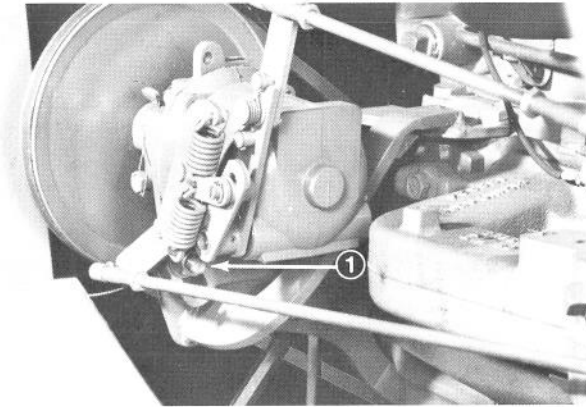

Figure 71

1. Loosen to adjust belt

HYDRAULIC PUMP BELTS, MATCHED SET (Gasoline)

The hydraulic pump is driven by a matched set of two belts. Keep them adjusted evenly so a force of 6-7 pounds (2.7 - 3.2 kg) midway in the span will result in a deflection of 1/8 inch (3 mm). To adjust loosen the mounting bolts, pry the pump to the left (when facing the pulley from the front), and tighten the bolts. When replacing, the belts must be replaced as a matched set (Fig. 72).

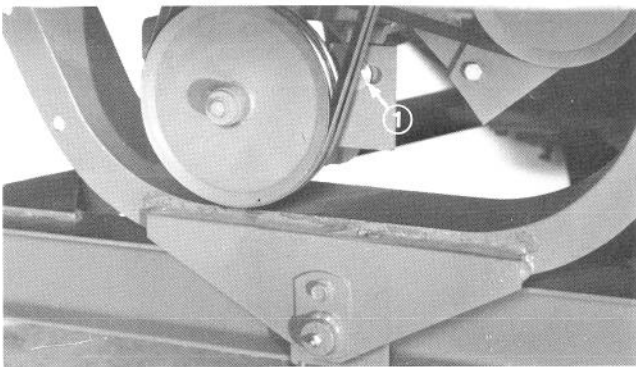

Figure 72

1. Loosen to adjust belts

THROTTLE LINKAGE (Diesel)

The throttle lever has sufficient leverage available to damage the internal parts of the injection pump if the lever is FORCED in either direction. For this

reason, stops are provided on the linkage to limit movement before damage occurs. Figure 73 shows the idle stop and the high speed stop on the injection pump. The idle stop can be adjusted; the high speed stop is sealed. IF THIS SEAL IS BROKEN, THE ENGINE WARRANTY IS VOIDED.

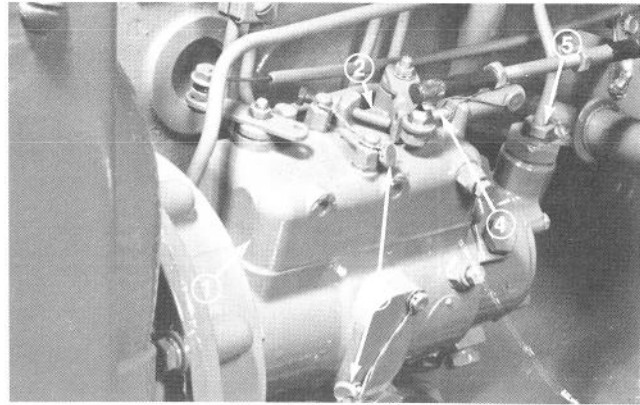

Figure 73

1. Fuel injection pump
2. Idle speed stop screw (adjustable)
3. Seals
4. High speed stop screw (sealed-not adjustable)
5. Pump inlet

HIGH SPEED STOP (Diesel)

Place the throttle lever in the wide open position. Adjust the upper stop bolt to contact the bell crank when there is approximately .030 in. (0.76 mm) clearance between the arm on the pump and the sealed high speed stop screw. THE BELL CRANK MUST CONTACT THE STOP BOLT TO PREVENT THE PUMP ARM FROM CONTACTING THE SEALED STOP SCREW (Fig. 74).

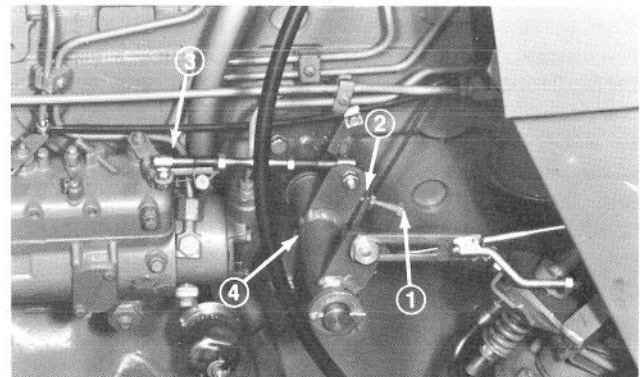

Figure 74

1. Linkage stop bolt (High speed)
2. Adjust for contact here
3. 0.030 in. (0.76 mm) clearance between screw and pump arm
4. Bell crank in full speed position

IDLE SPEED STOP (Diesel)

Recommended idle speed is 675 RPM. The idle stop screw on the injection pump is adjustable. However, it should not be necessary to adjust the idle speed unless new components have been installed. If so, adjust the screw to obtain an idle

TRACTOR AND FRAME MAINTENANCE

speed of 650 RPM (a little lower than the recommended idle), with the pump arm against the idle adjusting screw. Then adjust the linkage stop bolt on the bracket to stop the bell crank JUST BEFORE the pump arm would contact the idle screw. Adjusting in this manner will protect the pump linkage and will provide the correct idle speed of 675 RPM (Fig. 75).

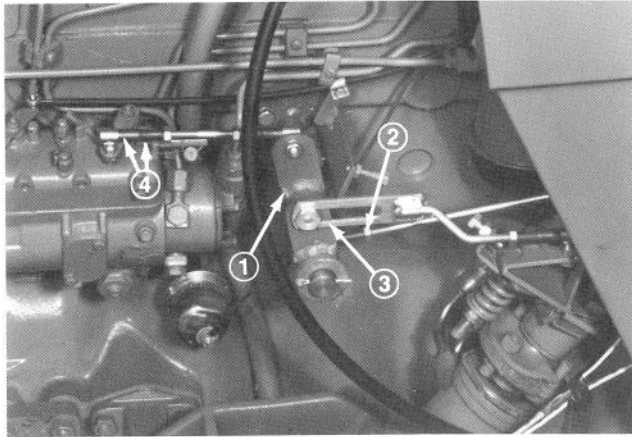

Figure 75

1. Bell crank-idle position
2. Linkage stop bolt (idle speed)
3. Adjust for contact here
4. Clearance between idle speed screw and pump arm

CLUTCH ADJUSTMENT

The clutch pedal free travel should be measured at least once a month. By pressing down on the clutch pedal with your hand, you will find that it will travel a certain distance before an added resistance is felt. Place a ruler along the side of the pedal and measure the amount of free travel. If the free travel is less than 3/8 of an inch (10 mm), the clutch must be adjusted. Recommended free travel should be 3/4 of an inch (19 mm) (Fig. 76).

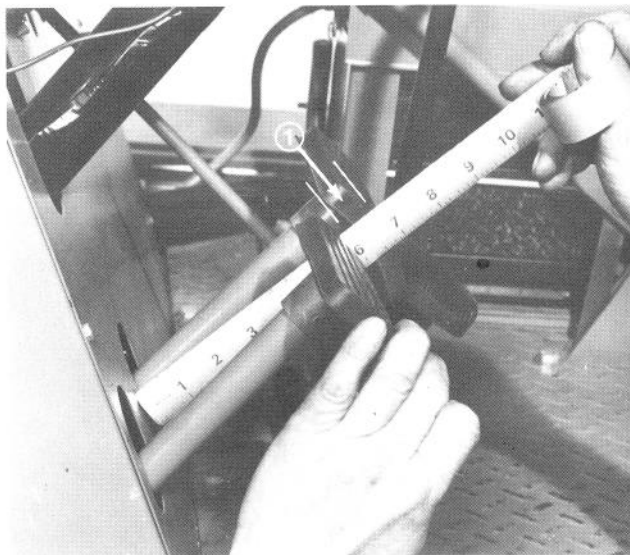

Figure 76

1. 3/4 in. (19 mm) free play

To adjust the clutch, remove the cotter pin and yoke pin at the clevis end of the clutch linkage (Fig. 77).

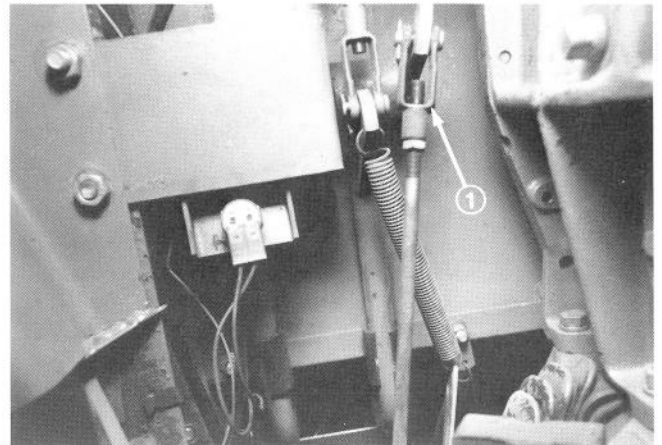

Figure 77

1. Clevis

Loosen the jam nut and turn the clevis about three turns. Connect the clevis and again measure the free travel. Repeat this operation until 3/4 inch (19 mm) free travel exists at the pedal. Secure the yoke pin with the cotter pin and tighten the jam nut.

DRIVE SHAFT UNIVERSAL JOINTS

If the universal joints develop excessive play or looseness, remove the U-bolts at rear of drive shaft and nuts securing shaft to transmission. Remove the shaft. Remove the snap rings and bearings. Reassemble with new bearings and secure with the snap rings (Fig. 78).

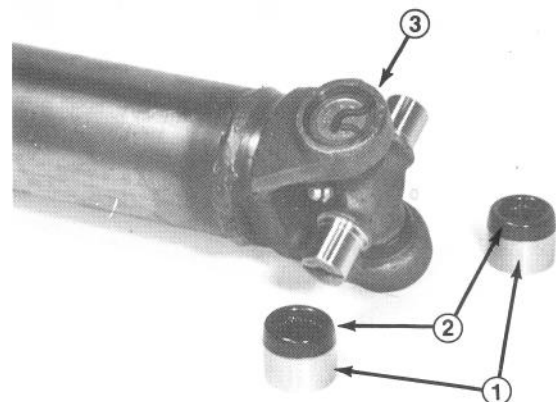

Figure 78

1. Needle bearing
2. Seal
3. Snap ring

If the drive shaft has been disassembled, reassemble with the clevises and arrows in line as shown in Fig. 79.

TRACTOR AND FRAME MAINTENANCE

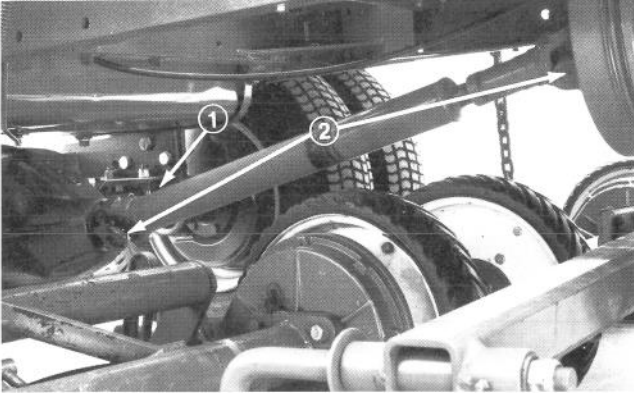

Figure 79

1. Arrows 2. In Line

PARKING BRAKE ADJUSTMENT AND SERVICE

The parking brake adjustment on the PARK-MASTER Tractor is very easy to make. When it is apparent that the brake needs adjustment, place the parking brake lever in the released position (forward). Remove cotter pin and pin securing clevis to brake assembly. Turn clevis in a clockwise direction about 4 turns and reinstall it to brake assembly with pin and cotter pin. Park the vehicle on a fairly steep slope with the rear of the tractor facing down hill and the transmission in neutral. Apply the parking brake. If it will not hold, release the brake and readjust clevis. Repeat until the unit will hold on the slope (Fig. 80).

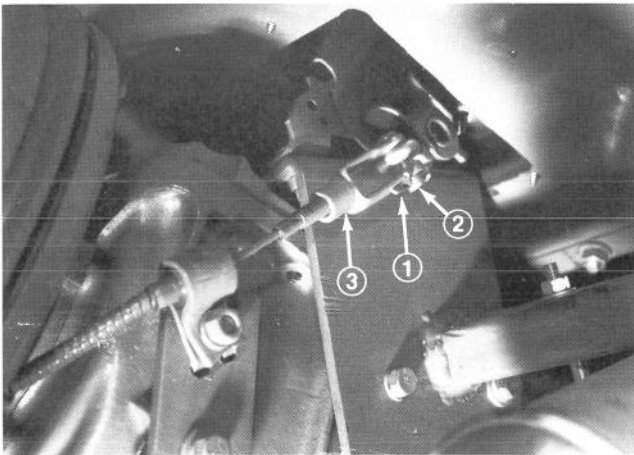

Figure 80

1. Cotter pin
2. Pin
3. Clevis

MASTER CYLINDER

Every 600 hours of operation (or when a brake problem is evident), check the level of the fluid in the master cylinder.

The cylinder is accessible through the hole in the floor plate. Clean the area around the hole and the cap on the master cylinder thoroughly before removing the cap to prevent the entrance of dirt into

the system. Add fluid as necessary and reinstall the cap. Make certain the vent hole in the cap is open at all times (Fig. 81).

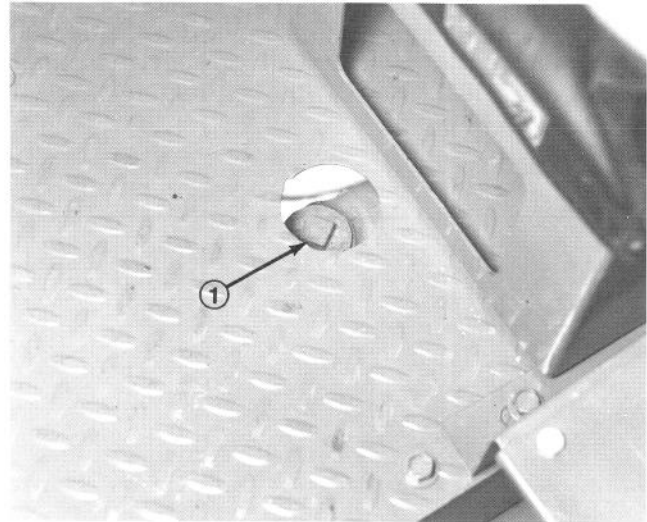

Figure 81

1. Master cylinder cap

BRAKE LINKAGE ADJUSTMENT

If the linkage from the brake pedal to the master cylinder is bent or otherwise damaged, it must be readjusted as follows:

1. Remove the cap from the master cylinder.
2. The reservoir must be about half full, so the fluid covers the piston.
3. Adjust the clevis so a turbulence can be seen in the fluid when the brake pedal is making its return stroke. This will make sure that the piston is making its full return stroke (Fig. 82).
4. Replenish the fluid in the cylinder as necessary and reinstall the cap.

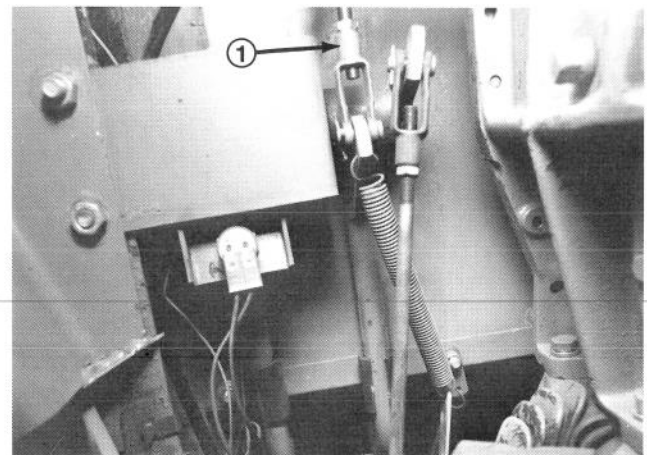

Figure 82

1. Clevis

TRACTOR AND FRAME MAINTENANCE

BLEEDING BRAKE SYSTEM

If the brake lines are ever disconnected for any reason, and air enters the system, the system must be bled.

Fill the master cylinder with brake fluid. Connect a bleed hose to the bleed screw and submerge the other end of the hose in brake fluid in a clean container. Loosen bleed screw and have a helper depress the brake pedal. Continue until air bubbles cease in container. It is important that end of hose remain submerged and that the master cylinder is continually refilled so that air is not allowed to enter. Tighten bleed screw and repeat operation for other wheel. It is recommended that the left brake be bled first and then the right brake. Discard brake fluid in container because it may be contaminated.

Check and fill master cylinder to full mark if required.

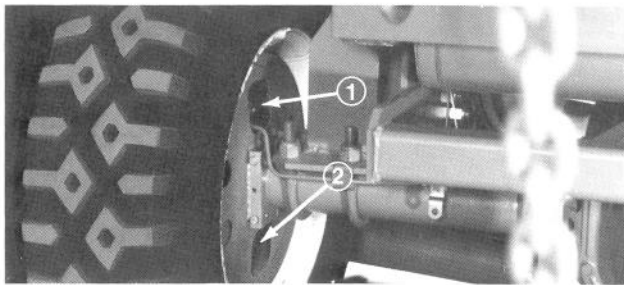



Figure 83
1. Bleed screw 2. Adjusting hole

BRAKE SHOES AND CYLINDERS

Replace brake shoes and install wheel and master cylinder kits, when required, using standard automotive procedures. See "WHEEL BEARINGS", page 49, for recommended procedures for reinstalling the rear wheel hub.

 **CAUTION**

Every 6 months, remove the rear brake drums and clean the brakes of all debris and material which could affect the function of the brakes; refer to Checking Brake Operation, page 23.

SERVICE BRAKE

DISASSEMBLY

1. Be sure the parking brake is released.
2. Remove wheel and drum. If shoes interfere with drum removal, hold adjuster lever away from star wheel (Fig. 89) while backing off adjustment.

Note: Check position of return springs, holddown parts and automatic adjuster parts so they can be re-installed in same position.

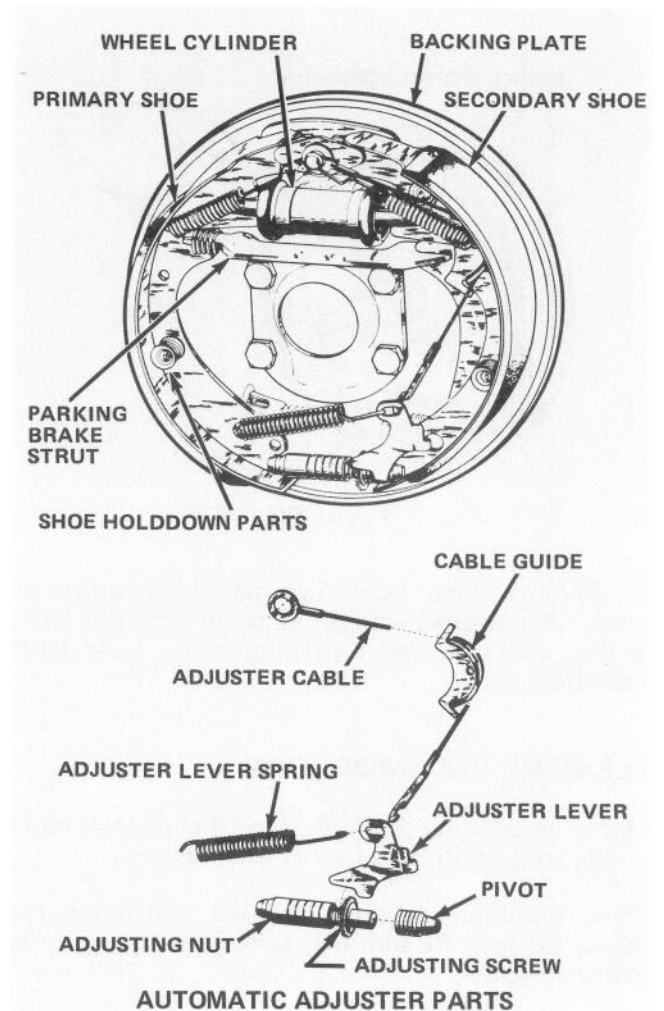

Figure 84
Left Rear Shown

3. Install wheel cylinder clamp (Fig. 85) to hold wheel cylinder pistons in place.

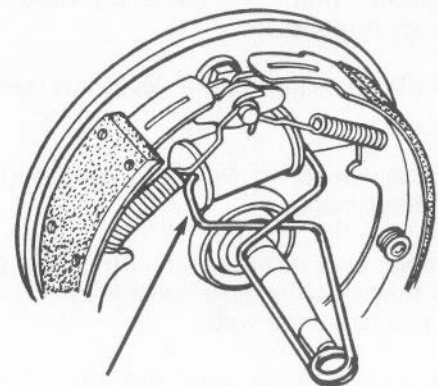

Figure 85

TRACTOR AND FRAME MAINTENANCE

4. Remove shoe return springs (Fig. 86) and automatic adjuster spring. Then remove automatic adjuster cable, cable guide, adjuster lever and shoe guide plate, if used.

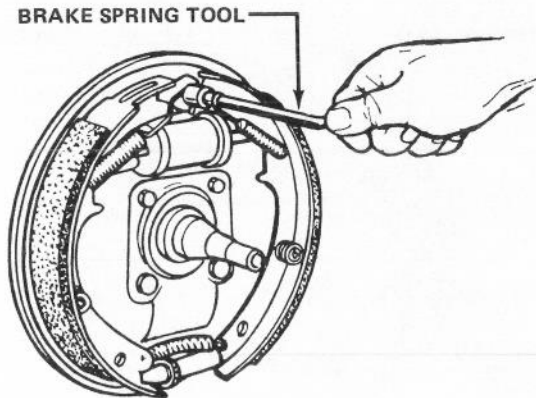

Figure 86

5. Remove shoe holddown parts and adjusting screw. Remove parking brake strut with anti-rattle spring, and disconnect parking brake lever from secondary shoe.

CLEANING AND INSPECTION

Clean the backing plate. Be sure that shoe support points are smooth and free of rough edges.

Clean the adjusting screw threads, and check for thread damage. Be sure that the adjusting nut turns freely on screw.

Check springs and other parts for loss of tension and damage. Replace weak springs and any damaged or badly worn parts.

RE-ASSEMBLY

1. Apply light coat of high temperature lubricant to shoe support points on backing plate and to adjusting screw threads.

2. Assemble parking brake lever on secondary shoe.

3. Assemble shoes on backing plate, and secure with holddown parts.

4. Assemble anti-rattle spring on parking brake strut, and then position strut between parking brake lever and primary shoe web.

5. Position shoe guide plate and loop of adjuster cable on anchor pin. Then install primary shoe return spring.

6. Position cable guide on secondary shoe web, and then install secondary shoe return spring. Be sure that wheel cylinder shoe links properly engage shoe webs. Remove wheel cylinder clamp.

7. Assemble adjusting screw between shoe webs at lower end.

8. Attach short hook end of automatic adjuster spring to primary shoe web.

9. Attach other end of spring and hook of adjuster cable to hole in adjuster lever. Then assemble lever, with spring and cable attached, on secondary shoe web.

ADJUSTMENT

When new linings are installed or when the position of the adjusting screw is changed, the brakes should be adjusted.

PRELIMINARY ADJUSTMENT USING GAUGE

If a brake shoe gauge (Fig. 87) is available, set gauge to inside diameter of drum, and tighten set screw.

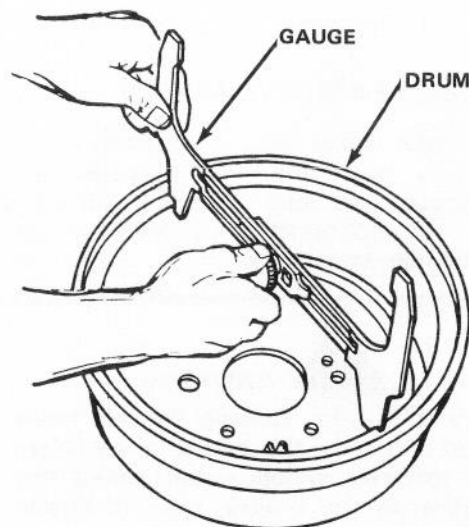

Figure 87

Position other end of gauge over brake shoes (Fig. 88). Then expand shoes by manually turning star wheel until gauge just slides over linings. Rotate gauge around lining surface to insure proper clearance.

TRACTOR AND FRAME MAINTENANCE

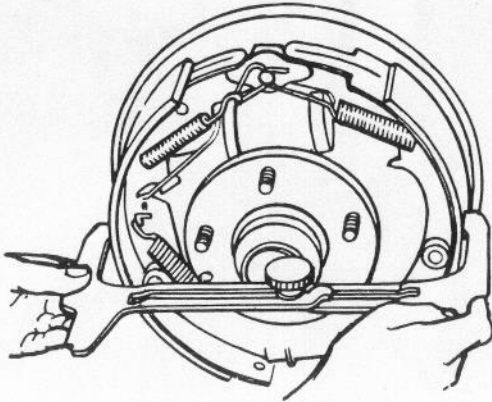

Figure 88

PRELIMINARY ADJUSTMENT THROUGH ACCESS SLOT

If a gauge is not available, the preliminary adjustment may be made through the adjusting screw access slot.

Remove cover from access slot in the backing plate.

Install drum on shoes. Then insert a brake adjusting tool through slot in backing plate, and turn star wheel to expand shoes until a heavy drag is felt while turning drum.

Back off star wheel until drum is free of drag (20 to 30 notches). Use a screwdriver (Figure 89) to hold adjuster lever away from star wheel while backing off adjustment.

Assemble cover in access slot.

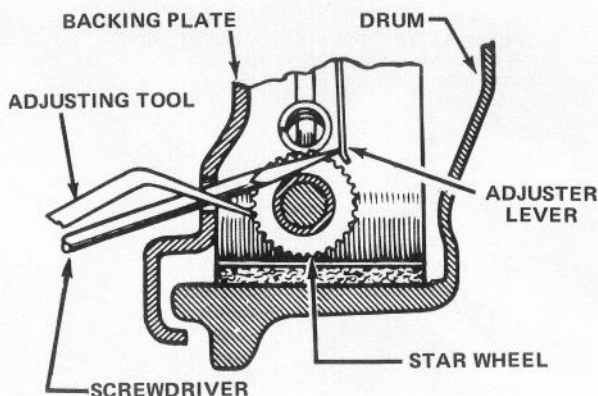

Figure 89

FINAL ADJUSTMENT



WARNING

After making preliminary adjustment, apply firm pressure to brake pedal and be sure that there is adequate pedal reserve before moving tractor.

Operate tractor and make a number of alternate forward and reverse stops applying firm pressure to brake pedal on each stop.

These stops should activate automatic adjusters and build up a normal pedal reserve.

FRONT AND REAR AXLE ASSEMBLY

FRONT WHEEL TOE-IN

The tie rod must be adjusted so the center-to-center distance at the front of the tires is 1/8 inch (3 mm) less than the center-to-center distance at the rear of the tires. Make the measurements at the height of the front axle (Fig. 90).

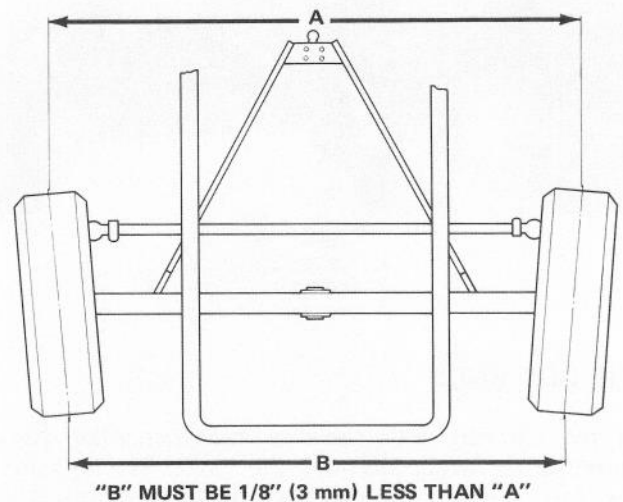

Figure 90

To adjust the toe-in, loosen the clamps at both ends of the tie rod, and turn the tie rod in the proper direction to get the required 1/8 inch (3 mm) toe-in. Tighten the clamps.

Note: Position the clamps so they will not hit the reach when the wheels are turned (Fig. 91).

TRACTOR AND FRAME MAINTENANCE

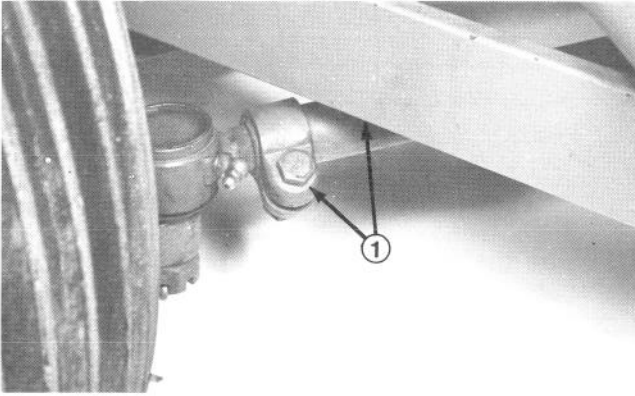

Figure 91

1. Clamp must not hit reach

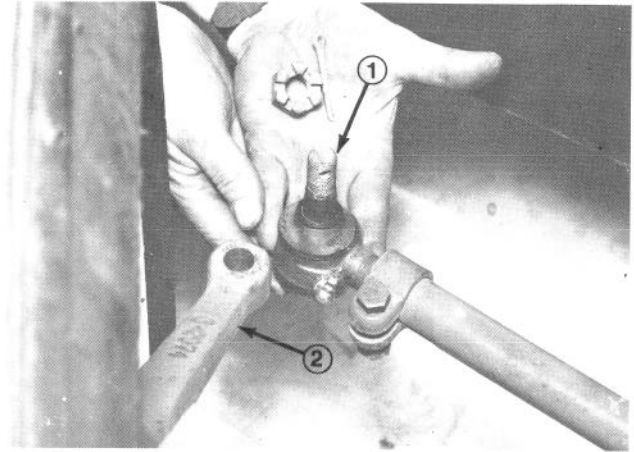

Figure 93

1. Tie rod end
2. Support arm firmly when removing rod end

WHEEL STOPS

First, adjust front wheel toe-in, page 47. Second, loosen jam nuts and adjust the three set screws so 1/8 inch (3 mm) of the screw extends through the yoke (Figure 92). Third, rotate steering wheel to make a full right turn. Fourth, adjust left front set screw until it contacts the "stop"; then bottom jam nut against yoke. Finally, back off right side set screw from 0.010 - 0.015 of an inch (0.254 - 0.381 mm); then bottom jam nut against yoke to maintain the adjustment.

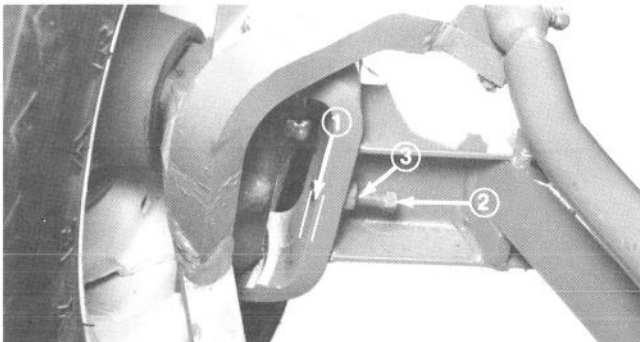

Figure 92

1. 1/8 in. (3 mm)
2. Set screw
3. Jam nut

DRAG LINK ENDS

If excessive play develops in the drag link ends, remove the cotter pin and tighten the end plugs snug, then back off to where the cotter pin can be inserted (Fig. 94).

If the ball studs are worn so badly that this adjustment will not remove the play, they must be replaced.

Remove the cotter pin, end plug, spring seat and spring. Turn the steering wheel back and forth to free the components.

To replace the front ball stud, remove the cotter pin, reverse the slotted nut on the threads, support the drag link arm, and drive the ball stud out of the tapered seat. Remove the nut and ball stud. Install the new ball stud.

IMPORTANT: When driving out the stud, support the arm firmly, and use extreme care to avoid breaking the arm (Fig. 94).

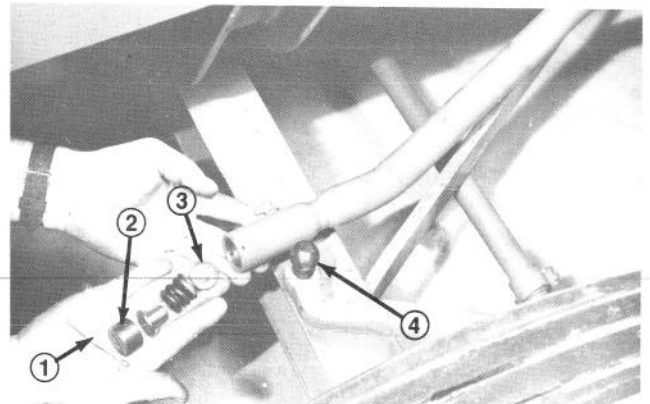

Figure 94

1. Cotter pin
2. End plug
3. Seat
4. Ball stud

TIE ROD ENDS

If the tie rod ends develop excessive play, they must be replaced. Remove the cotter key and slotted nut. Reverse the nut and install it on the stud until the threads are at least half engaged. Support the opposite side of the steering spindle securely to prevent breakage, and drive against the nut to free the rod end from the tapered hole in the spindle arm. Remove the nut and tie rod end. Install the new components and adjust the toe-in; refer to page 47.

Note: The right hand tie rod end has right hand thread; the left hand rod end has left hand thread (Fig. 93).

TRACTOR AND FRAME MAINTENANCE

The rear ball stud is an integral part of the pitman arm, and the entire assembly must be replaced. Note the position of the arm and install the new one in the same position. (There are 4 blank splines in the arm to aid in correct positioning). Tighten the arm nut to 180 to 210 ft-lb (245 - 286 N·m).

FRONT AXLE SPINDLES (Fig. 95)

If the spindle develops excessive play or looseness, the bearings and/or spindle pins must be replaced.

1. Jack up the front end and remove the wheel.
2. Drive out the retaining pin through the spindle pin. Remove retaining ring from pin.
3. Drive the spindle pin out of the fork and spindle. Remove the thrust bearing and needle bearings.
4. Pack the new bearings with #5 wheel bearing grease and install the components in reverse order of disassembly.

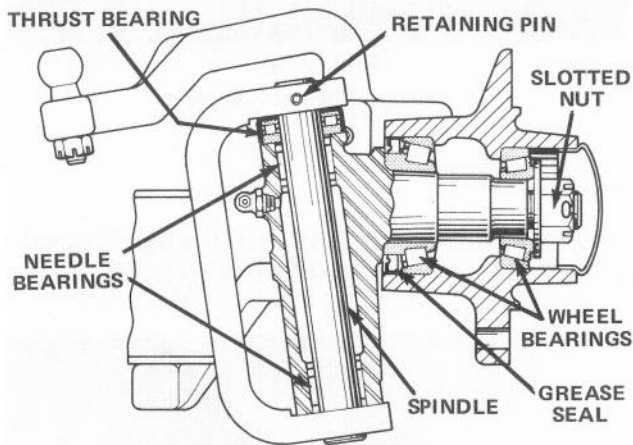

Figure 95

WHEEL BEARINGS

Front: To replace the front wheel bearings proceed as follows:

1. Jack up the wheel being serviced.
2. Remove the hub cap, cotter key, slotted nut, and washer.
3. Pull off the wheel and outer bearing cone. Remove the inner bearing cone and seal from the spindle.
4. Remove the bearing cups from the hub. Clean the hub with a solvent.

5. Press the new cups in the hub, being certain they are fully seated.
6. Pack the new cones with #5 wheel bearing grease.
7. Grease the sealing lip and slip the new seal on the extended race of the inner bearing cone.
8. Reassemble in reverse order of disassembly.
9. Tighten the slotted nut until the bearings bind slightly when rotating the wheel by hand. Back off the slotted nut to the nearest cotter pin hole and secure with a new cotter pin.
10. Reinstall the hub caps.

Rear: To replace the rear wheel bearings and seal, proceed as follows:

1. Jack up the side of the tractor being serviced.
- Note:** Jack it up so the wheels are several inches off the floor, and the rear axle will not have to be drained.
2. We recommend removing the rear tires and wheels to reduce the weight of the assembly.
 3. Remove the 8 nuts and taper bushings; then pull the axle shaft carefully out of the housing.
 4. Remove the gasket.
 5. Remove the two large nuts and lock-tab and remove the rear wheel hub and outer bearing from the housing.
 6. Remove the inner bearing cup and the grease seal from the housing.
 7. Remove the old bearing cones from the hub.
 8. Clean the housing and the inside of the wheel hub with a solvent.
 9. Coat the seal seating surface on the housing with No. 5 grease and install the new seal.

Note: Install the seal so it is flush or slightly past the shoulder of the seal surface. If it is forced on too far, the seal could become distorted and leak.

10. Install the inner bearing cup on the housing, making certain it is fully seated.
11. Pack the new bearing cones with No. 5 grease and press into the wheel hub.
12. Install the hub carefully over the seal and install the outer bearing cup.
13. Install the inner nut and tighten securely to seat the bearings. Back off the nut and retighten snug.

TRACTOR AND FRAME MAINTENANCE

14. Loosen the nut 90° and assemble lock-tab by loosening nut to the nearest hole.

15. Install the outer nut and tighten to 40 ft-lb (54 N·m) minimum.

16. Use a new gasket and reinstall the axle shaft, rotating as necessary to engage the splines at the inner end.

17. Install the 8 nuts and taper bushings and tighten evenly and gradually.

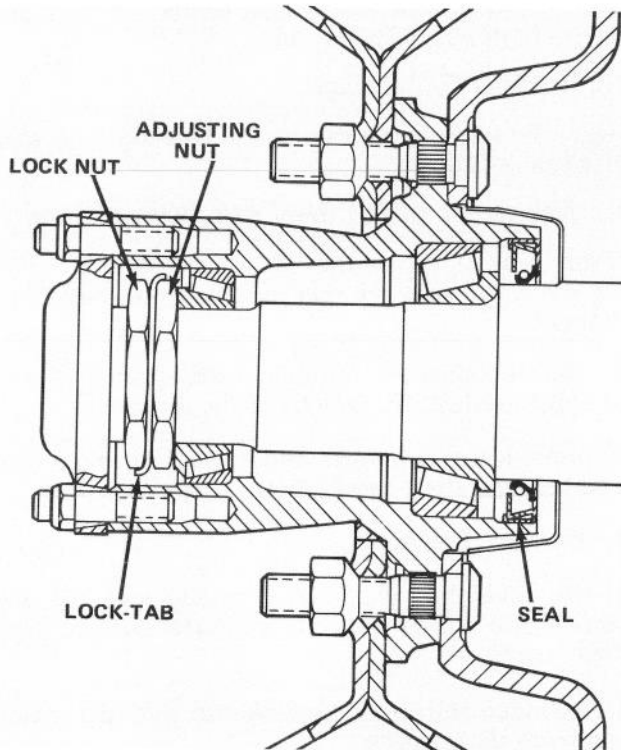

Figure 96

REAR AXLE U-BOLT LOCKNUTS

Every 600 hours check the torque of the locknuts securing the rear axle to the frame. There are four nuts on each side of the frame. Torque the nuts to 75-100 ft-lb (102 - 136 N·m) (Fig. 97).

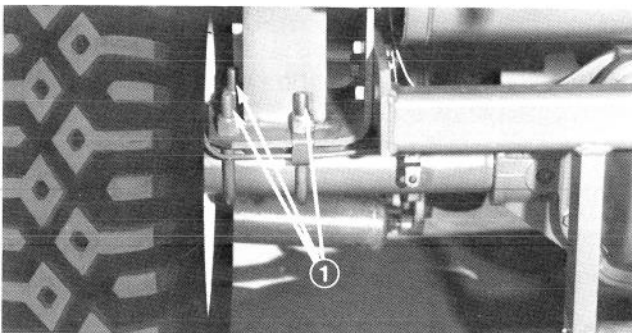

Figure 97

1. Torque to 75-100 ft-lb (102-136 N·m)

LIFT ARM FRAME MOUNTING NUTS

Check the torque on the mounting nuts securing the lift frame for the 2 & 3 lift arms every 600 hours. The proper torque for the four nuts is 150 ft-lb (204 N·m) (Fig. 98). Check the rest of the frame and tractor mounting fasteners at 600 hours to insure they are all properly torqued. Retighten any loose fasteners.

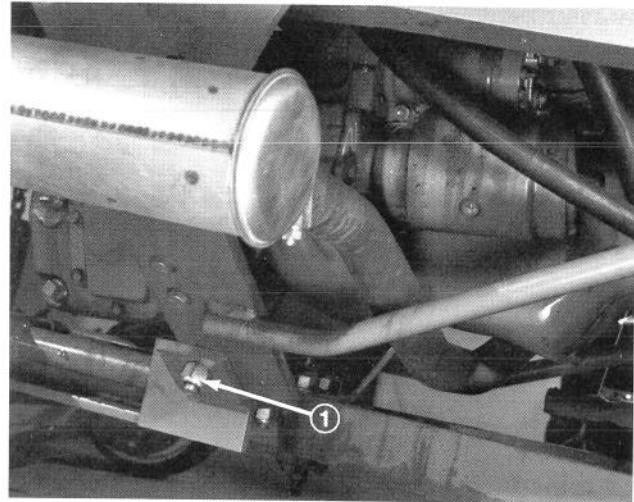

Figure 98

1. Torque to 150 ft-lb (204 N·m)

HOOD LATCH

Keep the U-bolts on the inside of the hood adjusted so the hood latches hold securely (Fig. 99).

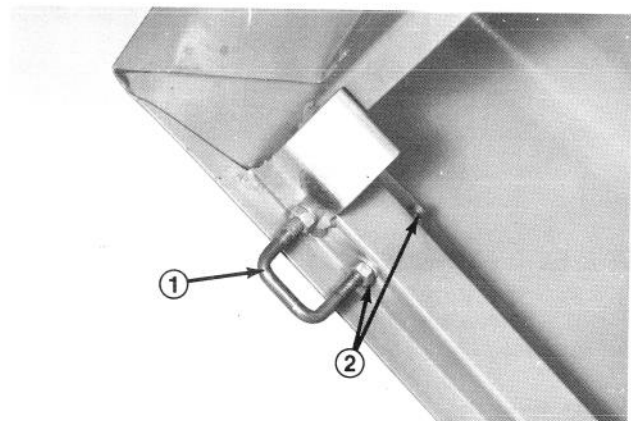

Figure 99

1. U-bolt
2. Adjusting and jam nuts

DRAWBAR (OPTIONAL FOR PARKMASTER)

The drawbar can be adjusted laterally to any set of holes in the frame, to position the trailing implement as desired.

TRACTOR AND FRAME MAINTENANCE

LIFT ARM BACKING REPLACEMENT

To replace the lift arm bushing (Figure 100) proceed as follows:

1. Position lift arm in the down position.
2. Remove nut from end of pin.
3. Remove capscrew from pin assembly.
4. Remove link between hydraulic cylinder and lift arm.
5. Remove bushings in lift arm.
6. Insert and size new bushings and replace pin.
7. Replace capscrew and nut.

IMPORTANT: It may be necessary to drive the pin assembly out of the lift arm.

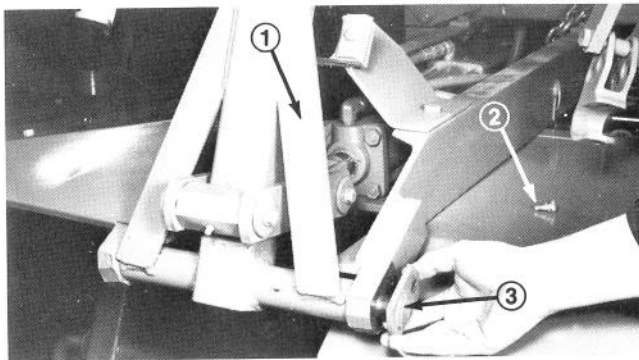

Figure 100

1. Lift arm
2. Capscrew
3. Pin assembly

HYDRAULIC PUMP (Diesel)

The hydraulic pump is coupled directly to the front crankshaft pulley (Fig. 101), and is equipped with a flow divider valve to operate both the frame hydraulic system and the tractor power steering system.

Should the pump need replacement, use the following procedures:

Disassembly:

1. Drain the reservoir, remove all lines and fittings from pump. Cap the lines and fittings to prevent contamination.
2. Remove the capscrew and locknut from the end of the torque arm and the three hub mounting capscrews from the crankshaft pulley (Fig. 101) and remove the pump.

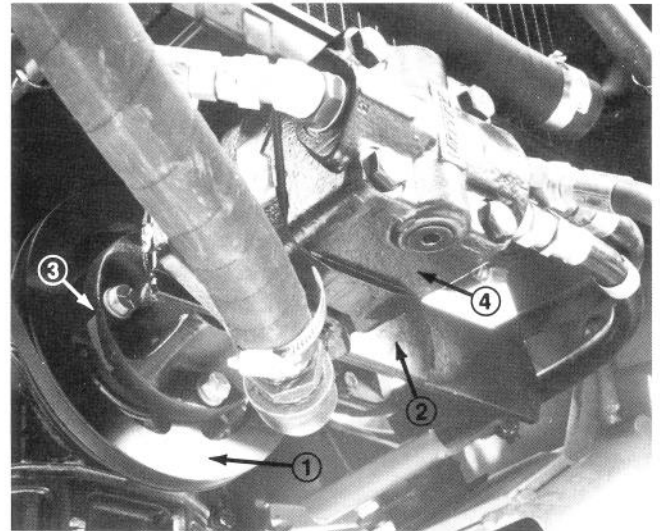

Figure 101

1. Crankshaft pulley
2. Torque arm
3. Hub
4. Pump

3. Loosen the setscrews in the hub and remove hub from shaft.
4. Remove capscrews and nuts securing torque arm to pump and remove torque arm.
5. Repair or replace parts as necessary.

Assembly:

1. Clean all burrs and excess paint from the hub mating face of the crankshaft pulley. The surface must be clean, flat and free of nicks or burrs.
2. Clean all paint from the hub mating face and pass a medium cut mill bastard file over the mating face to remove any burrs or imperfections. Finish off with a fine cut file making very light passes to accomplish a smooth clean surface.

TRACTOR AND FRAME MAINTENANCE

3. Mount the torque arm to the pump. Clean the pump shaft and I.D. of hub thoroughly to remove grease or oil and install the key in the pump shaft.
4. Install the hub making sure the shaft key does not extend past the hub face.
5. Install the hub and hub retainer capscrews. Torque the retainer screws to 90-120 in.-lb (10.2 - 13.6 N·m) and the hub capscrew to 240-320 in.-lb (27-36.2 N·m).
6. Bend a tab of the retainer clip against a flat of the mounting capscrew. Bend down or remove any portion of the tab extending above the capscrew and lock the hub setscrews with an allen wrench.
7. Install the pump and torque the mounting capscrews uniformly to 30-50 ft-lb (40.7 - 68 N·m) to prevent hub distortion.
8. Secure the end of the torque arm to the torque arm plate. Refer to Fig. 102 for proper assembly of parts.
9. Install lines and fittings and fill the reservoir to the proper level. Refer to Hydraulic Oil Level, page 30.

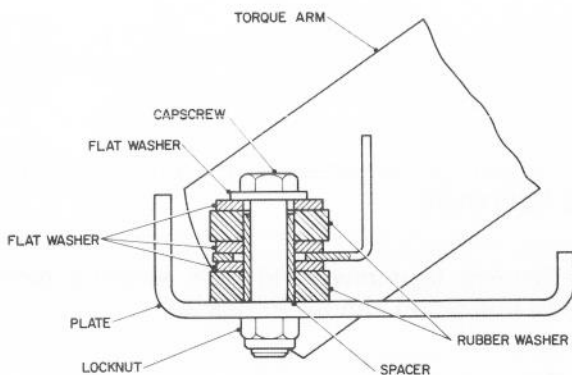

Figure 102

HYDRAULIC DIRECTIONAL CONTROL VALVE

Replacing, Adding or Removing Housing and Spool Assembly

Note: For the purpose of these instructions, we shall consider the section containing the Main Relief Valve as the left side of the valve.

1. If the valve is to be reassembled in the same order, it is suggested that before disassembling, each section be marked numerically so that they may be returned to the same sequence when reassembled.
2. If the valve has been removed from Parkmaster, it is advisable to mount valve vertically in a vise to facilitate disassembly and assembly.
3. Remove the three (3) assembly locknuts from right end section, using a thin-wall socket.
4. Valve sections may now be removed by sliding the sections along the assembly studs.
5. Thoroughly clean the O-Ring counterbores and the ground surface of each section. Place O-Ring Seals in proper counterbores. For better sealing, it is suggested that all O-Rings used in the counterbores be replaced with new parts.
6. Replace the sections on assembly studs with the O-Ring counterbores facing the right end of the valve. Use care in replacing sections so that the section O-Rings are not dislodged from the counterbores.
7. When all sections are assembled on assembly studs, tighten the assembly stud nuts evenly to 20 ft-lb (27.2 N·m) torque, NO MORE, NO LESS; spools may bind or stick.

REPLACING SPOOL SEALS

Note: For the purpose of these instructions, we shall consider the control handle side of the valve as the FRONT, and the opposite side as the BACK.

1. At the BACK of the valve, remove all bonnet assembly parts which are connected to the spool, and keep in the order of disassembly.
2. At the FRONT of the valve, remove all parts connected to the spool (handle, link).
3. Push spool into housing from the FRONT of the valve until front seal is exposed, then remove front seal. Pull spool out of housing from FRONT end, being very careful that neither spool nor bore is scratched or damaged in any way.
4. Remove back seal.
5. Thoroughly clean both seal grooves.
6. Replace the spool through the front of the housing being sure that the end having the tapped hole enters the housing first. Push the spool into the housing far enough to expose the FRONT seal groove. Insert a new seal in the FRONT groove.

TRACTOR AND FRAME MAINTENANCE

Pinch one side of the seal, causing the seal to bend into a shape slightly smaller than the seal groove in the valve. When the seal has been properly placed in the seal groove, straighten the seal by running a smooth rod around the exposed edge of the seal. You should have a smooth, perfect ridge without kinks or twists.

7. Apply a small amount of grease or heavy oil on the seal to protect it during assembly.

8. Pull the spool out toward the FRONT of the valve until the spool handle end is exposed. Insert a metal rod about 3 to 4 inches (7.6 to 10 cm) long, and up to 1/4 in. (6 mm) diameter through the spool handle pin hole for use as a handle. Pull the spool slowly past the seal with a twisting motion to assist the movement. Continue to pull the spool until the BACK seal groove is exposed. DO NOT

pull the spool too far as this will allow the seal in the FRONT seal groove to enter a spool groove and the seal will be cut when the spool is pushed back.

9. Install the new BACK seal in the same manner as the FRONT seal, taking care that the seal is not twisted or cut. Apply grease or heavy oil to the seal.

10. Push the spool into the housing past the back seal with a twisting motion until 5/8 in. (8 mm) of the polished surface of the spool remains exposed at the FRONT of the valve.

11. Reassemble all parts disassembled in Step No. 2.

12. Reassemble (in reverse order) all parts disassembled in Step #1. Use 12 ft-lb (6.3 N·m) torque to tighten assembly screw.

HYDRAULIC SYSTEM SCHEMATIC

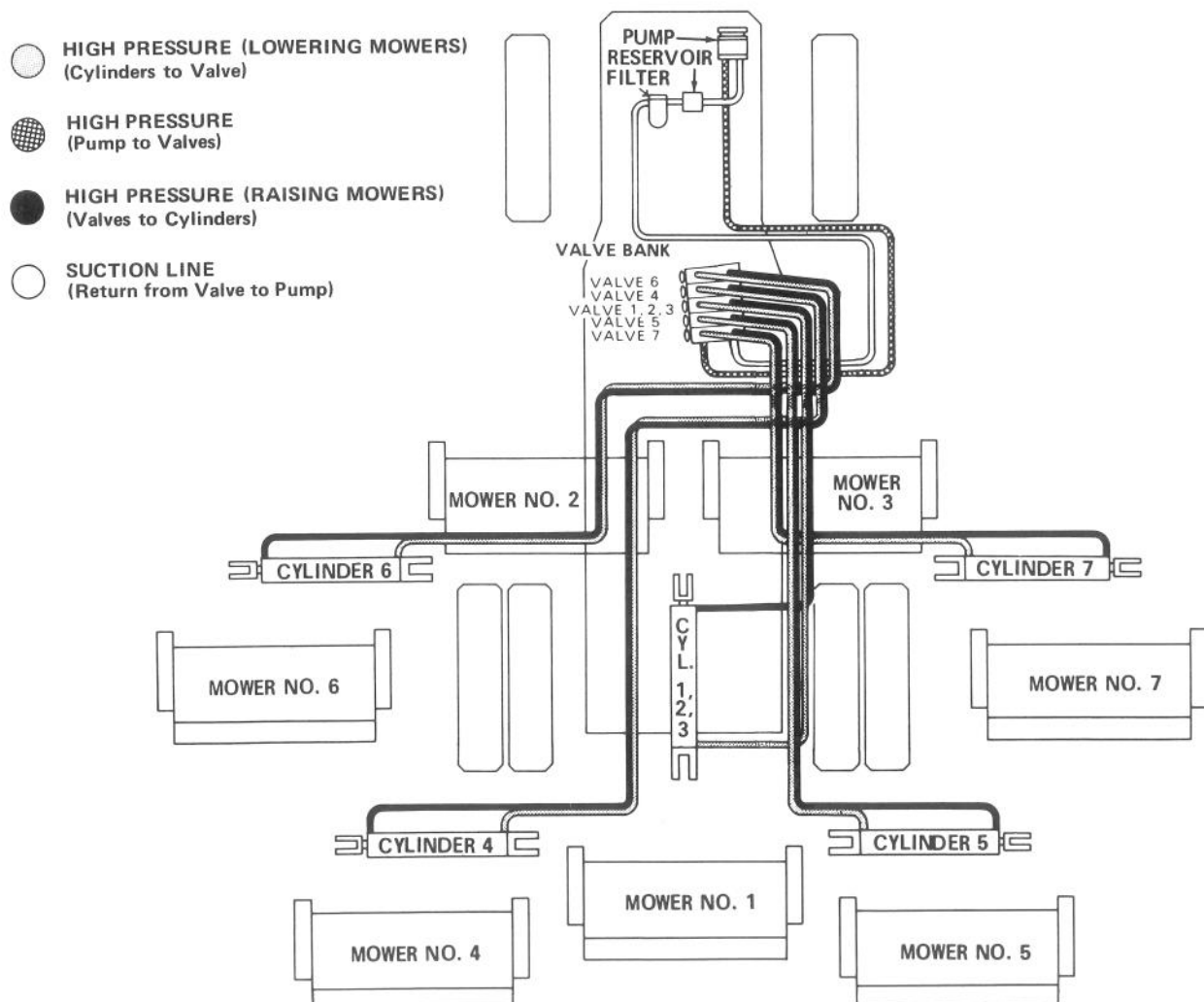

TRACTOR AND FRAME MAINTENANCE

WIRING SCHEMATIC

(Gasoline Tractor)

IMPORTANT: Make certain wires, connectors, etc., are located so they cannot short out to ground or against another component.

12 Volt
Negative Ground

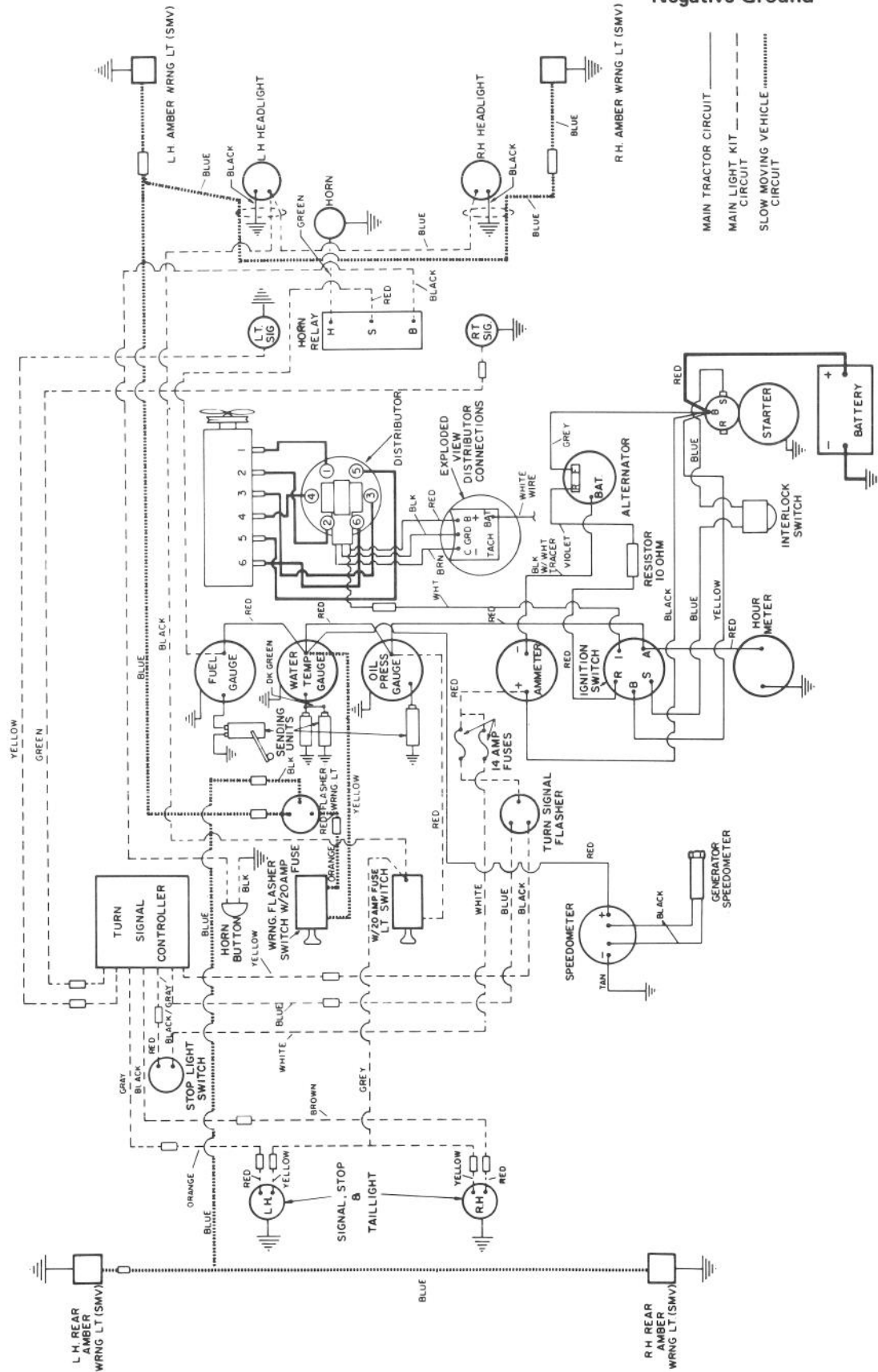

TIRE MAINTENANCE AND REPAIR

TIRE PRESSURES (TURF APPLICATION)

Keep the tires inflated as follows:

Rear:

7.50-16 20 PSI (137.8 kPa)

8.00-16 20 PSI (137.8 kPa)

Front:

9.50-14 22 PSI (151.7 kPa)

Note: The tubes are equipped with valves for liquid ballast if desired. See page 25. See page 10 for recommended tire pressure during operation on hard surfaces.



TIRE AND WHEEL SAFETY PRECAUTIONS

ALWAYS check rim diameter to be sure it exactly matches rim diameter molded on tire.

ALWAYS use new tubes and new flaps in new tires.

ALWAYS check to be sure tube is clean before installing in tire.

ALWAYS inspect inside of tire for dirt, liquids, or foreign material and remove before installing tube.

ALWAYS clean and inspect used rim parts. Replace worn or damaged parts.

ALWAYS inspect inside of tire for loose cords, cuts, penetrating objects, or other carcass damage. Repairable damage should be repaired before installing tube. Tires with unrepairable damage should be discarded.

ALWAYS inspect valve cores for proper air retention. Replace damaged or leaky cores.

ALWAYS remove valve core and deflate tire completely before removing from vehicle (both tires if duals) before loosening mounting bolts.

ALWAYS inflate tires in a safety cage, enclosed on all sides, including top or use a portable safety device. Use extension hose with gauge and clip-on chuck so that operator may stand aside during inflation (Fig. 103).

ALWAYS inflate tire to tire manufacturer's recommended cold operating pressure.

ALWAYS lubricate with only thin vegetable oil soap solution or other approved rubber lubricant. Never use anti-freeze, silicones or petroleum base lubricants.

ALWAYS use specialized tools as recommended by tire suppliers for mounting and demounting of truck tires.

NEVER allow anyone to mount or demount tires without proper training.

NEVER install tubes or flaps that have buckled or creased or been damaged beyond repair.

NEVER use a tube in a casing larger or smaller than that for which the tube was designed by the manufacturer.

NEVER work on an inflated tire and rim assembly.

NEVER re-inflate a tire that has been run flat or seriously underinflated without removing and checking for tire, tube or rim damage.

FRONT AND REAR TIRE REPAIR

Tools Required: Two ton jack, jack stand, wheel wrench, core remover, safety cage, one pair Ken-Tool T45 Tools, wire brush, vise grip, pliers, two TO-399 tire changing tools, one rubber mallet, commercial bead lubricant (non-water base), extension hose with gauge and clip-on chuck, bead expander.

Note: Special tools for tire removal and mounting are available from your local Goodyear Tire Dealer.

DEMOUNTING

1. Lock parking brake, block rear wheels. Jack tractor up, place jack stand under front axle if front tire is to be repaired, under rear axle if rear tire is to be repaired.

2. Remove valve core and completely deflate tire (both tires, if rear duals are being repaired). Run a piece of wire through stem hole to insure it's unplugged. Remove wheels and tires from tractor.

3. Place tire and wheel on floor, position TO-399 tool so flat end can be driven between bead and tire flange. Straighten tool to vertical position and hammer on tool neck with rubber mallet until bead separates from wheel. Repeat at 8 in. (20 cm) intervals until bead is totally separated. Turn wheel over and repeat process.

4. Step on tire opposite valve to push bead into well. Insert curved ends of T45 tools between tire and wheel five inches (12.7 cm) on either side of valve with stops on tools against wheel flange. Pull one tool toward wheel center, then pull second tool in same direction. Leave one tool in position, take other tool out and re-insert curved end between bead and flange 4 in. (10 cm) from other tool. Pry bead free of rim. Repeat process at 4 in. (10 cm) intervals until bead is free of wheel rim.

TIRE MAINTENANCE AND REPAIR

5. Stand tire assembly in vertical position, insert straight end of T45 tool between beads and both rim flanges and hook stop on tool over the second flange. Position tool at 90° angle to wheel and tire assembly and lubricate bead areas on both sides of tool. Lean tire assembly toward tool and rock or bounce assembly to pry wheel out of tire.

MOUNTING

1. Clean wheel rim and well area thoroughly of all rust, dirt, or foreign material. Inspect closely for cracks, excessive wear, damage or severely rusted rims. Replace the wheel with a new wheel of the same size and type if any part looks questionable. Repaint rim, if wheel passes inspection, to curtail corrosion.



DANGER

Do not, under any circumstances, attempt to rework, weld, braze, or heat any rim/wheel components that are cracked, broken, or damaged. Failure to comply with these procedures may result in faulty positioning of the tire and/or rim parts, and cause the assembly to burst with explosive force, sufficient to cause serious physical injury or death. Never mount or use damaged tires or rims.

2. Replace valve stem. Inspect inside of tire for loose cords, cuts, penetrating objects, or other carcass damage. Either repair or replace tire. Use tires of the correct size only. **DO NOT SUBSTITUTE.**

3. Position rim on floor so tire beads will be mounted over wheel flange closest to drop center well. Mount tire and push bead over flange as far as possible with foot. Lubricate remainder of first bead.

4. Insert straight end of T45 tool between bead and wheel flange with stop against flange. Use short successive bites in a circular motion to work bead over flange. Follow tool with foot, pushing down as bead is worked over flange.

5. Start second bead into well and hold it in place with foot or vise grips clamped to wheel flange. Lubricate bead halfway around. Insert curved end of T45 tool between bead and flange with

stop toward the wheel. Push tool outward to work tire over flange. Repeat operation in successive small bites, taking care so as not to damage tire bead, until you are two or three bites beyond lubricated portion of bead. Use your foot to hold bead in well of wheel.

6. Lubricate rest of bead and continue to pry bead over flange. It will be necessary to use both T45 tools to force the remaining bead over the flange when only a small area of bead is left out of well.

7. Stand tire inside safety cage, install clip-on chuck and insure inflation hose is long enough to allow you to stand to the side of tire (Fig. 103).

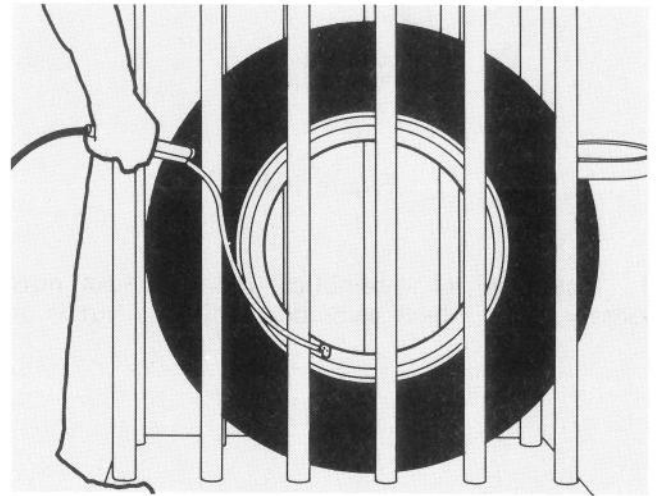

Figure 103



DANGER

Do not stand in front or in back of tire assembly. The air pressure in a tire and wheel assembly may cause assembly to burst.

8. Inflate the tire to the proper pressure. If air escapes, use bead expander to force tire beads against flange.

9. Remount wheel onto tractor. Torque the front wheel mount bolts to 40-60 ft-lb (54 - 81 N·m). Refer to Installing Dual Wheel and Tire Assembly, page 58, for installing rear wheels.

TIRE MAINTENANCE AND REPAIR

INSTALLING DUAL WHEEL AND TIRE ASSEMBLY

As the wheel taper direction is inverse to the adjoining wheel mount holes, use the following procedures to properly install the dual wheel assemblies (Fig. 104).

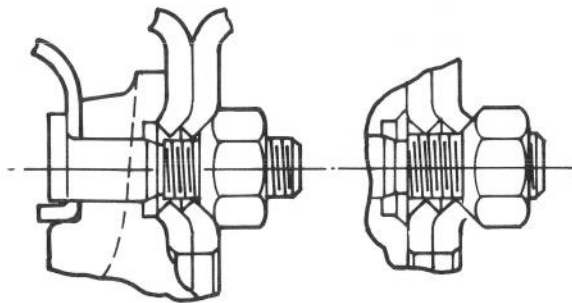

DUAL WHEEL
TAPER FLANGES

Figure 104

1. Install wheel assemblies, mount wheel nuts loosely, turn wheel assembly until one nut is at

top of bolt circle (Fig. 105) and just snug the top nut.

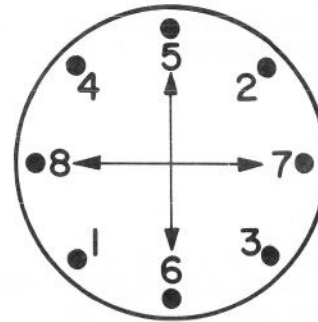

DUAL WHEEL
LUG NUT TIGHTENING
SEQUENCE

Figure 105

2. Snug the remaining nuts in a criss-cross pattern to minimize run-out (Fig. 105).

3. Finish by torquing the nuts alternately and evenly to avoid excessive run-out to 130-180 ft-lb (176 - 244 N·m).

RECOMMENDED PROCEDURE FOR STORAGE (Gasoline)

If you wish to store the Parkmaster Tractor for a long period of time, the following steps should be accomplished prior to storage:

1. Wash and clean exterior of unit.
2. Place the transmission lever in the neutral position and apply the hand brake.
3. Place all frame lift arms in transport position.
4. Lubricate frame.
5. If unit is stored with mowers attached, coat cutting edges of reels and bed knives with grease.
6. WITH THE ENGINE WARM, drain the engine oil and replace the drain plug.
7. Refill the oil pan to 1/2 its normal capacity with clean, high grade, SAE 50 oil.
8. Start the engine and run at about 700 RPM for at least one minute, but NO MORE THAN 2 minutes, to complete oil distribution to all surfaces.
9. Stop the engine and remove all of the spark plugs.
10. Pour 3 ounces (89 mL) of SAE 50 engine oil into each of the spark plug holes.
11. Disconnect the white wire leading to the distributor and crank the engine with the starter for at least a dozen revolutions to distribute the oil over the cylinder walls and valve mechanism.
12. Replace all spark plugs, the white distributor wire, and all spark plug wires.
13. Drain the oil from the engine pan and replace the drain plug. Fill with regular weight oil.
14. Drain the coolant by opening the petcock at the bottom of the radiator AND the one at the left side of the engine block. After all the coolant has drained, close both of the petcocks.
15. Drain all the gasoline from the fuel tank, lines, and carburetor bowl.
16. Make certain that the oil filler cap, gas tank cap, and the radiator cap are securely in place.
17. Seal the air cleaner inlet and the exhaust outlet with weather-proof masking tape. Prior to applying the masking tape, wipe all oily or greasy surfaces to which the tape must adhere with a rag saturated with cleaning solvent. After the oil or grease is removed, wipe the surface dry with a clean, dry rag.
18. Disconnect and remove the battery from the tractor. Coat the terminals with a light coating of petroleum jelly or gun grease. If possible, the battery should be stored in a COOL, DRY place. About once a month, check the liquid level and specific gravity of each cell. When the battery has a full charge, the specific gravity should be 1.250.
19. Jack up the front of the tractor until the wheels are just off the ground and place blocks under the front axle.
20. Jack up the rear of the tractor in the same manner as above and place blocks under the rear axle.
21. If possible, cover the entire unit with a heavy piece of plastic or a canvas drop-cloth.
22. Drain engine oil and replace with recommended oil when taking unit out of storage.

Note: Refer to the Perkins Engine Handbook for proper diesel engine storage instructions. Items listed above which do not refer to the engine should be followed whenever a diesel engine powered tractor is to be stored.

TROUBLE SHOOTING CHART

This Trouble Shooting Chart is intended as a guide to assist in correcting some of the common problems which may occur. Most of the "Remedies" can be performed with common hand tools. The

Chart is not intended as a guide for major overhaul procedures. For problems which are not covered in this Trouble Shooting Chart or this Operator's Manual, consult your TORO Distributor.

SECTION I – CHEVROLET ENGINE

HARD STARTING

TROUBLE	POSSIBLE CAUSE	REMEDY
Slow Cranking	Heavy engine oil.	Change to lighter oil.
	Partially discharged battery.	Charge battery.
	Faulty or undercapacity battery.	Replace battery.
	Poor battery connections.	Clean and tighten or replace connections.
	Faulty starter solenoid.	Replace or repair solenoid.
	Faulty starting motor or drive.	Overhaul starting motor.
Low Cylinder Compression	Burned or warped valves.	Overhaul cylinder head.
	Improper valve lash.	Adjust to proper clearance.
	Worn or broken piston rings.	Overhaul engine.
	Defective cylinder head gasket.	Replace gasket.
Lack of Fuel	Fuel lines clogged.	Clean fuel lines.
	Low fuel supply.	Check amount of fuel in tank, fill if supply is low.
	Clogged vent in fuel tank cap.	Clean or replace cap.
	Break in fuel supply line allowing air to be drawn into fuel line.	Replace or repair lines.
	Clogged fuel filter or filters.	Service filters as recommended.
	Water or ice in fuel system.	Thaw if frozen, and drain water out of tank and filters.
	Defective fuel pump.	Make pressure test at pump outlet.
	Dirty carburetor.	Clean carburetor.
	Carburetor choke inoperative, or not properly adjusted.	Check choke operation and adjust as necessary.
Ignition troubles	Defective electronic module.	Replace module.
	Defective pick-up coil.	Replace pick-up coil.
	Faulty spark plugs.	Clean or replace and adjust spark plug gap.
	Defective wiring.	Inspect wiring and correct as required.
	Ignition out of time.	Set ignition timing.
	Cracked distributor cap.	Replace.
	Defective ignition coil.	Test coil; replace if necessary.
LACK OF POWER		
Poor Compression	Incorrect valve lash.	Adjust to correct clearance.
	Leaky valves.	Remove cylinder head and grind valves.
	Valves or lifters sticking.	Free up or replace.
	Weak or broken valve springs.	Replace defective springs.
	Valve timing incorrect.	Correct the valve timing.
	Blown cylinder head gasket.	Replace gasket.
	Broken or stuck piston rings.	Free up or replace piston rings.
	Worn pistons, ring, and/or cylinder bores.	Overhaul engine.

TROUBLE SHOOTING CHART

SECTION I – CHEVROLET ENGINE

LACK OF POWER (Continued)

TROUBLE	POSSIBLE CAUSE	REMEDY
Lack of Fuel	Dirt or water in carburetor.	Clean carburetor.
	Gas lines partly clogged.	Clean gas lines.
	Dirt in gas tank.	Clean gas tank.
	Air leaks in gas line.	Tighten and check gas lines.
	Fuel pump not functioning properly.	Replace or repair fuel pump.
Excessive Fuel (Flooding)	Choke not fully open.	Check choke and adjust control.
	Air cleaner restricted.	Service air cleaner.
	Carburetor float valve not seating.	Clean float valve and set float level.
	Rich mixture at idle speed.	Adjust carburetor idle mixture.
Faulty Acceleration	Defective carburetor.	Repair or replace carburetor.
	Defective governor.	Repair or replace governor.
	Air leak at intake manifold.	Replace gaskets and/or manifold.
	Faulty ignition wiring.	Inspect for excessive resistance and defective insulation.
	Misfiring spark plugs.	Clean and/or replace spark plugs.
	Lack of cylinder compression, due to worn piston rings, burned valves, or defective head gasket.	Replace defective parts or overhaul engine.
	Exhaust back pressure too high.	Replace or repair defective exhaust system components.
OVERHEATING		
Overheating	Loose or defective fan belt.	Adjust or replace belt.
	Thermostat not opening.	Replace thermostat.
	Coolant loss.	Check for leaks and repair as necessary.
	Partially clogged radiator.	Clean radiator core internal passages and air passages.
	Defective water pump.	Repair or replace pump.
	Incorrect ignition or valve timing.	Retime engine.
	Dragging brakes.	Adjust or repair brakes.
	Restricted exhaust system.	Clean or replace exhaust system components.
	Improper valve clearances.	Adjust valve clearance.
	Ignition distributor advance inoperative.	Repair distributor to correct malfunction.
Overloaded vehicle.	Reduce load per vehicle rating.	
ROUGH IDLE AND/OR STALLING		
Erratic running or surging	Idle mixture too rich.	Adjust idle mixture screws.
	Improper ignition timing.	Set timing.
	Vacuum leak (air entering intake manifold).	Replace gasket, or tighten manifold bolts.
	Inoperative crankcase ventilation valve.	Clean or replace valve.
	Cylinder head gasket leaking or, cylinder head cracked.	Replace cylinder head or gasket.
	Worn valve guides.	Overhaul cylinder head.
Stalling	Engine idle speed set too slow.	Adjust idle speed to specifications.
	Engine running too cool.	Install proper thermostat.
	Exhaust restricted.	Repair exhaust system to eliminate excessive back pressure.
	Carburetor flooding.	Replace defective float valve, set carburetor float level. Check fuel pump for excessive pressure.
	Defective fuel pump.	Replace pump.

TROUBLE SHOOTING CHART

SECTION I – CHEVROLET ENGINE

DETONATION

(SPARK KNOCK OR PING ON ACCELERATION)

TROUBLE	POSSIBLE CAUSE	REMEDY
Spark knock or ping on Acceleration	Ignition advance too far for fuel being used.	Retard ignition timing.
	Wrong type (heat range) spark plug.	Install correct spark plug.
	Excessive build-up of deposits in combustion chambers.	Clean combustion chambers.
	Restricted coolant passages in cylinder head causing "hot spots" in combustion chamber.	Remove cylinder head and clean passages.
	Overheated engine.	Make corrections to lower the engine operating temperature. (Refer to "Causes" and "Remedies" previously covered under "Overheating.")
	Lugging engine.	Use lower transmission gear to prevent overloading engine.
HIGH LUBRICATING OIL CONSUMPTION		
High Oil Consumption	Oil lines or connections leaking.	Tighten or replace defective parts.
	Leaking gaskets.	Replace gaskets as necessary.
	Crankcase oil level too high.	Drain crankcase and refill to correct level.
	Crankshaft oil seals worn.	Replace oil seals.
	Pistons and/or rings worn, or pistons damaged; cylinder bores scored or worn.	Overhaul engine.
LOW ENGINE OIL PRESSURE (When checked with engine at normal operating temperature)		
Low Engine Oil Pressure	Defective oil gauge or sending unit.	Check pressure with master gauge. Replace oil gauge or sending unit if defective.
	Oil viscosity too low.	Fill crankcase with correct oil.
	Oil diluted with gasoline.	Check for indications of choke malfunction, carburetor flooding or a leaky fuel pump diaphragm allowing gasoline to enter crankcase. Make necessary correction.
	Suction loss.	Check for loose intake pipe and screen in oil pan. Also check for partially clogged inlet screen.
	Weak or broken relief valve spring in oil pump.	Inspect spring and replace if necessary.
ENGINE NOISE		
Valve Mechanism Noise	Sticking valves.	Clean and lubricate valve stems.
	Incorrect valve lash.	Adjust valve lash.
	Bent push rod(s).	Determine and correct cause of push rod bending. Install new push rod.
	Worn rocker arms and/or shaft.	Replace worn parts and make sure oil is reaching valve rocker arms.
	Broken valve spring.	Replace spring.
	Damaged valve lifter and/or camshaft.	Replace lifter and/or camshaft.
Bearing Noise	Insufficient oil supply.	Check oil level and add oil as required.
	Low oil pump pressure.	Remove and inspect oil pump and inlet screen. Make necessary corrections.
	Thin or diluted oil.	Change oil. Use oil with proper viscosity.
	Excessive bearing clearance.	Remove oil pan and make bearing replacement or repairs.
	Piston pins loose fit in connecting rod or piston.	Install new piston pins (oversize pins if required).
	Piston to cylinder bore clearance excessive (piston slap).	Overhaul engine.

NOTE: When diagnosing engine noise problems, be careful that noises caused by accessories such as governor or hydraulic pumps are not mistaken for engine noises. Removal of accessory drive belts will eliminate any noises caused by these units.

TROUBLE SHOOTING CHART

SECTION IA – PERKINS DIESEL ENGINE

TROUBLE	POSSIBLE CAUSE	REMEDY
Engine will not start	1. No Fuel at Injectors	
	a) Stop control in "no fuel" position.	Push control to "run" position.
	b) Insufficient fuel in tank, air has been drawn into the system.	Replenish fuel tank, then "bleed" system as detailed in Perkins Handbook.
	c) Fuel lift pump inoperative.	Remove lift pump and rectify or fit replacement pump.
	d) Fuel filters choked or fuel feed pipe blocked.	Check fuel feed to fuel pump and filters.
	e) Fuel pump not delivering fuel to the injectors.	Remove pump for attention of Authorized TORO Distributor and fit replacement. Check fuel pump drive.
	2. Fuel at Injectors	
	a) Injectors require servicing.	Service or fit replacement set.
	b) Valve and/or pump timing incorrect.	Check and reset.
	3. Cranking Speed Too Low:	
	a) Battery discharged	Fit fully charged replacement.
	b) Incorrect grade of lubricating oil.	Check oil viscosity against list in Perkins Handbook for temperature range.
	c) Poor electrical connections between battery and starter motor.	Check and tighten or remake connections where necessary.
	d) Starter motor faulty.	Replace or repair.
	4. Poor Compression	
	With poor compression, starting may be difficult in warm weather, but in cold weather the engine may refuse to start. The causes are numerous: worn liners, piston rings, leaking valves, etc.	A top overhaul or a complete overhaul is indicated.
	5. Clutch Pedal Not Depressed	An interlock switch must be actuated by clutch lever for engine to crank and start. Depress clutch pedal.
Engine starts, runs for a few moments, then stops	a) Partially choked fuel feed pipe or filter.	Trace and rectify.
	b) Fuel lift pump not giving adequate delivery.	Check output of lift pump and rectify or replace.
	c) Fuel tank vent hole blocked.	Unblock.
	d) Restriction in induction or exhaust systems.	Check and clear restrictions.
	e) Air leaking into fuel pipes.	Trace and rectify.
Engine misfiring or running erratically	a) Injectors require attention.	Isolate, remove and test.
	b) Air in fuel system.	Trace and rectify.
	c) Water in fuel pump.	Trace and remove.
	d) Valve and/or pump timing incorrect.	Reset if necessary.
	e) Valve clearances incorrect.	Reset if necessary.
	f) Fuel leaking from high pressure pipe.	Replace pipe.
	g) Faulty fuel injection pump.	Replace for comparison.
	h) Mismatching of fuel injection equipment.	Check parts list for correct parts.
Engine runs evenly but suffers from loss of power	a) Injectors require servicing.	Service or fit a replacement set.
	b) Loss of compression.	Top or major overhaul.
	c) Fuel injection pump not delivering sufficient fuel.	Check throttle linkage travel. Replace pump for comparison.

TROUBLE SHOOTING CHART

SECTION IA – PERKINS DIESEL ENGINE

TROUBLE	POSSIBLE CAUSE	REMEDY
Engine runs evenly but suffers from loss of power	d) Air cleaner restriction.	Service air cleaner.
	e) Fuel pump timing incorrect.	Check and reset.
	f) Brakes binding causing excessive load on engine and apparent loss of power.	Check brake drum(s) for overheating.
Engine runs but with a smoky exhaust	a) Incorrect air/fuel ratio.	Check for restriction to air flow.
	b) Valve and/or fuel pump timing incorrect.	Check and reset.
	c) Injectors require servicing.	Service or fit a replacement set.
	d) Excessive oil consumption.	New rings not seated.
	e) Vehicle over-loaded.	Check that the loading is consistent with the manufacturer's load classification.
Engine knocking.	a) Faulty injector (nozzle needle sticking).	Replace.
	b) Fuel pump timing too far advanced.	See your TORO Distributor.
	c) Piston striking a valve.	Check valve timing, piston heights and valve head depth relative to cylinder head face.
	d) Incorrect fuel.	Check that the tank has been filled with diesel fuel and not gasoline.
	e) Worn or damaged bearings, etc.	Overhaul engine.
	f) Piston slap—worn bores or rings.	Rebore and/or re-ring.
Engine overheating	a) Coolant level too low.	Replenish and check if leakage is taking place.
	b) Radiator or system blocked.	Flush system to remove sediment or scale.
	c) Blockage or restriction due to ice formation.	Observe frost precautions.
	d) Fan belt slipping or incorrect type of fan fitted.	Check belt tension and fan type. Check to make certain fan is installed in correct direction.
	e) Valve and/or fuel pump timing incorrect.	Check and reset.
	f) Thermostat stuck in the closed position.	Replace
	g) Cylinder head gasket failure.	Check bow of head and block. Fit new gasket.
Low oil pressure	a) Oil level in sump too low.	Rectify.
	b) Incorrect grade or inferior oil being used.	Change to Approved Grade.
	c) Oil leaking externally from engine.	Rectify.
	d) Pressure gauge or oil warning light switch inaccurate.	Check with master unit.
	e) Oil pump worn or pressure relief valve sticking open.	Replace
	f) Suction pipe to oil pump allowing air to be drawn in.	Rectify.
	g) Worn main or big end bearings.	Overhaul engine.
High oil pressure	a) Incorrect grade of oil being used.	Change to Approved Grade.
	b) Pressure gauge inaccurate.	Check with master unit.
	c) Pressure relief valve sticking closed.	Rectify.
Excessive crankcase pressure	a) Partially choked breather pipe.	Remove and clean.
	b) Worn or sticking piston rings.	Examine.

TROUBLE SHOOTING CHART

SECTION II STEERING GEAR AND PUMP (CHEVROLET – GASOLINE ENGINE)

TROUBLE	POSSIBLE CAUSE	REMEDY
Hissing noise in steering gear	There is some noise in all power steering systems. One of the most common is a hissing sound most evident at standstill parking. There is no relationship between this noise and performance of the steering. "Hiss" may be expected when steering wheel is at end of travel or when slowly turning at standstill.	Slight "hiss" is normal and in no way affects steering. Do not replace valve unless "hiss" is extremely objectionable. A replacement valve will also exhibit slight noise and is not always a cure for the objection. Investigate clearance around flexible coupling rivets. Be sure steering shaft and gear are aligned so flexible coupling rotates in a flat plane and is not distorted as shaft rotates. Any metal-to-metal contacts through flexible coupling will transmit valve "hiss" through the steering column.
Rattle or chuckle noise in steering gear	Gear loose on frame.	Check gear-to-frame mounting screws. Tighten mounting screws.
	Steering linkage looseness.	Check linkage pivot points for wear. Replace if necessary.
	Pressure hose touching other parts of vehicle.	Adjust hose position. Do not bend tubing by hand.
	Loose pitman shaft over center adjustment.	Adjust to specifications.
Belt squeal (particularly noticeable at full wheel travel and standstill parking)	Loose belt.	Adjust belt tension to specification.
Growl noise in steering pump	Excessive back pressure in hoses or steering gear caused by restriction.	Locate restriction and correct. Replace part if necessary.
Groan noise in steering pump	Low oil level.	Fill reservoir to proper level.
	Air in the oil. Poor pressure hose connection.	Tighten connector to specified torque. Bleed system by operating steering from right to left—full turn.
Rattle or knock noise in steering pump	Loose pump pulley nut.	Tighten nut to specified torque.
Momentary increase in effort when turning wheel fast to right or left	Low oil level in pump.	Add power steering fluid as required.
	Pump belt slipping.	Tighten or replace belt.
	High internal leakage.	Check pump pressure.
Hard steering or lack of assist	Loose pump belt.	Adjust belt tension to specification.
	Low oil level in reservoir. NOTE: Low oil level will also result in excessive pump noise.	Fill to proper level. If excessively low, check all lines and joints for evidence of external leakage. Tighten loose connectors to 30 ft-lb (41 N·m).
	Steering gear to column misalignment.	Align steering column.
	Lower coupling flange rubbing against steering gear adjuster plug.	Loosen pinch bolt and assemble properly.
	Tires not properly inflated.	Inflate to recommended pressure.
Foaming milky power steering fluid, low fluid level and possible low pressure.	Air in the fluid, and loss of fluid due to internal pump leakage causing overflow.	Check for leak and correct. Bleed system. Extremely cold temperatures will cause system aeration should the oil level be low. If oil level is correct and pump still foams, remove pump from vehicle and separate reservoir from housing. Check Welch plug and housing for cracks. If plug is loose or housing is cracked, replace housing.

SECTION III – PARKMASTER FRAME AND MOWER

Mowers cannot be raised or lowered.	Insufficient hydraulic oil supply.	Check level in reservoir.
	Worn hydraulic pump.	Rebuild or replace pump.
	Defective seal on hydraulic cylinder piston.	Replace defective seal.
Mowers do not follow terrain	Lack of downward travel.	Fully extend all hydraulic cylinders.
One mower drive wheel skids.	Both gear trains not engaged on mower.	Engage both gear trains.
Tractor rear wheels hit #2 and #3 cutting units.	Mowers incorrectly installed on frame.	See installation instructions and photos, page 12.

PRODUCT CHANGES

In an effort to make improvements available to TORO owners as quickly as possible, minor changes are incorporated into Toro's products from time to time that do not become immediately shown in the Operators Manual. If such a change apparently has been made in your unit, which is not reflected in your manual, see your TORO Distributor for information.

IDENTIFICATION AND ORDERING

Model and Serial Numbers:

The Parkmaster Tractor has two identification numbers: a model number and a serial number. The two numbers are stamped on a decal which is located on the dash panel, Fig. 16, page 18. In any correspondence concerning the General Tractor or Parkmaster supply model and serial numbers to assure that correct information and replacement parts are obtained.

To order replacement parts from an Authorized TORO Distributor, supply the following information:

1. Model and serial number of the Tractor.
2. Part number, description, and quantity of part(s) desired.

NOTE: Do not order by reference number if a parts catalog is being used; use the PART NUMBER.

The Toro Promise

A ONE YEAR LIMITED WARRANTY ON COMMERCIAL PRODUCTS

The Toro Company promises to repair your TORO Product if defective in materials or workmanship. The following time periods from the date of purchase apply:

Commercial Products 1 Year

The costs of parts and labor are included, but the customer pays the transportation costs on walk rotary mowers, trimmers and blowers.

If you feel your TORO product is defective and wish to rely on The Toro Promise, the following procedure is recommended:

1. Contact your Authorized TORO Distributor or Commercial Dealer (the Yellow Pages of your telephone directory is a good reference source).
2. The TORO Distributor or Commercial Dealer will advise you on the arrangements that can be made to inspect and repair your product.
3. The TORO Distributor or Commercial Dealer will inspect the product and advise you whether the product is defective and, if so, make all repairs necessary to correct the defect without an extra charge to you.

If for any reason you are dissatisfied with the distributor's analysis of the defect or the service performed, you may contact us.

Write:

TORO Commercial Products Service Department
8111 Lyndale Avenue South
Minneapolis, Minnesota 55420

The above remedy of product defects through repair by an Authorized TORO Distributor or Commercial Dealer is the purchaser's sole remedy for any defect.

THERE IS NO OTHER EXPRESS WARRANTY. ALL IMPLIED WARRANTIES OF MERCHANTABILITY AND FITNESS FOR USE ARE LIMITED TO THE DURATION OF THE EXPRESS WARRANTY.

Some states do not allow limitations on how long an implied warranty lasts, so the above limitation may not apply to you.

This Warranty applies only to parts or components which are defective and does not cover repairs necessary due to normal wear, misuse, accidents, or lack of proper maintenance. Regular, routine maintenance of the unit to keep it in proper condition is the responsibility of the owner.

All warranty repairs reimbursable under the Toro Promise must be performed by an Authorized TORO Commercial Dealer or Distributor using Toro approved replacement parts.

Repairs or attempted repairs by anyone other than an Authorized TORO Distributor or Commercial Dealer are not reimbursable under the Toro Promise. In addition, these unauthorized repair attempts may result in additional malfunctions, the correction of which is not covered by warranty.

THE TORO COMPANY IS NOT LIABLE FOR INDIRECT, INCIDENTAL OR CONSEQUENTIAL DAMAGES IN CONNECTION WITH THE USE OF THE PRODUCT INCLUDING ANY COST OR EXPENSE OF PROVIDING SUBSTITUTE EQUIPMENT OR SERVICE DURING PERIODS OF MALFUNCTION OR NON-USE.

Some states do not allow the exclusion or limitation of incidental or consequential damages, so the above limitation or exclusion may not apply to you.

This warranty gives you specific legal rights, and you may also have other rights which vary from state to state.