

MODEL NO. 03700 - 00001 & UP
MODEL NO. 03701 - 00001 & UP

OPERATOR'S
MANUAL

REELMASTER 450D TRACTION UNIT

To understand this product, and for safety and optimum performance, read this manual before starting the engine. Pay special attention to **SAFETY INSTRUCTIONS** highlighted by this symbol.



It means **CAUTION**, **WARNING** or **DANGER** - personal safety instruction. Failure to comply with the instruction may result in personal injury.



The REELMASTER 450 D conforms to the American National Standards Institute's safety standards for riding mowers when rear tires are filled with calcium chloride and two rear wheel weight kits (Part No. 11-0440) are installed.



FOREWORD

This operator's manual has instructions on safety, proper set-up and operation, adjustments and maintenance. Therefore, anyone involved with the product, including the operator, should read and understand this manual. Major sections are:

- Safety Instructions
- Specifications
- Before Operating
- Know Your Controls
- Operating Instructions
- Maintenance
- Electrical Schematic

This manual emphasizes safety, mechanical and general product information. DANGER, WARNING and CAUTION identify safety messages. Whenever the triangular safety alert symbol appears, understand the safety message that follows. For complete safety instructions, read pages 3 – 7. IMPORTANT highlights special mechanical information and NOTE emphasizes general product information worthy of special attention.

MODEL AND SERIAL NUMBER

The model and serial number is on a plate that is mounted on the frame, just ahead of the right front wheel. Use model and serial number in all correspondence and when ordering parts.



Model/Serial Number Plate

OPTIONAL SPARK ARRESTER

In some places a spark arrester muffler must be used because of local, state or federal regulations. The spark arrester available from your local Toro Distributor is approved by the United States Department of Agriculture and the United States Forest Service. When the mower is used or operated on any California forest, brush or grass covered land, a properly operating spark arrester must be attached to the muffler. The operator is violating state law, Section 442 Public Resources Code if a spark arrester is not used.

Whenever you have questions or need service, contact your local authorized Toro Distributor. In addition to having a complete line of accessories and professional turf care service technicians, the distributor has a complete line of genuine TORO replacement parts to keep your machine operating properly. Keep your TORO all TORO. Buy genuine TORO parts and accessories.

SERVICE MANUAL

A Service Manual is available for the Reelmaster 450-D. This publication provides information for troubleshooting, adjusting, testing and repair of major systems and components on the machine. To order this publication, contact your authorized Toro Distributor. Ask for Form 89-723-ST, Reelmaster 450-D Service Manual.

TABLE OF CONTENTS

	Page		Page
SAFETY INSTRUCTIONS	3	Service Interval Chart	20
SAFETY AND INSTRUCTION DECALS	5	Lubrication	21
SPECIFICATIONS	7	Air Cleaner	21
BEFORE OPERATING		Engine and Oil Filter	22
Check Engine Oil	8	Fuel System	23
Check Cooling System	9	Engine Cooling System	23
Fill Fuel Tank	9	Alternator Belt	24
Check Hydraulic System	10	Cylinder Head Bolts	24
Check Reel to Bedknife Contact	10	Engine Valve Clearance	24
Check Tire Pressure	10	Battery Care	24
Rear Ballast	10	Adjusting Hand Brake & Traction Switches	25
KNOW YOUR CONTROLS	10	Adding Hydraulic Oil	25
OPERATING INSTRUCTIONS		Draining Water From Hydraulic Reservoir	26
Starting and Stopping	13	Changing Hydraulic Oil	26
Priming Fuel System	14	Replacing Hydraulic Filter	26
Checking Warning Indicator Lights	14	Replacing Hydraulic System Breather	27
Checking Interlock System	15	Checking Hydraulic Lines and Hoses	27
Traction Pedal Response	15	Hydraulic System Test Ports	27
Pushing or Towing Traction Unit	16	Rear Wheel Toe-In	28
Operating Characteristics	17	Checking Planetary Gear Drive	28
Cutting Charts	19	OPTIONAL EQUIPMENT	29
MAINTENANCE		ELECTRICAL SCHEMATIC	30
		NOTES	31
		THE TORO PROMISE	32



SAFETY INSTRUCTIONS

Improper use or maintenance by the operator or owner of the machine can result in injury. Reduce the potential for any injury by complying with the following safety instructions.

BEFORE OPERATING

1. Read and understand the contents of the traction unit and cutting unit operator's manuals before operating the machine. To get replacement manuals, send complete model and serial number to: The Toro Company, 8111 Lyndale Avenue South, Minneapolis, MN 55420.
2. Never allow children to operate the machine or adults to operate it without proper instruction.
3. Become familiar with the controls and know how to stop the machine and engine quickly.
4. Keep all shields, safety devices and decals in place. If a shield, safety device or decal is defective or damaged, repair or replace it before operating the machine.
5. Always wear substantial shoes. Do not operate machine while wearing sandals, tennis shoes, sneakers or when barefoot. Do not wear loose fitting clothing that could get caught in moving parts and possibly cause personal injury.

6. Wearing safety glasses, safety shoes, long pants and a helmet is advisable and required by some local ordinances and insurance regulations.
7. Make sure the work area is clear of objects which might be picked up and thrown by the reels.
8. Do not carry passengers on the machine. Keep everyone, especially children and pets, away from the areas of operation.
9. Since diesel fuel is highly flammable, handle it carefully:
 - A. Use an approved fuel container.
 - B. Do not remove fuel tank cap while engine is hot or running.
 - C. Do not smoke while handling fuel.
 - D. Fill fuel tank outdoors and only to within an inch (25 mm) from the top of the tank, not the filler neck. Do not overfill.
 - E. Wipe up any spilled fuel.

WHILE OPERATING

10. Do not run engine in a confined area without adequate ventilation. Exhaust is hazardous and could be deadly.
11. Sit on the seat when starting and operating the machine.



SAFETY INSTRUCTIONS

12. Check interlock switches daily for proper operation. If a switch fails, replace it before operating the machine. The interlock system is for your protection, so do not bypass it. Replace all interlock switches every two years.

13. Before starting the engine each day, test lamps, warning buzzer and signal lights to assure proper operation.

14. Pay attention when using the machine. To prevent loss of control:

A. Mow only in daylight or when there is good artificial light.

B. Watch for holes or other hidden hazards.

C. Be extremely careful when operating close to sand traps, ditches, creeks, steep hillsides or other hazards.

D. Reduce speed when making sharp turns. Avoid sudden stops and starts. Use ground speed limiter lever to set pedal travel so excessive ground speed will be avoided during mowing and transport.

E. Look to the rear to assure no one is behind the machine before backing up.

F. Watch for traffic when near or crossing roads. Always yield the right-of-way.

G. Reduce speed when driving downhill.

15. Keep hands, feet and clothing away from moving parts and the reel.

16. Raise cutting units and latch them securely in transport position before driving from one work area to another.

17. Do not touch engine, muffler or exhaust pipe while engine is running or soon after it is stopped. These areas could be hot enough to cause burns.

18. If cutting unit strikes a solid object or vibrates abnormally, stop immediately, turn engine off, set parking brake and wait for all motion to stop. Inspect for damage. If reel or bedknife is damaged, repair or replace it before operating. Do not attempt to free blocked cutting unit by moving Mow/Backlap lever rapidly between FORWARD and BACKLAP. Damage to hydraulic system may result. Lever should easily return and hold in the STOP position.

19. Before getting off the seat:

A. Move traction pedal to neutral.

B. Set parking brake.

C. Disengage cutting units and wait for reels to stop.

D. Stop engine and remove key from switch.

E. Do not park on slopes unless wheels are chocked or blocked.

20. The optional TORO towbar is for emergency towing only. Use only the special tow bar if it becomes necessary to tow machine. Use trailer for normal transport.

MAINTENANCE

21. Before servicing or making adjustments, stop engine and remove key from the switch.

22. Assure entire machine is properly maintained and in good operating condition. Frequently check all nuts, bolts and screws.

23. Frequently check all hydraulic line connectors and fittings. Assure all hydraulic hoses and lines are in good condition before applying pressure to the system.

24. Keep body and hands away from pin hole leaks or nozzles that eject high pressure hydraulic fluid. Use cardboard or paper to find hydraulic leaks. Hydraulic fluid escaping under pressure can penetrate skin and cause injury. Fluid accidentally injected into the skin must be surgically removed within a few hours by a doctor or gangrene may occur.

25. Before any hydraulic system maintenance, stop engine and lower cutting units to the ground so all pressure is relieved.

26. For major repairs or other assistance, contact your local Toro Distributor.

27. To reduce potential fire hazard, keep engine area free of excessive grease, grass, leaves and dirt. Clean protective screen on back of engine frequently.

28. If engine must be running to perform maintenance or an adjustment, keep hands, feet, clothing and other parts of the body away from cutting units and other moving parts. Keep everyone away.

29. Do not overspeed the engine by changing governor setting. Maximum engine speed is 2500 rpm + or - 100 rpm. To assure safety and accuracy, have an Authorized Toro Distributor check maximum engine speed.

30. Shut engine off before checking or adding oil to the crankcase.

31. Disconnect battery before servicing the machine. If battery voltage is required for troubleshooting or test procedures, temporarily connect the battery.

32. Toro recommends that two people be used to backlap reels. Each person has specific duties and you must communicate with one another.



SAFETY INSTRUCTIONS

33. For optimum performance and safety, use genuine Toro replacement parts and accessories. Replacement parts and accessories made by other

manufacturers could be dangerous and may void the product warranty of The Toro Company.



SAFETY AND INSTRUCTION DECALS

The following safety and instruction decals are installed on the traction unit. If any become damaged, replace them. Decals are listed in your Parts Catalog. Order replacements from your Authorized TORO Distributor.

! DANGER

UNDER NO CIRCUMSTANCES USE A SHORT HANDLED PAINT BRUSH. SEE OPERATOR'S MANUAL FOR COMPLETE INSTRUCTIONS.

! WARNING

DURING BACKLAP OPERATION REELS ARE UNDER POWER. CONTACT WITH REELS CAN RESULT IN PERSONAL INJURY.

1. ENGAGE PARKING BRAKE.
2. HAVE ASSISTANT START ENGINE, SET THROTTLE TO MIN. IDLE SPEED SETTING AND WHEN INSTRUCTED BY MECHANIC, ENGAGE REELS IN BACKLAP MODE.
3. USING PAINT BRUSH ATTACHED TO HANDLE PROVIDED, APPLY LAPPING COMPOUND TO REELS.

! CAUTION

FAILURE TO COMPLY WITH THE FOLLOWING SAFETY INSTRUCTIONS MAY RESULT IN PERSONAL INJURY.

1. KEEP PEOPLE AND PETS A SAFE DISTANCE AWAY FROM MACHINE.
2. KEEP ALL GUARDS IN PLACE.
3. BEFORE LEAVING OPERATOR'S POSITION:
 - A. MOVE TRANSMISSION PEDAL TO NEUTRAL
 - B. SET PARKING BRAKE.
 - C. DISENGAGE CUTTING UNIT AND ASSURE REELS ARE NO LONGER SPINNING.
 - D. SHUT OFF ENGINE.
 - E. REMOVE IGNITION KEY.
4. WAIT FOR ALL MOVEMENT TO STOP BEFORE SERVICING MACHINE.
5. STOP ENGINE BEFORE ADDING FUEL OR LIFTING HOOD.
6. CHECK PERFORMANCE OF ALL INTERLOCK SWITCHES DAILY. SEE OPERATOR'S MANUAL FOR INSTRUCTION. DO NOT DEFEAT INTERLOCK SYSTEM. IT IS FOR YOUR PROTECTION.



READ AND UNDERSTAND OPERATOR'S MANUAL BEFORE OPERATING THIS MACHINE. REPLACEMENT MANUAL AVAILABLE BY SENDING COMPLETE MODEL NUMBER TO: THE TORO COMPANY, 8111 LYNDALE AVE., MINNEAPOLIS, MINN. 55420.

58-6540

ON PANEL IN FRONT OF OPERATOR'S SEAT (Part No. 58-6540)

HYDRAULIC OIL LEVEL

FILL TO CENTER OF GLASS OR HIGHER WITH APPROVED HYDRAULIC OIL.



SEE OPERATOR'S MANUAL FOR LIST OF APPROVED OILS. DO NOT USE ENGINE OIL.



HYDRAULIC OIL ONLY
USE MOBIL DTE 26 OR SHELL TELLUS 68

BELOW OPERATOR'S SEAT (Part No. 59-7290)

UNDER SEAT NEAR OIL FILL CAP (Part No. 58-6530)

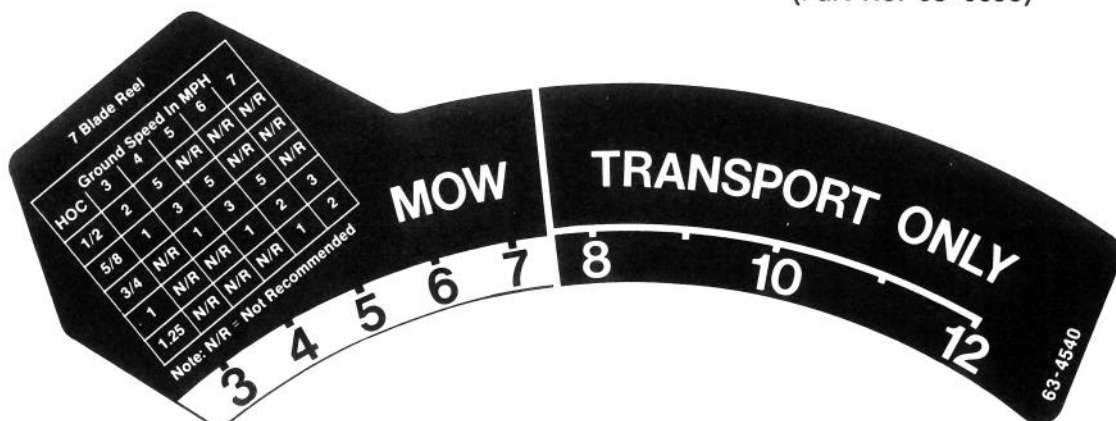

NEXT TO TRACTION PEDAL ON STEERING CONSOLE (Part No. 63-4540, Model 03700)
(Part No. 63-4530, Model 03701)

SAFETY AND INSTRUCTION DECALS



ON STEERING CONSOLE (Part No. 59-7210)

IMPORTANT: for proper performance engine must be at full speed while mowing.

ON STEERING CONSOLE (Part No. 60-4080)



NEAR FUEL TANK FILL CAP (Part No. 49-2280)



ON RADIATOR CAP (Part No. 59-8440)



NEAR RADIATOR FILL CAP (Part No. 58-6940)



ON FAN SHROUD (Part No. 67-1650)



ON FRAME ABOVE REAR WHEELS (Part No. 58-5910)

HYDRAULIC TEST PORTS



NEAR TEST PORTS (Part No. 58-6680)

IMPORTANT
DO NOT ALLOW LIFT LEVERS TO "SNAP BACK" WHEN LOWERING CUTTING UNITS: UNITS MAY NOT LOWER COMPLETELY.



NEXT TO LIFT LEVERS (Part No. 62-6290)



IMPORTANT
THIS UNIT COMPLIES WITH ANSI B7 1.4-1984 WHEN EQUIPPED WITH REAR BALLAST PER OPERATOR'S MANUAL.

ON FRAME ABOVE RIGHT REAR WHEEL (Part No. 62-6280)



SAFETY AND INSTRUCTION DECALS



ON FRONT CARRIER & TOW BAR
(Part No. 63-4380)



THIS ARM CAN SPRING UPWARD!
SEE OPERATORS MANUAL FOR DISASSEMBLY PROCEDURE.

ON LIFT ARMS (Part No. 61-3610)

FRONT CUTTING REEL

TRANSPORT LATCHING



RELEASE

LATCH

NEAR FRONT CUTTING UNIT RELEASE LEVER
(Part No.59-7960)



ON CUTTING UNIT (Part No. 76-8760)

SPECIFICATIONS

Engine: Mitsubishi model 4DQ5, four-cycle, four cylinder, 127 cu-in. displacement, water cooled diesel engine. Rated 40 hp @ 2300 rpm, 21:1 compression ratio. Low idle - 1200 rpm, high idle - 2500 rpm. Injection Timing - 20° BTDC. Oil capacity is 6.9 qt (6.5 L) with filter.

Cooling System: Capacity is 2.6 gal. (10 L) of 50/50 mixture of ethylene glycol anti-freeze.

Fuel System: Capacity is 17 gal. (64 L) of #2 diesel fuel.

Hydraulic System: Reservoir capacity is 15 gal. (58 L) and total system capacity is 18.2 gal. (69 L). Replaceable breather element. Replaceable spin-on filter element.

Traction System: Ground speed is 0-13 mph (0-21 km/h) Model 03700, 0-16 mph (0-25 km/h) Model 03701.

Cutting Unit Drive System: Adjustable reel speed to match clip to ground speed. Backlap reel speed is 385 rpm.

Seat: Adjusts 6 in. (15.2 cm) forward and backward. Adjustable backrest and three-positions for operator weight. Integral seat switch in bottom seat cushion.

Diagnostic System: Test ports for: traction system, cutting unit drive system, lift/counterbalance, lift/relief, steering circuits and charge pressure.

Steering System: Automotive type, full power.

Brakes: Hand brake automatically locks traction linkage in neutral. With traction motor wheel locks engaged, twin disc brakes provide positive, emergency braking.

Electrical System: 12 volt, 66 amp hour (DIN) battery and 35 amp alternator. Negative ground.

Interlock System: Designed to stop engine if operator gets off seat while cutting unit drive lever is either in forward or reverse. Prevents engine from starting unless parking brake is engaged, traction pedal is in neutral and cutting units are disengaged. Low hydraulic oil level and high engine temperature protection systems stop engine from running.

Warning Systems:

- Water in fuel
- Hydraulic oil filter
- Engine coolant temperature
- Engine oil pressure
- Hydraulic oil temperature
- Hydraulic oil pressure
- Hydraulic oil level

SPECIFICATIONS

General Specifications (approx.):

Width-of-Cut :

5 Cutting Units	137 in.	(348 cm)
4 Cutting Units	110 in.	(279 cm)
3 Cutting Units	83 in.	(211 cm)
1 Cutting Unit	29 1/2 in.	(75 cm)

Overall Width:

Cutting Units Raised	91 1/2 in.	(232 cm)
Cutting Units Down	147 in.	(373 cm)

Overall Length: 110 in. (282 cm)

Height: 55 1/2 in. (141 cm)

Ground Clearance: approx. 7 in. (17.8 cm)

Recommended Height-of-Cut:

5 Blade Cutting Unit:	1 – 3 in.	(25 – 76 mm)
7 Blade Cutting Unit:	3/8 – 1 3/4 in.	(9.5 – 45 mm)
11 Blade Cutting Unit:	3/8 – 3/4 in.	(9.5 – 19 mm)

Wheel Tread: 53 in. (135 cm)

Wheel Base: 57 in. (145 cm)

Operating Circle: 60 in. (152 cm)

Dry Weight: 3786 lbs. (1717 kg)

Reel Speed: 800 – 1200 rpm, Model 03700
470 – 950 rpm, Model 03701

Clip (variable to match conditions):

5 Blade Cutting Unit:	.176 in. per mph (.352 in. at 2 mph – 1.32 in. at 7.5 mph)
7 Blade Cutting Unit:	.126 in. per mph (.252 in. at 2 mph – .945 in. at 7.5 mph)
11 Blade Cutting Unit:	.080 in. per mph (.16 in. at 2 mph – .600 in. at 7.5 mph)

Fluids:

Engine Oil:	SAE 10W30 SF, CD
Diesel Fuel:	#2
Cooling System:	50/50 Water & Anti-Freeze
Hydraulic Oils (Interchangeable):	Mobil DTE 26/Shell Tellus 68 Equivalent*
*Equivalent Hydraulic Oils (Interchangeable)	
Amoco	Rykon Oil #68
Conoco	Super Hydraulic Oil 68
Exxon	Nuto H 68
Kendall	Kenoil R & O AW 68
Pennzoil	Penreco 68
Phillips	Magnus A 68
Standard	Energol HLP 68
Sun	Sunvis 831 WR
Union	Unax AW 68

BEFORE OPERATING

CHECK ENGINE OIL – DAILY

1. Park machine on a level surface. Release engine cover latches (Fig. 1).

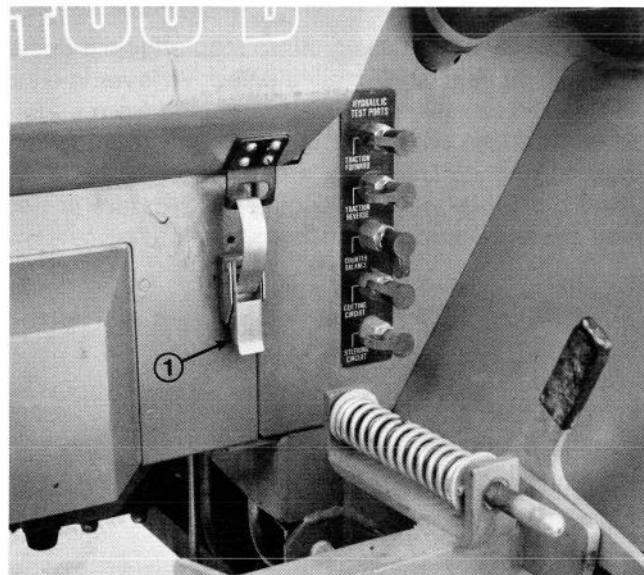

Figure 1
1. Engine Cover Latch

2. Open engine cover and hold it upright with support rod. (Fig. 2).

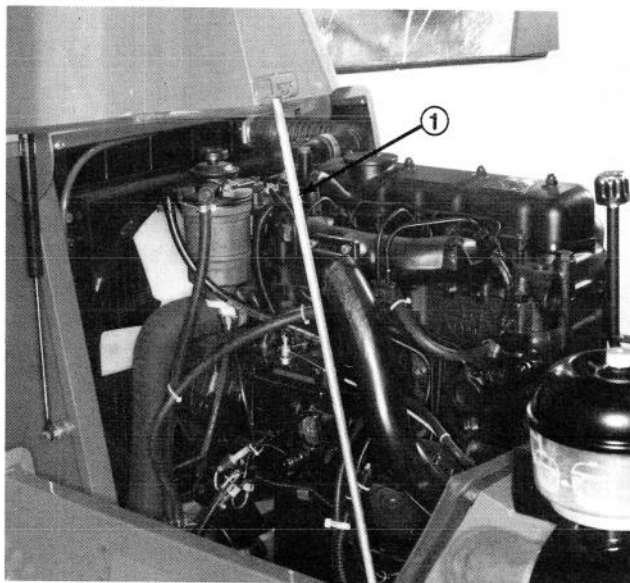

Figure 2
1. Support Rod

3. Remove dipstick, wipe clean and reinstall dipstick into tube and pull it out again: Oil level should be up to FULL mark (Fig. 3).

BEFORE OPERATING

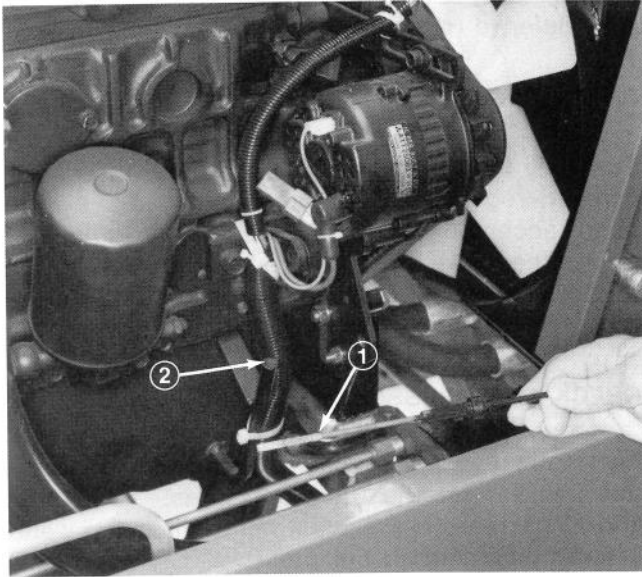

Figure 3

1. Dipstick
2. Dipstick Tube

4. If oil is below FULL mark, remove fill cap (Fig. 4) and add SAE 10W-30 oil until level reaches FULL mark. DO NOT OVERFILL. Crankcase capacity is 6.9 qt. (6.5 L) with filter.



Figure 4

1. Oil Fill Cap
2. Oil Fill Opening

5. Install oil fill cap and dipstick.
6. Close engine cover and secure with the latches.

CHECK COOLING SYSTEM - DAILY

Capacity of system is 2.6 gal. (10 L).

1. Remove radiator cap (Fig. 5). Coolant should be one inch from bottom of fill hole.
2. If coolant is low, add a 50/50 mixture of water and ethylene glycol anti-freeze. DO NOT USE WATER ONLY OR ALCOHOL/METHANOL BASE COOLANTS.
3. Install radiator cap.



CAUTION

The best time to check coolant level is before the engine is started each day because it is not pressurized. When the engine is hot, pressurized coolant can escape and cause burns when the radiator cap is removed. Remove radiator cap slowly and carefully if engine coolant is hot.

FILL FUEL TANK

1. Remove fuel tank cap (Fig. 5).

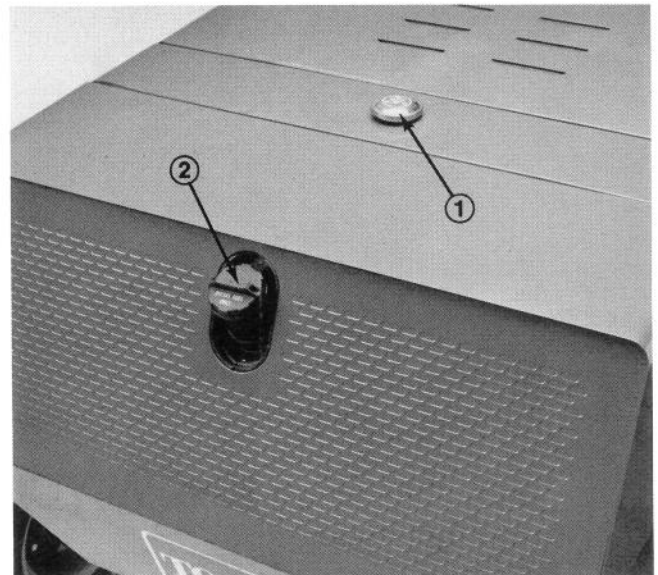

Figure 5

1. Radiator Cap
2. Fuel Tank Cap

2. Fill tank to about one inch (25 mm) below bottom of filler neck with No. 2 diesel fuel. Then install cap.

BEFORE OPERATING



DANGER

Because diesel fuel is flammable, use caution when storing or handling it. Do not smoke while filling the fuel tank. Do not fill fuel tank while engine is running, hot, or when machine is in an enclosed area. Always fill fuel tank outside and wipe up any spilled diesel fuel before starting the engine. Store fuel in a clean, safety-approved container and keep cap in place. Use diesel fuel for the engine only; not for any other purpose.

CHECK HYDRAULIC SYSTEM – DAILY

1. Look into sight glass (Fig. 6). Oil level should be even with arrows when checking warm oil. Oil will be 1/4 to 1/2 inch below arrows when cold.



Figure 6

1. Sight Glass Arrows

2. If oil level is low, add hydraulic oil to the reservoir. Refer to Hydraulic Oil Specifications (Page 8).

CHECK REEL TO BEDKNIFE CONTACT – DAILY

Each day before operating, check reel to bedknife contact, regardless if quality of cut had previously been acceptable. There must be light contact across the full length of the reel and bedknife (refer to Adjusting Cutting Units in Cutting Unit Manual, Step #1 – Reel to Bedknife Adjustment).

CHECK TIRE PRESSURE – DAILY

For normal mowing conditions and a wide variety of turf grasses, use these tire pressures: 13 psi front and 15 psi rear. However, when turf is either wetter or drier than normal, tire pressure may need to be changed. On hard turf, use high tire pressure (18 psi front and rear). When turf is soft, use low pressure (9 psi front and 12 psi rear).

IMPORTANT: Maintain even pressure in two front tires (ie. 13 psi) and both rear tires (ie 15 psi) to assure excellent quality-of-cut. Do not exceed 10 mph transport speed (for extended periods) when tire pressure is 12 psi or less because tires may be damaged. Maximum transport speed can be used when front tire pressure is 13 psi or more.

REAR BALLAST

This unit complies with the ANSI B71.4–1984 Standard when rear tires are filled with calcium chloride and 2 rear wheel weight kits (Part no.11–0440) are installed.

IMPORTANT: If a puncture occurs in a tire with calcium chloride, remove unit from turf area as quickly as possible. To prevent possible damage to turf, immediately soak affected area with water.

KNOW YOUR CONTROLS

Seat (Fig. 7) – Arm rests pivot up and down. Seat adjusting lever allows 5.9 inch (15 cm) fore and aft adjustment in 19/32 inch (15 mm) increments. Backrest knob adjusts backrest angle from 5–20 degrees. Suspension lever adjusts seat to the operator's weight. Use up position for light weight operators, center position for medium weight operators and down for heavier weight operators. Backrest cushion and bottom seat cushion are removable.



CAUTION

TO ASSURE INTERLOCK SWITCH OPERATES PROPERLY, SEAT SUSPENSION MUST BE SET FOR THE WEIGHT OF EACH OPERATOR. IF SUSPENSION IS NOT SET CORRECTLY, THE ENGINE WILL RUN INTERMITTENTLY AND TEND TO STALL. TO CORRECT THIS, SET SUSPENSION LIGHTER.

KNOW YOUR CONTROLS

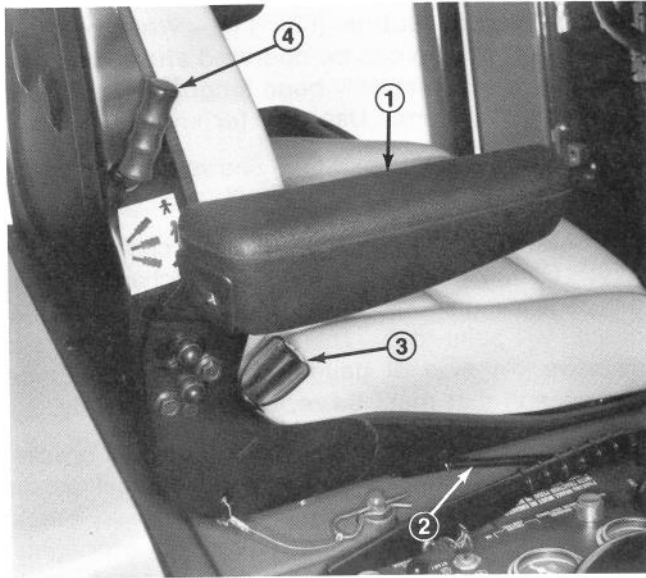

Figure 7

1. Arm Rest
2. Seat Adjusting Lever
3. Backrest Knob
4. Suspension Lever

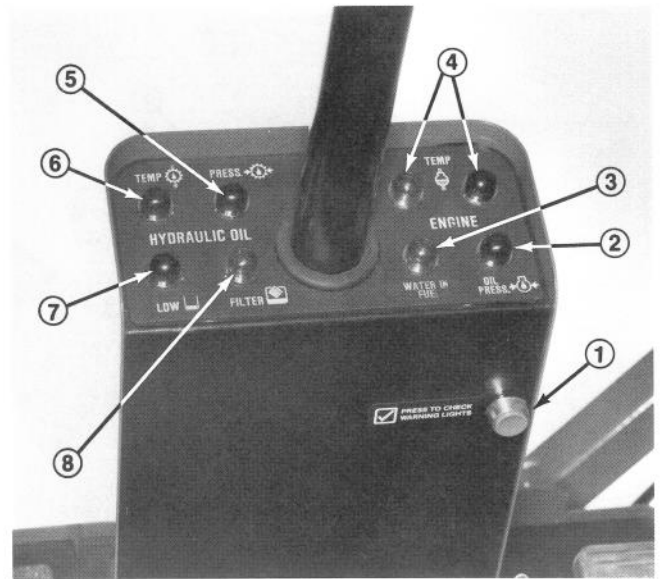

Figure 8

1. Warning Light Check Switch
2. Oil Pressure Light
3. Water in Fuel Light
4. Engine Coolant Temperature Lights
5. Hydraulic Oil Pressure Light
6. Hydraulic Oil Temperature Light
7. Hydraulic Low Oil Light
8. Hydraulic Oil Filter Light

Warning Light Check Switch (Fig. 8) – Before operating, press switch button. All lights on the steering tower should illuminate. Any light that does not come on indicates an electrical malfunction that should be repaired immediately.

Hydraulic and Engine Indicator Lights (Fig. 8) – If these lights come on, stop machine and make repairs immediately.

Engine Oil Pressure Light (Fig. 8) – Indicates dangerously low engine oil pressure.

Water In Fuel Light (Fig. 8) – Indicates excess water in fuel system.

Engine Coolant Temperature Lights (Fig. 8) – The amber light illuminates when coolant temperature exceeds 203° F (95° C). The red light illuminates and the engine stops when temperature of coolant exceeds 230° F (110° C).

Hydraulic Oil Pressure Light (Fig. 8) – Indicates low hydraulic oil pressure.

Hydraulic Oil Temperature Light (Fig. 8) – Indicates hydraulic oil temperature is too high.

Hydraulic Low Oil Light (Fig. 8) – Indicates low hydraulic oil level.

Hydraulic Filter Light (Fig. 8) – Indicates clogged hydraulic filter.

Horn – In center of steering wheel. Operates only when key switch is in ON.

Traction Pedal (Fig. 9) – Controls forward and reverse operation. Depress top of pedal to move forward and bottom to move backward. Ground speed depends on how far pedal is depressed. For no load, maximum ground speed, fully depress pedal while throttle is in FAST. Maximum, forward speed is approximately 13 mph (21 km/hr). For maximum power underload or when going uphill, keep engine rpm high by having throttle in FAST and traction pedal held stationary against ground speed limiter. If engine rpm begins to decrease due to load, gradually reduce traction pedal pressure until engine speed is increased.

To stop, reduce foot pressure on traction pedal and allow it to return to center position. On extreme downhill slopes, apply pressure to REVERSE side of pedal, or operate with heel on REVERSE and toe on FORWARD portion of pedal.

Ground Speed Limiter (Fig. 9) – Controls traction pedal movement. Limiter lever helps control the rate of clip and eliminates sudden speed variations over rough terrain.

IMPORTANT: Cam lever nut (Fig. 9 Inset) can be tightened if limiter stop will not hold traction pedal in desired position.

Transport Latches (Fig. 9 and 10) – Latches secure cutting units in upright position for transport operation. Latch for front cutting units is foot-operated (Fig. 9). Hand-operated latches control the center and outside cutting units (Fig. 10).

KNOW YOUR CONTROLS

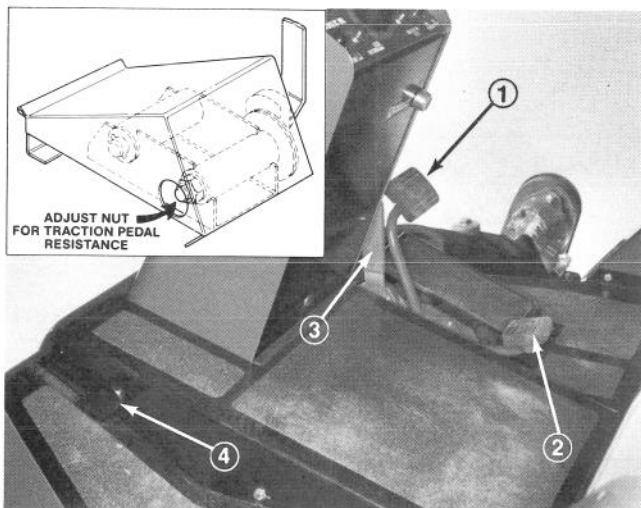

Figure 9

1. Top of Traction Pedal – Forward
2. Bottom of Traction Pedal – Reverse
3. Speed Limiter
4. Transport Latch – Front Cutting Units

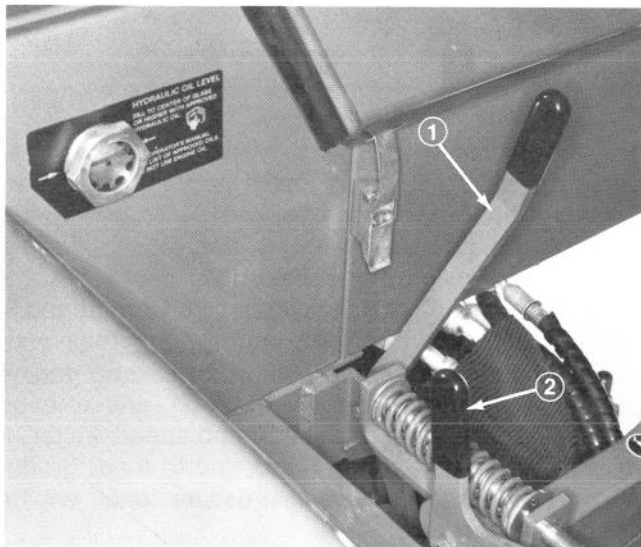

Figure 10

1. Center Cutting Unit Latch
2. Outside Cutting Unit Latch

Cutting Unit Lift Controls (Fig. 11) – The two outside levers raise and lower the two outside cutting units. The center lever raises and lowers the two front and the center cutting units. Engine must be running to lower cutting units. When cutting units are lifted, reels automatically stop. Do not allow levers to snap-back to neutral, or cutting units may not float freely.

Cross Cut Link (Fig. 11) – Used in conjunction with center cutting unit lift lever and Mow/Backlap lever when cross cutting turf.

Coolant Temperature Gauge (Fig. 11) – Shows temperature of coolant in radiator.

Engine Override Button (Fig. 11) – When button is depressed, engine can be operated after it has over heated and automatically been stopped by the electrical safety system. Use only for short intervals.

Fuel Level Gauge (Fig. 11) – Shows amount of fuel in tank.

Ammeter (Fig. 11) – Indicates rate of charge to battery. Gauge usually shows a slight charge unless engine is idling slowly. When battery is fully charged, needle will point to 0. If ammeter needle points to negative (-) side of gauge, there is an electrical malfunction that must be repaired immediately.

Circuit Breakers (Fig. 11) – The main circuit breaker (40 amp) protects the main engine electrical circuits and options, such as headlights. The auxiliary breaker (10 amp) protects wiring for the indicator lights, switches and so forth. Push button to reset breakers.

Hour Meter (Fig. 11) – Shows total hours that machine has been operated.

Note: Lines circling in the small window at left side of gauge indicate hour meter is operating.

Glow Plug Indicator (Fig. 11) – Burns brightly when glow plugs are heated sufficiently.

Glow Plug Switch (Fig. 11) – For cold starts, push and hold switch until indicator glows brightly.

No Charge Light (Fig. 11) – Illuminates when system charging circuit malfunctions.

Key Switch (Fig. 11) – Three positions: OFF, ON and START. Rotate key to START and release key when engine begins running. To stop engine, rotate key to OFF.

Parking Brake Lever (Fig. 11) – Pull lever up to lock brake. To release brake, pull up on lever, press button and lower lever. Brake must be engaged to start engine. Always engage parking brake before getting off seat.

Mow-Backlap Lever (Fig. 11) – Move lever forward to engage cutting units. Move lever to the center to stop the cutting units. To backlap cutting units, lift lever over stop and hold in the rear position.

CAUTION: Do not move lever directly between MOW and BACKLAP positions. Pause briefly in STOP position.

Reel Speed Control (Fig. 11) – Rotate knob clockwise to increase reel speed, counter-clockwise to decrease speed. Use in conjunction with the ground speed limiter to achieve appropriate rate of clip.

Throttle Control (Fig. 11) – Move control forward to increase engine speed, backward to decrease speed.

KNOW YOUR CONTROLS

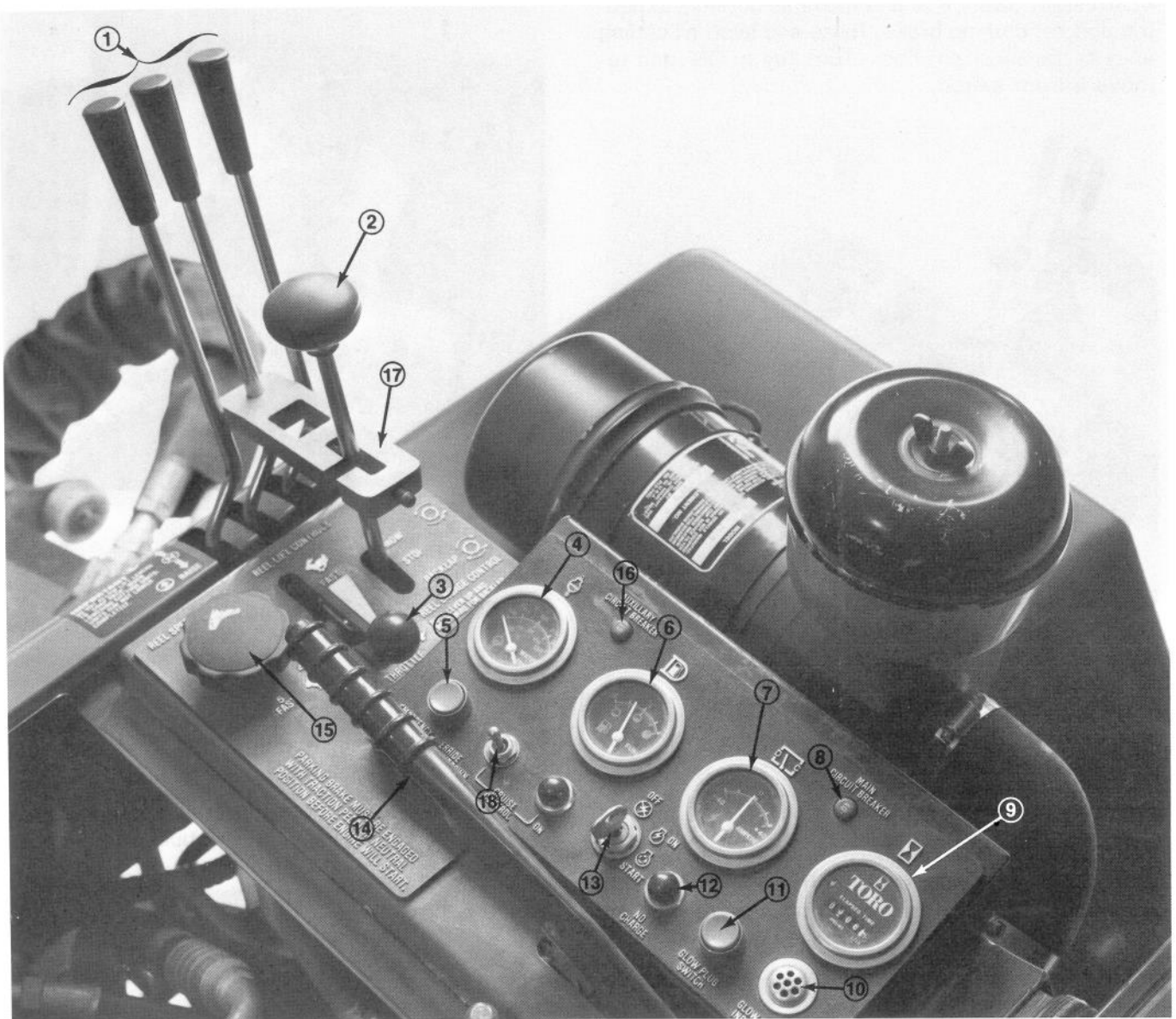

Figure 11

- | | |
|-------------------------------|--|
| 1. Cutting Unit Lift Controls | 10. Glow Plug Indicator |
| 2. Mow/Backlap Lever | 11. Glow Plug Switch |
| 3. Throttle | 12. No Charge Light |
| 4. Coolant Temperature Gauge | 13. Key Switch |
| 5. Engine Override Button | 14. Hand Brake |
| 6. Fuel Level Gauge | 15. Reel Speed Control |
| 7. Ammeter | 16. Auxiliary Circuit Breaker |
| 8. Main Circuit Breaker | 17. Cross Cut Link |
| 9. Hourmeter | 18. Cruise Control Switch and Indicator Light (Optional) |

OPERATING INSTRUCTIONS

STARTING AND STOPPING

1. Sit on the seat, keep foot off traction pedal. Assure parking brake is engaged (Fig. 12). Traction pedal and mow/backlap lever must be in neutral.
2. If engine or air temperature is below 45°–50° F (7°–10° C), press and hold glow plug switch in until indicator burns brightly (Fig. 12). Then release switch and proceed to step 3 to start engine.
3. Move throttle to SLOW and turn ignition key to START (Fig. 12). Release key when engine starts.

OPERATING INSTRUCTIONS

4. To stop, disengage and move all controls to neutral and set parking brake. Raise and latch all cutting units in transport position. Turn key to OFF and remove it from switch.

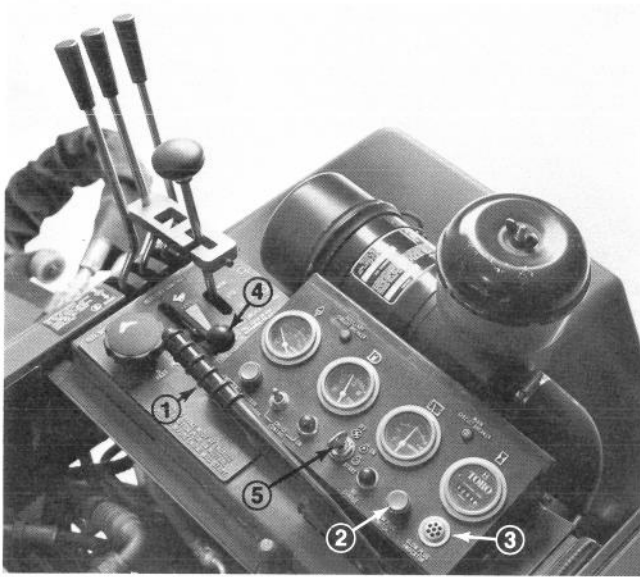

Figure 12

1. Parking Brake
2. Glow Plug Switch
3. Glow Plug Indicator
4. Throttle
5. Ignition Key

PRIMING FUEL SYSTEM

IMPORTANT: The fuel system must be primed when a new engine is started for the first time, if it runs out of fuel or if maintenance is performed on the fuel system.

1. Raise engine cover and use support rod to hold it open (Fig. 12).
2. Loosen fuel filter bleed plug one turn (Fig. 13). Push priming plunger (Fig. 13) until a steady stream of fuel runs out of hole in plug. When fuel stops foaming, tighten plug during the downstroke of the priming plunger. Wipe up any spilled fuel.

Note: It may be necessary to bleed the air out of the fuel line between the fuel filter and the injection pump. To do this, loosen the fitting on the injection and repeat bleeding procedure.

3. Normally the engine will now start. If engine does not start, loosen each injector fitting at the engine and crank engine until steady stream of fuel runs out of fitting. Tighten fitting when foaming of fuels stops.

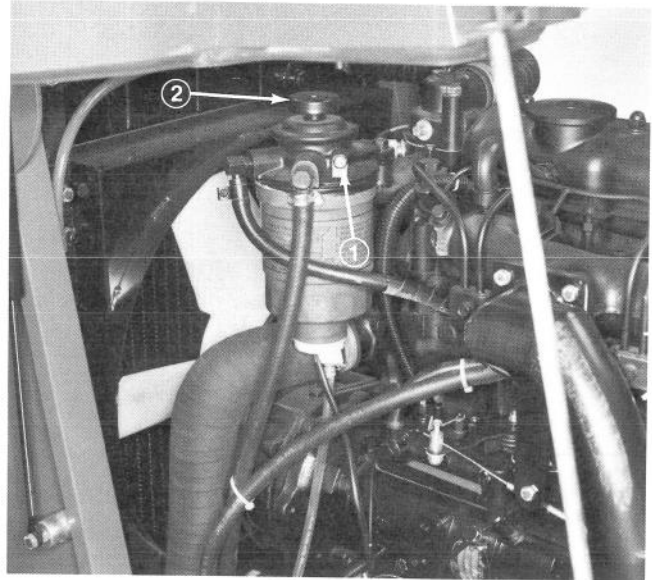

Figure 13

1. Bleed Plug
2. Priming Plunger

CHECKING WARNING INDICATOR LIGHTS

Each day before operating, assure all warning lights are working.

1. Apply parking brake, turn ignition key ON. Push warning indicator light button (Fig. 14). All lights should illuminate and the buzzer sound.
2. If a light is burned out, unscrew appropriate lens (Fig. 14 Inset) and install a new bulb and o-ring.

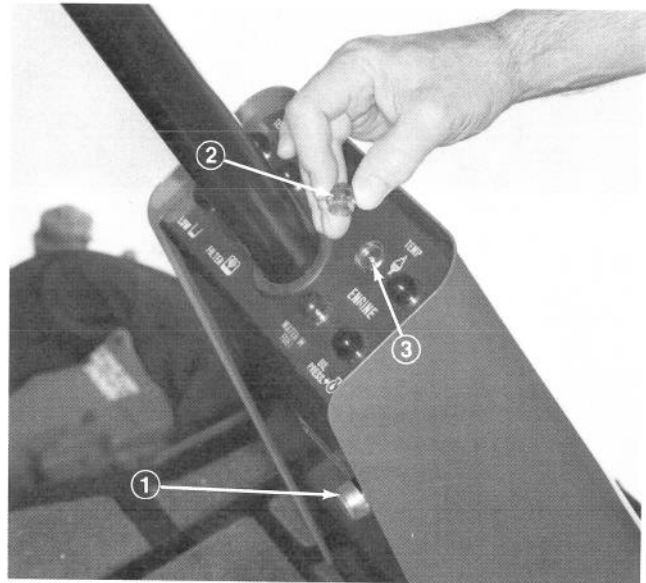

Figure 14

1. Warning Indicator Light Test Button
2. Lens
3. Bulb

OPERATING INSTRUCTIONS

CHECKING INTERLOCK SYSTEM.



CAUTION

THE INTERLOCK SWITCHES ARE FOR THE OPERATOR'S PROTECTION, SO DO NOT DISCONNECT THEM. CHECK OPERATION OF THE SWITCHES DAILY TO ASSURE INTERLOCK SYSTEM IS OPERATING. IF A SWITCH IS DEFECTIVE, REPLACE IT BEFORE OPERATING. REGARDLESS IF SWITCHES ARE OPERATING PROPERLY OR NOT, REPLACE THEM EVERY TWO YEARS TO ASSURE MAXIMUM SAFETY.

1. In a wide open area free of debris and bystanders, lower cutting units to the ground. Stop engine.
2. Sit on the seat and engage parking brake (Fig. 15). Turn key and try to start engine with Mow-Backlap lever (Fig. 15) in both the MOW and BACKLAP positions. If engine cranks, there is a malfunction that must be repaired immediately. If engine does not crank, the cutter drive switch is operating properly.

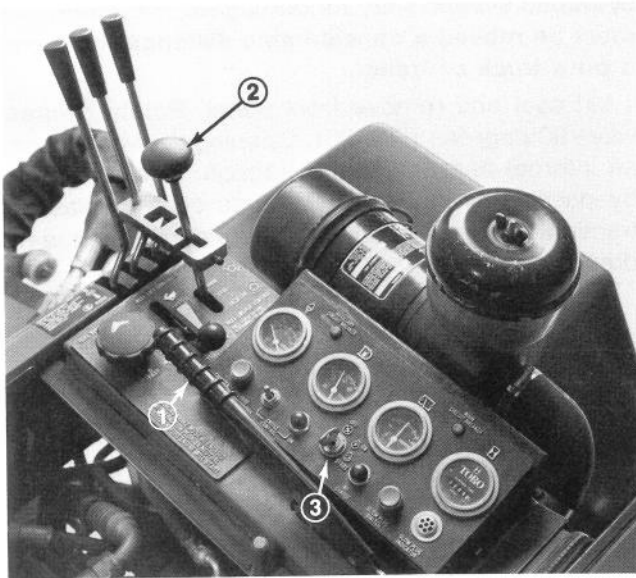

Figure 15

1. Parking Brake
2. Mow/Backlap Lever
3. Key

3. Sit on the seat and disengage the parking brake (Fig. 15). Turn key and try to start engine with Mow-Backlap lever (Fig. 15) in STOP. If engine cranks, there is a malfunction that must be repaired immediately. If engine does not crank, brake switch is operating properly.

4. Engage parking brake (Fig. 15), start engine and lower cutting units. Move Mow-Backlap lever (Fig. 15) to MOW. Raise off the seat; engine should stop within a few seconds, which indicates the interlock system is operating. Also raise off the seat with lever in BACKLAP. Engine should stop, indicating interlock system is operating. If engine does not stop, there is a malfunction that must be repaired immediately.

Note: There is a 1 – 2 second delay between rising off seat and engine shut off.

5. Engage parking brake, move Mow-Backlap lever to NEUTRAL, start engine, disengage hand brake and raise off seat. If engine stops, interlock system is operating. If engine does not stop, there is a malfunction that must be repaired immediately.

TRACTION PEDAL RESPONSE

Normally, traction pedal adjusting knob (Fig. 19) should be screwed in fully. For trimming or quicker pedal response, unscrew the adjusting knob 1 to 2 clicks.

To adjust:

1. Remove retainer clip from seat lock rod (Fig. 16).



Figure 16

1. Retainer Clip
2. Seat Lock Rod

OPERATING INSTRUCTIONS

2. Use seat support rod to hold seat in upright position (Fig. 17).

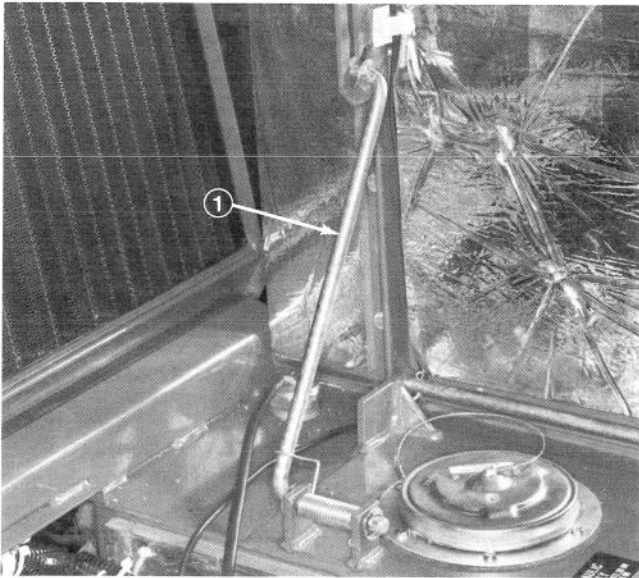

Figure 17
1. Seat Support Rod

3. Lift and remove front panel (Fig. 18).

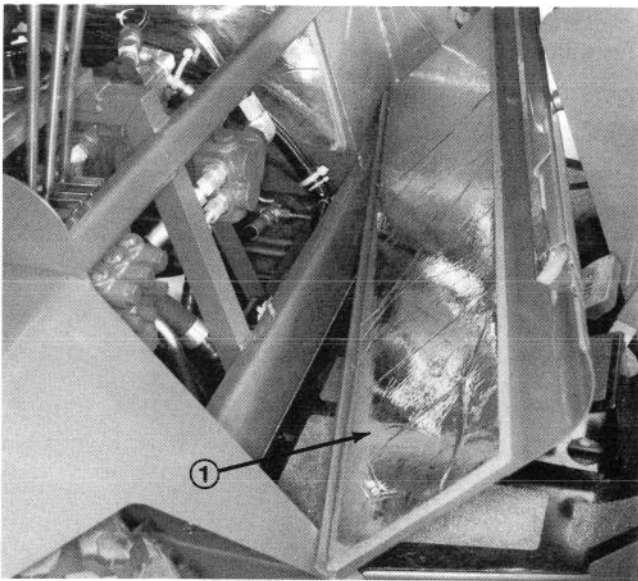

Figure 18
1. Front Panel

4. Rotate traction pedal adjusting knob clockwise to increase pressure (slower response) and counter-clockwise to decrease pressure (quicker response) (Fig. 19).

5. Install front panel over mounting pins (Fig. 18). Lower seat to its normal position and secure with lock pin (Fig. 16).

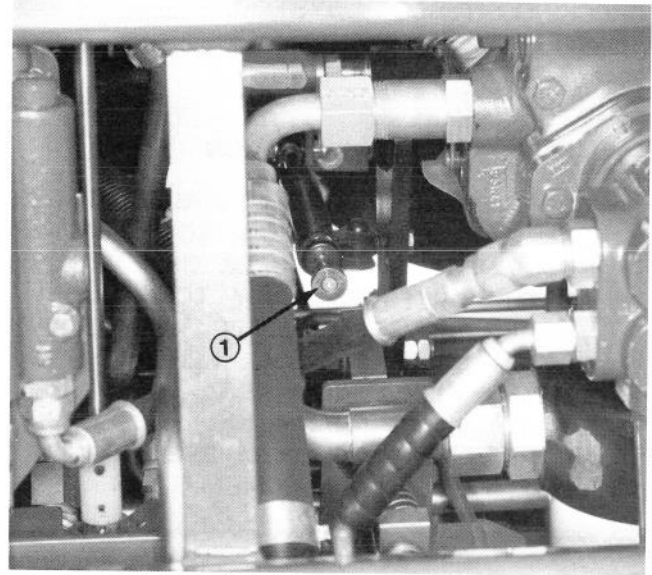

Figure 19
1. Traction Pedal Adjusting Knob

PUSHING OR TOWING TRACTION UNIT

IN AN EMERGENCY, THE TRACTION UNIT CAN BE PUSHED OR TOWED FOR A VERY SHORT DISTANCE, BY USING THE TRACTION PUMP BY-PASS VALVE.

IMPORTANT: Do not push or tow the traction unit faster than 2 to 3 MPH (3 to 5 Km/Hr) because hydraulic system may be damaged. If traction unit must be moved a considerable distance, transport it on a truck or trailer.

1. Lift seat and remove front panel. Rotate by-pass valve 90 degrees (Fig. 20). Opening the valve opens an internal passage in the traction pump, thereby by-passing hydraulic oil. Because oil is by-passed, traction unit can be moved without damaging the hydraulic system.

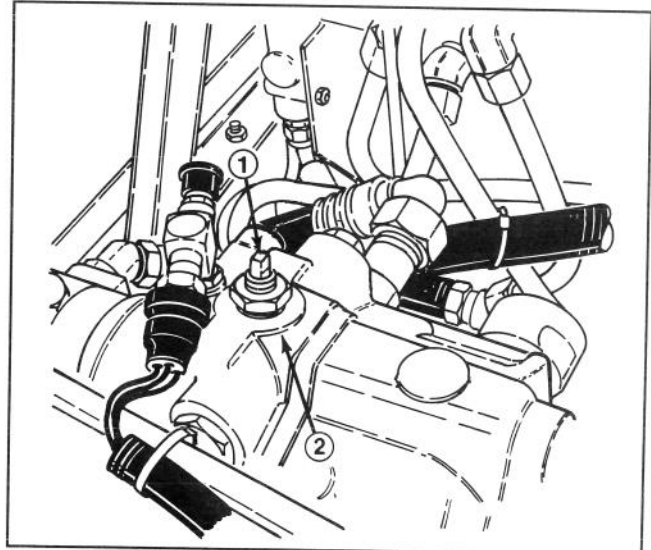

Figure 20
1. By-Pass Valve 2. Traction pump

OPERATING INSTRUCTIONS

IMPORTANT: Make sure that hand brake is engaged before opening the by-pass valve.

2. Before starting engine, close by-pass valve. Do not start engine when valve is open.

IMPORTANT: Running the machine with the by-pass valve open will cause the hydraulic system to overheat.



DANGER

Vehicle will roll with front wheel motors disengaged. Vehicle must be on level surface or wheels must be blocked. There is no effective braking with wheel motors disengaged.

If towing, with front wheel motors disengaged, Tow Bar Assembly, Toro part no. 58-7020, must be used.

OPERATING CHARACTERISTICS

Familiarization – Before mowing grass practice operating in an open area. Start and stop the engine. Operate in forward and reverse. Lower and raise cutting units simultaneously and individually. Engage and disengage reels. Operate with all cutting units down, then with only an individual cutting unit. When you feel familiar with the machine, practice operating around trees and obstacles. Also drive up and down slopes using both mowing and transport speeds.

Warning System – If a warning light comes on during operation, stop the machine immediately and correct the problem before continuing operation. Serious damage could occur if the machine is operated with a malfunction. For short intervals, however, the emergency engine override button (Fig. 11) can be used to operate the engine if it stops because of overheating.

Mowing –When you are at the area to be mowed, release front cutting unit transport latch (Fig. 9), center latch and outside latches (Fig. 21). Lower cutting units, engage the hand brake and stop the engine.

Adjust grass deflectors to horizontal position (Fig. 22).

Note: Adjust grass deflectors so clippings disperse backward; out and away from the cutting units. This will prevent clumps of clippings, especially wet clippings, dropping off the machine or cutting units, which affects the visual appearance of the turf.



Figure 21

1. Outside Cutting Unit Transport Latch

Generally you can adjust the deflectors down slightly in dry grass and up slightly in wet grass.

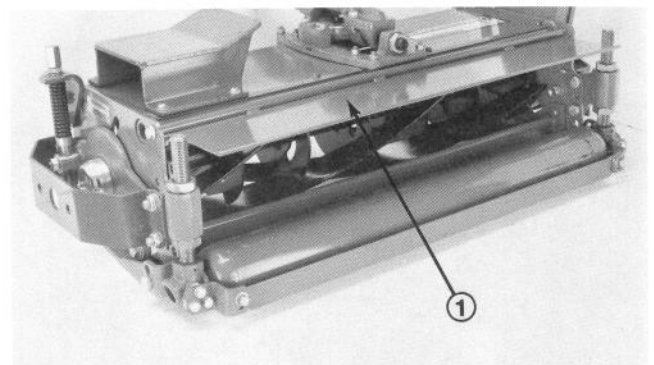

Figure 22

1. Grass Deflector

Match ground speed limiter (Fig. 23) and reel speed control knob (Fig. 24) to desired height-of-cut: refer to Cutting Chart (Fig. 27). Use decal at side of steering column as a guide only.

Cross Cut Link - When engaging / disengaging center lift control lever, cross cut link will simultaneously engage / disengage the mow control lever to eliminate the need for two separate hand operations. If mow control lever does not follow the motion of the lift control lever during operation, adjust set screw(s) as required.

When permanent use of cross cut link is not desired, it can be removed by unscrewing lift control knob and loosening set screw.

To temporarily disconnect cross cut link, stop engine, pull back on lift lever until slot in link is aligned with mow control lever and swing link to the side.

OPERATING INSTRUCTIONS

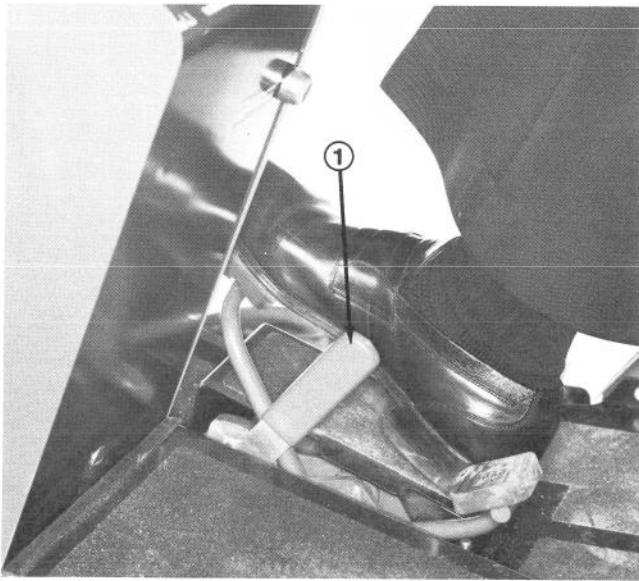

Figure 23
1. Ground Speed Limiter

port latches (Fig. 26). When driving from one area to another, use slower ground speed. Be careful when driving between objects so you do not accidentally damage the machine or cutting units.

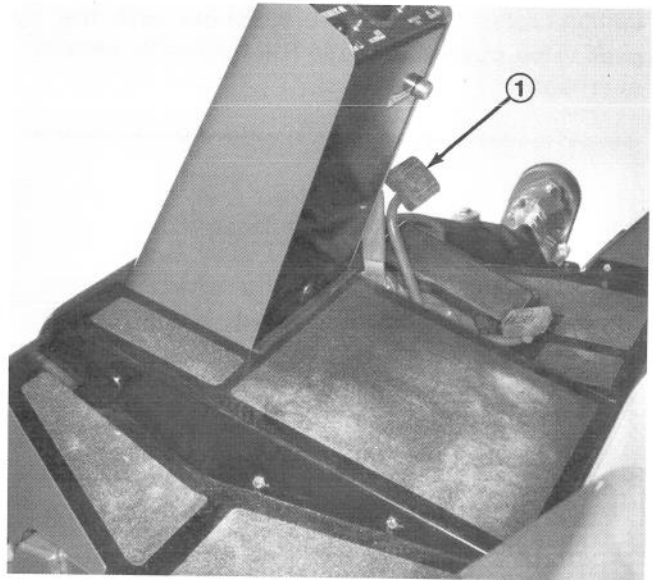

Figure 25
1. Traction Pedal



Figure 24
1. Reel Speed Control Knob

Start engine and move throttle to FAST so engine is running at maximum speed. Move Mow-Backlap lever to MOW (Fig. 11). Reels are now spinning. Disengage hand brake. To move forward and cut grass, press traction pedal forward (Fig. 25). Maintain traction pedal contact with ground speed limiter to assure consistent clip and quality-of-cut.

Transport – When mowing is complete, move MOW-BACKLAP lever to STOP. Raise cutting units by pulling back on lift control levers. Hold levers back until cutting units are fully raised (a squeal from the hydraulic system means cutting units are fully raised). Lock cutting units in place with trans-



Figure 26
1. Outside Cutting Unit Transport Latch

Matching Ground Speed and Reel Speed – Vary reel speed (while maintaining constant ground speed) to establish the best quality of cut for the area being mowed. Reel speeds either too fast or too slow for conditions may effect the quality of cut. Use the following cutting chart (Fig.27) and decal on steering console (Page 5) as a guide for initial adjustment of ground and reel speeds.

OPERATING INSTRUCTIONS

CUTTING CHARTS

Relate HOC and ground speed to required reel speed setting on a 1 thru 5 scale on reel speed knob.
 Note: 1 = 800 RPM; 2 = 900 RPM; 3 = 1000 RPM; 4 = 1100 RPM and 5 = 1200 RPM (Fig. 26).

* Speeds are approximate

Recommended Reel Speed Settings

5 Blade Reel

HOC	Ground Speed In MPH				
	3	4	5	6	7
1	1	3	5	N/R	N/R
1.25	N/R	1	3	5	N/R
1.5	N/R	N/R	2	3	4
2	N/R	N/R	N/R	1	2
2.5	N/R	N/R	N/R	N/R	1

7 Blade Reel

HOC	Ground Speed In MPH				
	3	4	5	6	7
1/2	2	5	N/R	N/R	N/R
5/8	1	3	5	N/R	N/R
3/4	N/R	1	3	5	N/R
1	N/R	N/R	1	2	3
1.25	N/R	N/R	N/R	1	2

11 Blade Reel

HOC	Ground Speed In MPH				
	3	4	5	6	7
3/8	1	3	5	N/R	N/R
1/2	N/R	1	3	4	N/R
5/8	N/R	N/R	1	2	4
3/4	N/R	N/R	N/R	1	2

Note: N/R = Not Recommended

Figure 27

MAINTENANCE SERVICE INTERVAL CHART

Date									
Hour Meter Reading									
Service Interval		100	200	300	400	500	600	700	800 1 Year
Check Parking Brake Operation	Daily								
Check Interlock Switch Operation	Daily								
Check Engine Oil Level	Daily								
Check Cooling System Fluid Level	Daily								
Check Reel to Bedknife Contact	Daily or A/R								
Check Hydraulic System Fluid Level	Daily								
Check Tire Pressure	Daily or A/R								
Drain Water From Fuel Separator	Daily or A/R								
Clean Debris From Radiator & Front Grill	Daily or A/R								
*Grease Five (5) Lift Arm Pivot Pins	Daily								
*Grease Cutting Unit Rollers	Daily								
*Grease Cutting Unit Reel Bearings	Daily								
*Grease Rear Axle (3 fittings)	Daily								
Service Air Cleaner Bowl, Dust Cup & Baffle	Daily or A/R								
*Grease Floatation or Fixed Head Pivots and Reel Control Valve	Weekly								
Check Cooling System Hoses & Connections	100 hrs								
Check Condition & Tension of Engine Belts	**100 hrs								
Check Battery Fluid & Cable Connections	100 hrs								
Change Engine Oil & Filter	**100 hrs								
Check Hydraulic Lines & Hoses	100 hrs								
Drain Water From Hydraulic Reservoir	200 hrs								
Tighten Wheel Nuts	**200 hrs								
Clean Air Cleaner Filter Element	**200 hrs or A/R								
Check Engine Valve Clearance	**Annually/500 hrs								
Replace Fuel Filter	500 hrs or A/R								
Change Planetary Gear Lube	**Annually/800 hrs								
Change Hydraulic System Filter	**Annually/800 hrs								
Check Rear Wheel Toe-In & Pack Rear Wheel Bearings	Annually/800 hrs								
Drain & Flush Cooling System	Annually/800 hrs								
Change Hydraulic System Breather	Annually/800 hrs								
Drain Water From Fuel Tank	Annually/800 hrs								
Replace Air Cleaner Filter Element	Annually/800 hrs								
Retorque Cylinder Head Bolts	**Annually/1000 hrs								
Change Hydraulic Oil	2 years								
Replace Seat Switch	2 Years								
Replace Hand Brake Switch	2 Years								
Replace Mow-Backlap Switch	2 Years								

* Use #2 Lithium Base Grease.

** Initial Service Interval - 50 operating hours.

A/R = As Required.

SERVICE SPECIFICATIONS

Engine Oil: All temperatures use SAE 10W30 SF, CD.

Hydraulic System Fluid: Refer to Hydraulic Oil Specifications (Page 8). Do not use engine oil in hydraulic system.

Filters: Hydraulic Oil (Toro part no. 58-6610); Air (Toro part no. 27-7110); Fuel (Toro part no. 60-5420);
Engine Oil (Toro part no. 49-2500); Hydraulic Reservoir Breather (Toro part no. 58-9070).

MAINTENANCE

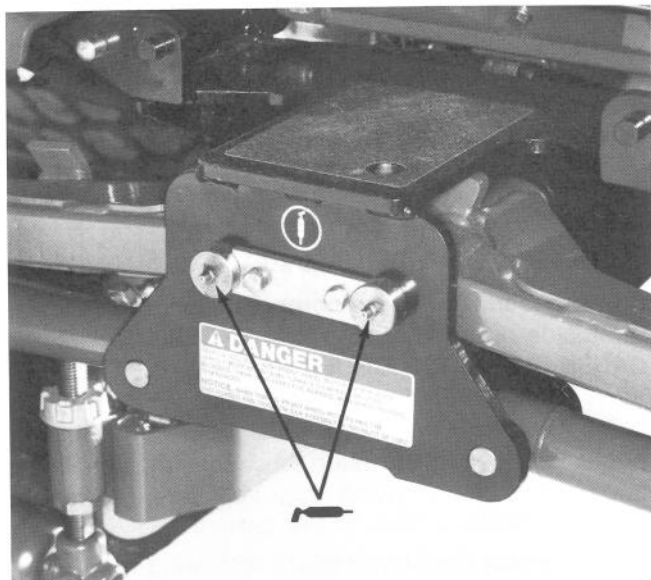

Figure 28
Lift Arms (5 fittings)



Figure 29
Rear Axle (3 fittings)

LUBRICATION

Areas to lubricate are pictured in figures 28–31. Use No. 2 lithium based grease. Also, grease fitting on Reel Control Valve (not shown), located under right hand console.

NOTE: Remove the plastic caps over the fittings on the floating or fixed head kit pivots and replace after greasing (Fig. 30).

AIR CLEANER

1. Precleaner Bowl Service (Fig. 32) – Normally, inspect precleaner bowl daily. When conditions are extremely dusty and dirty, inspect precleaner bowl more frequently. Do not let dust build up above level marks on precleaner bowl.

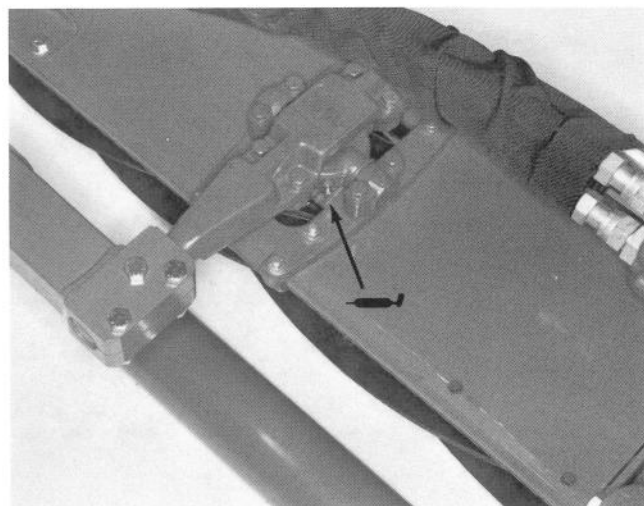

Figure 30
Floating or Fixed Head Kit Pivots
(Floating Head Kit Shown)

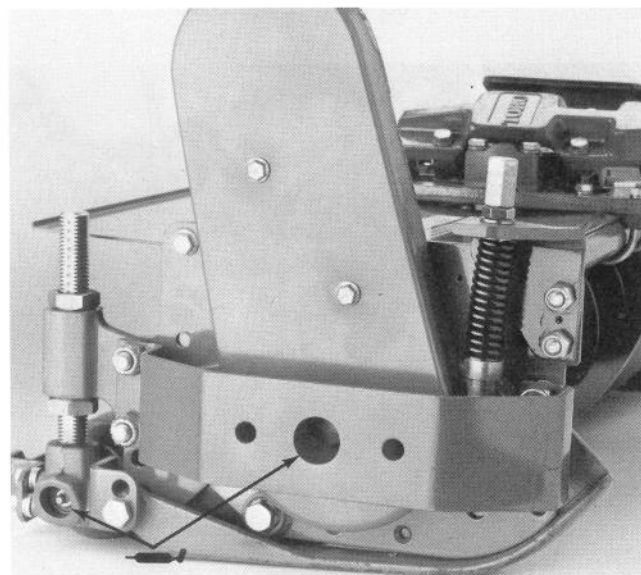

Figure 31
Reel & Roller Bearings

- A. Remove thumb screw. Separate cover and precleaner bowl.
- B. Dump dust and wipe precleaner bowl clean.
- C. Assemble and install precleaner bowl, cover and thumb screw.

2. Filter Service (Fig. 33) – Low power, excessive oil consumption and excessive exhaust smoke could mean that the filter needs cleaning. Service the air cleaner filter every 200 operating hours, or more frequently in dusty and dirty conditions. Replace filter after every six cleanings (800 hrs.) or annually, whichever comes first.

- A. Loosen mounting band screw. Remove dust cup and baffle assembly, then separate parts. Wipe dust cup clean and reassemble parts.

MAINTENANCE

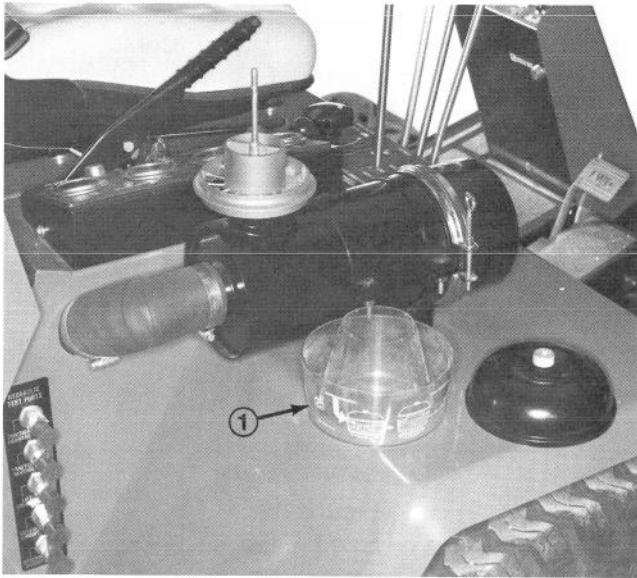

Figure 32
1. Pre-cleaner Dust bowl



Figure 33
1. Mounting Band
2. Dust Cup
3. Baffle
4. Wing Nut
5. Filter

B. Unscrew wing nut and slide filter out of body. Clean filter by washing or using compressed air.

Washing Filter – Soak filter for 15 minutes in a filter cleaner and water (cleaner part no. 27-7220 has complete instructions). DO NOT

REMOVE PLASTIC FIN ASSEMBLY. When clean, rinse filter with clean water. Do not use high water pressure (above 40 psi – 276 kPa) because it could damage the filter. Allow filter to air dry or use warm flowing air (160° F, 71° C). DO NOT USE COMPRESSED AIR OR A LIGHT BULB FOR DRYING A WET FILTER BECAUSE THE FILTER COULD BE DAMAGED.

Compressed Air – Blow compressed air from inside to outside of the filter. DO NOT EXCEED 100 psi BECAUSE THE FILTER COULD BE DAMAGED. TO PREVENT DAMAGE, KEEP AIR NOZZLE AT LEAST AN INCH AWAY FROM THE PAPER PLEATS. Shine a bright light inside the filter to check for cleanliness and defects (tears, holes, ruptures, fins, gasket and screen). Replace filter if it is defective.

C. Install filter and secure with wing nut. Place cap and baffle assembly against body and secure with mounting band.

ENGINE OIL AND FILTER

Change oil and filter after the first 50 hours of operation and every 100 hours thereafter.

1. Remove drain plug (Fig. 34) and let oil flow into drain pan. When oil stops, install drain plug.

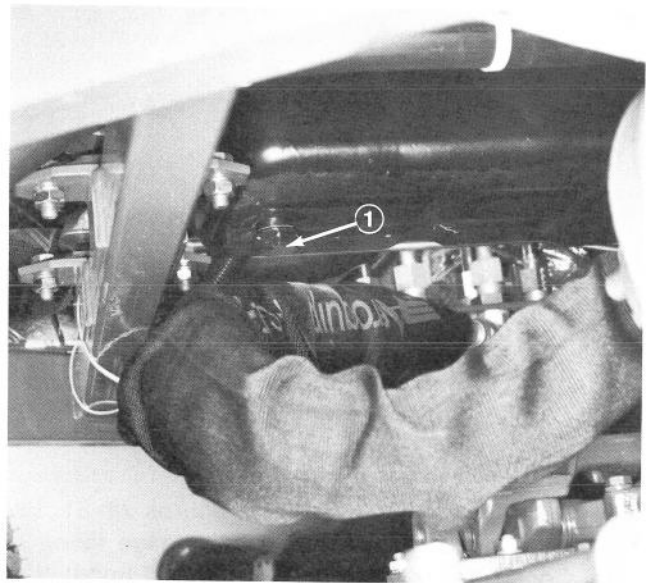

Figure 34
1. Drain Plug

2. Remove oil filter (Fig. 35). Apply a light coat of clean oil to the new filter seal before screwing it on. DO NOT OVER-TIGHTEN.

3. Add oil to crankcase.

MAINTENANCE

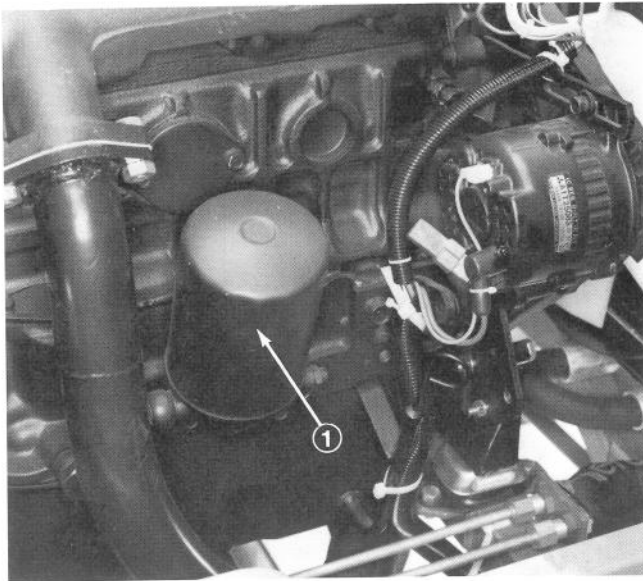

Figure 35
1. Oil Filter

filter (Fig. 37). Install drain plug and O-ring. Push wire connectors together.

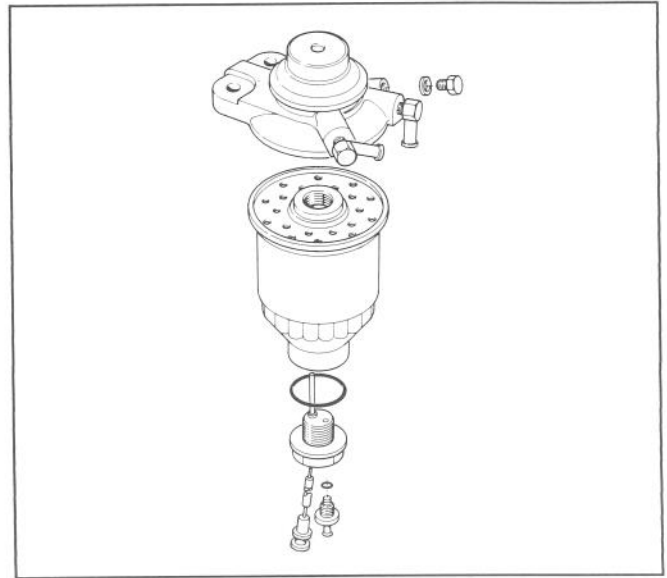

Figure 37

FUEL SYSTEM

1. Draining Water From Fuel System (Fig. 36) – Drain water from fuel system daily or when warning light indicates excess water has collected. To drain, loosen drain fitting on bottom of fuel filter. Drain into a container until only fuel is evident (Fig. 36).

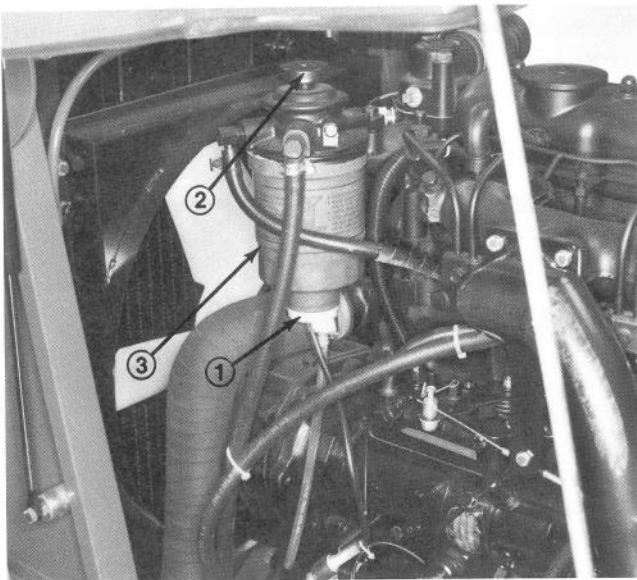

Figure 36
1. Drain Outlet
2. Plunger
3. Filter

2. Replacing Filter – Replace filter if fuel flow is restricted, after every 500 hours of operation, or annually, whichever comes first. To replace, disconnect wire connectors and unscrew drain outlet and O-ring (Fig. 37). Unscrew filter and replace with new Toro

ENGINE COOLING SYSTEM

1. Removing Debris – Remove debris from oil cooler, radiator and front screen daily, clean more frequently in dirty conditions.

A. Turn engine off, release front engine cover latches and raise engine cover. Hold engine cover upright with support rod. Clean engine area thoroughly of all debris.

B. Reach inside rear engine cover, release latches and open rear engine cover. (Fig. 38). Lift up on oil cooler handles and pivot rearward in mounting slot. Clean both sides of oil cooler, radiator and rear engine area thoroughly with compressed air. Pivot oil cooler back into position and latch front and rear engine covers.

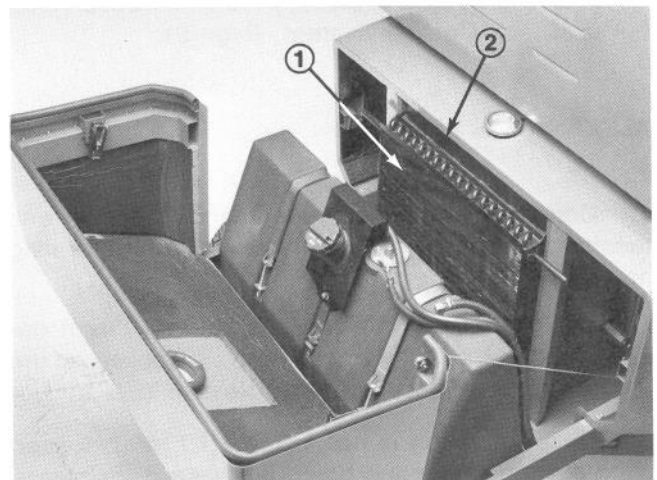

Figure 38
1. Oil Cooler
2. Radiator

MAINTENANCE

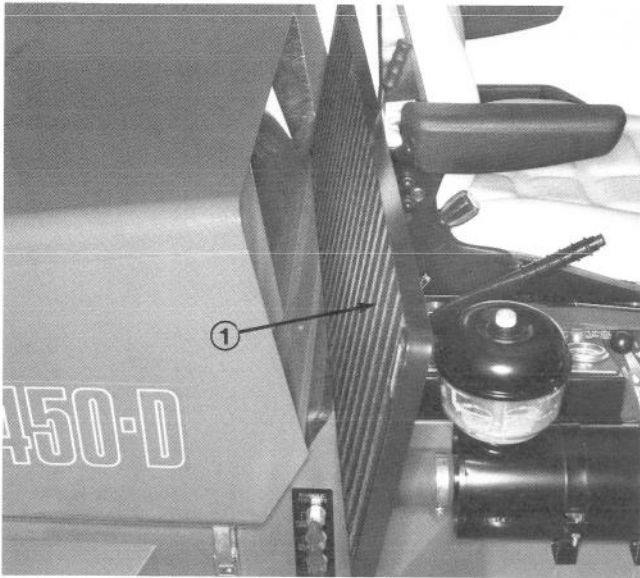

Figure 39
1. Front Grill

C. Remove front grill and clean it with compressed air (Fig. 39).

2. Maintaining Cooling System – Capacity of the system is 7.4 qt. (7 L). Always protect cooling system with a 50/50 solution of water and ethylene glycol anti-freeze. DO NOT USE WATER ONLY IN COOLING SYSTEM.

A. After every 100 operating hours, tighten hose connections. Replace any deteriorated hoses.

B. After every 800 operating hours, drain and flush the cooling system. Add anti-freeze (refer to Check Cooling System, Page 9).

ALTERNATOR BELT

1. Condition and Tension – Check condition and tension of belts (Fig. 40) after every 100 operating hours.

A. Proper tension will allow 3/8 in. (10 mm) deflection when a force of 10 lbs. is applied on the belt midway between the pulleys (Fig. 40).

B. If deflection is not 3/8 in. (10 mm), loosen alternator mounting bolts. Increase or decrease alternator belt tension and tighten bolts. Check deflection of belt again to assure tension is correct.

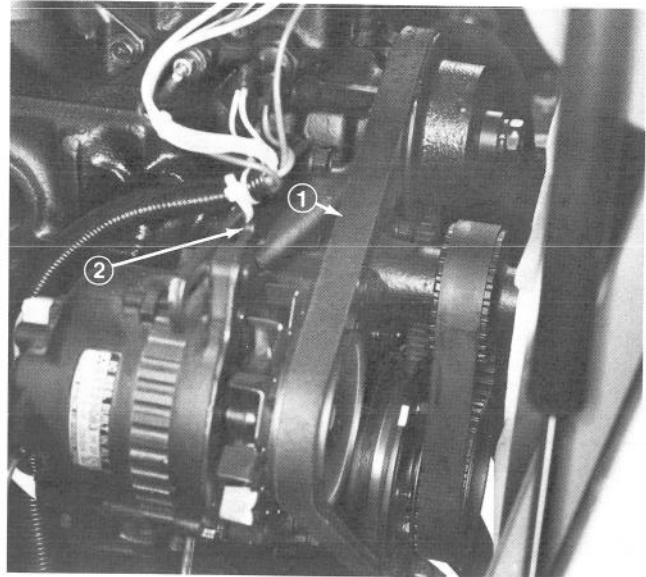

Figure 40
1. Alternator Belt
2. Mounting Bolt

CYLINDER HEAD BOLTS

Retorque initially after 50 operating hours and check every 1000 operating hours or annually thereafter (refer to engine manual).

ENGINE VALVE CLEARANCE

1. Adjust initially at 50 operating hours and check every 500 operating hours or annually thereafter (refer to engine manual).

BATTERY CARE



Figure 41
1. Battery Cover
2. Capscrews
3. Battery

MAINTENANCE

Check battery and cable connections after every 100 operating hours.

1. Loosen capscrews securing battery cover (Fig. 41).
2. Remove cover by sliding cover forward until slotted holes in cover align with capscrews.
3. If battery or cables are damaged, worn or loose, make necessary repairs.
4. Check electrolyte level in each cell.
5. Install battery cover and secure with capscrews.

ADJUSTING HAND BRAKE & TRACTION SWITCHES

In time, the hand brake cable may stretch, causing the engine not to start. If this happens, adjust the cable (Fig. 42).

1. Pull hand brake lever to 3rd click.
2. Rotate cable adjusting nut clockwise until brakes hold machine securely.
3. Pull hand brake up one additional click.
4. Adjust four U-bracket nuts (Fig. 42) equally so spring has tension. Adjustment affects operation of traction switches.
5. Adjust four U-bracket nuts (Fig. 42) so engine will start and run when hand brake is at fourth click, but will not start or run when hand brake is at second click.

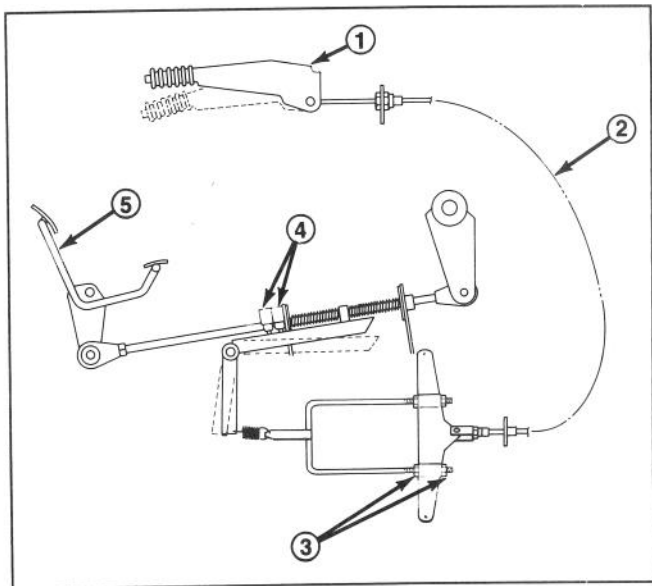

Figure 42

1. Parking Brake
2. Brake Cable
3. U-bracket Nuts
4. Traction Switches
5. Traction Pedal

ADDING HYDRAULIC OIL

Capacity of the hydraulic reservoir is approximately 15 gal. (58 L). With machine on a level surface, hydraulic oil level should be 1/4 to 1/2 inch below arrows on sight glass, when oil is cold. Warm oil should be even with arrows on sight glass (Fig. 43). If level is low, add hydraulic oil. Refer to Hydraulic Oil Specifications (Page 8).



Figure 43

1. Arrows

1. Remove seat lock pin (Fig. 16), raise the seat and hold open with support rod.

2. Clean around reservoir cover (Fig. 44). Remove cover and add hydraulic oil until it is even with arrows on sight glass (Fig. 43).

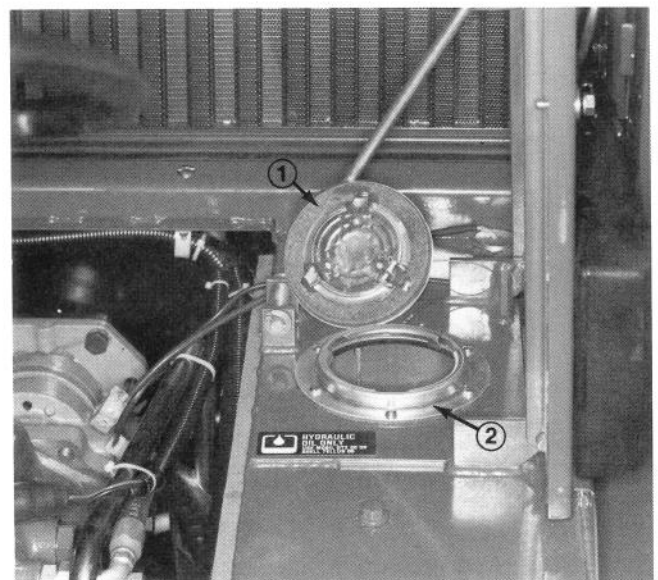

Figure 44

1. Reservoir Cover
2. Hydraulic Filler Opening

MAINTENANCE

IMPORTANT: To prevent contamination, clean top of hydraulic oil containers before puncturing. Assure pour spout and funnel are clean.

4. Install reservoir cover, lower the seat and secure with lock pin.

DRAINING WATER FROM HYDRAULIC RESERVOIR

After every 200 operating hours, drain water from hydraulic reservoir.

1. Open drain plug (Fig. 45) one-half turn and allow fluid to flow into drain pan until water is not noticed in the hydraulic oil.

2. Tighten drain plug and add hydraulic oil (refer to Adding Hydraulic Oil, Page 25).

CHANGING HYDRAULIC OIL

Normally, change hydraulic oil after every 2 years or 1600 operating hours. If oil becomes contaminated, contact your local TORO distributor because the system must be flushed. Contaminated oil looks milky or black when compared to clean oil.

1. Remove drain plug (Fig. 45) from reservoir and let hydraulic oil flow into drain pan. Tighten plug when hydraulic oil stops draining.

2. Fill reservoir with approximately 15 gallons of hydraulic oil. Refer to Hydraulic Oil Specifications (Page 8).

IMPORTANT: Use only hydraulic oils specified. Other fluids could cause system damage.

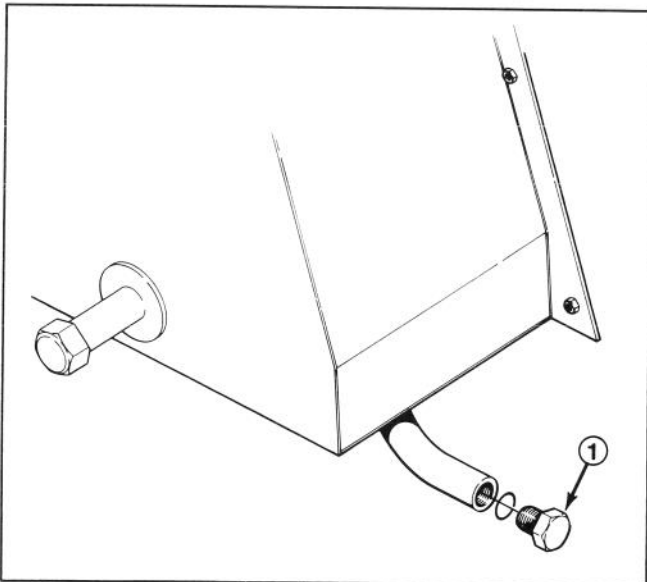

Figure 45

1. Drain Plug

3. Install reservoir cover, lower seat and secure with lock pin. Start engine and use all hydraulic controls to distribute hydraulic oil throughout the system. Also check for leaks. Then stop the engine.

4. With cutting units up and oil warm, look into sight glass (Fig. 43). If hydraulic oil is not even with arrows, add enough to raise to proper level. Do not fill full if oil is cold.

REPLACING HYDRAULIC FILTER

Initially, change filter after the first 50 operating hours, thereafter, every 800 operating hours, annually, or on indication.

Only the Toro replacement filter (Part No. 58-6610) can be used in the hydraulic system. Using any other filter voids the warranty, and may cause component failure or premature wear.

1. Remove seat lock pin, raise seat and hold open with support rod. Also remove panel (secured with magnets) ahead of the seat.

2. Clean area around filter mounting area (Fig. 46). Place drain pan under filter and remove filter.

3. Lubricate new filter gasket and fill the filter with hydraulic oil.

4. Assure filter mounting area is clean. Screw filter on until gasket contacts mounting plate. Then tighten filter one-half turn.

5. Start engine and let run for about two minutes to purge air from the system. Stop the engine and check for leaks.

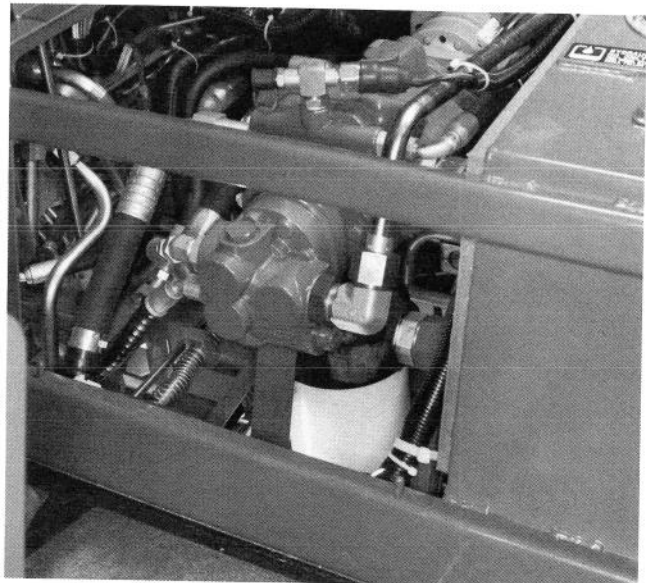

Figure 46

1. Hydraulic Filter

6. Look into sight glass (Fig. 43). Hydraulic oil level should be even with arrows when oil is warm. If level is low, add hydraulic oil to the reservoir. Refer to Hydraulic Oil Specifications (Page 8).

MAINTENANCE

Note: Under certain conditions, a bypass valve in the filter mounting plate allows oil to bypass the filter. Before the filter starts to bypass a warning light on the steering console will illuminate. The warning light may come on momentarily when the oil is cold. If the light does not go out after the oil is warm, the filter is clogged or an electrical problem exists. Correct problem before commencing operation.

REPLACING HYDRAULIC SYSTEM BREATHER

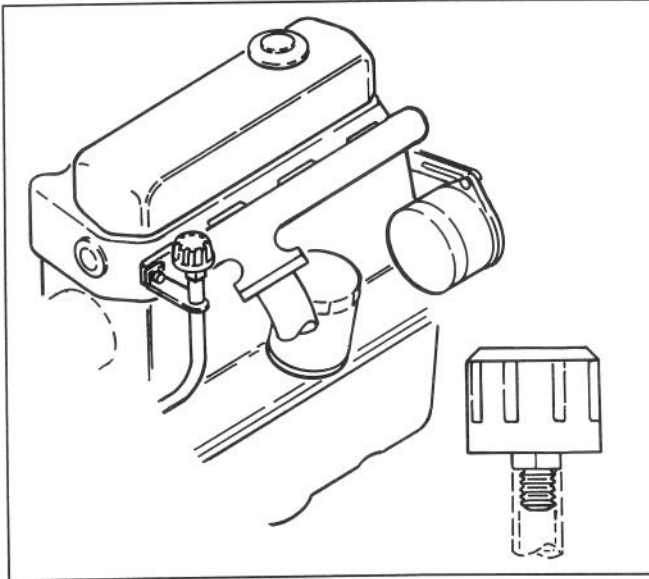

Figure 47

Change hydraulic system breather after every 800 operating hours, or annually, whichever comes first. More often in extremely dusty or dirty conditions.

1. Release latches, open engine cover and hold it upright with support rod.
2. Clean around the breather and unscrew it with a wrench (Fig. 47). Install a new breather.
3. Close engine cover and latch securely.

CHECKING HYDRAULIC LINES AND HOSES

After every 100 operating hours, check hydraulic lines and hoses for leaks, kinked lines, loose mounting supports, wear, loose fittings, weather deterioration and chemical deterioration. Make all necessary repairs before operating.

HYDRAULIC SYSTEM TEST PORTS

The test ports (Fig. 48) are used to test the hydraulic circuits. Check all pressures when engine is at full speed and hydraulic oil is at normal operating tem-

perature. Contact your local Toro distributor for assistance.

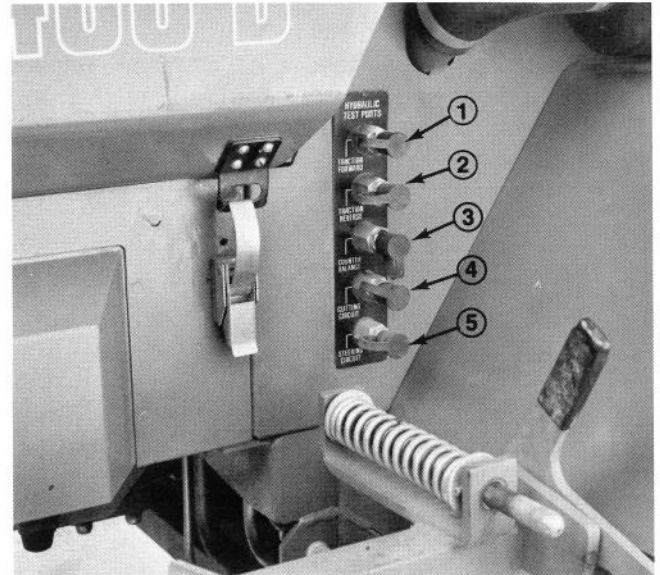

Figure 48

1. Traction Forward
2. Traction Reverse
3. Cutting Unit Counterbalance
4. Cutting Circuit
5. Steering Circuit

1. Traction Forward and Reverse has a normal relief setting of approximately 5300 psi and 50 – 150 psi charge pressure. Use a gauge with 7500 – 10,000 psi full scale rating.

2. Cutting unit Counterbalance has adjustable pressure.

Normal Setting	Hot Oil: 500–550 psi
	Cold Oil: 600–650 psi
Maximum Hill Climbing Setting	
	Hot Oil: 550+ psi
	Cold Oil: 650+ psi
Maximum Quality of Cut Setting	
	Hot Oil: 500 psi
	Cold Oil: 600 psi

Lift circuit relief pressure is approximately 2650 psi when counterbalance setting is 550 psi.

Note: Changes in counterbalance setting will effect the lift circuit relief pressure.

3. Cutting Circuit has a normal relief setting of approximately 2700–3000 psi.

4. Steering Circuit has a normal relief setting of approximately 1500 psi.

NOTE: Test ports for Lift/Relief (on valve) and Charge Pressure (on pump) are under seat.

MAINTENANCE

REAR WHEEL TOE-IN

After every 800 operating hours or annually, check rear wheel toe-in.

1. Measure center-to-center distance (at axle height) at front and rear of steering tires (Fig. 49). Front measurement must be 1/8 in. less than rear measurement.

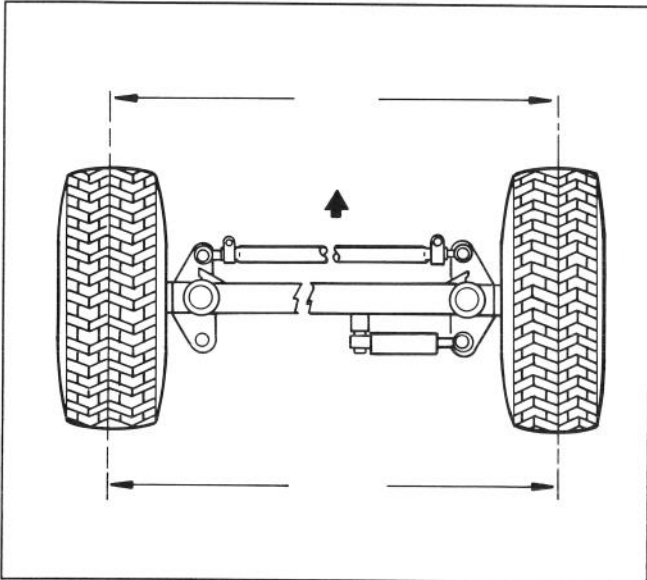

Figure 49

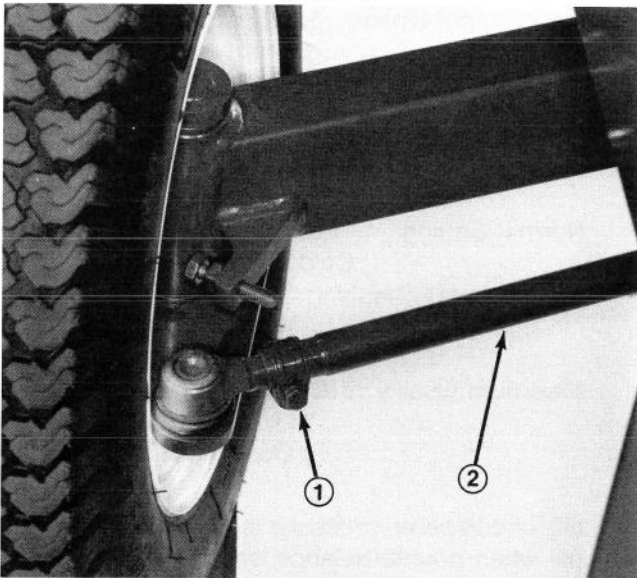

Figure 50

1. Clamp
2. Tie Rod

To adjust:

2. Loosen clamps at both ends of tie rods (Fig. 50).
3. Rotate tie rod (Fig. 50) to move front of tire inward or outward.
4. Tighten tie rod clamps when adjustment is correct.

CHECKING PLANETARY GEAR DRIVE

Initially, check oil level after 50 operating hours and check every 800 hours thereafter. Oil capacity is approximately 30 oz. (885 ml) high quality 80-90 wt. Gear Lube.

1. To check the oil level, the oil should be at the bottom of the check/drain plug hole (Fig. 51) when the hole is placed in the 3 o'clock or 9 o'clock position. The traction unit must be on level ground when making this check.

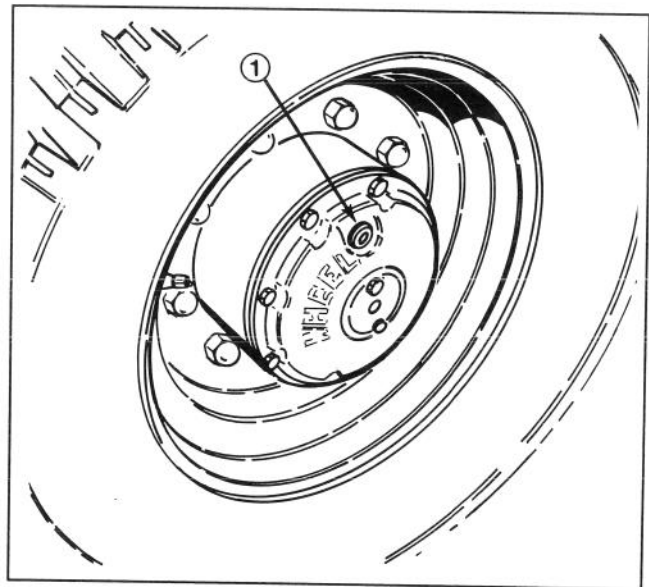

Figure 51

1. Check/Drain Plug

OPTIONAL EQUIPMENT

5 Blade L. H. Cutting Unit, Model No. 03752 (2 per machine)

5 Blade R. H. Cutting Unit, Model No. 03753 (3 per machine)

7 Blade L. H. Cutting Unit, Model No. 03754 (2 per machine)

7 Blade R. H. Cutting Unit, Model No. 03756 (3 per machine)

11 Blade L. H. Cutting Unit, Model No. 03741 (2 per machine)

11 Blade R. H. Cutting Unit, Model No. 03751 (3 per machine)

L. H. Dethatcher Kit, Model No. 03730 (2 per machine)

R. H. Dethatcher Kit, Model No. 03732 (3 per machine)

Cutting Unit Floatation Kit, Model No. 03760 (1 per machine)

Cutting Unit Fixed Head Kit, Model 03762 (1 per machine)

Front Roller Kit, Model No. 03742 (1 per machine)

Wiehle Roller Kit, Model No. 03740 (1 per machine)

Rear Roller Scraper Kit, Part No. 59-6090 (1 per cutting unit)

Front Roller Scraper Kit, Part No. 62-6220 (1 per cutting unit)

Side Skid Kit, Model No. 03744 (1 per machine)

Lighting Kit, Model 03774

Spark Arrester Muffler Kit, Part No. 74-2900

Roll Over Protection Kit, Contact Your Local Toro Distributor.

ELECTRICAL SCHEMATIC

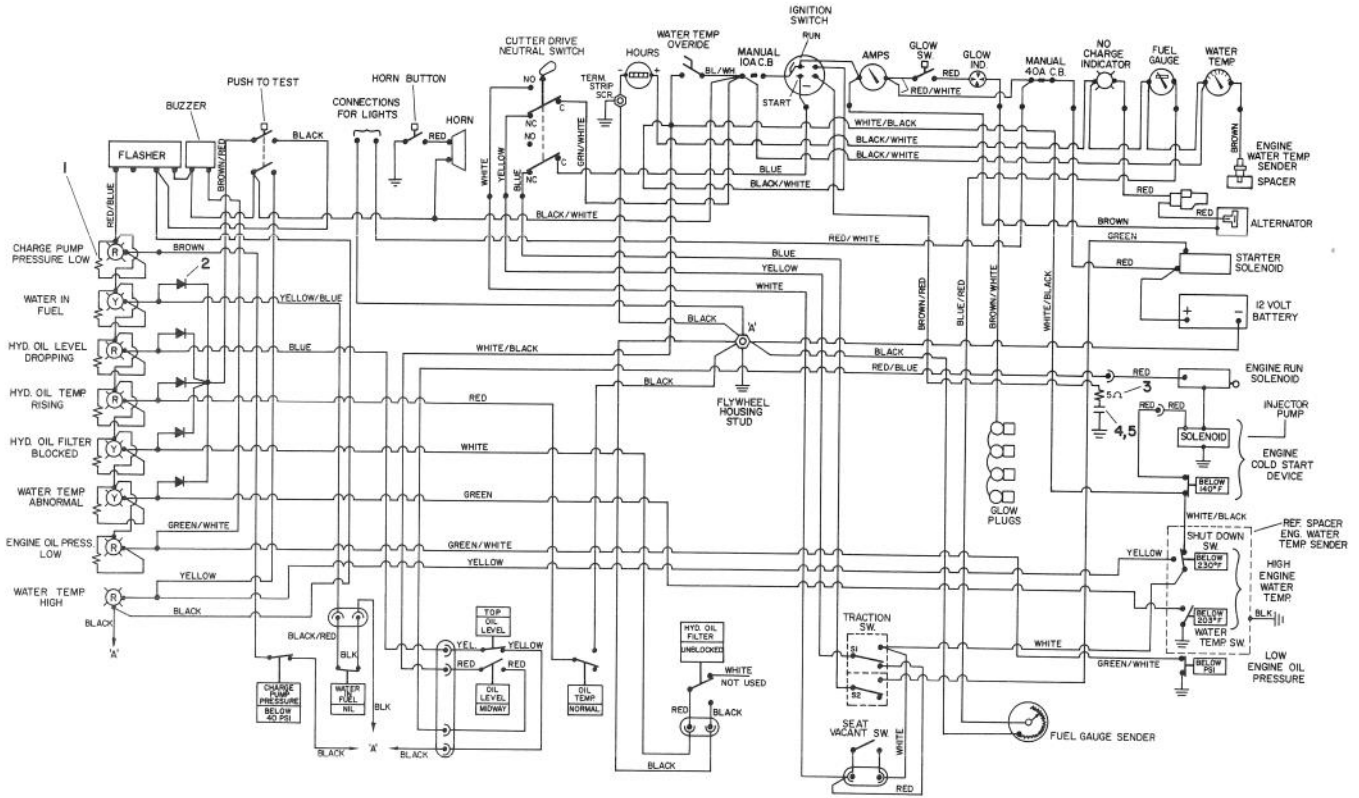

NOTES

The Toro Promise

A ONE YEAR LIMITED WARRANTY

The Toro Company promises to repair your TORO Product if defective in materials or workmanship. The following time periods from the date of purchase apply:

Commercial Products 1 Year

The costs of parts and labor are included, but the customer pays the transportation costs on walk rotary mowers with cutting unit widths of less than 25".

If you feel your TORO product is defective and wish to rely on The Toro Promise, the following procedure is recommended:

1. Contact your Authorized TORO Distributor or Commercial Dealer (the Yellow Pages of your telephone directory is a good reference source).
2. The TORO Distributor or Commercial Dealer will advise you on the arrangements that can be made to inspect and repair your product.
3. The TORO Distributor or Commercial Dealer will inspect the product and advise you whether the product is defective and, if so, make all repairs necessary to correct the defect without an extra charge to you.

If for any reason you are dissatisfied with the distributor's analysis of the defect or the service performed, you may contact us.

Write:

TORO Commercial Products Service Department
8111 Lyndale Avenue South
Minneapolis, Minnesota 55420

The above remedy of product defects through repair by an Authorized TORO Distributor or Commercial Dealer is the purchaser's sole remedy for any defect.

THERE IS NO OTHER EXPRESS WARRANTY. ALL IMPLIED WARRANTIES OF MERCHANTABILITY AND FITNESS FOR USE ARE LIMITED TO THE DURATION OF THE EXPRESS WARRANTY.

Some states do not allow limitations on how long an implied warranty lasts, so the above limitation may not apply to you.

This Warranty applies only to parts or components which are defective and does not cover repairs necessary due to normal wear, misuse, accidents, or lack of proper maintenance. Regular, routine maintenance of the unit to keep it in proper condition is the responsibility of the owner.

All warranty repairs reimbursable under the Toro Promise must be performed by an Authorized TORO Commercial Dealer or Distributor using Toro approved replacement parts.

Repairs or attempted repairs by anyone other than an Authorized TORO Distributor or Commercial Dealer are not reimbursable under the Toro Promise. In addition, these unauthorized repair attempts may result in additional malfunctions, the correction of which is not covered by warranty.

THE TORO COMPANY IS NOT LIABLE FOR INDIRECT, INCIDENTAL OR CONSEQUENTIAL DAMAGES IN CONNECTION WITH THE USE OF THE PRODUCT INCLUDING ANY COST OR EXPENSE OF PROVIDING SUBSTITUTE EQUIPMENT OR SERVICE DURING PERIODS OF MALFUNCTION OR NON-USE.

Some states do not allow the exclusion or limitation of incidental or consequential damages, so the above limitation or exclusion may not apply to you.

This warranty gives you specific legal rights, and you may also have other rights which vary from state to state.

COUNTRIES OTHER THAN THE UNITED STATES OR CANADA

Customers who have purchased TORO products exported from the United States or Canada should contact their TORO Distributor (Dealer) to obtain guarantee policies for your country, province or state. If for any reason you are

dissatisfied with your Distributor's service or have difficulty obtaining guarantee information, contact the TORO importer. If all other remedies fail, you may contact us at The Toro Company.