



300/400-Series
8-Speed
Garden Tractors



Wheel Horse
Operator's Manual

Specifications
Operating Instructions
Maintenance Information

FOR YOUR SAFETY

Two of the most potentially serious types of accidents involving power mowers are contact with the mower blade and overturning the rider/tractor. To minimize the possibility of having these types of accidents, read

and follow these instructions. Also refer to the Safe Operation Practice in this Operator's Manual for other important safety information.

FOR BEST PERFORMANCE:

- FOLLOW OPERATOR'S MANUAL INSTRUCTIONS
- OPERATE ENGINE AT FULL THROTTLE
- CHECK AND ADJUST MOWER LEVEL PERIODICALLY
- CLEAN UNDERSIDE OF MOWER FREQUENTLY
- KEEP MOWER BLADES SHARP AND BALANCED
- KEEP P.T.O. AND BELTS ADJUSTED

BEFORE EACH USE:

- CHECK SAFETY INTERLOCK SYSTEM
- CHECK ENGINE OIL LEVEL
- CHECK BATTERY WATER LEVEL
- CHECK TRANSMISSION OIL LEVEL (AUTOMATIC)
- CHECK GENERAL EQUIPMENT CONDITION
- CLEAN ENGINE CHAFF SCREEN

EVERY 25 HOURS:

- CHECK TIRE PRESSURE: INFLATE TO 12 P.S.I.
- CHECK FASTENERS: IN PLACE AND TIGHT
- CHECK TRANSMISSION OIL LEVEL (8 SPEED)
- LUBRICATE CHASSIS AND FRONT WHEELS
- SEE OPERATOR'S MANUAL FOR OIL CHANGE, OIL FILTER & AIR FILTER SERVICE INTERVAL

LOCATED ON REAR OF HOOD - DECAL PART NUMBER 116544

RIDER/TRACTOR STABILITY

ALWAYS:

Vehicle stability changes with conditions and is affected by:

- Slope angle and length/bumps/holes, etc.
- Slippery conditions (lawn moisture and length)
- Operator size and position/how loaded/equipment used
- Speed/braking/steering changes
- Operator physical limitations/alertness

- Use good judgement when operating the rider/tractor, especially on slopes.
- Maintain the vehicle in good operating condition.
- Be attentive to changing conditions affecting vehicle stability.

NEVER:

- Operate vehicle on extreme slopes.
- Operate vehicle across slopes.
- Abruptly change speed or direction.



DANGER

TO AVOID INJURY

- STOP BLADE & BACK SLOWLY IF MACHINE STOPS GOING UPHILL • NEVER MOW NEAR PEOPLE
- NEVER USE WHEN UNDER INFLUENCE OF DRUGS OR ALCOHOL • NEVER CARRY PASSENGERS
- SET PARKING BRAKE & REMOVE KEY IF LEAVING MACHINE • AVOID SLIPPERY OR STEEP AREAS
- AVOID BLADE UNLESS BLADE & ENGINE ARE STOPPED • USE SAFELY; MACHINE IS NOT A TOY
- KNOW LOCATION AND FUNCTION OF CONTROLS • REMOVE POTENTIAL THROWN OBJECTS
- KEEP SAFETY DEVICES IN PLACE AND WORKING • LOOK BEHIND MACHINE BEFORE BACKING

READ OWNER'S MANUAL

ON FRAME IN FRONT OF GEAR SHIFT LEVER - PART NUMBER 112678



DANGER

TO AVOID INJURY

NEVER MOW
SIDE HILL
OVER 5°



NEVER MOW
UP HILL
OVER 10°



NEVER MOW
SLOPE
OVER 15°



LOCATED ON FRONT OF REAR FENDER - DANGER DECAL PART NUMBER 112679

BLADE CONTACT

! DANGER! Mower Blades are Designed to CUT: therefore,

ALWAYS:

- Shut off engine and set parking brake.
- Remove ignition key.
- Allow moving parts to stop before dismounting, servicing, or cleaning unit.

NEVER:

- Perform ANY work on the mower with engine running.
- Mow with other people around, especially children.
- Leave mower unattended.



LOCATED ON MOWER DEFLECTOR AND CUTTER DECK
DECAL PART NUMBER 54-9220

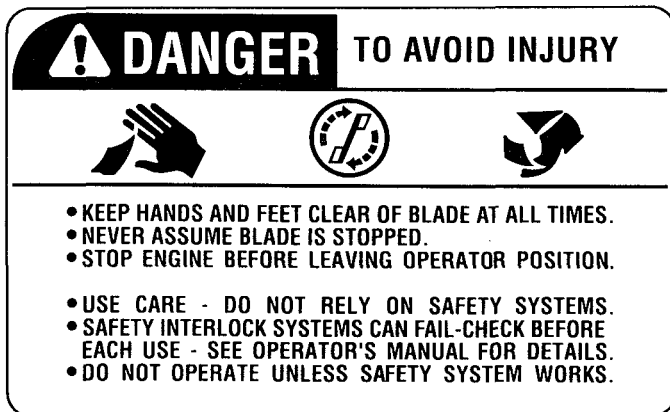

LOCATED ON FRAME PLATE UNDER STEERING WHEEL
DECAL PART NUMBER 78-8470



LOCATED ON MOWER DEFLECTOR AND CUTTER DECK
DECAL PART NUMBER 66-1340

LOCATED ON FRONT OF REAR FENDER - DANGER DECAL PART NUMBER 112679

DECALS WITH LOCATIONS

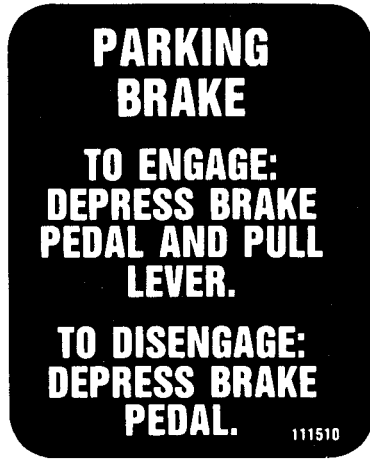

LEFT SIDE ON FRAME PLATE NEXT TO PARKING BRAKE CONTROL - PART NUMBER 111510

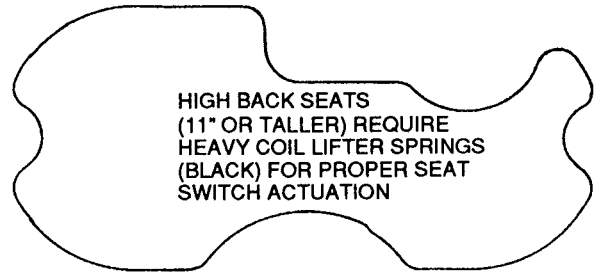

UNDER SEAT SPRINGS
PART NUMBER 114296



UNDER STEERING WHEEL ON HOODSTAND
310 ONLY - PART NUMBER 119170
312 ONLY - PART NUMBER 119190
416 ONLY - PART NUMBER 119200

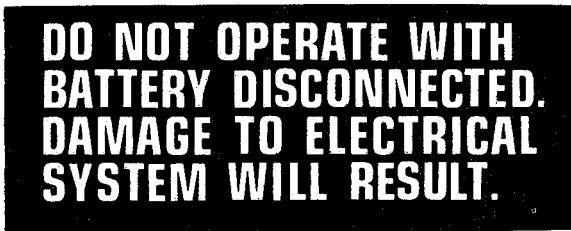

ON INSIDE HOODSTAND NEXT TO BATTERY
PART NUMBER 111926

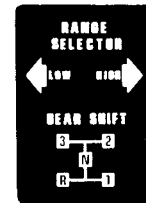

ON RIGHT SIDE OF FRAME PLATE
NEXT TO GEAR SHIFT
PART NUMBER 111534

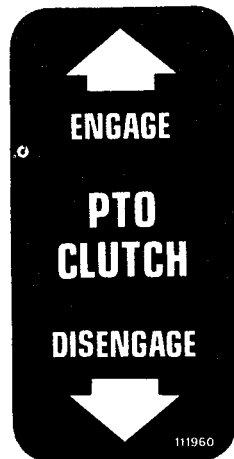

UNDER IGNITION SWITCH ON HOODSTAND
PART NUMBER 111960



UNDER STEERING WHEEL ON HOODSTAND
PART NUMBER 119220



ON LEFT AND RIGHT MID-HITCH
PART NUMBER 115197

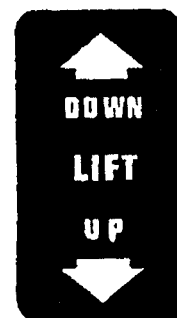

UNDER LIGHT SWITCH ON HOODSTAND
PART NUMBER 112168

CONTENTS

	Page		Page
Tractor Specifications	II,III	Operation of Tractor	6-8
General Safety Suggestions	IV, V, VI	With a Mower	7
Model and Serial Number	1	With a Snowthrower	7
Registration and Warranty	1	With a Snow, Dozer or Grader Blade	7
Parts Manual	1	With a Tiller	7
Instruments and Controls	2-3	With a Plow, Disc Cultivator, or Harrow (312,416 Models)	7-8
Operating Your Tractor	4-5	With a Rear Bagger	8
Safety Interlock System	4	With Other Attachments	8
Seat Control	4	Maintaining Your Tractor	9-16
Correct Engine Operation	4	Maintenance Checklist	9
Starting Engine	4	Engine	9-13
Stopping Engine	4	Cooling	9
Throttle and Choke Control	4	Oil Quality	9
Fuel Specification	5	Oil Level	9
Oil Specification	5	Oil Changes	10
Correct Mechanical Transmission Operation	5	Air Filter	11-12
To Go Forward or Reverse	5	Crankcase Breather	12
To Change Speeds or Direction	5	Spark Plug(s)	12-13
To Stop	5	Electronic Ignition	13
Correct Tractor Usage	6-8	Fuel System	13
Attachment Mounting	6	Carburetor Adjustment	13
Hitches	6	Charging and Electrical System	13-14
Attachment Belts	6	Alternator	13
(Con't)		Main Fuse	14
		Light Circuit Fuse	14
		Gage Circuit Fuse	14
		Battery	14
		Light Bulb Replacement	14
		8-Speed Transmission	14-15
		Oil Quality	14
		Oil Level	14
		Chassis Lubrication	15
		Foot Brake Adjustment	15
		PTO Clutch & Brake Adjustment	15
		Exhaust System	16
		Cleaning and Storage	16
		Trouble Shooting Checklist	17-18
		Wiring Diagrams	19-21

These symbols mark important instructions relating to your personal safety. To avoid possibility of injury, read and follow such instructions carefully.

⚠ DANGER ⚠ *This symbol warns of extreme immediate hazards which would result in high probability of severe personal injury or death if proper precautions are not taken.*

⚠ CAUTION ⚠ *This symbol warns of a hazard or unsafe practice which can result in personal injury if proper precautions are not taken.*

When manual refers to left or right side of vehicle, it means your left or right when sitting in driver's seat.

**SPECIFICATIONS:
ENGINE:**

TRACTOR MODEL	ENGINE MODEL*	RATED H.P.**	DISPLACEMENT cu. in./cc	BORE in./mm	STROKE in./mm	IGNITION
310	M10S	10	23.8/390	3.25/82.6	2.88/72.9	Electronic
312	M12S	12	29.07/476.4	3.38/85.7	3.25/82.6	Electronic
416	P216	16	43.3/710	3.25/82.6	2.62/66	Electronic

*Letter Prefix: M=Kohler and P=TORO POWER PLUS. Basic engine model number shown; type and serial numbers from engine I.D. plate are required to completely identify engine. **Engine manufacturer's rating at 3600 RPM

TRANSMISSION:

310-MODEL 8-SPEED

Type: Mechanical All Gear

Approximate Ground Speeds (at full throttle):

Gear	Low Range	High Range
1st	.5 mph (.8 kph)	2 mph (3.2 kph)
2nd	.8 mph (1.3 kph)	3.2 mph (5.7 kph)
3rd	1.4 mph (2.2 kph)	5.5 mph (8.8 kph)
Rev.	.7 mph (1.1 kph)	2.6 mph (4.2 kph)

312-MODEL 8-SPEED

Type: Mechanical All Gear

Approximate Ground Speeds (at full throttle):

Gear	Low Range	High Range
1st	.5 mph (.8 kph)	2 mph (3.2 kph)
2nd	.8 mph (1.3 kph)	3.2 mph (5.7 kph)
3rd	1.4 mph (2.2 kph)	5.5 mph (8.8 kph)
Rev.	.7 mph (1.1 kph)	2.6 mph (4.2 kph)

416-MODEL 8-SPEED

Type: Mechanical All Gear

Approximate Ground Speeds (at full throttle):

Gear	Low Range	High Range
1st	.5 mph (.8 kph)	2 mph (3.2 kph)
2nd	.8 mph (1.3 kph)	3.2 mph (5.7 kph)
3rd	1.4 mph (2.2 kph)	5.5 mph (8.8 kph)
Rev.	.7 mph (1.1 kph)	2.6 mph (4.2 kph)

ELECTRICAL SYSTEM:

	310, 312	416
Type:	12 Volt D.C., Negative Ground	12 Volt D.C., Negative Ground
Alternator:	12 Volt, 15 amp. Regulated	12 Volt, 20 amp. Regulated
Battery:	12 Volt, 24 amp hr., 160 CCA	12 Volt, 24 amp hr., 200 CCA

TIRES:

	SIZES - FRONT	SIZES - REAR	PRESSURE - FRONT	PRESSURE - REAR
310	15 x 6.00-6	23 x 8.50-12	12 psi (.85 kg/cm ²)	12 psi (.85 kg/cm ²)
312	15 x 6.00-6	23 x 9.50-12	12 psi (.85 kg/cm ²)	12 psi (.85 kg/cm ²)
416	16 x 6.50-6	23 x 9.50-12	12 psi (.85 kg/cm ²)	12 psi (.85 kg/cm ²)

SPECIFICATIONS (continued):

PHYSICAL DATA:

MODEL	HEIGHT	LENGTH	OVERALL WIDTH	WHEEL BASE	INSIDE TURNING RADIUS	NET WEIGHT (Approximate)
310	40.5 in. (102 cm)	65 in. (165 cm)	36.5 in. (93 cm)	45.5 in. (116 cm)	36 in. (91 cm)	553 lbs. (252 kg)
312	42.5 in. (108 cm)	65 in. (165 cm)	36.5 in. (93 cm)	45.5 in. (116 cm)	36 in. (91 cm)	553 lbs. (252 kg)
416	43.5 in. (111 cm)	65 in. (165 cm)	36.5 in. (93 cm)	45.5 in. (116 cm)	36 in. (91 cm)	566 lbs. (258 kg)

TUNE-UP/GENERAL MAINTENANCE SPECIFICATIONS:

ENGINE:

MACHINE MODEL	POINT GAP in./mm	TIMING MARK LOCATION	IGNITION TIMING (BTDC)	SPARK PLUG TYPE*	SPARK PLUG GAP in./mm	DIRECTION OF ROTATION (Facing Drive Pulley)	IDLE RPM (No Load)	GOVERNED MAX. RPM (No Load)
310,312	N/A	N/A	Fixed	RH10	.025/.64	Counterclockwise	1000	3400
416	N/A	N/A	Fixed	RS14YC	.025/.64	Counterclockwise	1400	3400

* Or equivalent (Champion number shown)

LUBRICANT/FUEL CAPACITIES:

CRANKCASE:

310,312 2.5 qts. (2.3 l)
416 1.5 qts. (1.4 l) w/o Filter
1.8 qts. (1.7 l) w/Filter

FUEL TANK:

9 qts. (8.6 l)

CHASSIS:

Grease Fittings : 8

SAFE OPERATION PRACTICES — RIDING VEHICLES

GENERAL

1. This machine is capable of amputating hands and feet and can throw objects that can cause injury and damage. **KNOW** the controls and how to stop machine quickly. **READ THIS OPERATOR'S MANUAL** and instructions furnished with attachments. Read, understand, and obey all safety messages appearing on the machine and in the operator's manual. **LEARN** from your operator's manual and from careful **EXPERIENCE** how to operate your equipment correctly. Know your machine's limitations.
2. Keep hands, feet, hair and loose clothing away from attachment discharge area, underside of mower deck or any moving parts while engine is running.
3. The use of drugs or alcohol while operating any equipment will place your safety in peril. Do not attempt operation of this machine while taking drugs or medication or while drinking alcoholic beverages.
4. Only responsible persons with mature judgment and proper physical capabilities should be allowed to operate this machine, and only after instruction in the proper use of this equipment.
5. Do not allow children to operate machine.
6. Do not carry passengers.
7. The purpose of this machine is to perform work. This equipment is not intended for sport or recreation.
8. Do not mow when people or pets are around.
9. Clear work area of objects (wire, rocks, etc.) which might be picked up and thrown.
10. Take all possible precautions when leaving vehicle unattended, such as disengaging power-take-off, lowering attachments, shifting into neutral, setting parking brake, stopping engine and removing key.
11. Watch out for traffic when crossing or near roadways.
12. Machine and attachments should be stopped and inspected for damage after striking a foreign object. Damage should be repaired before restarting and operating equipment.
13. Do not change engine governor settings or over-speed engine.
14. Wear appropriate protective clothing when operating equipment. Long pants and substantial footwear, not barefoot or open sandals, are essential.
15. Do not operate equipment unless properly seated with feet on footrests or pedals.
16. Keep your eyes and mind on your machine, attachment and the working area. Do not let other interests distract you.
17. Safety switch(es) are intended to stop or prevent starting of engine to help prevent accidents. **OPERATOR SHOULD TAKE PRECAUTIONS AND NOT RELY ENTIRELY ON SAFETY SWITCH(ES).**
18. Care should be used not to touch equipment or attachment parts which may be hot from operation. Muffler and nearby areas may exceed 150° F. Allow cooling to occur before attempting to maintain, adjust or service.
19. Use of stereo headphones, ear protection or other sound altering/dampening devices may limit your ability to hear warning sounds (horns, shouts, etc.).

FUEL/FIRE PRECAUTIONS

20. Handle gasoline with care — it is highly flammable.
21. Use approved gasoline container. Place container out of reach of children.
22. Use gasoline only as a fuel — never as a cleaner.
23. Never remove fuel cap or add gasoline to a running or hot engine, or an engine that has not been allowed to cool for several minutes after running.
24. Never fill fuel tank indoors. Wipe up spilled gasoline.
25. Open doors if engine is run in garage — exhaust fumes are dangerous. Do not run engine indoors.
26. Do not fill machine with gasoline while smoking or when near open flame or sparks.
27. Never store equipment with gasoline in the tank inside a building where fumes may reach an open flame or spark.
28. Allow engine to cool before storing in any enclosure.
29. To reduce fire hazard, keep engine and attachments free of grass, leaves or excessive grease.
30. Battery acid is a poison and can cause burns. Avoid contact with skin, eyes and clothes and protect your face, eyes and clothing when working around the battery.
31. Battery gases can explode. Keep cigarettes, sparks and flames away from battery.

EQUIPMENT USE AND OPERATION

32. It is recommended that first operation of equipment be done at a slow speed with attachment disengaged. Continue this practice until operator is thoroughly familiar with the controls and has developed operating skills.
33. Disengage all attachment clutches, set parking brake and shift into neutral before attempting to start engine.
34. Disengage power to attachment(s), set parking brake and stop engine before leaving operator position.
35. Disengage power to attachment(s) and stop engine before making any repairs or adjustments.
36. Disengage power to attachment(s) when transporting or not in use.
37. Disengage attachment clutch before attempting to remove the mower from a hole or other obstruction.
38. Disengage power to attachment(s) before backing. Do not mow in reverse unless absolutely necessary and then only after careful observation of the entire area behind the machine.
39. **LOOK** behind machine to make sure the area is clear before placing the transmission in reverse and continue looking behind while backing.
40. Always back up loading ramps and tilt bed trailers.

41. The parking brake is designed to hold tractor in place at rest, with engine off. Parking brake **will not** restrain tractor with engine running and transmission engaged.

STABILITY/TIPOVER/TRACTION

42. Know the terrain on which you are operating your equipment. There are areas on which your equipment can not be safely operated.
43. Avoid operating equipment on hillsides, slopes or rough terrain. **DO NOT** operate machine on hillsides or slopes exceeding 15° (27% grade). If safety is in doubt — **STAY OFF THE SLOPE**.
44. Reduce speed and exercise extreme caution on slopes above 10° (18% grade) to prevent tipping or loss of control. Never mow uphill on these slopes — mow downhill only. If a steep hill must be ascended, back up the hill, and drive forward down the hill, keeping tractor in gear. If necessary to turn on hill, always turn downhill.
45. Mow up and down the face of slopes greater than 5° (9% grade), never across the face. Be especially cautious when changing directions on all slopes.
46. Operate your machine smoothly and at a ground speed slow enough to insure complete control at all times. Avoid erratic operation and excessive speed.
47. Sharp turns on any terrain may cause loss of control. Reduce speed and use caution when making sharp turns.
48. Do not stop or start suddenly when going uphill or downhill. Avoid uphill starts. If machine is stopped going up a slope, turn the attachment off and back slowly down the slope keeping the machine in gear. Do not stop or change gears (speed) on slopes.
49. Know the terrain on which you are working. Find hidden obstacles by walking through and inspecting the area prior to operating your equipment in that area. Plainly mark obstacles, such as rocks, ruts or holes and **stay well clear of these obstacles** when operating.
50. While operating, stay alert for holes, rocks or roots, which may cause damage to equipment or upset. Keep at least 3 ft. away from drop-offs, ditches, creeks, culverts, washouts and public highways.
51. Exercise care when mowing around a fixed object to prevent the equipment or attachment from striking the object. When mowing never deliberately run over any foreign object.
52. Areas wet with dew, rain or snow will be more slippery than when dry. Areas covered with loose gravel are more slippery than firm dry ground. Greater stopping distances are required in these slippery areas.
53. Learn to expect changes in operating conditions. Adding or removing attachments or weight to your equipment will make your machine perform differently. Rain, snow, loose gravel, wet grass, etc., change the tractive conditions of the terrain requiring changes in your operating technique, which may include a decision not to operate on that terrain.

54. Use care when pulling loads or using heavy equipment.
 - A. Use only approved drawbar hitch points.
 - B. Limit loads to those you can safely control.
 - C. Do not turn sharply. Use care when backing.
 - D. Use counterweight(s) or wheel weights when suggested in operator's manual.

ATTACHMENT USE

55. When using attachments never direct discharge of material toward bystanders nor allow anyone near vehicle while in operation.
56. When using machine with mower:
 - A. Mow only in daylight or in good artificial light.
 - B. Never make a cutting height adjustment while engine is running if operator must dismount to do so.
 - C. Shut engine off when unclogging chute.
 - D. Check blade mounting bolts for proper tightness at frequent intervals.
57. Keep hands and feet away from rotating blade(s) underneath mower deck. Never place foot on ground when mower is engaged or when mower is in motion.
58. **DO NOT** operate mower attachment without the chute deflector or complete bagger in place.
59. Exercise care while maneuvering with grass catcher. Front to rear stability may change.
60. When using machine with snowthrower and auger becomes plugged or jammed:
 - A. Declutch snowthrower and stop tractor engine immediately.
 - B. Disconnect spark plug wire(s).
 - C. Clear snow from discharge chute if plugged.
 - D. If auger is jammed, remove foreign object and repair any damage to snowthrower before continuing.
 - E. Reconnect spark plug wire(s) and resume operation.
61. Never permit anyone to stand near snowthrower auger or discharge opening. Objects may be present in snow, which when thrown, could cause injury.
62. When using snow/dozer blades:
 - A. Avoid hitting solid objects. This can damage blade and injure operator.
 - B. Always travel at a safe, slow speed.
63. Keep all persons a safe distance away when operating tillers. Always disengage the PTO, lower the attachment and remove the ignition key before making any adjustments.
64. If tiller starts to push tractor, disengage PTO clutch immediately.
65. Use chains, counterweight(s) or wheel weights when suggested in the operator's manual.

MAINTENANCE

66. Keep all nuts, bolts, fasteners and screws tight to be sure equipment is in safe working condition and check them frequently. Repair or replace worn, damaged, distorted or broken parts as needed.

67. Keep vehicle and attachments in good operating condition and keep safety devices in place and working.
68. Under normal usage, grass catcher bag material is subject to deterioration and wear. It should be checked frequently to determine need for bag replacement.
69. Use only genuine Wheel Horse replacement parts to assure that original standards are maintained.
70. Shields, deflectors, switches, blade controls and other safety devices must be in their proper position and functional.
71. Do not operate without muffler or tamper with the exhaust system. Damaged mufflers or spark arresters can create a fire hazard. Periodically inspect and replace if necessary.
72. If equipment begins to vibrate abnormally, disengage power to attachments and stop engine at once. Repair any damage before starting or continuing operation.
73. Periodically inspect all shafts, levers, friction devices and other moving parts subject to wear. Make required adjustment or replace these parts if damaged, distorted or broken, or as soon as wear affects the normal operation of the vehicle or attachment. DO NOT operate equipment that is not functioning properly.

MODEL AND SERIAL NUMBER LOCATIONS

Model and Serial numbers are used to identify your new tractor and major attachments. These numbers should always be referred to when consulting dealer or factory concerning service, parts, or other information you may require. If these plates are removed during repair operations, they should always be replaced.

Tractor model and serial number plate is located just below seat on rear fender.

Engine identification numbers are located on engine shrouding and indicate model, specification or type number and serial number of tractor's engine.

Major attachments also have a model and serial number plate attached to them.

For your convenience and ready reference, enter tractor and engine numbers below.

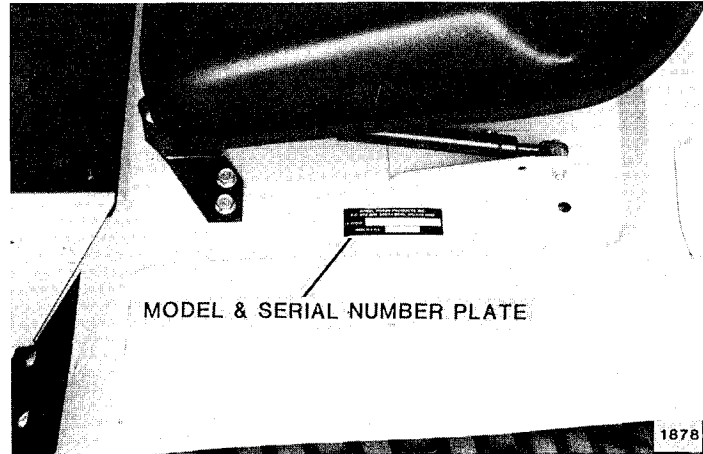

Model and Serial Number Plate Location

Tractor Model and Serial Number

Engine Identification Number

MODEL	
SERIAL	
TORO Wheel Horse 515 WEST IRELAND ROAD SOUTH BEND, INDIANA 46614 USA	

Model _____

Type or Spec. No. _____

Serial Number _____

OWNER REGISTRATION AND WARRANTY

Service and warranty assurance is as important to Toro Wheel Horse as it is to you, the owner. To facilitate warranty service at an Authorized Toro Wheel Horse Dealer, Toro Wheel Horse requires factory registration. A registration card is supplied with each new tractor and attachment. **Either you or your dealer must fill in required information and mail card to Toro Wheel Horse.**

Toro Wheel Horse Limited Warranty Statement is on a "hang tag" attached to each product. This statement describes what items are covered by the Toro Wheel Horse Limited Warranty, your rights and obligations, and procedure to follow to obtain warranty service. Please familiarize yourself with the warranty statement. **All of us at Toro Wheel Horse want you to be satisfied with your Toro Wheel Horse tractor; please don't hesitate to contact us for assistance.**

PARTS MANUAL

A separate parts manual is available for your Toro Wheel Horse equipment. To obtain a parts manual, see ordering information at end of the publication.

BE SURE TO INCLUDE MODEL AND SERIAL NUMBER OF EQUIPMENT.

INSTRUMENTS AND CONTROLS

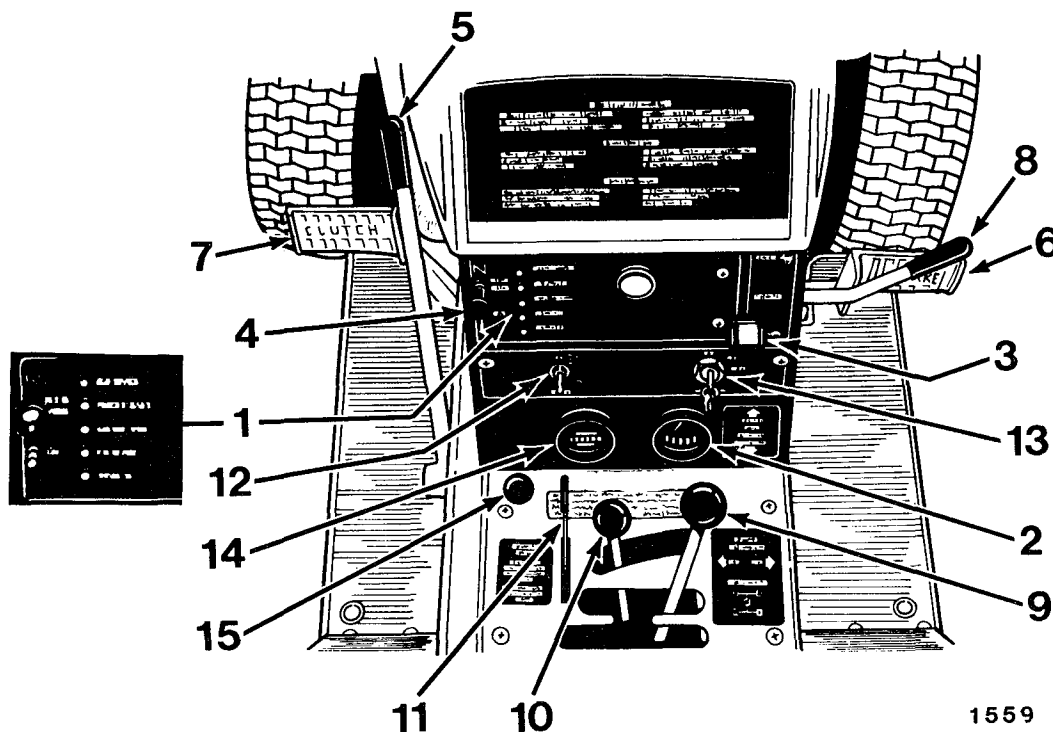

1559

1. INTERLOCK INDICATOR LIGHTS; ENGINE OIL LIGHT

Indicator light test switch is used to check light bulbs and electrical circuits. Push on test switch to turn lights "On" or "Flashing"; if one or more lights are out check wiring and replace circuit board, or bulb assembly on 310, if necessary as outlined in "Maintenance" section of this manual. If PTO clutch or clutch pedal light is on when attempting to start engine, check that control is in proper position for starting. All lights must be OFF During operation; if light(s) is on, a malfunction is indicated in that operation(s) and must be corrected.

2. VOLTMETER

Voltmeter is a gage indicating electrical system battery voltage. With ignition key in Off position, gage is not actuated. When ignition key is turned to On position, gage should read 12 Volts or slightly above. When starter is engaged, gauge reading should not drop below 8 Volts. After engine is started and running, gauge should read between 12 and 16 Volts. If gauge reads less than 12 Volts battery is discharging. If gauge

reads 16 volts or higher for long periods of time, check battery water more frequently.

3. THROTTLE CONTROLS

Throttle control lever controls engine speed. Raise lever to operate tractor; Lower lever before shutting engine off.

4. CHOKE CONTROLS

Pull choke knob out when starting engine. Slowly push knob in after engine starts. If engine is warm and has been running, choking may not be necessary to restart it.

5. MANUAL LIFT

Depress lift lever release button and move lever forward or rearward to lower or raise attachments used with tractor. Always lower attachments before leaving tractor unattended

6. BRAKE PEDAL

Pushing down on brake pedal applies brake. Note: When coming to a stop always depress clutch pedal as well as brake pedal so that transmission will be disconnected from engine.

OPERATING YOUR TRACTOR

SAFETY INTERLOCK SYSTEM

Safety interlock system incorporates two switches for safe starting and a seat switch that shuts off engine when driver raises off seat with PTO engaged.

Starting switches are actuated by left foot pedal and PTO clutch control. If tractor will not start, check that PTO clutch is disengaged and left foot pedal is depressed. Indicator lights will be on (if so equipped) and engine will not start unless both switches are properly actuated.

Safety interlock system must be tested periodically. To test operation, following functions must be observed. If not, immediate repairs must be performed by an Authorized Toro Wheel Horse Dealer for your protection.

1. Engine should NOT start if:
 - a. Left foot pedal is released.
 - b. PTO is engaged.Test each of the above, one at a time.
2. With engine running and PTO engaged, test operate seat switch by raising off seat. Engine should shut off.

SEAT CONTROL

For seat adjustment, loosen bolts under seat, slide seat to desired position and retighten bolts. To move 416-8 seat, push on lever and slide seat to desired position.

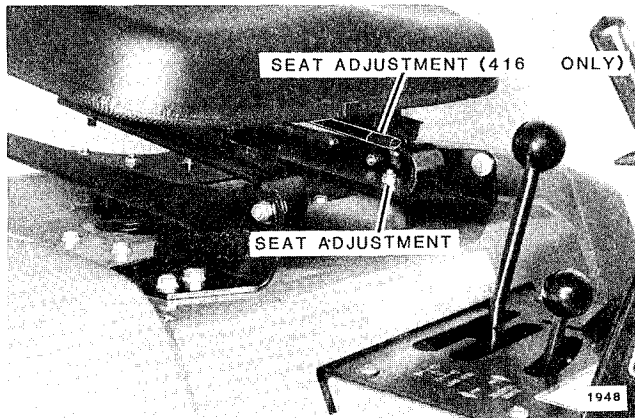

Seat Adjustment

CORRECT ENGINE OPERATION

⚠ CAUTION ⚠

Before starting engine, become familiar with all controls. Read this Operator's Manual thoroughly. Always check engine oil level before starting.

⚠ DANGER ⚠

Care should be taken to avoid inhaling exhaust gases as they contain carbon monoxide gas which is colorless and odorless. Carbon monoxide is a dangerous gas that can cause unconsciousness and is potentially lethal.

Do not run engine in confined areas such as a closed garage.

STARTING ENGINE

Because of a built-in safety interlock system, your tractor will not start until left foot pedal is depressed and PTO is disengaged. If so equipped, indicator light(s) will be on when controls are not in correct position for starting.

To start engine depress left foot pedal and disengage PTO.

310,312 Models: Engines are equipped with a low oil safety switch and will not allow engine to start when oil is low or out. Oil indicator light will be on when oil is low or out and key switch is in start position.

Move throttle control lever about halfway to Operate position. Pull choke control all the way to Cold position.

416 Model: Move Throttle control to low idle position and choke control all the way to Cold position.

⚠ CAUTION ⚠

Mechanical Transmission: Always place transmission gear shift lever in neutral position before attempting to start engine.

Turn ignition key clockwise until starter engages. When engine starts, release key. Switch is spring loaded and will return to Run position automatically.

If engine fails to start after 30 seconds of continuous cranking, turn key to Off position and allow starter motor to cool. Check for cause of hard starting; consult Troubleshooting Checklist.

310,312 Models: Once engine has started, slowly return choke control to Operate position.

416 Model: Once engine has started, raise throttle to halfway position and then move choke to Operate position.

If engine stalls or hesitates during operation, choke should be applied as necessary until engine reaches normal operating temperature.

STOPPING ENGINE

To stop engine, return throttle lever to idle position and turn ignition key to Off position. If engine has been working hard, or is hot, allow engine to idle a short time before turning key off. This practice will help to cool engine before stopping.

Note: In case of emergency, engine may be stopped by turning ignition key to Off position.

⚠ CAUTION ⚠

Always remove key and set parking brake when leaving tractor unattended, even if for just a few minutes. Prevent accidents, do not give children or unauthorized persons an opportunity to operate this machine.

THROTTLE AND CHOKE CONTROL

Throttle control regulates speed of engine as measured in RPM (Revolutions Per Minute). This control should not be

7. CLUTCH PEDAL

Pushing down on clutch pedal does two things:

- (1) Declutches transmission drive belt from engine;
- (2) Actuates a safety interlock switch so starter will operate. Engaging clutch is done by releasing pedal which tightens transmission drive belt. Always release pedal slowly when engaging clutch. Always depress pedal when shifting transmission into or out of gear and when starting engine. Indicator light comes on, if so equipped, with pedal released and ignition key in start position.

8. PTO (POWER TAKE-OFF) CLUTCH LEVER

Power driven attachments are engaged and disengaged with PTO lever. Push lever forward to engage attachment. Pull lever back to disengage attachment. PTO clutch lever actuates a safety interlock switch in starter circuit; therefore, indicator light comes on, if so equipped, and tractor will not start unless lever is in disengaged position. If operator's seat is vacated while PTO is engaged, seat switch indicator light comes on, if so equipped; and seat switch will automatically shut off engine.

9. GEAR SHIFT LEVER

Select any forward or reverse speed by moving lever to position as indicated on shift pattern decal.

10. RANGE SELECTOR

Select either high or low range by moving range selector lever right or left to position as indicated on range selector decal. Low range provides a 4 to 1 speed reduction and greater pulling power for moving heavy loads in any forward or reverse speed. Do not use a mid-point position for neutral. Neutral must be selected with gear shift lever.

11. PARKING BRAKE LOCK LEVER

Parking brake lever is located in front of seat on left side of frame. To engage parking brake, first apply foot brake pedal solidly and then move parking brake lock lever back to lock brake. To release parking brake push down on brake pedal. Parking brake lock lever is spring loaded and will return to disengaged position when foot brake is applied. Indicator light is on, if so equipped, when parking brake is locked with engine running.

12. LIGHT SWITCH

Raise toggle to turn lights on. Lower toggle to turn lights off. Lights will work only when ignition switch is in Run position.

13. IGNITION SWITCH

Ignition switch has three positions from left to right:

(1) Off, (2) Run, (3) Start. To start engine turn key all the way right to Start position. Release key when engine starts and it will automatically return to Run position. When switch is turned to Off position, engine stops and all electrical accessories are turned off.

14. HOUR METER

Hour meter is a gage indicating operated hours of tractor.

15. DIAL-A-Height

Dial-A-Height control is used to hold an attachment (other than a mower) at a desired height above ground. Turn knob left or right to limit forward travel of lift lever. Turn knob all the way left for mower operation.

16. FUEL SHUT-OFF VALVE (Not Shown)

Fuel shut-off valve is located on bottom of fuel tank. Fuel shut-off valve is normally left open, except when service on fuel system becomes necessary.

used to regulate ground speed of tractor.

The engine in your new Toro Wheel Horse has been designed with a special governor that limits maximum RPM. The governor allows engine to operate most efficiently at a set speed, and protects it from damage caused by excessive RPM. Always operate tractor with throttle control set at full speed.

Engine MUST be operating at full throttle whenever tractor is in use. Use of tractor while engine is operating at less than full throttle may result in poor overall tractor performance.

Choke control activates a "butterfly" valve in carburetor. When choke is partially or completely closed, less air is admitted to engine. This results in a higher fuel-to-air (richer) mixture that is easier to ignite when engine is started cold. Warmer engines may not need choking.

FUEL SPECIFICATION

⚠ DANGER ⚠
Handle fuel with care - It is highly flammable. Use only approved fuel container. Never add fuel while engine is running. Fill fuel tank outdoors with extreme care. Never fill fuel tank indoors. Replace gasoline cap securely and wipe up all spilled fuel.

Use clean, unleaded gasoline (85 octane minimum). Regular leaded gasoline may also be used but it is not a preferred fuel. Do not use highly leaded premium gasoline. Use of unleaded gasoline results in less maintenance.

⚠ CAUTION ⚠
Do not use gasoline de-icers. Gasoline de-icers can cause internal damage to carburetor and fuel pump parts. Do not use fuels containing alcohol concentrations greater than ten percent. Fuel containing alcohol may cause poor engine performance and internal engine damage.

If regular leaded gasoline is used continually, carbon and lead deposits should be removed from the cylinder heads as required because of engine power loss. Unleaded gasoline may be used safely after lead deposits have been removed.

OIL SPECIFICATION

To protect your tractor's engine, check oil level before each use. On 310 and 312 models, engine is equipped with a low oil safety switch and will not allow engine to start when oil is low or out and key switch is in "On" position.

Complete information concerning recommended oils and how to check oil level is given in "Maintaining Your Tractor" section of this manual.

CORRECT MECHANICAL TRANSMISSION OPERATION

To Go Forward Or Reverse

With engine running, depress both clutch and brake

pedals. Move range selector to either High or Low position. Move gear shift lever to desired speed forward, or to reverse. Gear shift decal identifies various speeds. Release brake pedal. Slowly release clutch pedal. As clutch pedal is released, tractor will begin to move.

⚠ CAUTION ⚠
Always release clutch pedal slowly when starting tractor in motion. Sudden starts can be damaging to equipment and could cause loss of operator control.

To Change Speeds Or Direction

When a change in ground speed or direction is required, always bring tractor to a complete halt by depressing both clutch and brake pedals.

Never attempt to shift gears with unit in motion. Severe internal transmission damage may result.

Change gear shift lever or range selector as desired. Approximate ground speed for each gear is shown in Specifications Section in front of this manual.

It is not necessary or recommended to shift "up" or "down" through gears with tractor in motion. Tractor has sufficient power to move out in a selected gear. With a heavy load attached, a lower gear should be used.

To Stop

To stop tractor, depress clutch pedal then brake pedal. Clutch pedal must be depressed fully before brake pedal is depressed.

⚠ CAUTION ⚠
When stopping tractor always depress clutch pedal first, then brake pedal. Depressing brake without clutch may cause excessive brake lining wear, or extensive internal transmission damage. Depressing clutch pedal without depressing brake pedal WILL NOT STOP TRACTOR.

CORRECT TRACTOR USAGE

⚠ CAUTION ⚠

Read manuals provided with attachments before operating. Manuals give a more detailed description of operation and point out other areas of caution. Familiarize yourself thoroughly with equipment before attempting to use it.

ATTACHMENT MOUNTING

Hitches

Attach-a-matic front and mid hitches are provided for easy installation and removal of attachments without tools.

Rear mounted attachments are secured to tractor's rear drawbar hitch, or to a special hitch supplied with attachment or available as optional equipment.

To install attachments make sure hitch latches are in released position - to do this, push in on lock release pin; move latch lever or handle so latch is open and release lock pin to hold latch in open position. Insert and center attachment shaft in hitch slots and move latch toward closed position until release pin snaps outward.

Removal of attachment is done by pushing in on lock release pin, which allows latch to be moved to open position.

Note: For specific installation and removal instructions refer to attachment instructions.

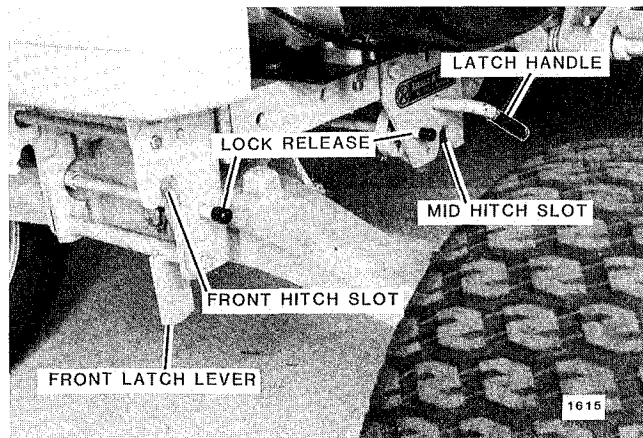

Front and Mid Attachment Hitches

ATTACHMENT BELTS

1. Remove hairpin cotter from trunnion and remove trunnion out of top plate.
2. Remove clevis pin from clutch shaft and clevis.
3. Move top plate forward and remove large hairpin cotter at bottom of rod housing. Slide rod housing down and out of top plate. Swing rod housing to front or rear.
4. Refer to applicable Operator's Manual to determine PTO clutch belt routing. Install belt in inner groove of PTO

pulley for mower and tiller. Install belt in outer groove for Snowthrower, Lawn Vac, Generator and Loader.

5. Move top plate forward, insert top end of rod housing in hole in top plate and install large hairpin cotter in bottom of rod housing. Move top plate rearward. Line up clevis with hole in clutch shaft and install clevis pin.

6. Insert trunnion in top plate and secure with hairpin cotter.

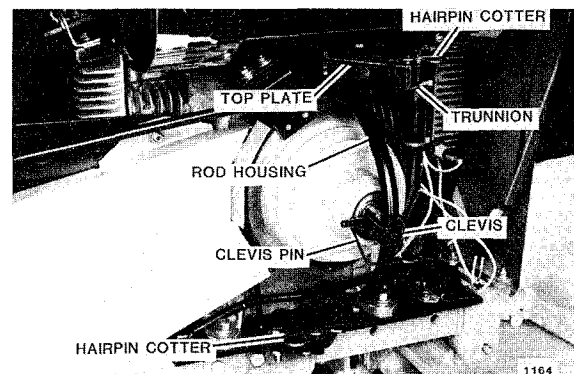

Power Take-Off (PTO)

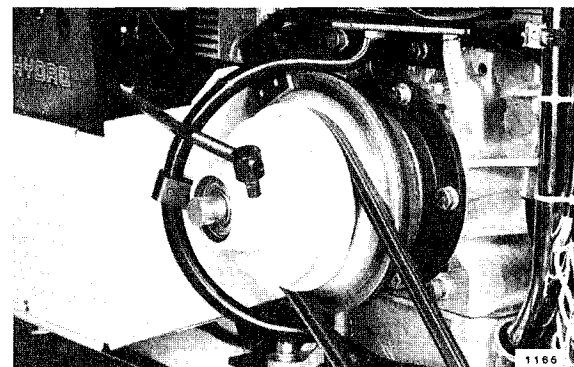

Belt Routing - Both belt strands OUTSIDE Rod Housing

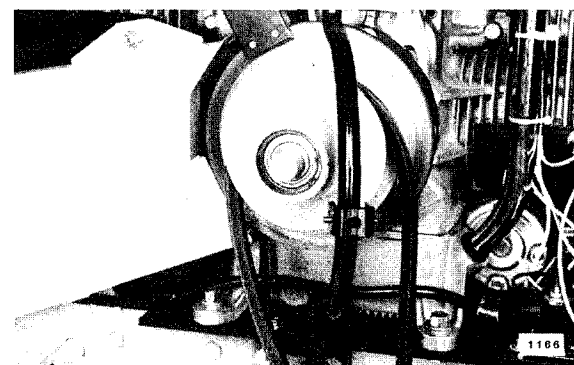

Belt Routing - One belt strand OUTSIDE, one INSIDE of rod housing

OPERATION OF TRACTOR

Because of sufficient tractor engine power no problems should be encountered using attachments under normal conditions. On rough, hilly, or wet terrain, addition of wheel

weights and tire chains will minimize rear tire slippage. All tires may be fluid filled.

WITH A MOWER

⚠ DANGER ⚠
Keep all shields and mower discharge chute in place. Never put hands or feet under mower deck. Never attempt to clear discharge areas or mower blades without disengaging PTO clutch and removing ignition key.

For best operation on average lawns, operate engine at full throttle while controlling ground speed with transmission. Tractor should be operated at 2 to 3.5 MPH (3.2 to 5.6 kmh)* while mowing grass. Uneven cutting is often a result of excessive ground speed. To correct, reduce ground speed with transmission. Average lawns are usually cut at a height between 2 and 3 in. (5-7.6 cm). Tall grass and weeds should be cut with mower in its highest position, making a second pass cutting at height desired.

Always keep mower blades sharp.

⚠ DANGER ⚠
Sharp edges of mower blades can cut you during blade maintenance or adjustment. Use suitable covering over cutting edges of blade to prevent bodily harm.

WITH A SNOWTHROWER

⚠ CAUTION ⚠
Thoroughly inspect area where snowthrower is to be used. Remove all door mats, sids, boards and other foreign objects. Never make any adjustments while engine is running. Never try to clear chute while engine is running.

Snow removal will vary greatly with condition of each snowfall. Light fluffy snow will be cleared with ease. Heavy wet snow will be more difficult. It is advisable to coat auger and chute with a light coat of wax or paraffin to keep snow from sticking. Best results are usually attained when tractor ground speed is set at 1 to 2 MPH (1.6 to 3.2 kmh).*

NOTE: Inflate front tires to 20 P.S.I. for use with two stage snowthrower.

Care should be exercised whenever snow thrower is engaged. Auger is capable of picking up sticks, stones and other foreign objects and expelling them with great velocity. Always aim discharge chute away from persons or objects subject to harm.

Tire chains and wheel weights are recommended when using a snowthrower.

WITH A SNOW, DOZER OR GRADER BLADE

Although front end dozer blade is generally used for snow removal, it can also be used for moving dirt, sand or gravel.

Care should be taken and a slow ground speed should be maintained whenever blade is used. Impact with a solid object may result in injury to operator and/or damage to blade.

Grader blades are generally preferred for leveling sand, dirt or gravel. Operation of these blades is similar to that of a dozer blade. Rear mount grader blades may require special hitches; consult your dealer for proper hitch(es) required for your tractor.

Front wheel weights may be used to increase front wheel traction. Rear wheel weights and tire chains may also be used to increase rear wheel traction.

WITH A TILLER

Tiller does an excellent job of preparing gardens for planting.

Caution should be exercised when tilling virgin ground or clay as tiller may have a tendency to push tractor. This can be corrected by raising tiller with attachment lift so tiller penetrates only very top of soil. Tiller can be lowered to its full depth on following passes.

⚠ CAUTION ⚠
If tiller starts to push tractor, shut tiller off immediately by disengaging PTO clutch.

Rear wheel weights and cleat tires or tire chains will reduce pushing effect of tiller. Front weights may be used to help improve steering control.

Slowing tractor's ground speed will improve aggressive action of tiller. Best results are usually attained when tractor ground speed is set at less than 1.0 MPH (1.6 kmh).*

Do not over-till soil. Soil tilled excessively will not hold water, and will compact easily.

WITH A PLOW, DISC, CULTIVATOR, OR HARROW

Plows and disc require maximum tractor efficiency. Cleat tires, or tire chains, as well as wheel weights increase rear tire traction. Front wheel weights add to steering control of tractor.

Some of these attachments require special rear hitches. Consult your dealer for proper hitch(es) required for your tractor.

There are two methods of preparing a seed bed for planting.

1. Use a tiller, which will prepare soil in one operation.
2. Use a plow to turn ground, a disc to break up large clumps, and a harrow to pulverize and smooth soil.

Plows are classified by width of furrow they will turn. Generally, plows are set to cut 4 to 6 in. (10-15.2 cm) deep.

A disc is used immediately after plowing. Disc will break large clumps of soil.

*Average walking speed is 3.5 MPH (4 kmh).

After discing, generally, a spike tooth harrow helps pulverize soil and levels seed bed. Soil should now be ready for planting.

Cultivator is used during growing season to help remove unwanted weeds, and to help aerate plant roots. Generally, width of cultivator is taken into consideration before planting seed bed to insure cultivator fitting between rows without damaging crop roots.

WITH A REAR BAGGER

Optional rear mount grass catcher can affect way tractor is operated. Because of added weight of bagger and extra power required, operate tractor in a lower transmission gear.

⚠ CAUTION ⚠
Exercise care while maneuvering with grass catcher. Front to rear stability could be adversely affected.

Under normal usage, grass catcher bag material is subject to deterioration and wear. It should be checked frequently for bag replacement.

WITH OTHER ATTACHMENTS

There are numerous other special-purpose attachments available, which greatly increase tractor's versatility. Attach-

ment can be a completely self-contained system (front bucket loader), one that is used along with another attachment (lawn vacuum), or one intended for operator comfort (snow cab). These attachments are custom designed for a particular tractor model, but many others simply use tractor as a towing vehicle. They are attached or removed from tractor by installation or removal of a single drawbar hitch pin. Some of these attachments are powered by a separate gasoline engine, some are ground driven and some are simply towed, such as a dump cart.

In any case, all these attachments should be approached with same amount of caution given any mechanical device. Always read each Operating Instruction Manual carefully before attempting to use attachment. Keep children and pets away from vehicle when in operation. Never allow any unauthorized personnel to operate equipment.

Your authorized Toro Wheel Horse Dealer can assist you with selecting attachments for use with your tractor.

DUMP CART LOAD LIMIT

Toro Wheel Horse recommends following load limit be observed when using tractor with a dump cart on slopes. Load limit has been set to provide for safe braking on slopes.

275 lbs. (127 kg)

MAINTENANCE

⚠ DANGER ⚠

To minimize chance of injury, perform all maintenance and adjustments on your tractor with engine off and ignition key removed, unless instructed otherwise in this section. Use extreme care when working near operating machinery. Do not wear loose fitting clothing. Remove watch and jewelry before beginning work and observe common safety practices when using tools.

MAINTENANCE CHECKLIST

NOTE: These service intervals are considered MAXIMUM under normal conditions. Increase frequency under extremely dirty or dusty conditions.	Before Each Use	After Each Use	Every 25 Hours	Every 50 Hours	Every 100 Hours/1 Year(2)	Every 200 Hours/1 Year(2)	Every 1000 Hours
SERVICE OPERATION							
CHECK:							
Safety Interlock System	X						
Engine Oil Level	X						
Battery Water Level				X			
8 Spd. Trans. Oil Level			X				
General Unit Condition	X	X					
Parking Brake Adj.					X		
Tire Pressure			X				
Fasteners Placed & Tight			X				
PTO Clutch & Brake Adjustment					X		
CLEAN:							
Air Filter/Precleaner			X				
Engine Chaff Screen	X						
Engine Exterior & Fins				X			
Breather Valve(3)						X	
Cylinder Head Deposits							X
REPLACE:							
Engine Oil Filter (3)					X		
Spark Plugs					X		
Air Filter (3)						X	
Air Filter (4)					X		
LUBRICATE:							
Fuel Filter (3)					X		
Chassis			X				
CHANGE:							
Engine Oil (1) (3)				X			
Engine Oil (1) (4)			X				
Engine Oil Filter (3)				X			

Refer to Engine Service Manual for Applicable Information Concerning:

- Adjustments
- Special Cleaning Instructions

- (1) Refer to text for initial service interval for new tractors.
- (2) Which ever occurs first.
- (3) 416
- (4) 310,312

ENGINE

Cooling

Check chaff screen and rotating screen behind chaff screen on engine every time tractor is used. Restricted air flow through engine can cause overheating and engine damage.

Oil Quality

For maximum engine protection under all operating conditions use API Service Classification SF oil. This letter will appear on oil can.

Oil Level

Form a habit of checking oil level regularly.

Check oil level of engine every 8 hours or before each use. An improper oil level can cause extensive internal damage to engine.

Oil filler dipstick and oil drain location for engine is illustrated in following illustrations.

To check engine oil level, stop tractor where engine is level. Shut off engine, set parking brake, and remove ignition key.

⚠ DANGER ⚠

416 Model crankcase pressure can blow out hot oil and cause serious burns. Do NOT check oil while engine is operating.

Remove oil dipstick from engine.

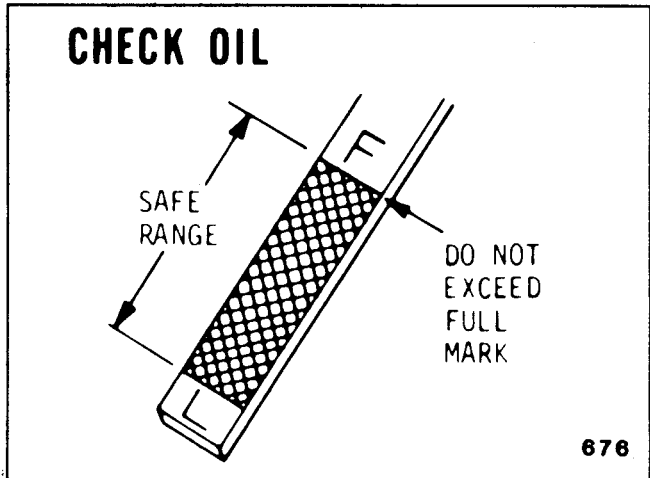

Correct Oil Level

Wipe dipstick with a clean lint free rag; reinstall dipstick into block all the way. Remove dipstick again and read scale on lower portion of stick.

Add oil through oil dipstick tube.

⚠ CAUTION ⚠

Do not overfill crankcase. Excess oil causes high oil consumption and oil accumulation in air cleaner housing.

Be sure to add same viscosity oil as is presently in engine. New tractors are shipped with 10W-30 oil in crankcase. It may be necessary to change original oil before using tractor in cold weather.

Oil Changes

Failure to change engine oil at recommended intervals can lead to serious damage to engine. This is especially true when using detergent oils which are designed to hold impurities in suspension; when saturation point is reached, oil may suddenly break down to form a gelatin-like substance which seriously impairs and can even stop flow of oil. Increase frequency of oil and oil filter changes if tractor is operated under extremely dusty conditions.

On 310,312 Model engines, oil should be changed after first 2 hours of operation. Thereafter, oil should be changed at 25 operating hour intervals. If operating conditions are extremely dusty or dirty, frequency of oil changes should be increased. Oil Sensor Switch should be tested at 500 Hr. oil change interval. To test switch, drain oil and disconnect spark plug. Engine should not crank and indicator light should be ON with key in start position. If engine cranks, consult your dealer for service.

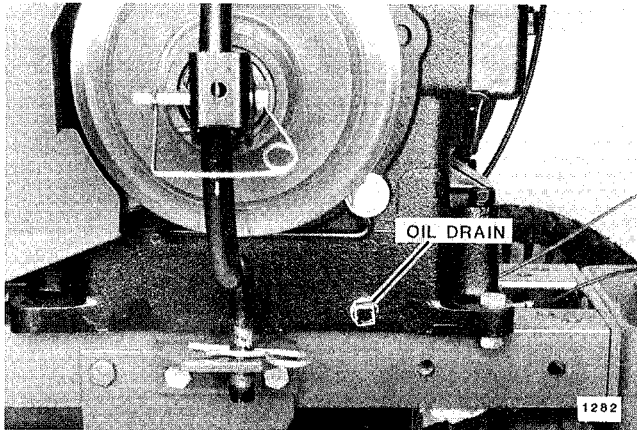

310,312 Oil Drain

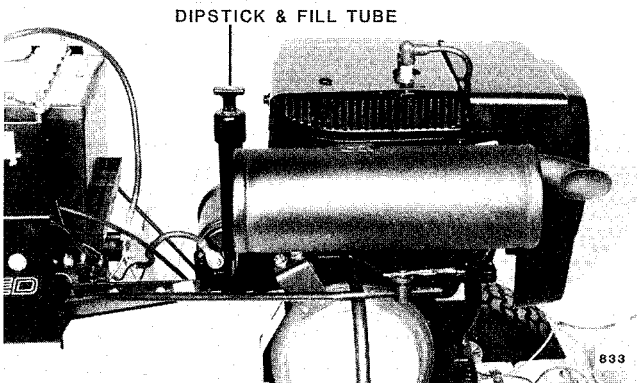

310,312 Oil Dipstick/Fill Tube

On 416 Model engine, oil should be changed after first 25 hours of operation. Thereafter, oil should be changed at 50 operating hour intervals. Oil filter should be changed every 100 hours. If operating conditions are extremely dusty or dirty frequency of oil changes should be increased.

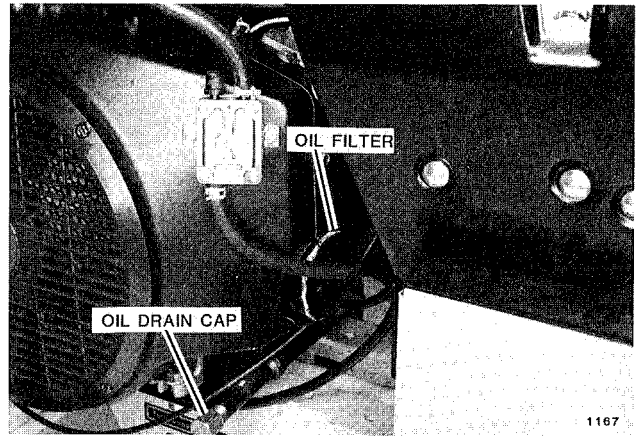

416 Engine Oil Filter and Drain Cap

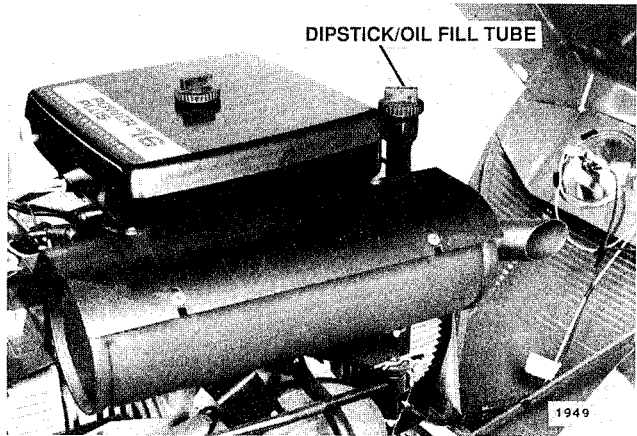

416 Engine Oil Dipstick/Fill Tube

Before changing oil, start engine and allow it to warm up. This will allow oil to flow more freely. Shut engine off and remove key.

Open oil drain. After oil has drained completely, reinstall drain plug or cap.

If oil filter, on engines so equipped, is to be replaced unscrew used filter and install new filter on engine.

Remove oil dipstick and add about 80% of amount of oil specified in following charts. Also shown are charts for selecting correct oil type and oil viscosity. When using temperature-viscosity charts, select air temperature most likely to be encountered within next recommended oil change period.

ENGINE OIL CHANGE

Tractor Model	Crankcase Oil Capacity
310,312	2 1/2 quarts (2.3 liters)
416	1.5 quarts (1.4 liters) w/o Filter 1.7 quarts (1.6 liters) w/Filter

ENGINE OIL TYPE

Engine

Kohler -- API Service SF
TORO POWER PLUS-- API Service SF or SF/CC

ENGINE OIL TEMPERATURE - VISCOSITY CHART

Kohler Engine

Air Temperature

Oil Viscosity

Above 32 degrees F (0 degrees C)

SAE 30

Below 32 degrees F (0 degrees C) SAE 5W-20, 5W-30

TORO POWER PLUS Engine

USE THESE SAE VISCOSITY GRADES

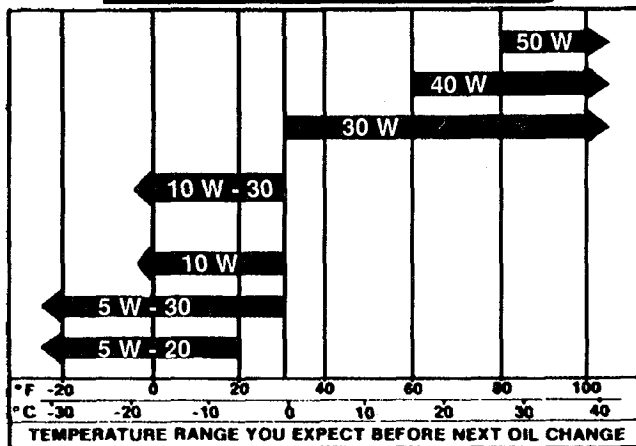

After adding 80% of prescribed amount of oil, check oil level. Add oil as necessary to bring oil to "Full" level or into "Safe" range on engine oil dipstick.

NEVER overfill engine crankcase with oil. Oil level must not exceed "F" level on dipstick.

Air Filter (310,312 - Models)

Dirt induced through improperly installed, poorly serviced, or inadequate air filter elements, is more often cause of a worn out engine than long hours of operation. A small amount of dirt will destroy a set of piston rings in a matter of hours. A clogged element causes a richer fuel mixture which wastes gasoline, and may lead to forming harmful sludge deposits.

Clean engine air filter after every 25 hours of operation (more often if tractor is operated under extremely dusty conditions).

Replace dry type filter elements at 100 hour intervals, or once a year, whichever comes first. Foam type elements may be serviceable for more than 100 hours or one year of operation, provided element shows no sign of deterioration and can still be cleaned satisfactorily. As with cleaning filter, replacement intervals must be shortened when operating under extremely dusty conditions. To protect engine, use only manufacturer's replacement filter, or replacement filters with equivalent specifications.

Check following when installing a new or serviced element:

1. Back plate must be securely tightened to carburetor. Replace back plate if bent or cracked.
2. Gasket surfaces of element must be flat against back plate and cover to seal effectively.

3. Wing nut(s) must be finger tight - **don't overtighten**. Tighten screws securely.

4. Be sure cover seals and gaskets, where used, are in good condition and will seal properly. Bad gaskets and seals can let unfiltered air into carburetor.

To prevent any dirt or other contaminants from entering engine, always cover carburetor air horn when air cleaner is removed.

Dry type air filter element is cleaned by tapping it lightly on a flat surface to remove loose dirt particles. Replace element if dirt does not drop off easily. **DO NOT** wash elements in liquid. Do not attempt to blow dirt off with compressed air as this can puncture filter element.

Foam precleaners are used over filter elements on some engines. Clean precleaner at 25 hour intervals, when air cleaner is serviced. Wash precleaner in a solution of liquid dish washing detergent and water. Squeeze out excess oil and install precleaner on element.

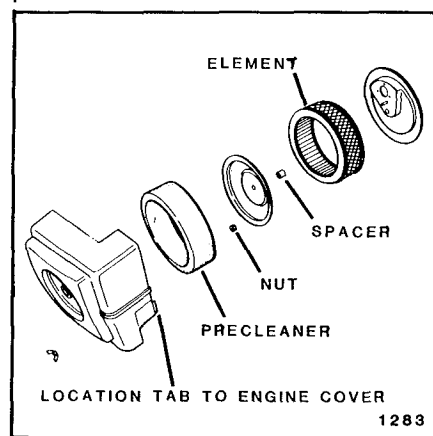

Air Cleaner

Air Filter (416-Model)

Dirt induced through improperly installed, poorly serviced, or inadequate air filter elements, is more often cause of a worn out engine than long hours of operation. A small amount of dirt will destroy a set of piston rings in a matter of hours. A clogged element causes a richer fuel mixture which wastes gasoline, and may lead to formation of harmful sludge deposits.

Replace filter elements at 200 hour intervals. Replace more frequently in dusty operating conditions. To protect your engine, use only manufacturer's replacement filter, or replacement filters with equivalent specifications.

Check following when installing a new or serviced element:

1. Base must be securely tightened to carburetor. Replace base if bent or cracked.
2. Gasket surfaces of element must be flat against base and cover to seal effectively.
3. Tighten screws securely.
4. Be sure cover seals and gaskets are in good condition and will seal properly. Bad gaskets and seals can let unfiltered air into carburetor.

To prevent any dirt or other contaminants from entering engine, always cover carburetor air horn when air cleaner is removed.

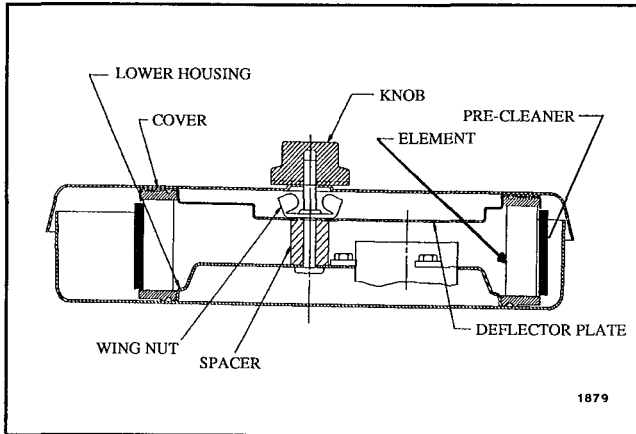

Air Cleaner Assembly

Dry type air filter element is cleaned by tapping it lightly on a flat surface to remove loose dirt particles. Replace element if dirt does not drop off easily. Do not wash elements in liquid. Do not attempt to blow dirt off with compressed air as this can puncture filter element.

Foam precleaners are used over filter elements on engine. Clean precleaner at 50 hour intervals, when air cleaner is serviced. Wash precleaner in a solution of liquid dish washing detergent and water. Squeeze out excess water and allow it to dry. Coat precleaner evenly with two tablespoons of SAE 30 engine oil. Knead into and wiring out excess oil from pre-cleaner. Install precleaner over air cleaner element.

1. WASH
2. SQUEEZE DRY
3. COAT WITH OIL - WRING OUT EXCESS
4. INSTALL OVER PAPER ELEMENT

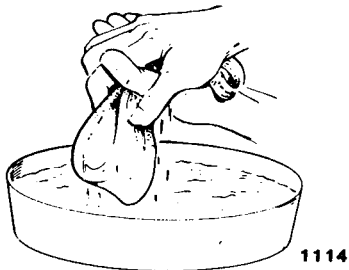

Pre-Cleaner Service

Crankcase Breather (416 - Model)

A crankcase breather valve is used for maintaining crankcase vacuum. If crankcase becomes pressurized as evidenced by oil leaks at seals, clean baffle pack and valve in a suitable solvent. Check and clean valve and baffle every 200 hours of operation.

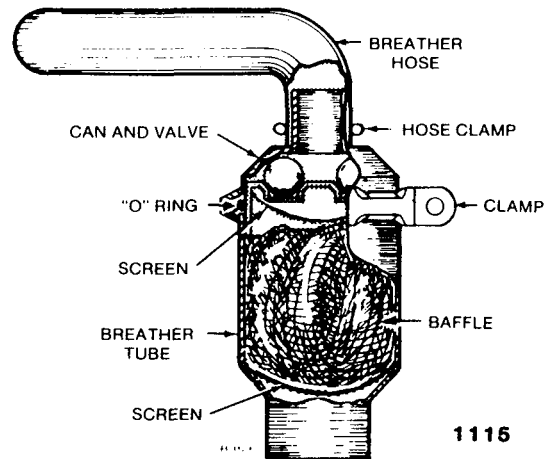

Crankcase Breather

Spark Plug(s)

Engine misfire, or generally poor operation, is often caused by spark plug(s) in poor condition or with incorrect spark gap setting. Spark plug(s) should be replaced after each 100 hours of operation. Replace a spark plug if inspection reveals fouling or excessive deterioration.

Always clean area around spark plug(s) before removing them to prevent dirt from entering engine. Use a spark plug wrench to remove and install plugs.

Check condition of plug(s). Good operating conditions are indicated by a light coating of gray or tan deposit. A dead white, blistered coating could indicate engine overheating. A black coating could indicate an "overrich" fuel mixture caused by a clogged air cleaner, or improper carburetor adjustment.

Replace spark plug(s) that are not in good condition. **Never sandblast, wire brush, scrape or otherwise service a spark plug in poor condition. Best results are obtained with a new plug.**

Always check spark plug gap before installing new plug(s) or reinstalling original plug(s). Use a spark plug gap gauge to adjust electrode air gap to specification for engine.

Tractor Model
All Models

Plug Gap
.025 in. (.6 mm)

Tighten spark plug(s) to:
All Models - 15 ft. lbs. (20 nm)

Electronic Ignition

Breakerless electronic ignition system requires no periodic maintenance.

Fuel System

On 310,312 models, a fine-mesh screen type strainer is incorporated into fitting at bottom of fuel tank, which filters foreign matter from gasoline before it reaches carburetor. This strainer normally requires service only if fuel supply becomes severely contaminated.

On 416 model, engines have an in-line fuel filter located near carburetor. This filter should be replaced after each 100 hours of operation or at 1 year intervals, whichever occurs first.

Always clean area around fuel cap before removing it to prevent excessive amounts of dirt from entering fuel system. Also insure that fuel storage container you are using is clean and in good condition.

Fuel filter gives only limited protection against moisture in fuel system. Keep fuel tank full during winter operation, when cold and damp weather conditions can cause moisture to condense in tank.

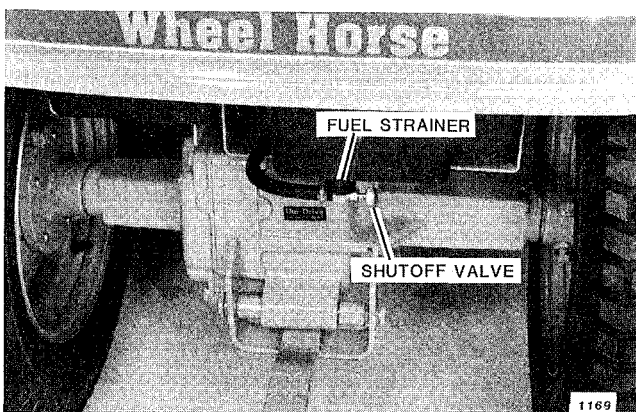

Fuel Strainer



416-Model Fuel Filter

Carburetor Adjustment

Carburetor is adjusted at factory and should not have to be reset. If a condition is noted as outlined in following "Carburetor Adjustment Chart", carburetor should be readjusted immediately. Continued operation with incorrect carburetor settings can lead to a fouled spark plug, overheating, excessive valve wear or other problems. If black exhaust smoke is noted, check air cleaner element first - an "overrich" mixture is usually caused by a poorly serviced, clogged air cleaner element, not an improperly adjusted carburetor.

Correct carburetor adjustment requires a significant amount of knowledge as well as special equipment, such as a good tachometer. In addition, other adjustments, such as governor settings, may also be necessary after adjusting carburetor. For these reasons, it is suggested that carburetor adjustments be performed by an authorized dealer.

CONDITION
A. Black, sooty exhaust smoke, engine sluggish.
B. Engine misses and backfires at high speed.
C. Engine starts, sputters and dies under cold weather starting.
D. Engine runs rough or stalls at idle speed.

POSSIBLE CAUSE/PROBABLE REMEDY
A. Mixture too rich - readjust idle or main fuel needle.
B. Mixture too lean - readjust idle or main fuel needle.
C. Mixture too lean - readjust idle or main fuel needle.
D. Idle speed too low or improper idle adjustment - readjust speed then idle fuel needle if needed.

Carburetor Adjustment Chart

CHARGING AND ELECTRICAL SYSTEMS

Alternator

An alternator is used to charge battery. Alternator charging system normally requires no service other than periodically checking all exposed wiring and electrical connections on tractor are clean, tight and in good condition. **On 416 Model only**, a 30 amp automotive type ATO or ATC fuse is used to protect charging circuit.

⚠ CAUTION ⚠

Proper polarity is critical with an alternator equipped charging system. Always disconnect battery ground cable (negative) before working on any part of electrical system. Verify all components are connected correctly before reconnecting ground cable (negative) or damage to alternator system components will result.

Never run engine if battery is removed, or if battery is not connected to charging system. Serious damage to voltmeter, circuit board and charging system components may result.

Main Fuse

A 25 amp automotive type ATO or ATC fuse is used to protect main circuit of electrical system.

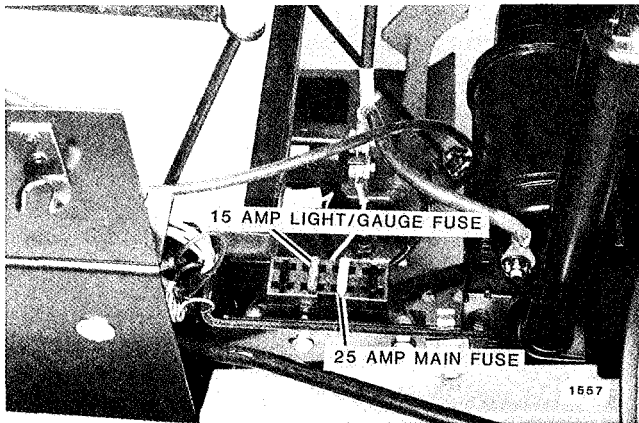

310,312 - Model Fuse Location

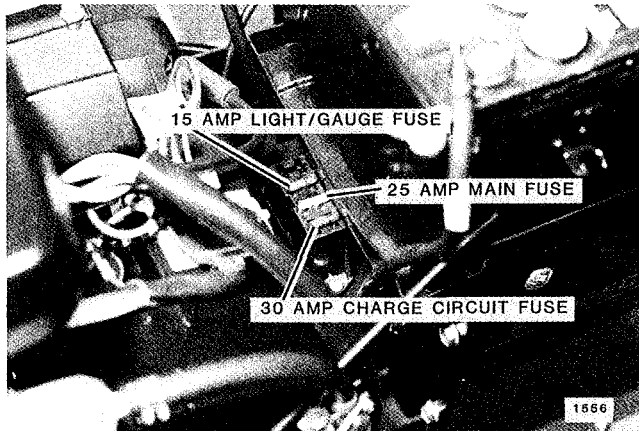

416 - Model Fuse Location

Light Circuit Fuse

Light circuit is powered by battery. Lights will operate when ignition switch is in "Run" position. A 15 amp automotive type ATO or ATC fuse is part of light circuit.

Gage Circuit Fuse

Gage circuits are protected by light circuit 15 amp automotive type ATO or ATC fuse.

Battery

⚠ CAUTION ⚠

When servicing battery or any other part of electrical system, or if battery must be removed for any reason, always disconnect negative (ground cable) **FIRST** and reconnect it **LAST** to avoid possibility of electrical shorts.

This paragraph does not pertain to a "Maintenance Free Battery." Maintain electrolyte level above plates in each cell

by adding distilled water as necessary. Best time to add water is just prior to operating tractor so water will mix with solution. Do not overfill battery. Electrolyte solution is corrosive and overfilling can cause damage to surrounding metal parts. Battery should be maintained a 1.265 specific gravity charge. When battery has been out of tractor for servicing, take care to connect cables to battery exactly as they were before removal.

For longest service life, battery should be kept clean by wiping it off with a paper towel. Any corrosion around battery terminals should be removed by applying a solution of one part baking soda to four parts water. A light coating of grease may be applied to all exposed terminal surfaces to prevent corrosion.

At temperatures below 32 degrees F (0 degrees C), full charge state must be maintained to prevent cell electrolyte from freezing and causing permanent battery damage.

Light Bulb Replacement

Headlight and tail light bulbs (on models so equipped) are replaced as described below. Care should be taken when handling bulbs, particularly if they are broken.

Either sealed beam headlamp unit is replaced by first disconnecting both terminal wires. Note way headlamp is installed, then carefully remove bolt and retainer to release headlamp.

To replace a tail light bulb, pry lens off with a screwdriver. A slot is located at each end of lens for this purpose. If bulb has a metal socket, push bulb down and turn counterclockwise to remove it. If bulb has a plastic socket, simply pull bulb straight out. Tail light bulbs are automotive #1895 (metal base) or #194 (all glass).

To replace indicator light bulb, consult your authorized Toro Wheel Horse Dealer.

8-SPEED TRANSMISSION

Oil Quality

Mechanical transmission in your new Toro Wheel Horse Tractor is filled with gear oil. Same type oil must be used whenever transmission needs filling.

Transmission	Oil	Capacity
8-Speed	SAE 90 API Service GL-5	2 qt. (1.9 Liter)

Oil Level

Lubricant level should be checked after every 25 hours of operation. Changing lubricant is not required except for major service. To check lubricant level remove dipstick from transmission case. Maintain oil at "full" level on dipstick.

Use care to prevent dirt, clippings or other foreign material from entering transmission during oil level checks, oil fillings, or oil changes.

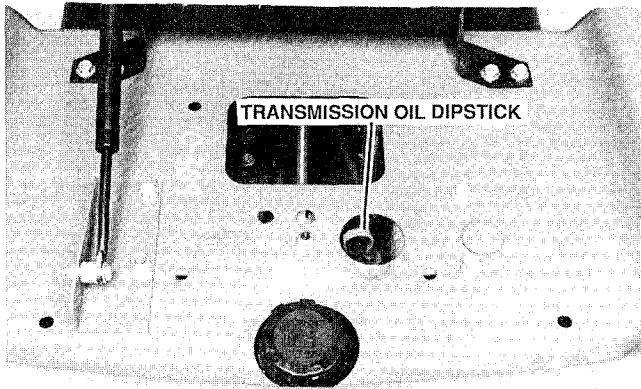

8-Speed Transmission Dipstick

CHASSIS LUBRICATION

Steering gear, brake pedal, clutch pedal, spindles, front wheel bearings and front axle pivot are equipped with fittings to facilitate lubrication with a pressure grease gun. Before applying grease gun, clean zerk fittings carefully to prevent dirt from being forced into fitting. After inserting grease, wipe off any excess grease. A general purpose grease (lithium base) is used to lubricate tractor.

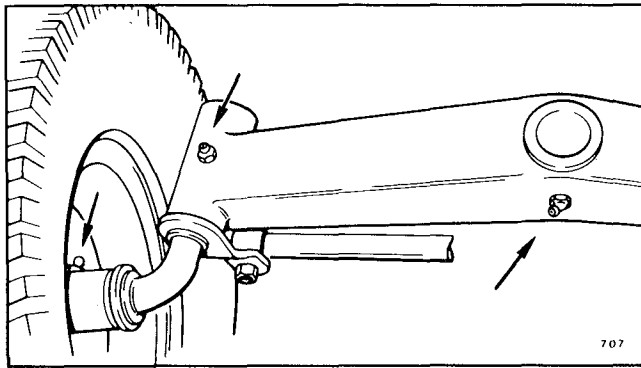

Front Wheel, Spindle and Front Axle Lube Fittings

Lubricate chassis after each 25 hours of operation. All other pivoting arms and levers should be lubricated at same intervals with either general purpose grease or machine oil, applied directly to wear surfaces.

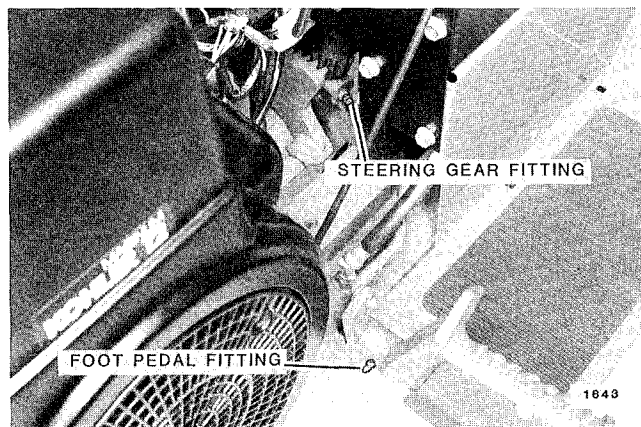

Steering Gear and Foot Pedals Lube Fittings

FOOT BRAKE ADJUSTMENT

Brake band, located on left side of transmission, brakes transmission shafts and, in turn, brakes rear wheels.

To adjust brake push down on brake pedal and pull back on parking brake lever. With parking brake engaged, adjust nut on end of rod until brake band is tight enough to skid both rear wheels when tractor is pushed. Then tighten nut another 1/2 turn. After adjustment, parking brake lever should not travel to end of lever's slot when parking brake is engaged. With brake released, brake band should not "drag" on brake drum.

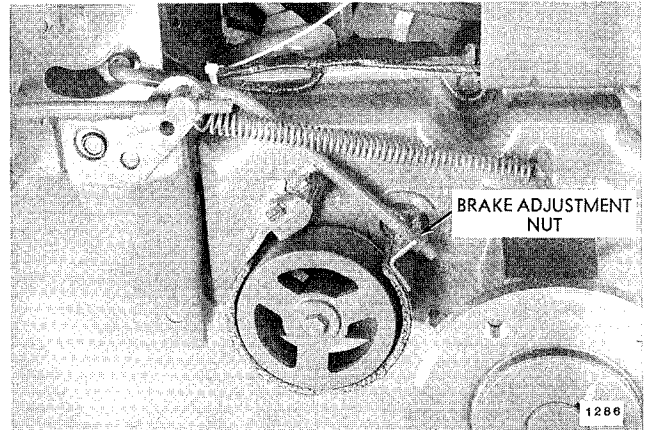

Brake Adjustment

PTO CLUTCH AND BRAKE ADJUSTMENT

PTO clutch and brake may require periodic adjustment due to normal wear of friction surfaces. If clutch slippage is apparent, turn trunnion farther onto clutch rod in one turn intervals until slippage is eliminated.

To adjust PTO brake:

1. Engage PTO clutch.
2. Loosen two bolts that hold brake pad bracket to support bracket.
3. Place a .012 in. (.3 mm) feeler gauge between brake pad and clutch pulley.
4. While holding brake pad against feeler gauge and pulley, tighten two brake bracket bolts.

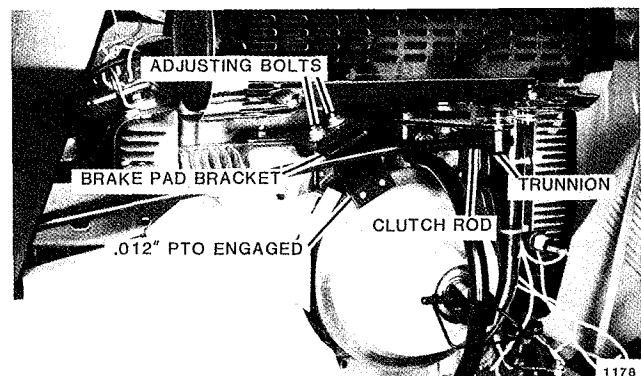

PTO Adjustments

EXHAUST SYSTEM

Make regular visible and audible inspections of exhaust system throughout life of tractor. Locate leaks in muffler and piping while engine is operating. Repair all leaks immediately after they are detected for personnel safety.

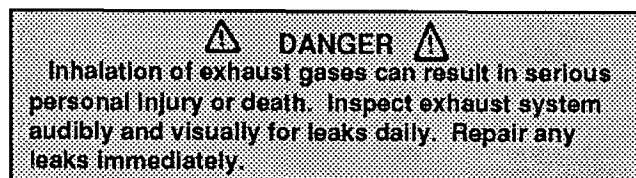

CLEANING AND STORAGE

Tractor should be washed regularly with a mild automotive detergent and water. After 30 days, painted surfaces may be waxed to protect original finish.

Minor paint scratches or abrasions can be removed with an automotive cleaning and polishing compound. Rubbing compound is not recommended under normal circumstances, as it is highly abrasive. Exposed bare metal surfaces should be given a light coating of oil or grease to prevent rust until permanent repairs can be made. Aerosol

cans of Toro Wheel Horse paint are available through your Authorized Toro Wheel Horse Dealer.

When tractor will not be used for an extended period of time, following steps will help insure minimum difficulty when unit is returned to service:

1. Perform required maintenance steps called for in "Maintenance Checklist".
2. Check tires for proper inflation.
3. Drain all fuel from fuel tank. Start tractor and let engine run out of gas. As gasoline grows old, it becomes less volatile and forms harmful gum and varnish deposits in carburetor and fuel pump. **DO NOT STORE GASOLINE FOR MORE THAN 2 MONTHS.**
4. Wash tractor and repaint all bare metal surfaces.
5. Charge battery. In temperatures lower than 40 degrees F (4 degrees C) a battery will maintain a charge for about 50 days. In temperatures above 40 degrees F (4 degrees C) water level should be checked and battery "trickle charged" every 30 days, (more often in higher temperatures). Battery must be fully charged to prevent freezing and internal damage in weather below 32 degrees F (0 degrees C).
6. Remove key from tractor.

TROUBLESHOOTING CHECKLIST

<u>SYMPTOM</u>	<u>POSSIBLE CAUSE</u>	<u>POSSIBLE REMEDY</u>
Engine will not turn over.	Dead battery. Open safety interlock switch. Starter. Solenoid. Ignition switch.	Charge or replace battery. Be sure PTO is disengaged and brake pedal is depressed. Consult authorized dealer. Consult authorized dealer. Consult authorized dealer.
Engine turns over but will not start.	Spark plug not firing. Ignition system. No fuel in tank. Fuel valve closed. Improper carburetor adjustment. Ignition switch.	Check spark plug condition and reset gap. Consult authorized dealer. Refuel tractor. Open fuel valve. Reset carburetor adjustment. Consult authorized dealer.
Engine hard to start.	Spark plug wire(s) grounded or loose. Ignition system. Spark plug(s) faulty or improperly gapped. Fuel line clogged. Faulty fuel pump. Carburetor dirty or improperly adjusted.	Check spark plug wires. Consult authorized dealer. Check spark plug condition and reset gap. Clean fuel line and if applicable, check fuel filter. Consult authorized dealer. Readjust carburetor. Consult dealer for authorized carburetor service.
Engine starts, but operates erratically.	Clogged fuel line. Water in fuel. Vent in fuel cap plugged. Ignition system. Improper carburetor adjustment.	Clean fuel line; check strainer in fuel tank. If applicable check in-line fuel filter. Drain old fuel and replace with fresh supply. Check vent. Consult authorized dealer. Readjust carburetor.

TROUBLESHOOTING CHECKLIST (Continued)

SYMPTOM	POSSIBLE CAUSE	POSSIBLE REMEDY
Engine knocks.	Fuel octane too low. Faulty Ignition System. Engine overheated.	Drain fuel and replace with higher octane supply. Consult authorized dealer. Shut off engine and allow to cool.
Engine occasionally "skips" at high speed.	Spark plug(s) fouled, faulty or gap too wide. Faulty Ignition System. Incorrect carburetor adjustment.	Check spark plug condition and gap. Consult authorized dealer. Readjust carburetor.
Engine overheating.	Air intake screen or fins clogged Oil level too high or too low. Fuel mixture too lean. Faulty Ignition System. Engine overloaded.	Clean intake screen and fins. Adjust oil level as necessary. Readjust carburetor. Consult authorized dealer. Reduce load on tractor.
Engine idles poorly.	Improper carburetor adjustment. Improper spark plug gap.	Readjust carburetor. Check condition and gap of spark plug(s).
Engine backfires.	Improper carburetor adjustment. Ignition system.	Readjust carburetor. Consult authorized dealer.
Engine runs fine, but tractor will not move.	Transmission not in gear. Faulty Transmission.	Select gear. Consult authorized dealer.
Engine stalls whenever PTO is engaged.	Excessive load on PTO. Faulty interlock system.	Check for jammed attachments. Lessen load on attachment. Seat must be occupied to close interlock system. Consult authorized dealer.

WIRING DIAGRAM - 310 MODEL

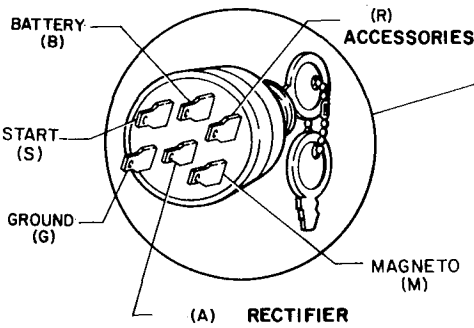
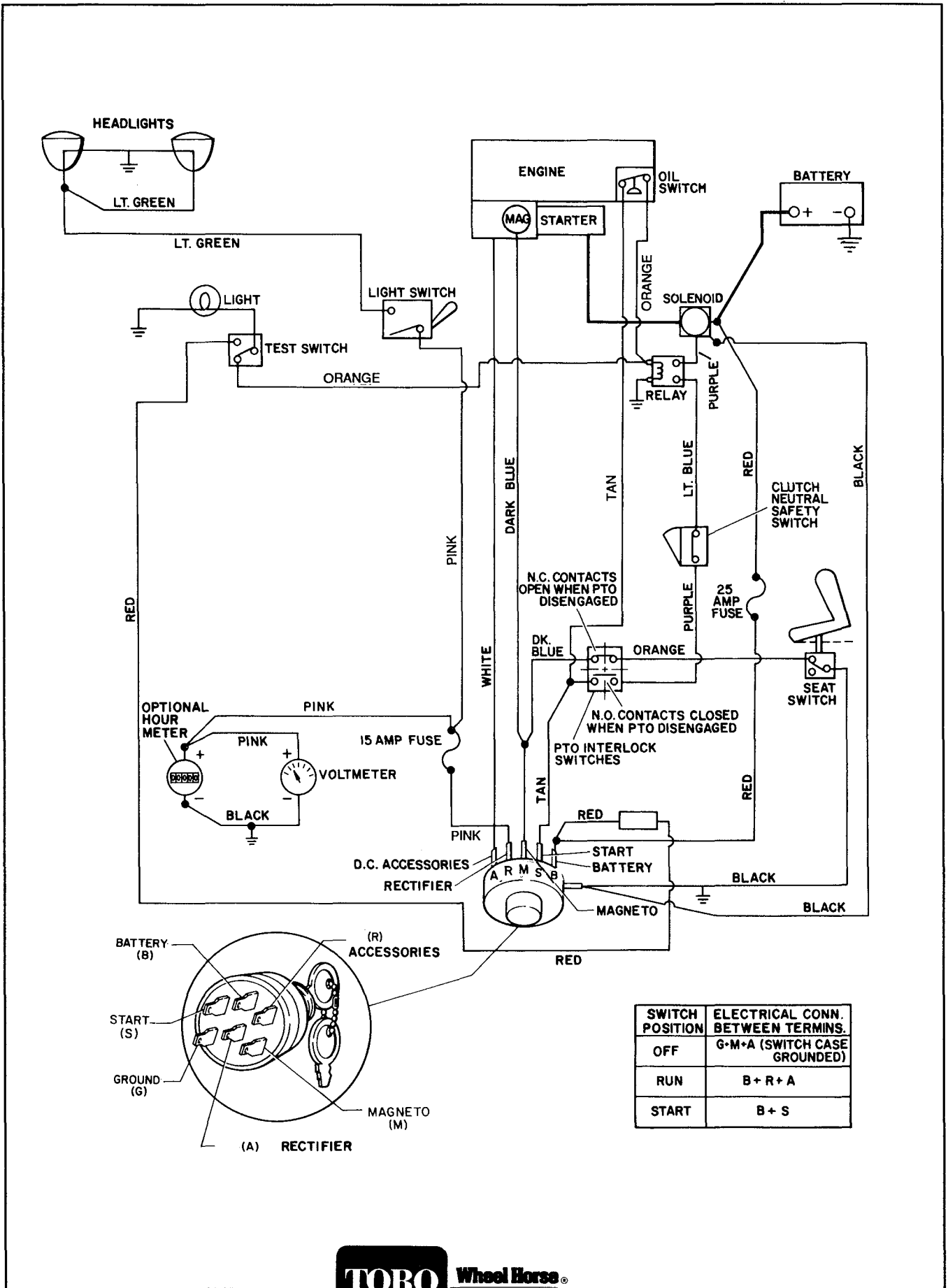

SWITCH POSITION	ELECTRICAL CONN. BETWEEN TERMIN.
OFF	G•M•A (SWITCH CASE GROUNDED)
RUN	B + R + A
START	B + S



WIRING DIAGRAM - 312

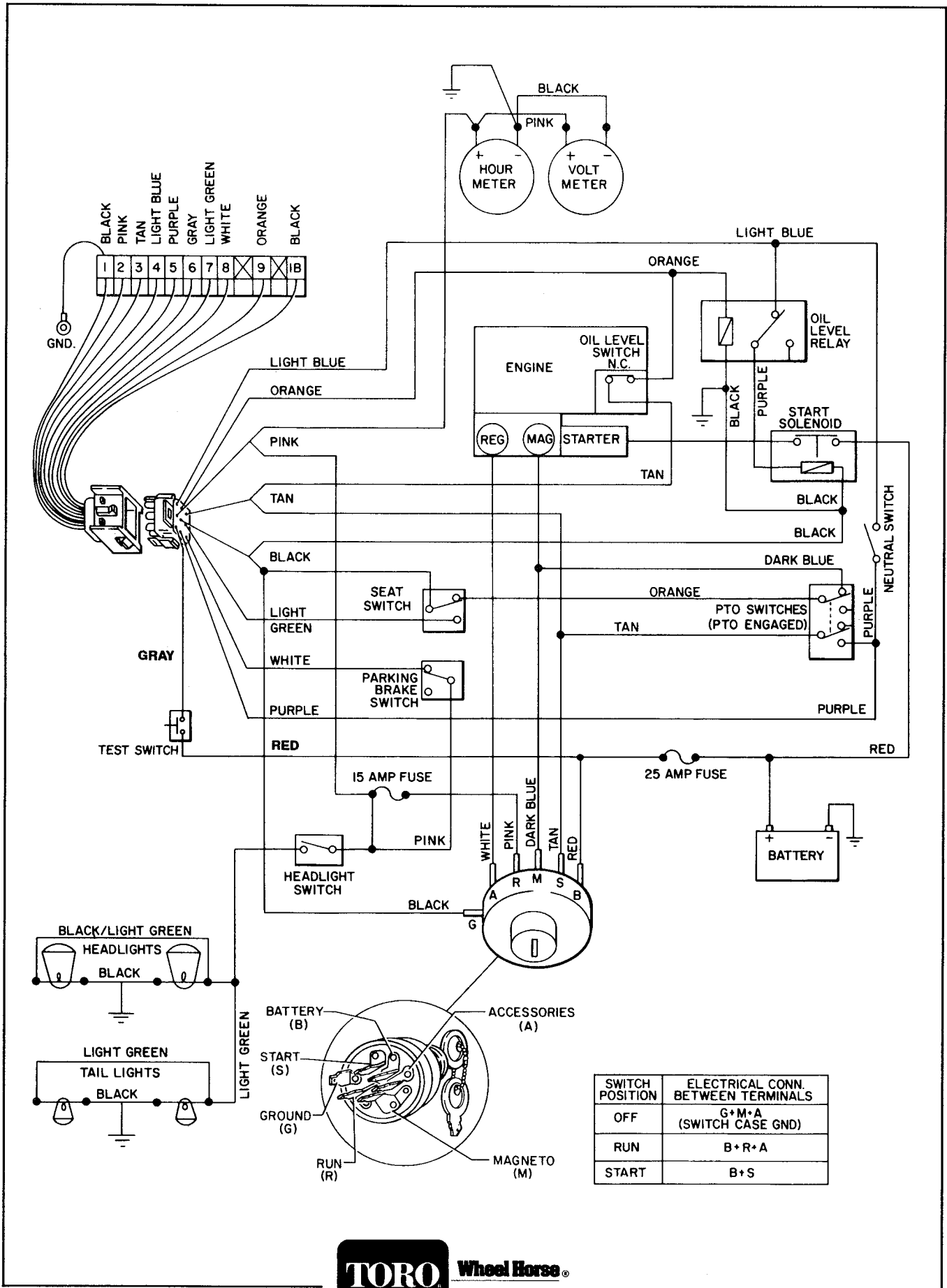

WIRING DIAGRAM - 416

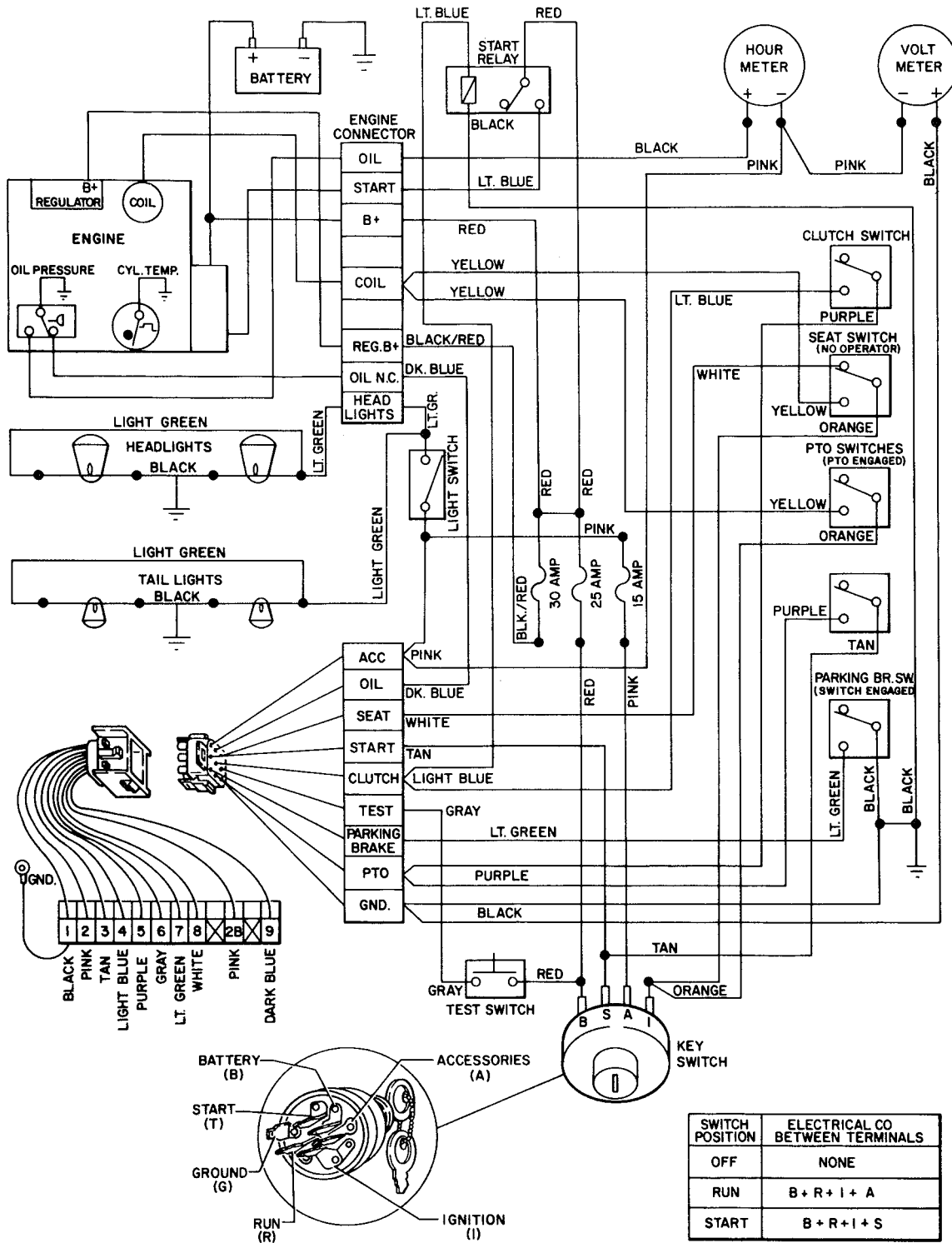

SWITCH POSITION	ELECTRICAL CO BETWEEN TERMINALS
OFF	NONE
RUN	B + R + I + A
START	B + R + I + S



A separate parts manual for your Toro Wheel Horse product can be obtained by completing the attached form below. You will receive an invoice with manual.

**PUBLICATIONS
TORO WHEEL HORSE
8111 Lyndale Ave. So.
Bloomington, Minnesota 55420**

PARTS MANUAL ORDER FORM

MAIL LABEL -- PLEASE PRINT CLEARLY

Enter number shown on your attachment:

TO:

Name _____

Address _____

City **State** **Zip**

MODEL	
SERIAL	
TORO Wheel Horse	
515 WEST IRELAND ROAD	
SOUTH BEND, INDIANA 46814 USA	

10° SLOPE CHART

Read all safety instructions on pages 3-6

ALIGN THIS EDGE WITH A VERTICAL SURFACE
(TREE, BUILDING, FENCEPOST, POLE ETC.)

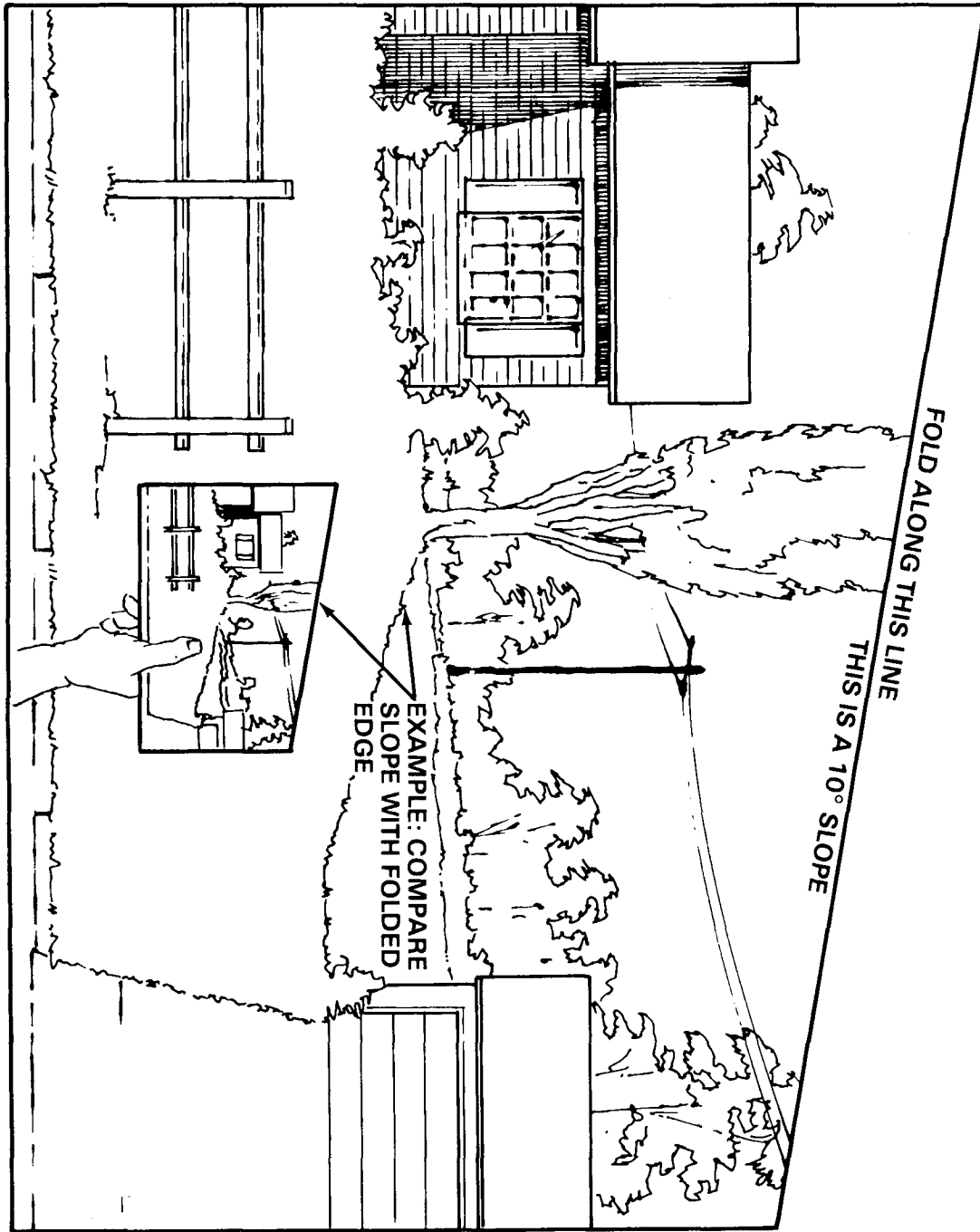

Your TORO Wheel Horse does more at home when it's equipped with TORO Wheel Horse attachments.

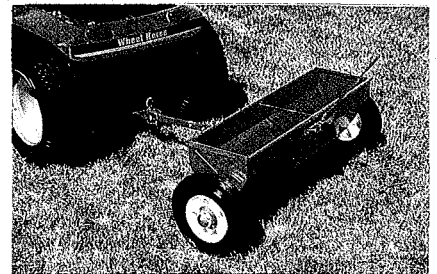
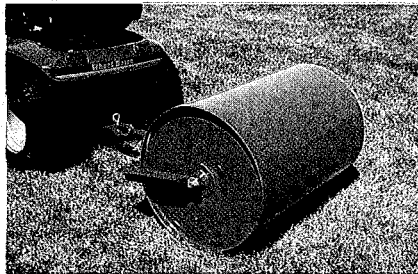
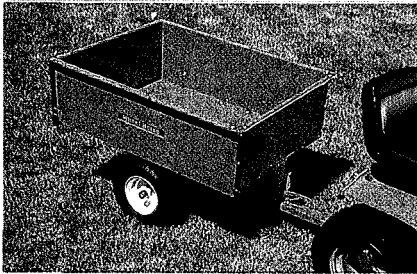
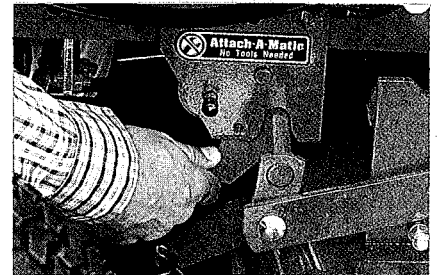
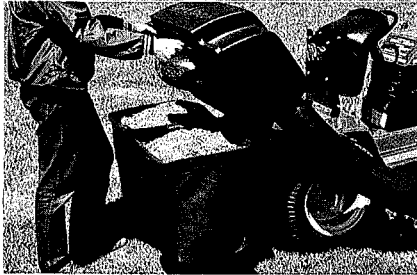

Product information and specifications are shown herein as of the time of printing. Toro Wheel Horse reserves the right to change product specifications, designs and standard equipment without notice and without incurring obligation.



Wheel Horse
Tractors & Riding Mowers