

<b>Material No:</b>	<b>111-7893</b>	<b>Rev:</b>	<b>A</b>	<b>Release/Change Authorization Number:</b>	<b>5095416</b>	<b>CONFIDENTIAL</b>
<b>Description:</b>	<b>MANUAL OPERATOR HARRIER 48</b> <b>[490_491:EN]</b>			<b>Issue Date :</b>	10/07/2014	
<b>HAYTER</b> <b>Technical</b> <b>Publications</b> <b>Assembly</b>	<b>Supersedes:</b>					
	<b>Created By :</b>				LH	
	<b>Scale :</b>				None	
	THIS UNPUBLISHED DOCUMENT CONTAINS HAYTER CONFIDENTIAL AND PROPRIETARY INFORMATION. IT MAY NOT BE WHOLLY OR PARTIALLY COPIED, DISCLOSED TO OTHERS, OR USED FOR ANY PURPOSE WITHOUT WRITTEN PERMISSION FROM HAYTER. IF PUBLICATION OCCURS, THE FOLLOWING NOTICE APPLIES: "HAYTER ALL RIGHTS RESERVED".					
<b>Reason for Revision:</b>	RELEASE TO PRODUCTION					

**Comments**

COVER PAGE FOR MANUAL OPERATOR HARRIER 48 [490\_491:EN]



**HAYTER**  
MAKERS OF THE FINEST MOWERS

*Harrier 48*  
*Codes 490H & 491H*

*OWNER'S HANDBOOK*



**Original Version (EN)**  
**Issued: 09/10/2014**

**From Serial Number: 31500001 Onwards**  
**Part number: 111-7893 Rev A**

# CONTENTS

<b>Introduction</b>	<b>3</b>	Height of Cut	10
<b>Safety Compliance</b>	<b>3</b>	Grassbag	10
<b>Main Features</b>	<b>4</b>	Collection Without Grassbag	11
<b>Specifications</b>	<b>4</b>	Heavy Growth	11
<b>Safety Symbols</b>	<b>5</b>	Friction Disc	11
<b>Safety Precautions</b>	<b>6 - 7</b>	Non Grassed Areas	11
Safety Alert Symbol	6	<b>Maintenance Schedule</b>	<b>12</b>
Training	6	<b>Mower Maintenance</b>	<b>13 - 17</b>
Preparation	6	Engine Detail	13
Operation	6 - 7	Carburettor Adjustments	13
Maintenance & Storage	7	Oil Service	13
<b>Assembling the Mower Before First Use</b>	<b>8</b>	Air Cleaner Service	13
Delivery Checklist	8	Spark Plug Service	13
Handlebar	8	Keeping Engine Clean	14
Grassbag Assembly	8	Grassbag	14
Grassbag Attachment	8	Deck Housing	14
Prevent Engine Damage	8	Securing Nuts & Bolts	14
Oil Type	8	Clutch Cable Adjustment	14
Check Oil Level	8	Lubrication	14
<b>Operating the Mower</b>	<b>9 - 11</b>	Cutterblade Removal	15
Fuel Type	9	Cutterblade Assembly	15
Controls	9	Cutterblade Sharpening	15
Before Mowing	9	Storage	16
Starting (490 only)	9	Battery Charging (491 only)	16
Electric Start (491 only)	9	Battery Disposal (491 only)	17
Forward Travel	10	<b>Lawn Care Calendar</b>	<b>18</b>
Reverse Travel	10	<b>Trouble Shooting</b>	<b>19</b>
Turning	10	<b>Warranty</b>	<b>20</b>
Stopping	10	<b>EU Privacy Statement / Notes</b>	<b>23</b>
Slopes	10	<b>Service Records &amp; Customer Information</b>	<b>24</b>

# INTRODUCTION

Thank you for purchasing a Hayter mower. The following pages are designed to help you gain safe and efficient service from your machine.

**IMPORTANT:** This 'Owners Handbook' should be regarded as part of the mower as it gives essential information regarding mower safety, operation, maintenance and specifications. Read and understand this handbook prior to operating your mower for the first time. Make sure you are familiar with all the controls and points of regular maintenance. If you have any doubts, consult your local Hayter authorised dealer who will be pleased to give you assistance.

**IMPORTANT:** This mower is designed solely for use in a domestic grass cutting environment. Use in any other way is considered as contrary to the intended use. Compliance with and strict adherence to the conditions of operation, service and repair as specified in this handbook also constitute essential elements of the intended use.

This mower should be operated, serviced and repaired only by persons who are familiar with its particular characteristics and who are acquainted with the relevant safety procedures.

The safety precautions listed in this handbook and all other generally recognised regulations on safety must be observed at all times.

Use of non standard parts or any arbitrary modifications carried out on this machine may relieve Hayter Limited of liability for any resulting damage or injury.

Hayter mowers are robustly constructed and designed for efficient economical performance under normal mowing conditions. Correct operation and maintenance will ensure a long and satisfactory service life. Prior to despatch from our factory every effort is made to ensure that your mower is delivered in perfect condition.

Throughout this handbook all references to **left** and **right** are as viewed from behind the handlebar, in the direction of forward travel.

This handbook is based on information available at the time of publication.

HAYTER LIMITED reserve the right to amend product specifications without prior notification.

Please be advised that the illustrations in this Handbook are generic and not specific to your product.

# SAFETY COMPLIANCE

To ensure low noise and vibration levels, carry out the following procedures correctly:

- To prevent overloading the engine, use the correct height of cut and ground speed (where applicable).
- Follow the recommended maintenance instructions.
- Do not use your mower for prolonged periods of time.
- Always wear hearing protection.

## VIBRATION INFORMATION

Hand / Arm Vibration Level at the Operator Position measured in accordance with European Standard EN ISO 5395:2013.

	<b>490</b>	<b>491</b>
Measured Vibration Level ahw	3.5 ms <sup>-2</sup>	3.5 ms <sup>-2</sup>
Uncertainty of measurement K	1.5 ms <sup>-2</sup>	1.5 ms <sup>-2</sup>

## SOUND PRESSURE INFORMATION

Sound Pressure Level at the Operator Position measured in accordance with European Standard EN ISO 5395:2013.

	<b>490</b>	<b>491</b>
Measured Sound Pressure Level LpA	85 dB (A)	85 dB (A)
Uncertainty of measurement K	2 dB (A)	2 dB (A)

## SOUND POWER INFORMATION

Sound Power Level measured in accordance with European Standard EN ISO 5395:2013.

	<b>490</b>	<b>491</b>
Measured Sound Power Level LwA	95 dB (A)	95 dB (A)
Uncertainty of measurement K	1 dB (A)	1 dB (A)

For a full range of products and to locate your nearest authorised sales stockist, service or parts dealer please visit our website at [www.hayter.co.uk](http://www.hayter.co.uk)

# MAIN FEATURES

# SPECIFICATIONS

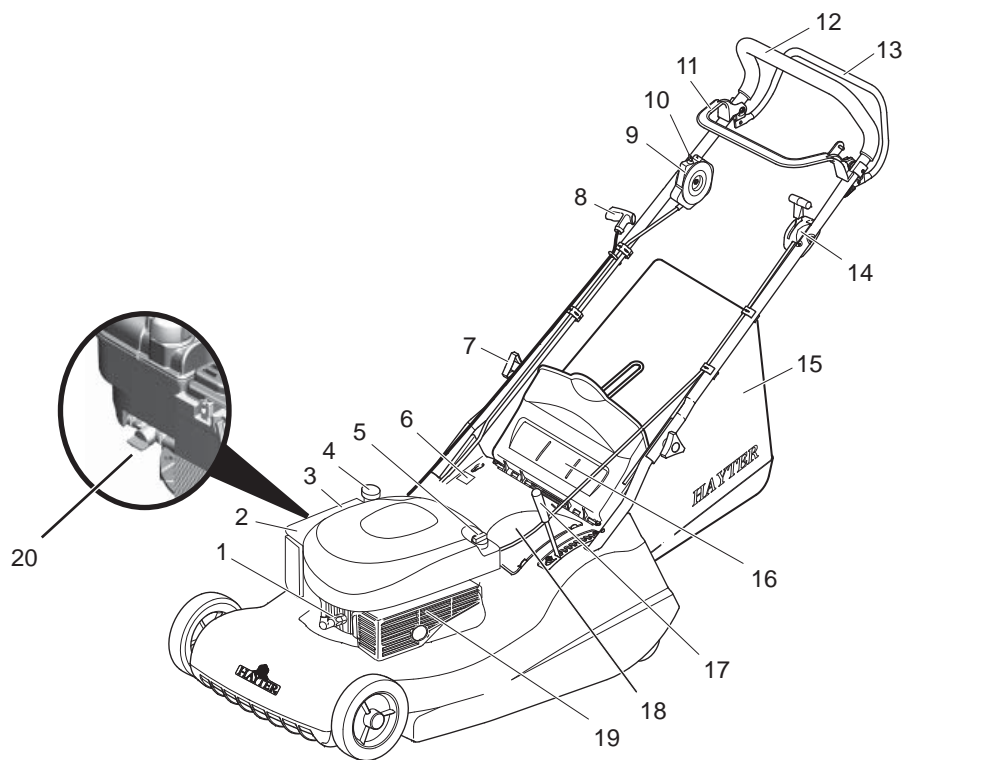

- |                                |  |
|--------------------------------|--|
| 1. Spark plug lead             | 11. Engine stop lever                              |
| 2. Engine cover                | 12. Handlebar                                      |
| 3. Air cleaner                 | 13. Ground drive clutch lever                      |
| 4. Fuel filler cap             | 14. Variable transmission speed control (see note) |
| 5. Oil filler cap and dipstick | 15. Grassbag assembly                              |
| 6. Serial number label         | 16. Rear deflector                                 |
| 7. Handlebar securing knob     | 17. Height of cut adjuster                         |
| 8. Engine start-grip           | 18. Battery (491 only)                             |
| 9. Electric start (491 only)   | 19. Exhaust guard                                  |
| 10. Key (491 only)             | 20. Fuel shutoff valve                             |

Note: Item 14 should only be operated whilst the engine is running or the cable will be damaged.

<b>Code</b>	490	491
<b>Weight</b>	44.6 kg	48.5 kg
<b>Length</b>	1510 mm	1510 mm
<b>Width</b>	507 mm	507 mm
<b>Height</b>	1080 mm	1080 mm
<b>Width of Cut</b>	48 cm	48 cm
<b>Height of Cut</b>	13 - 60 mm	13 - 60 mm
<b>Cutterblade Speed</b>	2750 rpm	2750 rpm
<b>Engine</b>	Briggs & Stratton	Briggs & Stratton
<b>Engine Type</b>	Series 650	Series 650
<b>Engine Power Rating (Net)</b>	2.4 kw	2.4 kw
<b>Fuel Type*</b>	Unleaded petrol	Unleaded petrol
<b>Fuel Capacity</b>	1 litre	1 litre
<b>Oil Type</b>	SAE 30 engine oil	SAE 30 engine oil
<b>Oil Sump Capacity</b>	0.6 litres	0.6 litres

\* A minimum of 87 octane / 87 AKI (91 RON).

\* Petrol with up to 10% ethanol is acceptable.

\* Do not use unapproved fuels, such as E15 and E85

# SAFETY SYMBOLS

**Description:** Safety alert be aware to the possibility of injury

**Part Number:** 111-0083



**Description:** Stop the engine and remove the spark plug before working on the mower

**Part Number:** 111-0083



**Description:** Carefully read the Owners Handbook before using the machine

**Part Number:** 111-0083



**Description:** Danger of being hit by thrown objects

**Part Number:** 111-0083



**Description:** Keep bystanders at a safe distance from the mower

**Part Number:** 111-0083



**Description:** Danger of severing toes or fingers in cutting mechanism

**Part Number:** 111-0083



**Description:** Engine stop

**Part Number:** Moulded onto engine stop lever



**Description:** Engine start (Code 491H only)

**Part Number:** Printed on switch housing



**Description:** Variable transmission speed control

**Part Number:** Printed on control

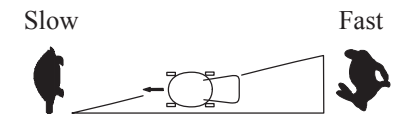

Variable transmission speed control

**Description:** Height of Cut

**Part Number:** 320006



# SAFETY PRECAUTIONS

## Safety Alert Symbol

This safety alert symbol indicates important safety messages. When you see this symbol be alert to the possibility of injury. Carefully read the following and inform others.

Your mower is perfectly safe if used correctly. Failure to observe the following precautions may result in serious injury.

## Training

Before using the mower read the owners handbook carefully. Pay particular attention to the safety precautions. Ensure that you are familiar with the controls and the proper use of the equipment. Learn how to stop the mower quickly in an emergency.

Never allow children or people unfamiliar with these instructions to use the mower. Local regulations can restrict the age of the operator.

Never mow while people, especially children, or pets are nearby.

Keep in mind that the user is responsible for accidents or hazards occurring to other people or their property.

All operators and mechanics should be trained. The owner is responsible for training users. Do not operate the machine under the influence of alcohol or drugs.

## Preparation

Whilst mowing, always wear substantial slip resistant footwear and long trousers. Do not operate the equipment when barefoot or wearing sandals.

Thoroughly inspect the area where the mower is to be used and remove all objects which may be thrown by the machine.

**WARNING:** Petrol is highly flammable:

- Store fuel in containers specifically designed for this purpose
- Refuel outdoors only and do not smoke while refuelling;
- Add fuel before starting the engine. Never remove the cap from the fuel tank or add petrol while the engine is running or when the engine is hot;
- If petrol is spilt, do not attempt to start the engine but move the machine away from the area of spillage and avoid creating any source of ignition until the petrol vapours have dissipated;
- Replace all fuel tank and container caps securely;
- Always use fresh fuel which contains 10% or less ethanol. Stale fuel can block the carburettor and cause leakage. High levels of ethanol can cause engine damage.

Replace faulty exhaust.

Replace faulty silencers.

A damaged cutterblade or loose fixing bolt are major hazards. Before use, always visually inspect the cutting mechanism to ensure that it is in good condition. A damaged cutterblade must be replaced immediately with a genuine Hayter replacement part.

Do not tamper with or disable the mower safety systems, sealed adjusters or other features.

Before use, ensure that all starting interlocks and operator presence controls are properly functioning. Refer to Operating the Mower.

Do not alter or tamper with the engine speed control.

## Operation

Do not operate the engine in a confined space where exhaust fumes (carbon monoxide) can collect.

Always pull the starter cord slowly until resistance is felt. Then pull the cord rapidly to avoid kickback and prevent hand or arm injury.

Mow only in daylight or good artificial light.

Avoid using the machine on wet grass, where feasible. Always be sure of your footing on slopes.

Walk, never run.

Do not operate the mower near drop-offs, ditches or embankments.

Do not mow excessively steep slopes of more than 20° and mow across the face of slopes, never up and down.

Exercise extreme caution when changing direction.

Use extreme caution when reversing or pulling the mower towards you.

Always replace worn or faulty parts with genuine Hayter parts.

This machine contains spring loaded assemblies which could cause a hazard when disassembled and re-assembled, this maintenance should only be carried out by a Hayter authorised dealer.

If the machine has to be tilted for transportation when crossing surfaces other than grass, and when transporting the machine to and from the area to be mowed, stop the blades by releasing the engine stop lever and ensure that the blades have stopped before tilting the mower.

# SAFETY PRECAUTIONS

## Operation *cont*

Never operate the machine with defective guards, or without safety devices, for example deflectors and/or grass bag in place.

Do not change the engine governor settings or overspeed the engine.

Start the engine carefully, with feet well away from the cutterblade and always disengage the rear roller drive clutch before starting the engine.

Do not tilt the mower when starting the engine.

Do not start the engine if standing in front of the discharge chute.

Do not put hands or feet near or under rotating parts.

Never pick up, carry the mower or lift the rear deflector whilst the engine is running.

Never touch the exhaust / exhaust guard or cooling fins when the engine is hot.

**THE CUTTERBLADE CAN CONTINUE TO ROTATE AFTER THE MACHINE IS SWITCHED OFF.**

### Stop the engine and disconnect the spark plug lead:

- Before clearing blockages or unclogging the discharge chute;
- Before cleaning / checking or working on the machine;
- After striking a foreign object. Inspect the machine for damage and ensure necessary repairs are made before re-starting and operating;
- If the machine starts to vibrate abnormally (check immediately).

### Stop the engine:

- Whenever you leave the mower;
- Before refuelling.

Take care when loading or unloading the mower into a trailer or truck. Tie the mower down securely using straps, chains, cable or ropes. Both the front and rear straps should be directed down and outward from the mower.

Lightning can cause severe injury or death. If lightning is seen or thunder is heard in the area, do not operate the mower; seek shelter.

## Maintenance & Storage

Keep all nuts, bolts and screws tight to ensure that the equipment is in safe operating condition.

Frequently check fuel lines and fittings for cracks or leaks and replace if necessary.

Inspect the exhaust periodically and replace if worn or leaking.

Check the rear deflector and grassbag frequently for wear or deterioration.

Replace worn or damaged parts for safety.

Wear strong work gloves when removing and reassembling the cutterblade.

Never store the mower with petrol in the tank within an enclosed area where fumes may reach an open flame or spark.

Allow the engine to cool before storing in any enclosure.

To reduce the fire hazard, keep the engine and the surrounding deck area free of grass, leaves or excessive grease.

If the fuel tank has to be drained, this should be done outdoors

and when the engine is cool.

When transporting your mower, ensure that the fuel shutoff valve is in the 'OFF' position.

*(Refer fig.1)*

# ASSEMBLING THE MOWER BEFORE FIRST USE

## Delivery Checklist

Remove the mower from the packaging and check that the following items have been supplied correctly. If any items are missing, contact your local Hayter dealer.

1. Engine Handbook
2. Grassbag Assembly
3. Parts List
4. Declaration of Conformity
5. Charger (491)
6. Ignition Key (491)

To prevent accidents cut off the long ribbon attached to the grassbag and discard.  
*(Refer fig.2)*

**(491 Only) Note: Prior to first use please fully charge the battery for 14 hours. (Refer to Battery Charging).**

## Handlebar

Unscrew the handlebar securing knobs sufficiently to allow the handlebar to pivot. Hold the engine stop lever in towards the handlebar and unfold the handlebar to the operating position, then release.

Tighten both handlebar knobs to secure in position.  
*(Refer fig.3)*

**Take care to ensure that the control cables do not become snagged at the pivot points.**

## Grassbag Assembly

Before first use assemble the grassbag and frame. Slide the frame (1) into the grassbag (2), ensuring that the handle is above the grassbag as shown. Attach plastic clips (A), (B), (C) and (D) to the grassbag frame.  
*(Refer fig.4)*

## Grassbag Attachment

Once the grassbag (3) is assembled, raise the rear deflector (1), pass the grassbag through the handlebar and hook into position (2). Lower the rear deflector to rest on the grassbag.  
*(Refer fig.5)*

## Prevent Engine Damage

**To prevent engine damage the engine is shipped without oil or petrol. The engine must be filled with the correct grade of oil and petrol before starting the engine. Please refer to your engine manual for more information.**

## Oil Type

Always use high quality detergent oil classified SAE 30 oil. Never use additives with recommended oil. To prolong the life of your engine it is important that the oil is changed after the first 5 hours of use. Please refer to the Maintenance Schedule in this Handbook.  
*(Refer fig.6)*

## Check Oil Level

Place engine level.

Clean the oil fill area of any debris.

- Remove the dipstick and wipe with a clean cloth.
- Insert and tighten the dipstick.
- Remove the dipstick and check the oil level. It should be at the top of the full indicator on the dipstick.
- If low, add oil slowly into the engine oil fill. Do not overfill. After adding oil, wait one minute and then recheck the oil level.
- Replace and fully tighten dipstick.  
*(Refer fig.7)*

Fig. 1



Fig. 2

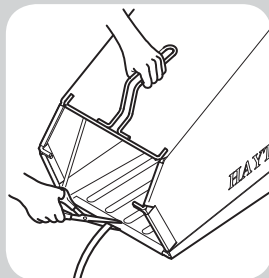

Fig. 3

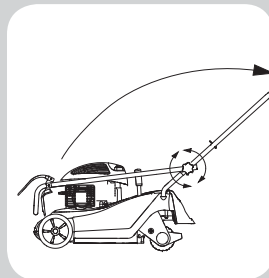

Fig. 4

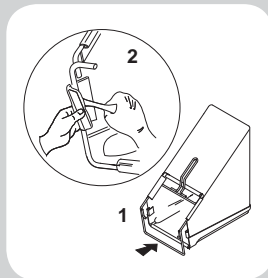

Fig. 5

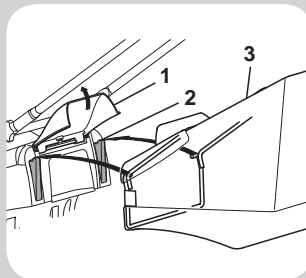
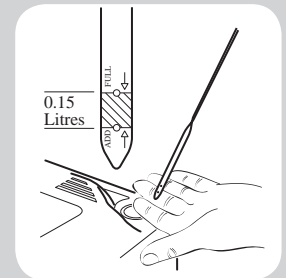

Fig. 6



Fig. 7



# OPERATING THE MOWER

## Fuel Type

Purchase fuel in quantities that can be used in 30 days.

Fuel must meet these requirements:

- Clean, fresh, unleaded petrol.
- A minimum of 87 octane / 87 AKI (91 RON).  
Petrol with up to 10% ethanol is acceptable.

**CAUTION: Do not use unapproved fuels, such as E15 and E85. Do not mix oil in fuel or modify the engine to run on alternate fuels. Use of unapproved fuels will damage the engine components and void the engine warranty.**

To protect the fuel system from gum formation, mix a fuel stabiliser into the fuel. All fuel is not the same. If starting or performance problems occur, change fuel providers or change brands. The engine is certified to operate on petrol.

**Fill to base of neck to allow for fuel expansion. Do not overfill the fuel tank.**

*(Refer fig.8)*

## Controls

Operate all control levers several times and ensure that the cables move freely. Check that the engine stop and ground drive clutch levers return freely to their rest position when released.

*(Refer fig.9)*

**IMPORTANT: To avoid damage to the cable the variable transmission speed control should only be operated whilst the engine is running.**

## Before Mowing

To prevent accidents, thoroughly inspect the area and remove all objects which when contacted by the mower cutterblade could become dangerous projectiles. Inspect the area for hidden obstructions which when contacted by the cutterblade could risk health and safety or result in damage to the mower. Remember the location of these obstructions and ensure that you mow around them.

*(Refer fig.10)*

## Starting (490 only)

Ensure that the fuel shutoff valve is in the 'ON' position before attempting to start your mower for first use.

*(Refer fig.11)*

Stand behind the mower and hold the handlebar together with the engine stop lever with your left hand. With your right hand hold the engine start - grip and pull slowly until resistance is felt, release, then pull rapidly to crank the engine. Carefully return the start grip to the storage position when the engine starts.

*(Refer fig.12)*

If the engine does not start after 3 attempts - Refer to Trouble Shooting.

The engine stop lever must be held firmly against the handlebar to start and keep the engine running. If the engine stop lever is released the engine will stop.

**To prevent damage never pull the engine start grip when the engine is running.**

## Electric Start (491 only)

Stand behind the mower and hold the handlebar together with the engine stop lever. Turn the ignition key in a clockwise direction and hold in position to crank the engine. When the engine starts release the key.

*(Refer fig.13)*

**Note:** Cranking the engine for more than 15 seconds in any one minute can damage the starter motor.

**If necessary the engine can be started manually without using the ignition switch. To prevent engine damage do not operate the ignition key when the engine is running.**

Fig. 8

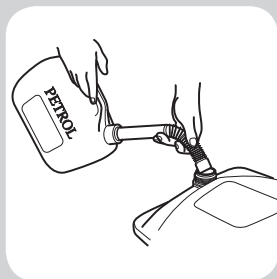

Fig. 9

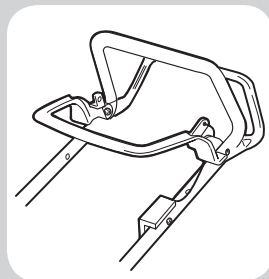

Fig. 10

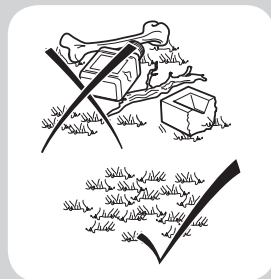

Fig. 11



Fig. 12

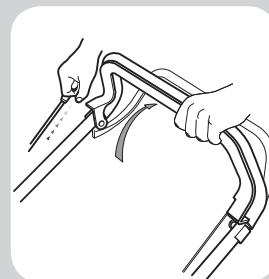
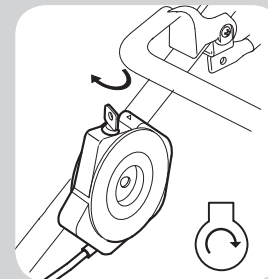

Fig. 13



# OPERATING THE MOWER

## Forward Travel

Hold the handlebar and operate the ground drive clutch lever to power the mower in a forward direction.

(Refer fig.14)

When the ground drive clutch lever is disengaged the mower may be pushed. This feature is useful when mowing in confined areas.

Ground speed may be adjusted by operating the variable transmission speed control. Push forward to slow down and pull back to speed up.

Only operate the lever with the engine running to prevent damage.

If the engine stop lever is released the engine will stop.

## Reverse Travel

Release the ground drive clutch lever.

Hold and pull against the handlebar with both hands to reverse the mower.

(Refer fig.15)

## Turning

To make a wide turn steer the mower with the handlebar in the

direction required.

To make a tight turn release the ground drive clutch lever, apply downward pressure on the handlebar to raise the front wheels just above ground level and steer in the required direction.

**To prevent accidents do not raise the front of the mower excessively when making a turn. Never raise the rear of the mower when the engine is running.**

## Stopping

Release the engine stop lever and then the ground drive clutch lever.

**Emergency stop: As above. If the engine fails to stop disconnect the spark plug lead.**

**If the engine fails to stop, disconnect the spark plug lead.**

(Refer fig.16)

## Slopes

To prevent engine damage do not use the mower on slopes greater than 20 degrees.

(Refer fig.17)

## Height Of Cut

**To adjust the height of cut:**

Hold the lever and pull sideways to disengage it from the locking notch, then pull backwards to raise the height of cut or push forwards to lower the height of cut. Finally release the lever at the required position and ensure it locks firmly into one of the setting notches.

Always select a height of cut to suit operating conditions. Aim to prevent engine overloading and blockages by avoiding low cuts in long grass conditions. Be prepared to make two cuts when the grass is long.

(Refer fig.18)

## Grassbag

Raise the rear deflector, lift the grassbag and lower the rear deflector to rest against the rear of the mower.

To empty the grassbag, pour out the grass clippings and shake the grassbag vigorously to clean the airways. Good grass collection depends on good air flow through the grassbag. When collecting grass clippings it is important that the grassbag is emptied regularly to prevent blockages and engine overloading.

(Refer fig.19)

Fig. 14

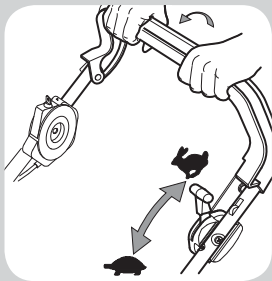

Fig. 15

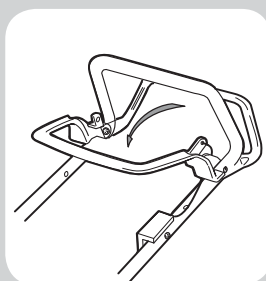

Fig. 16

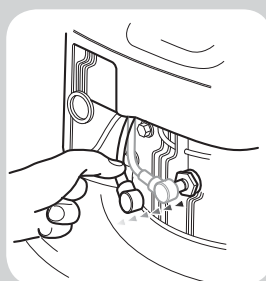

Fig. 17

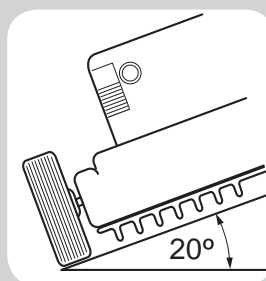

Fig. 18

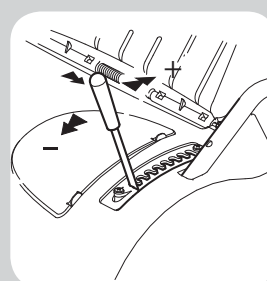
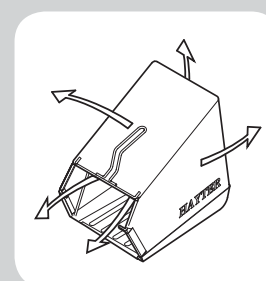

Fig. 19



# OPERATING THE MOWER

## Collection Without Grassbag

Remove the grassbag and operate the mower with the rear deflector in the closed position.

(Refer fig.20)

## Heavy Growth

Areas of heavy growth should be mown without collecting the clippings. If collection is required, first mow the area without the grassbag at the maximum height of cut setting.

Allow the grass clippings to dry out and then mow the area at the maximum height of cut setting with the grassbag fitted.

Reduce the height of cut and mow the area again as necessary until the required finish is obtained.

To prevent damage to your lawn do not remove more than one third of grass height in one cut.

(Refer fig.21)

## Friction Disc

The cutterblade is driven by the engine via a friction disc to help prevent damage occurring to the engine crankshaft and cutting mechanism when a hidden obstruction or overload is encountered.

(Refer fig.22)

Always stop the engine when a hidden obstruction or excessive vibration is encountered. Disconnect the spark plug lead and examine the cutting mechanism. ALWAYS replace a damaged cutterblade. Refer to Maintenance.

## Non Grassed Areas

When moving the mower across non-grassed areas, stop the engine and set the mower to the maximum height of cut to protect the cutting mechanism.

(Refer fig.23)

Fig. 20

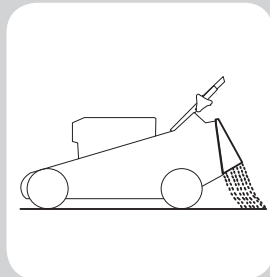

Fig. 21

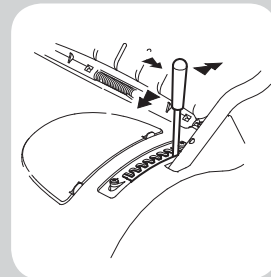

Fig. 22

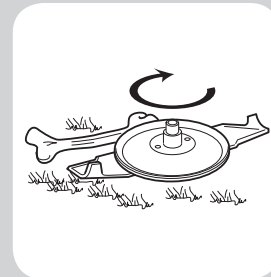
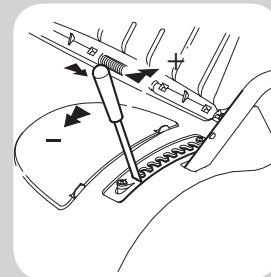

Fig. 23



# ***MAINTENANCE SCHEDULE***

## ***Maintenance Schedule***

Follow the hourly or calendar intervals, whichever occurs first. More frequent service will be required if working for prolonged periods under dusty, dry conditions, when airborne debris is present or after extensive operation cutting tall, dry grass.

### ***First 5 Hours***

- After the very first five hours change the engine oil.
- Adjust the autodrive clutch cable.

### ***Daily***

- Check the oil level.
- Remove grass debris from around the engine, exhaust / exhaust guard, air ways in the top cowl and the underside of the deck housing.
- Check the condition of guards and safety devices.
- Check condition of cutterblade.
- Check condition of grassbag and ensure airways are clear (replace if damaged).

### ***25 Hours Or Every Season***

- Change the engine oil if continuously operating under heavy load or high ambient temperature.
- Service the air cleaner.
- Lubricate wheels, pivot points and linkages.
- Grease the inner control cables at point of entry and exit from their outer casing.
- Check the clutch cable adjustment.

- Sharpen the cutterblade.

### ***50 Hours Or Every Season***

- Change the engine oil.

### ***100 Hours Or Every Season***

- Clean the engine cooling system. Clean more often under dusty conditions or when airborne debris is present or after prolonged operation whilst cutting tall, dry grass.
- Replace the spark plug.

# MOWER MAINTENANCE

## Engine Detail

(Refer to fig.24)

## Carburettor Adjustments

These adjustments should only be made by an authorised Briggs & Stratton dealer. Under no circumstances should the engine be adjusted to run at a speed in excess of that shown on the Declaration of Conformity.

## Oil Service

Check the oil level daily before starting the engine and ensure that the correct oil level is maintained. Refer to Assembling the Mower Before First Use for oil checking and filling instructions.

Change the engine oil after the first 5 hours of operation and thereafter according to the Maintenance Schedule.

Drain the fuel by running the engine until the fuel tank is empty.

Remove the spark plug lead.

Allow the engine to cool.

Drain the oil whilst the engine is warm (not hot).

Tip the mower over on to its left hand side ensuring that the air cleaner is kept uppermost to prevent engine damage.

Remove the oil filler dipstick and drain the oil into a suitable container.

(Refer to fig.25)

- Refill with new oil of the recommended SAE viscosity grade. Refer to Assembling the Mower Before First Use.

## Air Cleaner Service

To service the air cleaner, loosen screw (1) and remove cover (2).

(Refer to fig.26)

Remove cartridge (3) and clean by tapping gently on a flat surface. If very dirty, replace.

- Do not use petroleum solvents.
- Do not use pressurised air.
- Do not oil the cartridge.

After servicing, install the cartridge into the cover. Insert the tabs on the bottom of the cover into the slots in the bottom of the base (4). Tilt the cover upwards and securely tighten the screw

to the base.

## Spark Plug Service

Use only Briggs & Stratton (Part number 19368) spark tester (1) to check for a spark as shown in the diagram.

(Refer to fig.27)

Replace the spark plug every 100 hours or every season, whichever occurs first. A spark plug wrench is available from any authorised Briggs & Stratton service dealer.

Check the spark plug gap with a feeler gauge and set at 0.50 mm.

(Refer to fig.28)

Fig. 24

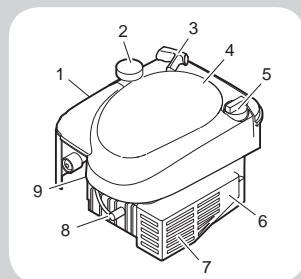

1. Air Cleaner
2. Fuel Cap
3. Start Grip
4. Cover
5. Oil fill / Dipstick
6. Exhaust Guard
7. Exhaust
8. Spark Plug / Lead
9. Carburettor

Fig. 25

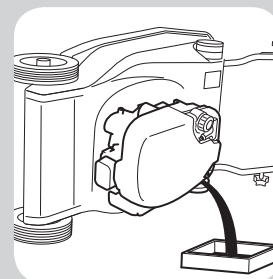

Fig. 26

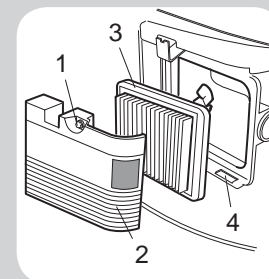

Fig. 27

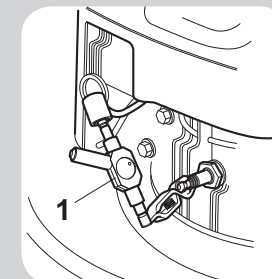
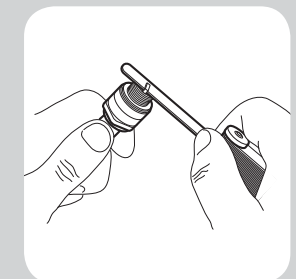

Fig. 28



# MOWER MAINTENANCE

## Keeping Engine Clean

Remove all grass and debris from the engine including the exhaust / exhaust guard, the air ways in the top cowl and the surrounding deck areas on a daily basis after use.

Never spray the engine with water during cleaning. Water can contaminate the fuel. Always clean with a brush or compressed air.

(Refer to fig.29)

Grass and debris may clog the engines air cooling system especially after prolonged operation whilst cutting tall, dry grass. The internal cooling fins and surfaces may require cleaning to prevent overheating and engine damage. We recommend that this service be carried out by an authorised Hayter Service Dealer.

## Grassbag

Remove grass debris from the grassbag immediately after use and check its condition for signs of damage.

**To prevent accidents replace a damaged grassbag immediately.**

(Refer fig.30)

## Deck Housing

Remove grass debris from the top and underside of the deck housing immediately after use.

(Refer fig.31)

Fertilisers and top dressings are particularly corrosive. Thoroughly clean the mower deck immediately after use on treated grass and store well away from corrosive materials.

## Securing Nuts & Bolts

Regularly check that all securing nuts and bolts are tight. Replace missing or damaged items immediately.

## Clutch Cable Adjustment

At any time the operator feels that the machine is loosing drive, check the following.

- Stop the engine.
- Pull the machine backwards at the same time progressively engage the clutch lever until the rear rollers lock, at this point the clutch lever should be 60 mm from the handlebar.
- If the distance between the clutch lever and handlebar is less than 60 mm regulate the engagement position with the black plastic cable adjuster to regain the 60 mm distance.

(Refer figs.32 & 33)

- Note this is a temporary adjustment and at the nearest opportunity a service should be carried out to ensure the spring on the clutch cable attached to the gearbox clutch is set correctly. This adjustment should be done using the metal adjuster at the control with the plastic adjuster reset fully wound in. When the spring is set tighten the inner lock nut to secure in position.

(Refer fig. 34 & 35)

## Lubrication

Lubricate the wheels, pivot points and linkages with engine oil every 25 operating hours.

Apply a good quality medium grease to the inner control cables at the point of entry and exit from their outer casing.

Fig. 29

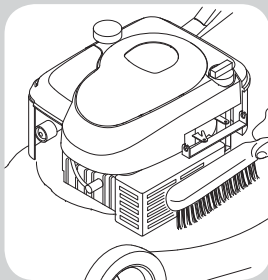

Fig. 30

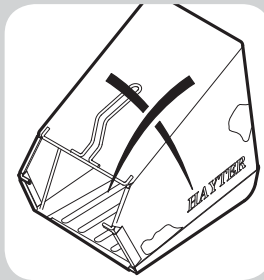

Fig. 31

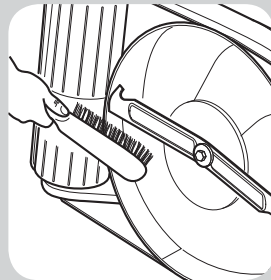

Fig. 32

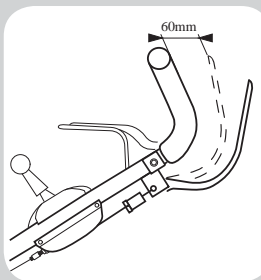

Fig. 33

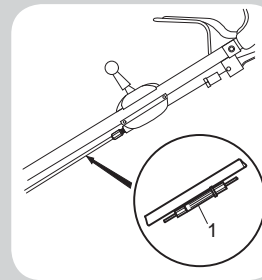

Fig. 34

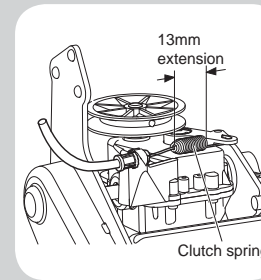
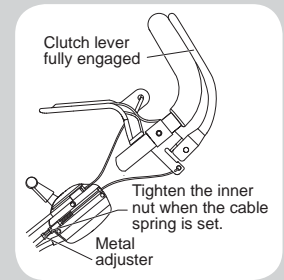

Fig. 35



# MOWER MAINTENANCE

## Cutterblade Removal

To prevent injury it is wise to seek assistance before turning the mower on its side.

Drain the fuel by running the engine until the fuel tank is empty and the engine stops. Remove the spark plug lead and allow the engine to cool. Turn the mower on its left hand side and ensure that the air cleaner side of the engine is uppermost.  
*(Refer fig.36)*

Firmly grip the end of the cutterblade (2) with a gloved hand and remove bolt (1), spring washer (2) and distance piece (3) securing the cutterblade with a 9/16" A/F spanner.  
*(Refer fig. 37)*

**To prevent accidents never work on the cutterblade unless the spark plug lead has been removed. The cutterblade has sharp edges. ALWAYS wear strong work gloves to protect your hands when working on the cutterblade. DO NOT rotate tools towards the cutting edges to avoid the risk of injury should the tool slip. ALWAYS use genuine Hayter replacement parts.**

The condition of the cutterblade and its mounting arrangement should be checked regularly for signs of wear or damage. Ensure that the cutterblade is not bent or cracked.

A damaged cutterblade that is out of balance will vibrate excessively and may break. DO NOT use an unbalanced cutterblade.

Regularly check that the bolt securing the cutterblade is tightened to the specified torque of 54 Nm.

Replace the cutterblade every 2 years or sooner or excessively worn or damaged.

## Cutterblade Assembly

Assemble the cutterblade with the turned up edges facing towards the engine. Secure the cutterblade using the bolt (1), spring washer (2) and distance piece (3).  
*(Refer fig. 37)*

## Cutterblade Sharpening

A slightly worn cutterblade may be re-sharpened. Both blade edges must be sharpened equally to ensure balance. Sharpen the cutterblade every 25 mowing hours or more frequently if conditions require. Remove the cutterblade from the mower and clean using a brush and water.

Inspect the cutterblade for signs of damage. Sharpen both cutting edges with a flat file to restore performance.  
*(Refer fig.38)*

Ensure that the cutterblade is balanced. Use a screw driver with a round shaft to support the cutterblade through its centre hole. Hold the cutterblade horizontal and then release. A balanced cutterblade will remain horizontal.  
*(Refer fig.39)*

If the cutterblade is not balanced the heavy end will rotate downwards. Sharpen the heavy end until the cutterblade is correctly balanced.  
*(Refer fig.40)*

Fig. 36

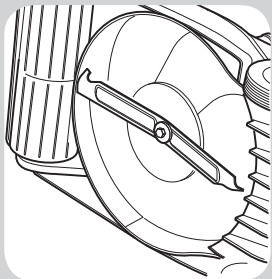

Fig. 37

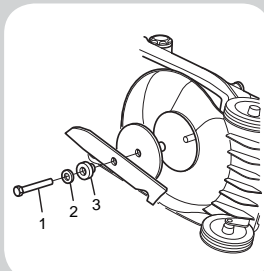

Fig. 38

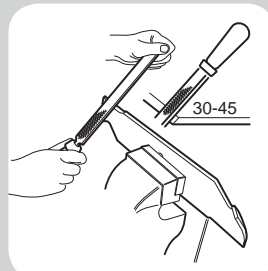

Fig. 39

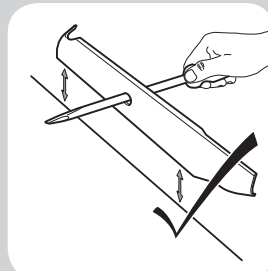
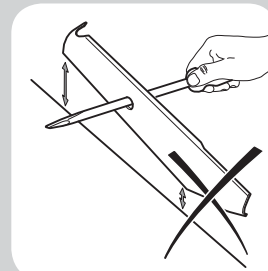

Fig. 40



# MOWER MAINTENANCE

## Storage

Ensure that the cables do not become trapped at the pivot points when collapsing the mower for storage.

To store the handlebar unscrew the 2 small securing knobs sufficiently to allow it to be pivoted forwards to rest against the mower.

Take care to ensure that the control cables do not become snagged at the pivot point and depress the engine stop lever to prevent it being damaged through contact with the engine.

*(Refer fig.41)*

Engines stored in excess of 30 days need to be protected with Briggs & Stratton fuel additive or drained of fuel to prevent gum from forming in the fuel system or on essential carburettor parts.

To ensure your mower is maintained in good working order it is important that the following procedure is adopted. Refer to the Maintenance section as necessary.

- Drain fuel from the engine by operating the engine until it stops.
- Disconnect the spark plug lead.
- Change the engine oil.

- Remove the engine spark plug and pour 15ml of engine oil into the engine cylinder and replace the spark plug. Do not exceed the stated volume of oil as engine damage may occur on re-starting. Do not replace the spark plug lead. Slowly pull the engine start-grip once to crank the engine. This will distribute the oil and help prevent engine corrosion.
- Clean grass and debris from the engine cylinder, cylinder head cooling fins, under top cowl, around and behind exhaust / exhaust guard and ensure that the grassbag is clean.
- Lubricate the mower and treat metal parts with a water repellent anti-corrosion product.
- Cover the mower with a protective sheet and store it in a dry, ventilated area.

## Battery Charging (491 only)

- **PREVENT ACCIDENTS: ALWAYS charge the battery in a well ventilated area.**
- **NEVER charge the battery near naked flames or direct heat.**
- **ALWAYS switch off the main electricity supply before disconnecting the charger from the battery.**

- **ALWAYS use the battery charger supplied with the mower.**

- Battery charging should not be necessary during normal use. The engine operation will automatically charge the battery. If the mower is stored for a long period recharging the battery may be necessary to permit electric starting.

- To recharge the battery: Disconnect the battery lead from the mower lead and then connect the battery to the charger.

- Connect the charger plug to the main electricity supply and switch on to charge the battery for a fourteen hour period.

*(Refer fig.42)*

- Disconnect the battery lead from the charger and then connect the battery to the mower lead.

- Before storing your mower away for long periods of time or for the winter, ensure that you have disconnected your battery. Store it in a dry place that isn't susceptible to temperature variants.

**IMPORTANT - PREVENT DAMAGE: NEVER connect the battery charger to the engine lead as this will cause the charger to be permanently damaged. Chargers damaged in this manner will not be replaced under warranty.**

Fig. 41

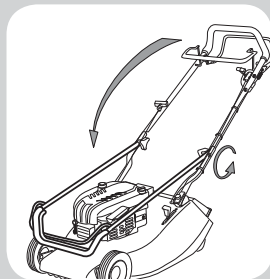
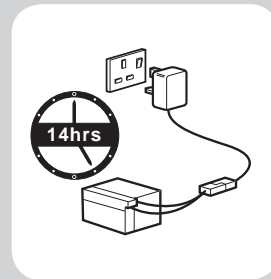

Fig. 42



# MOWER MAINTENANCE

## **Battery Disposal**

### **PREVENT ENVIRONMENTAL DAMAGE.**

*(Refer fig.43)*

**The battery and charger have a separate collection mark.**

**Indicates that for disposal of the battery and battery charger they must be taken to an authorised disposal site. They must not be disposed of with general waste.**

EU Directive 2002/96/EC classifies these products as electrical or electronic equipment.

- These products should not be disposed of as unsorted municipal waste.
- They should be taken to a designated collection point or recycling centre and handled according to national laws in the area.
- The consumer has a critical role in returning waste electronic / electrical equipment for recycling and disposal.
- Recycling keeps these products out of the municipal waste stream.
- The crossed-out bin symbol is a reminder to follow these points.

- Please contact your local authority or local dealer and ask for further details regarding the correct method of disposal.

*Fig. 43*



# *LAWN CARE CALENDAR To be used as a guide only*

## **January**

There is very little work to do this month apart from brushing away leaves. Keep off the grass if frozen or waterlogged.

## **February**

Rake the grass thoroughly. Spike the lawn to aerate and stimulate soil organisms and root growth and apply lawn sand if necessary.

## **March**

The yearly lawn work programme really starts this month. As soon as the ground conditions are suitable, the first cut can be made. The first cut should merely “top” the grass as close cutting at this stage could result in severe yellowing or browning. Two cuts are generally sufficient this month.

## **April**

Mow often enough to stop grass growing away. Dig out patches of coarse grass or resistant weed. Re-seed bare patches.

## **May**

Keep mowing increasing the frequency as required. Treat with selective weed killers or combined weed/feed preparations if you did not feed the lawn in April.

## **June**

Summer mowing should now be under way. It should be necessary to mow the lawn twice a week. Raking before mowing is important this month as the combined action keeps runners of clover under control. Water the grass if necessary, and remember to soak thoroughly.

## **July**

Treat the grass with the second application of fertiliser or weed killer/fertiliser. Water when necessary and rake occasionally. As a general rule the grass clippings should be removed each time you mow. If weather conditions are dry and hot and the grass is weed free, leave the clippings on the lawn to help maintain ground moisture.

## **August**

Keep mowing regularly and watering as necessary. Fill any cracks caused by drought with a mixture of sharp sand and soil. In dry weather conditions leave the grass longer to help retain ground moisture.

## **September**

Raise the height of cut to allow the grass to thicken and protect the roots from the winter frost and snow.

## **October**

Rake out the thatch from the turf and spike the lawn to assist in drainage. Brush in peat and sharp sand.

## **November**

Use a stiff broom to disperse worm casts before mowing. Keep turf free from leaves.

## **December**

Apart from brushing away leaves, December is a slack end of a busy year. Keep off the lawn if it is very wet or frozen.

## **Lawn Stripes**

The way to achieve a neat striped effect is for the lawn being cut in parallel stripes, alternate stripes being mown in opposite directions. A much more important routine is to cut at right angles to the line of the previous mowing. If the work has been carried in a north-south line, then the next cutting should be in an east-west direction. The cross-cutting keeps down the coarse weed grasses.

**To prevent grass damage do not remove more than one third of the grass height in one cut.**

# TROUBLE SHOOTING

PROBLEM	CAUSES	CORRECTIVE ACTION
<b>Engine will not turn over</b>	Engine stop lever released	Operate engine stop lever
	Incorrect oil level	Check oil level
	Obstruction under deck	Remove obstruction
	Battery discharged (if fitted)	Charge battery
<b>Engine smokes</b>	Excess oil	Check oil level
	Air cleaner cartridge oil soaked or blocked	Service air cleaner
<b>Engine runs then stops</b>	Fuel starvation	Fill fuel tank / Turn fuel shutoff valve to the 'ON' position
	Fuel cap vent blocked	Clean fuel cap vent
<b>Engine will not start</b>	Engine under load	Raise the height of cut
	Incorrect / contaminated fuel	Drain tank and fill with correct fuel
	Spark plug lead disconnected	Connect spark plug lead
	Engine brake not released	Operate engine brake lever
	Faulty spark plug	Clean and adjust the gap or replace
	Battery discharged (if fitted)	Charge battery
	Wiring fault	Check wiring
	Fuel shutoff valve in the 'OFF' position	Turn fuel shutoff valve to the 'ON' position
<b>Engine runs rough</b>	Spark plug lead becoming disconnected in use	Connect spark plug lead
	Faulty spark plug	Clean and adjust gap or replace
	Air cleaner blocked	Service air cleaner
	Incorrect / contaminated fuel	Drain tank and fill with correct fuel

PROBLEM	CAUSES	CORRECTIVE ACTION
<b>Engine vibrates excessively</b>	Mounting bolt loose	Tighten bolt
	Cutterblade bolt loose	Tighten bolt
	Cutterblade out of balance	Balance cutterblade
	Bent crankshaft	Consult your dealer
<b>Uneven cut</b>	Undulating ground conditions	Change direction of travel
	Cutterblade worn	Sharpen cutterblade
	Cutterblade out of balance	Balance the cutterblade
	Wheels/roller damaged	Inspect and replace as necessary
<b>Discharge chute blocks</b>	Grass is wet	Mow dry grass
	Cut height too low	Increase cut height
	Grassbag full	Empty grassbag
	No airflow through the grassbag	Clean the grassbag
<b>Mower is hard to push</b>	Cut height too low	Increase cut height
	Wheels/roller damaged	Inspect and replace as necessary
<b>Mower will not self propel</b>	Clutch out of adjustment	Adjust clutch cable
	Drive belt damaged	Replace drive belt
<b>Poor grass condition</b>	No airflow through the grassbag	Clean the grassbag
	Discharge chute blocked	Remove blockage
	Wet grass	Mow dry grass
	Grassbag full	Empty grassbag
<b>Cutterblade drive will not engage/disengage</b>	Engine stop lever not fully forward	Push fully forward to disengage

# WARRANTY

## 5 Year Limited Warranty - Home Owner 90 Day Warranty Commercial Use

Hayter Limited warrants to the original user/purchaser that this unit shall be free from defects in material and workmanship under normal use and service for a period of one year from the date of purchase. The manufacturers of the engine furnish their own warranty and services are provided through their authorised network (Refer to “Engine Warranty Statement”). To qualify for the full benefit of the warranty, the Warranty Registration Card must be returned to Hayter Limited within 14 days of purchase. If the selling dealer has not returned the Warranty Registration Card please complete and return. Subject to the conditions and exclusions noted in this limited warranty, we shall at our option, repair or replace any part covered by the warranty during the applicable period. If you are in doubt or experience any difficulty, please consult a Hayter Authorised Service Dealer for clarification.

This warranty does not apply to any unit that has been tampered with, altered, misused, abused or used for hire, and will become invalid if non genuine Hayter parts are fitted. This warranty does not cover for minor mechanical adjustments unless they are due to defective material or workmanship. Consult the Owner’s Handbook or a Hayter Authorised Service Dealer for assistance when making these adjustments.

### Extended 5 Year Warranty

To qualify for the extended warranty period (second, third, fourth and fifth year) of the five year limited warranty the machine must have an annual service carried out by an Authorised Hayter Service Dealer. These services should be carried out within 12, 24, 36 and 48 months of the date of purchase. Please note that these services will be charged at a rate agreed between you and the Authorised Service Dealer.

Excluded from the extended warranty period are those items which are subject to normal wear and tear including but not limited to, tyres, wheels, cutterblades, belts, cables, grassbags, batteries and other consumable wearing parts.

### Commercial Use

Machines used commercially are excluded from the above warranty. A warranty period of 90 days applies.

### Lifetime Warranty Against Crankshaft Bending

All consumer machines which are fitted with a genuine Hayter Friction Disc as original equipment before use, are covered by a Lifetime Warranty against the engine crankshaft bending. Note: friction washers, Blade Brake Clutch (B.B.C.) units and other such devices are excluded from the Lifetime Warranty coverage. Only machines fitted with a genuine Hayter friction disc, which are used in accordance with the recommended operating and maintenance procedures, are covered.

### Making a Claim

To make a warranty claim, return the unit to a Hayter Authorised Service Dealer along with proof of purchase stating the machine serial number and date of purchase. The service receipt(s) or stamped service card must be produced as proof of entitlement to the extended warranty period. Subject to the conditions and exclusions in this limited warranty, the Authorised Service Dealer will, at our option, repair or replace any warranted part within the duration of the warranty period.

This limited warranty gives you specific legal rights and is in addition to any statutory rights to which you may be entitled and your statutory rights are not affected by this warranty. If you need additional information concerning this written warranty, or assistance in obtaining services, please write to: HAYTER LIMITED, Service Department, Spellbrook, Bishop’s Stortford, Hertfordshire CM23 4BU

UK ONLY: Details of your local Hayter Authorised Dealer can be found on the Hayter website [www.hayter.co.uk](http://www.hayter.co.uk) or contact: Freephone 0800 616298.

## The Information Hayter Collects

This warranty is jointly administered by Hayter Limited (Hayter) and its affiliate, Toro Warranty Company (Toro). Hayter and Toro respect your privacy. In order to process your warranty claim and contact you in the event of a product recall, we ask you to share certain personal information with us, either directly or through your local Hayter dealer.

Your personal information will be processed by Hayter in the UK. It will also be entered into the Toro warranty system, which is hosted on servers located within the United States where privacy law may not provide the same protection as applies in your country.

BY SHARING YOUR PERSONAL INFORMATION WITH US, YOU ARE CONSENTING TO THE PROCESSING OF YOUR PERSONAL INFORMATION AS DESCRIBED IN THIS PRIVACY NOTICE.

## The Way We Use Information

Hayter and Toro may use your personal information to process warranty claims, to contact you in the event of a product recall, to gauge customer satisfaction, and for any other purpose which we tell you about. We may share your information with our parent, The Toro Company, or with our affiliates, dealers or other business partners in connection with any of these activities. We will not sell your personal information to any other company. We reserve the right to disclose personal information in order to comply with applicable laws and with requests by the appropriate authorities, to operate our systems properly or for our own protection or that of other users.

## Retention of your Personal Information

We will keep your personal information as long as we need it for the purposes for which it was originally collected or for other legitimate purposes (such as regulatory compliance), or as required by applicable law.

## Our Commitment to Security of Your Personal Information

Hayter and Toro take reasonable precautions in order to protect the security of your personal information. We also take steps to maintain the accuracy and current status of personal information.

## Access and Correction of your Personal Information

If you would like to review or correct your personal information, please contact us by email at [legal@toro.com](mailto:legal@toro.com).

June 11, 2012

*NOTES*

*NOTES*

*NOTES*

*NOTES*

# SERVICE RECORDS & CUSTOMER INFORMATION

Please ensure that upon completion of each chargeable Service you retain your invoice/receipt.

## 1st Year (12 Months)

We certify that this service has been carried out by an Authorised Hayter Service Dealer

Date: \_\_\_\_\_

DEALER DETAILS

## 2nd Year (24 Months)

We certify that this service has been carried out by an Authorised Hayter Service Dealer

Date: \_\_\_\_\_

DEALER DETAILS

## 3rd Year (36 Months)

We certify that this service has been carried out by an Authorised Hayter Service Dealer

Date: \_\_\_\_\_

DEALER DETAILS

## 4th Year (48 Months)

We certify that this service has been carried out by an Authorised Hayter Service Dealer

Date: \_\_\_\_\_

DEALER DETAILS

Date of Sale:- \_\_\_\_\_

Engine Type:- \_\_\_\_\_

Engine:- \_\_\_\_\_

DEALER DETAILS

Serial no. label

## Hayter Limited

Spellbrook, Bishop's Stortford,  
Hertfordshire CM23 4BU England  
Tel: +44 (0)1279 723444 Fax: +44 (0)1279 600338  
www.hayter.co.uk