



MODEL NOS. 78445 - 390001 & UP
78475 - 390001 & UP

**OPERATOR'S
MANUAL**

PROLINE

50 in. (127 cm) Side Discharge Mower
60 in. (152.4 cm) Side Discharge Mower

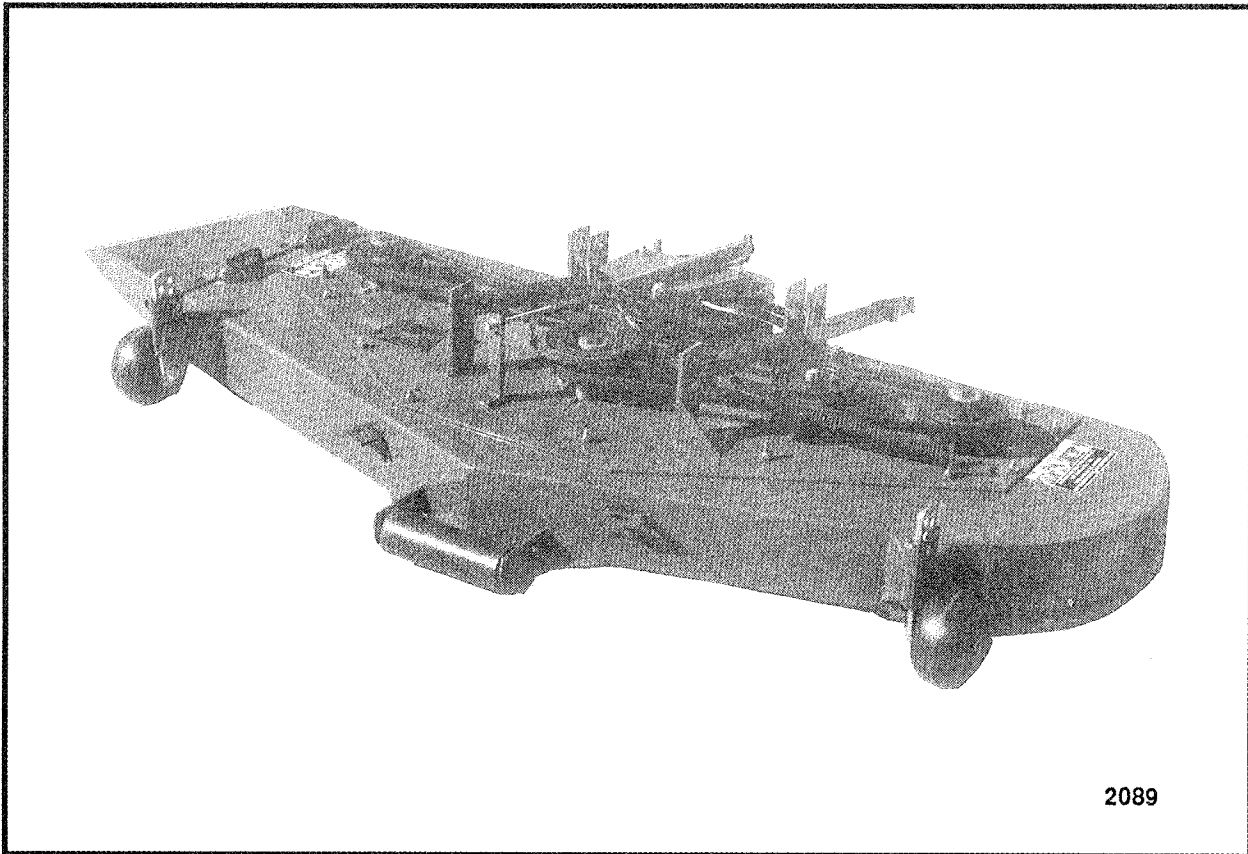

2089

CONTENTS

	<u>Page</u>		<u>Page</u>
MODEL AND SERIAL NUMBER	1	UNDERSIDE CLEANING	4
INSTALLATION	1	MOWER DRIVE BELT REPLACEMENT	4
POSITION MOWER UNDER MACHINE	1	MOWER SPINDLE BELT REPLACEMENT	4
MOWER ADJUSTMENTS	2	MOWER REMOVAL	5
Drive and Spindle Belts	2	OPERATION	5
Level Mower	3	Mowing Speed	5
GAUGE WHEELS (60" Mower Only).....	3	Mowing Height	5
BLADE MAINTENANCE	4	GENERAL CARE AND STORAGE	5
MOWER LUBRICATION	4		

MODEL AND SERIAL NUMBER

A Model and Serial Number identifies your Toro Wheel Horse attachment. These numbers should always be referred to when consulting with your dealer or factory concerning service, replacement parts, or questions you may have. If Model and Serial number plate is removed during repair operations it should always be replaced. For your reference, record number from Model and Serial Number Plate on your attachment.

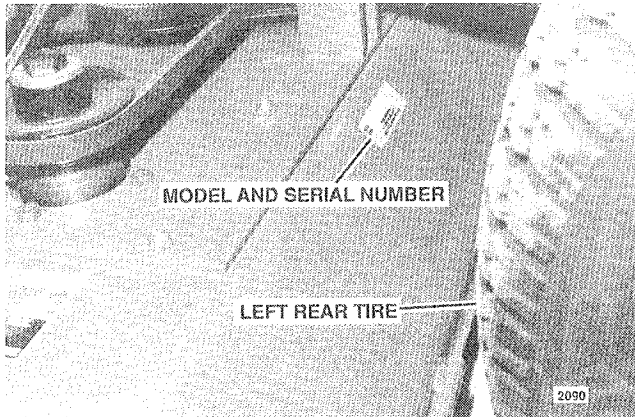
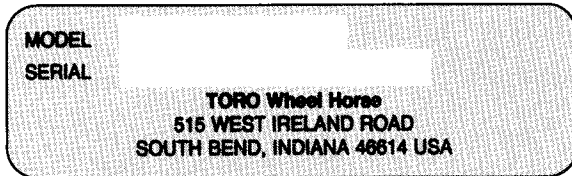

Model And Serial Number Location

INSTALLATION

Install discharge chute to mower using two 3/8-16 x 3 3/4 bolts, springs and locknuts. Hooks on springs must be positioned as shown in Figure 1. Check that discharge chute moves freely and springs hold chute in down position.

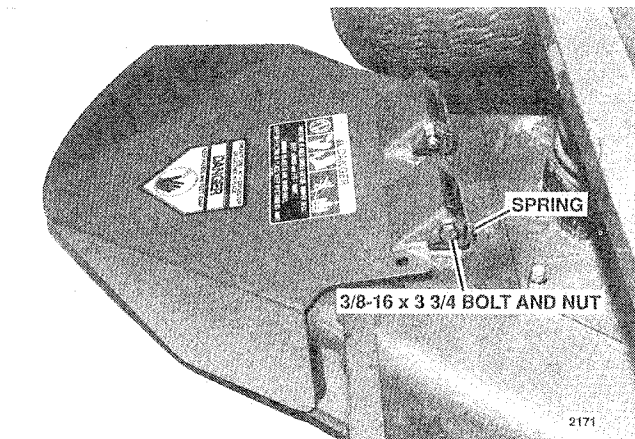

FIG. 1. Install Discharge Chute

Locate two supplied stabilizer bars and attach to middle holes of front mower brackets using two 3/8 x 1 1/4 clevis pins and two hairpin cotters (Fig. 2).

Obtain supplied belt tensioning swing arm, retaining ring,

drive belt, tensioning spring, eyebolt, two 3/8-16 jam nuts and 3/8 flat washer. Install swing arm on mower deck pivot and secure with retaining ring (Fig. 3).

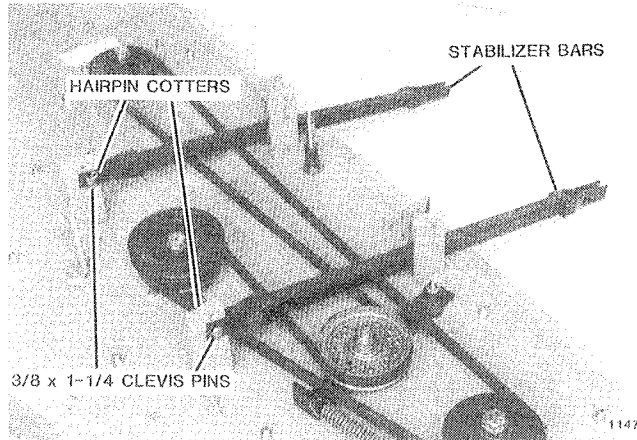

FIG. 2. Install Stabilizer Bars

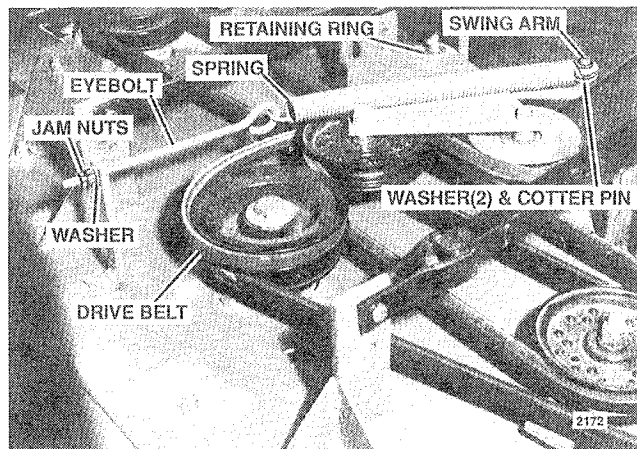

FIG. 3. Install Mower Belt Tensioning Swing Arm, Spring and Drive Belt

Install eyebolt through mower deck bracket and secure loosely with flat washer and two jam nuts. Attach tensioning spring between swing arm and eyebolt (Fig. 3).

Route drive belt through swing arm idler pulleys and around mower drive pulley (Fig. 3).

POSITION MOWER UNDER MACHINE

IMPORTANT

Before installation, check that all mower blade and pulley bolts are tight:

**Blade and Pulley Bolt Torque -
102-170 ft. lbs. (143-238 Nm)**

Check that mower spindles and pivot points have been lubricated. Use a pressure grease gun and #2 multi-purpose lithium grease. Grease fittings are on sides of spindles - see "MOWER LUBRICATION" section.

Remove wing nuts and washers securing footrest panel to machine. Remove footrest panel.

Lift machine with suitable lifting device and slide mower under machine. Lower machine. Support both sides of deck with 2" x 4" wood blocks. Attach stabilizer bars to machine's frame top holes using 3/8 x 1 1/4 clevis pin and hairpin cotter on both sides (Fig. 4).

NOTE:

Holes in machine's frame and mower brackets are used to adjust mowing height range and front-to-rear level. To mow in 2 1/4" to 3" cutting height range, position stabilizer bar in top holes of machine frame and middle holes of front mower brackets. Place clevis pins in top holes of rear mower brackets. For other cutting heights, see "LEVEL MOWER" section in this manual.

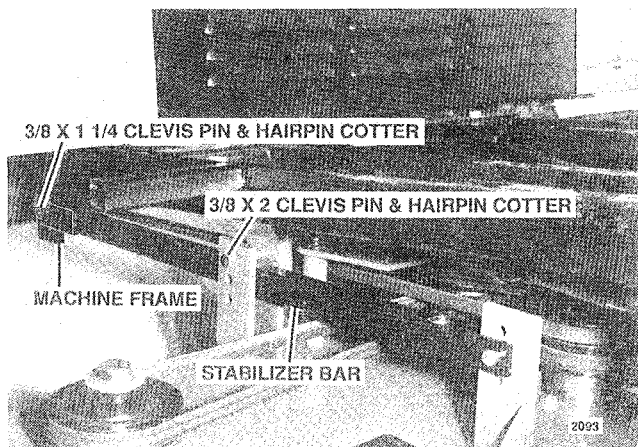

FIG. 4 Install Mower to Machine

Lift up on sides of mower deck and install 3/8 x 2 clevis pins through top holes of mower deck center stabilizer brackets - both sides (Fig. 4). Secure clevis pins with hairpin cotters.

Push foot pedal all the way forward and remove long foot pedal spring from foot pedal lever arm (Fig. 5).

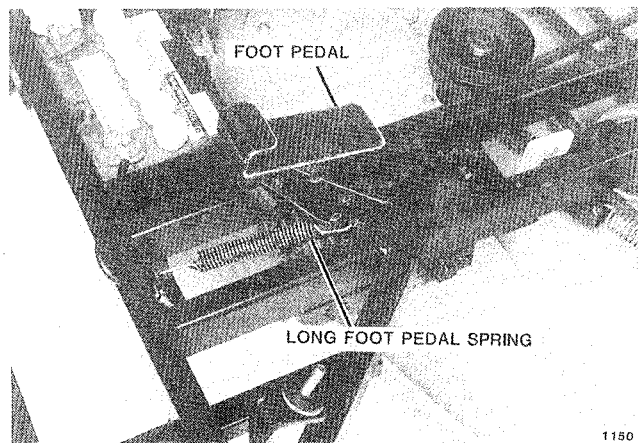

FIG. 5. Long Foot Pedal Spring

Release pedal and move it all the way rearward. Attach two side-to-side leveling chain bolts to front of mower and secure

with two 3/8 washers and locknuts (Fig. 6). Push pedal all the way forward and reinstall long foot pedal spring in lower pedal lever arm hole.

Adjust locknuts on chain bolts so that mower is level, or distance between right and left blade tip ends and level floor surface is the same.

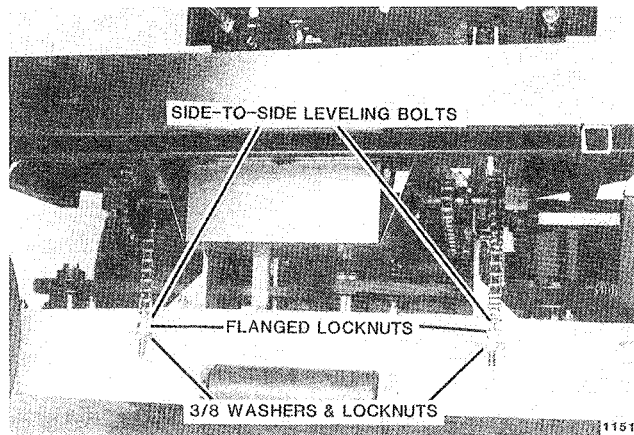

FIG. 6. Install Side-To-Side Leveling Chain Bolts

Route drive belt through back of machine's frame and onto rear idler pulleys. Rotate belt into inner groove of PTO electric clutch/brake (Fig. 7).

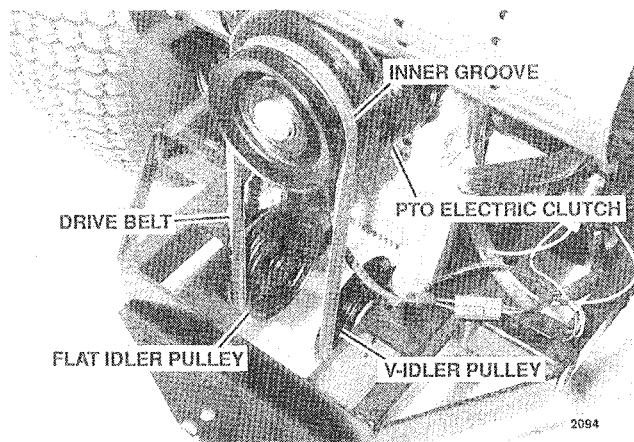

FIG. 7. Install Drive Belt on PTO Electric Clutch/Brake

Refer to machine Operator's Manual for PTO electric clutch/brake adjustment as necessary.

Perform mower adjustments.

MOWER ADJUSTMENTS

Drive and Spindle Belts

1. Check that all belts seat in pulleys.
2. Check that drive belt spring length is 15 5/16 inches (Fig. 8). to insure proper drive belt tension. Adjust locknut on eyebolt as necessary. Spindle belt spring is not adjustable.

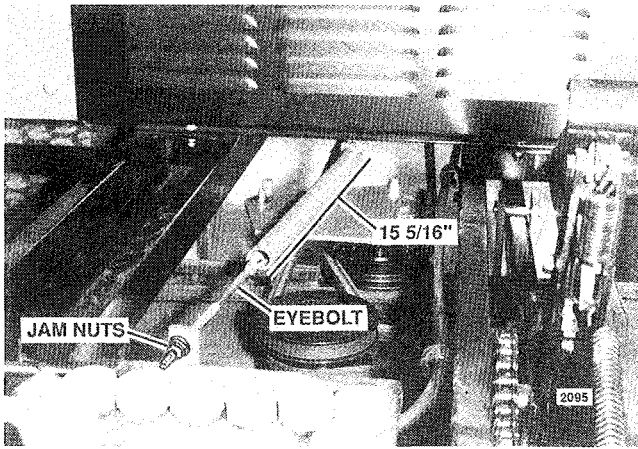

FIG. 8. Drive Belt Tensioning Spring Adjustment

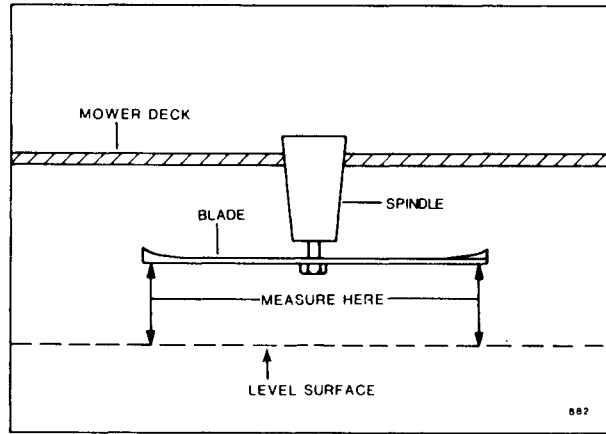

FIG. 10. Mower Level Measurement

Level Mower

1. Using a low pressure tire gauge, adjust tire pressure in all four tires.

	Front	Rear
PSI	12	6
kg/cm ²	.85	.43

2. Side-to-side leveling of mower deck is accomplished by lowering mower to mid cutting height and adjusting threaded eye bolts at front of deck (Fig. 9).

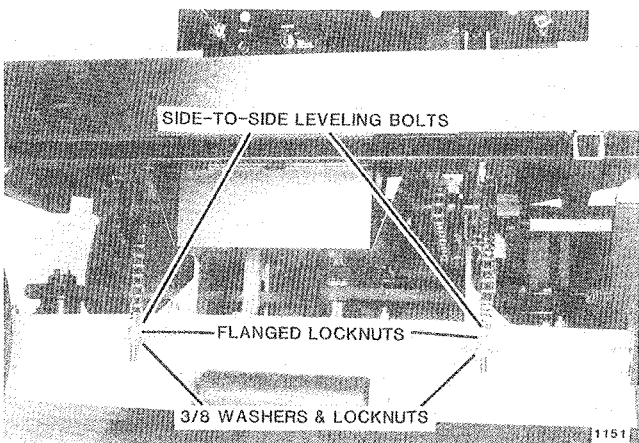

FIG. 9. Side-To-Side Level Adjustment

Park mower on a level surface and position each side mower blade tips side-to-side. Adjust chain bolts so that mower is level, or distance between right and left blade tip ends and surface is the same (Figs. 9&10).

3. Mower level front-to-rear is adjusted by changing stabilizer bar positions (Fig. 11). Always adjust each side evenly. Adjust at front and middle of stabilizer bar by removing hairpin cotter and clevis pins and raising or lowering stabilizer bar positions.

To mow at a specific cutting height range, position stabilizer bars as shown in following cutting height chart.

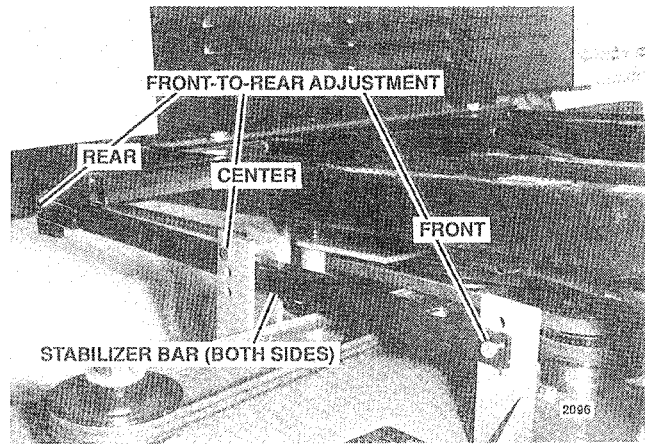

FIG. 11. Front-To-Back Level Adjustment

STABILIZER BAR LOCATIONS			
Desired Cutting Height	Rear	Center	Front
1 1/4" - 2"	Top	Top	Bottom
2 1/4" - 3"	Top	Top	Middle
3 1/4" - 4"	Top	Top	Top
4" - 5"	Top	Middle	Middle

Cutting Height Adjustment Chart

To change cutting height setting, remove foot platform, raise mower and disconnect long spring on foot pedal lever arm (Fig. 5). Remove mower drive belt and lower mower all the way down. Remove center clevis pins (Fig. 11). Position front clevis pins in holes to match desired height setting. Reinstall middle clevis pins in holes to match desired height setting. Reinstall foot pedal spring. Reinstall mower drive belt and foot platform.

NOTE:

NEVER allow rear of deck to be lower than front unless cutting height is in fully raised position, and you are mowing tall weeds. This is the **ONLY** exception.

GAUGE WHEELS (60" Mower Only)

With machine on a flat surface and height-of-cut in desired

setting, gauge wheels are to be positioned so they are approximately 1/4" to 3/8" above ground.

IMPORTANT

It is important that gauge wheels be adjusted each time height-of-cut is changed, so that deck will follow contour of ground and does not scalp turf.

1. Remove hairpin cotter and clevis pin securing gauge wheel to cutting deck (Fig. 12).
2. Move gauge wheel up or down to required setting and reinstall clevis pin and cotter pin.
3. Reposition gauge wheels each time height-of-cut setting is changed.

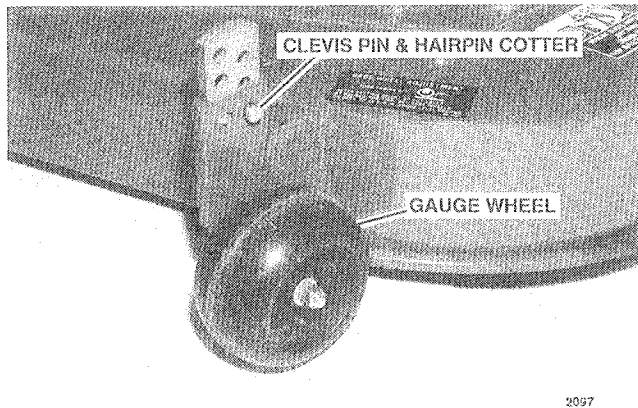

FIG. 12 Gauge Wheel Adjustment (60" Mower Only)

BLADE MAINTENANCE



Sharp edges of mower blades can cut you during blade maintenance or adjustment. Use suitable covering over cutting edges of blade to prevent bodily harm.

To obtain optimum mowing results, mower blades should be kept sharp and well balanced. To sharpen blades, remove mower from machine and invert mower. Remove blade attaching bolts and washers from end of spindles and remove blades. A short piece of 2 x 4 lumber may be placed between side of mower deck and blade to "lock" it in position when loosening attaching hardware.

File or grind blades evenly. Take care to retain angle of original cutting edge. Blade balance can be checked on an inexpensive blade balancer, available at most hardware stores.

Reinstall blades with lift area (turned up section) facing mower deck. Tighten blade attaching bolts to a torque of 102-170 ft. lbs. (143-238 Nm).

MOWER LUBRICATION

Lubricate all grease fittings (Fig. 13) after each 25 hours of operation. Mower blade spindles should be greased and all

other pivoting arms and levers should be lubricated at same intervals with light machine oil applied directly to wear surfaces. Before applying grease gun, clean grease fittings carefully to prevent dirt from being forced into fitting. After inserting grease, wipe off any excess grease.

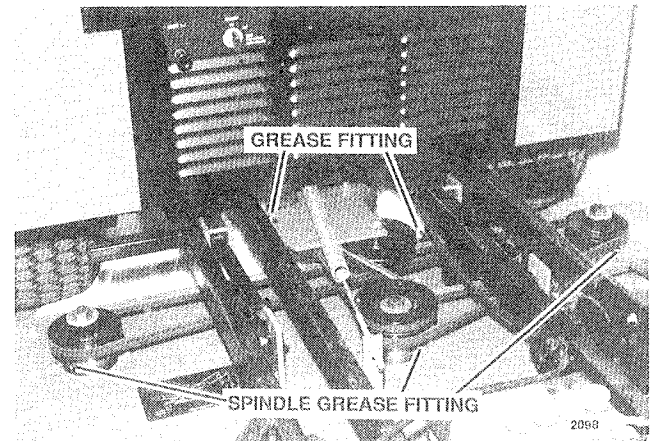

FIG. 13. Mower Grease Fittings

UNDERSIDE CLEANING

It is of vital importance to clean underside of deck frequently. Accumulation of matted clippings seriously impairs mower's ability to "lift" grass blades into cutting position and discharge clippings evenly. Matted grass clogging underside of mower is often times cause of uneven cutting. To clean mower, remove mower from machine.

MOWER DRIVE BELT REPLACEMENT

Be sure to purchase genuine Toro Wheel Horse belts for replacement purposes as these belts are designed specifically for each application.

1. To remove mower drive belt:
2. Loosen adjustment eyebolt and remove tension spring.
3. Remove belt from mower and idler pulleys.
4. Remove belt from PTO electric clutch/brake.
5. Remove belt from mower.
6. To install new belt, reverse above steps. Adjust length of tension spring to 15 5/16 inches (Fig. 8).

MOWER SPINDLE BELT REPLACEMENT

Be sure to purchase genuine Toro Wheel Horse belts for replacement purposes as these belts are designed specifically for each application.

1. To remove mower spindle belt:
2. Loosen drive belt adjustment eyebolt and remove tension spring (Fig. 8).
3. Remove drive belt from center drive pulley.
4. Remove spindle belt tension spring from idler pulley bracket.
5. Work belt off idler and spindle pulleys.
6. To install belt, reverse above steps. Adjust length of drive belt tension spring to 15 5/16 inches (Fig. 8).

MOWER REMOVAL

1. Loosen drive belt adjustment eyebolt and remove tension spring - save parts (Fig. 8).
2. Work drive belt off center mower pulley and belt tensing swing arm idlers.
3. Push foot pedal forward and remove long spring from foot pedal lever arm (Fig. 5) - save parts.
4. Support deck on both sides using 2" x 4" wood blocks. Release foot pedal and lower mower all the way down.
5. Remove stabilizer bar clevis pins and hairpin cotters from machine frame.
6. Remove two front chain bolts from mower.
7. Lift front of machine with suitable lifting device and pull mower out from under machine.
8. Lower machine.

OPERATION



Read manuals provided with machine and attachments before operating. These manuals give a detailed description of operation and point out other areas of caution. Familiarize yourself thoroughly with equipment before attempting to use it.

IMPORTANT

Every time mower is installed, check for proper operation of PTO clutch/brake. Adjustment of PTO is covered in tractor Operator's Manual. First time mower is used, or after installing a new mower drive belt, recheck belt tension after first 20 minutes of operation (allow belt to cool before checking tension).

For best operation on average lawns, operate engine at full throttle, control ground speed with transmission. Uneven cutting is often a result of excessive ground speed. To correct, reduce ground speed. Average lawns are usually cut at a height between 2 and 3 in. (5-7.6cm). Tall grass and weeds should be cut with mower in its highest position, making a second pass cutting to height desired. Always keep mower blades sharp.



Keep shields and mower discharge chute in place. Never attempt to clear discharge areas or mower blades, or make any adjustments or repairs, without first disengaging PTO clutch/brake and removing ignition key.

Mowing Speed

Mower is designed to operate most efficiently at maximum blade speeds. Speed of machine should allow mower blades to maintain this maximum speed while mowing across turf. Slow machine for cutting tall grass, grass which is heavy with moisture, or when moving uphill. If ground speed is too fast, or blade speed is too slow, mowing will be uneven because mower blades will not be able to lift grass into cutting position

as mower passes over ground.

Mowing Height

Best cutting height for your lawn has probably been established from previous experience. First time you mow, set mower to cut a little higher than you have in the past. This will help you determine best approach to uneven areas, to be sure wider cut does not result in scalping high spots. In general, recommended cutting height is 2 to 3 in. (5-7.6 cm).

Very tall or wet grass can be cut without difficulty by using a little care. Set mower in its highest cutting position and enter area slowly. If necessary, take a cut one half width of mower, overlapping previously cut area on each pass. Then, with mower set to desired height, make a finish cut over entire area.

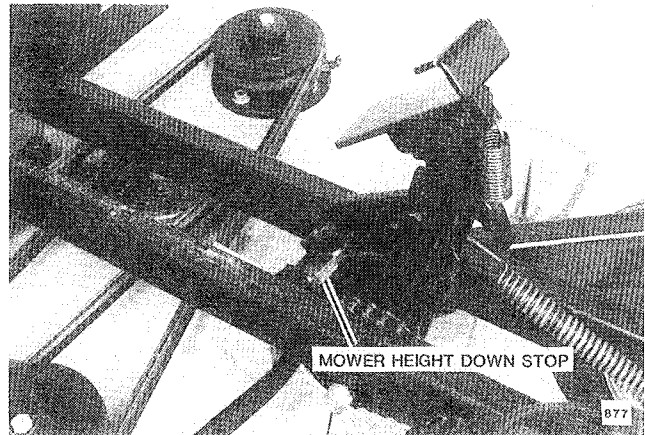

FIG. 14. Mower Height Down Stop

Mower is equipped with a height down stop (Fig. 14). Loosen bolt and move stop up or down to adjust. Retighten bolt.

GENERAL CARE AND STORAGE

Top of mower deck should be washed with a garden hose after each use. A mild automotive detergent may be used to remove stubborn dirt. After washing, allow mower to dry, then start machine and engage mower for approximately one minute to remove excess water from belts and pulleys.

Touch up painted surfaces with a fresh coat of Toro Wheel Horse Red paint, available from your authorized Toro Wheel Horse Dealer in aerosol cans.

Store mower in a clean, dry place or protect it with a weather proof cover when stored outdoors.



ProLine
Products

THE TORO TOTAL COVERAGE GUARANTEE

A One Year Limited Warranty
(A Full Two-Year Warranty for Residential Use)

What Is Covered By This Express Warranty?

The Toro Company promises to repair any TORO ProLine product used for commercial, institutional, or rental purposes if defective in materials or workmanship for a period of one year from the date of purchase. The cost of parts and labor are included as well as transportation within a 15 mile radius of a TORO ProLine Service Dealer.

What Products Are Covered By This Warranty?

ProLine products covered by this warranty include the ProLine 118, 220, 616, 620, 724 riding products and wide area walk behind mowers and their cutting decks and accessories.

How About Residential Use?

TORO ProLine products used for residential use are covered by a full two-year warranty.

How Do You Get Warranty Service?

Should you feel your TORO ProLine product contains a defect in materials or workmanship, contact the dealer who sold you the product or any TORO ProLine Service Dealer. The Yellow Pages of your telephone directory is a good reference source; look under TORO Commercial Service Dealers. The Service Dealer will either arrange service at his/her dealership or recommend another authorized Service Dealer who may be more convenient. You may need proof of purchase (copy of registration card, sales receipt, etc.) for warranty validation.

If for any reason you are dissatisfied with a Service Dealer's analysis of the defect in materials or workmanship or if you need a referral to a TORO ProLine Service Dealer, please feel free to contact us at the following address:

Toro Customer Service Department
8111 Lyndale Avenue South
Bloomington, MN 55420-1196
612-888-8801

What Must You Do To Keep The Warranty In Effect?

You must maintain your TORO Product by following the maintenance procedures described in the operator's manual. Such routine maintenance, whether performed by a dealer or by you, is at your expense.

What Does This Warranty Not Cover? and

How Does Your State Law Relate To This Warranty?

There is no other express warranty except as described above. This express warranty does not cover:

- Cost of regular maintenance service or parts, such as filters, fuel, lubricants, tune-up parts, blade sharpening, brake and clutch adjustments.
- Any product or part which has been altered or misused or required replacement or repair due to normal wear, accidents, or lack of proper maintenance.
- Repairs necessary due to improper fuel, contaminants in the fuel system, or failure to properly prepare the fuel system prior to any period of non-use over three months.
- Pickup and delivery charges for distances beyond a 15 mile radius from a TORO ProLine Service Dealer.

All repairs covered by this warranty must be performed by a TORO Service Dealer using Toro approved replacement parts.

Repair by a TORO Service Dealer is your sole remedy under this warranty.

The Toro Company is not liable for indirect, incidental or consequential damages in connection with the use of the TORO Products covered by this warranty, including any cost or expense of providing substitute equipment or service during reasonable periods of malfunction or non-use pending completion of repairs under this warranty. Some states do not allow exclusions of incidental or consequential damages, so the above exclusion may not apply to you.

This warranty gives you specific legal rights, and you may also have other rights which vary from state to state.

COUNTRIES OTHER THAN THE UNITED STATES OR CANADA

Customers who have purchased TORO products exported from the United States or Canada should contact their TORO Distributor (Dealer) to obtain guarantee policies for your country, province, or state. If for any reason you are dissatisfied with your Distributor's service or have difficulty obtaining guarantee information, contact the TORO importer. If all other remedies fail, you may contact us at The Toro Company.