



MODEL NO. 51537-49000001 & UP
MODEL NO. 51547-49000001 & UP

OPERATOR'S MANUAL

600 AIR RAKE™
700 RAKE-O-VAC®

IMPORTANT SAFETY INSTRUCTIONS

WARNING

To assure maximum safety, best performance, and to gain knowledge of the appliance, it is essential that you or any other operator of the appliance read and understand the contents of this manual before operating the appliance. Pay particular attention to the safety alert symbol  which means CAUTION, WARNING, OR DANGER — “personal safety instruction.” Read and understand the instruction because it has to do with safety. **FAILURE TO COMPLY WITH INSTRUCTION MAY RESULT IN PERSONAL INJURY, RISK OF FIRE OR ELECTRICAL SHOCK..**

SAVE THESE INSTRUCTIONS FOR FUTURE REFERENCE

BEFORE OPERATING

1. Read and understand the contents of this manual before using the appliance. Be thoroughly familiar with the proper use of the appliance.
2. Keep everyone, especially children and pets, away from area of operation. Never allow children to operate the appliance. It is not a toy. Never allow adults to operate unit without first reading the Operator's Manual.
3. Always wear safety goggles or other suitable eye protection.
4. Never operate the appliance in wet or damp conditions. **DO NOT USE IN THE RAIN.**
5. Dress properly. Do not wear loose clothing or jewelry. They can catch in moving parts. Pin up long hair so that it cannot be drawn into unit's air inlet. Always wear substantial footwear and long pants.
6. Always wear an approved dust mask when using unit in dusty conditions.
7. Use the right appliance. Do not use the appliance for any job except that for which it was intended.
8. Use appliance only as described in this manual. Use only Toro attachments with appliance.
9. To reduce the risk of electric shock, use only an approved UL extension cord recommended for outdoor use with a maximum length of 100 feet (minimum 16 gauge). Replace a damaged extension cord immediately.
10. Properly connect extension cord to power supply cord to prevent disconnection of the cords (Fig.18).
11. Avoid unintentional starting. Do not carry plugged in appliance with finger on switch.
12. Turn off all controls before unplugging.
13. Do not handle plug or appliance with wet hands.
14. Do not use appliance with a damaged cord or plug. If appliance is not working as it should, has been dropped, damaged, left outdoors, or dropped into water, return it to an Authorized Toro Service Dealer.
15. Don't abuse cord. Do not pull or carry appliance by cord. Do not use cord as a handle. Do not unplug appliance by pulling cord. To unplug, grasp the plug, not the cord.
16. Keep cord away from extreme heat, oil, and sharp edges. Replace damaged cords.
17. Never blow debris in the direction of bystanders or animals.
18. Never vacuum up anything that is burning or smoking, such as cigarettes, matches or hot ashes.
19. Do not put any object into openings. Do not use appliance with any blocked openings; keep free of dust, lint, hair, and anything that may reduce air flow.
20. Do not use appliance to vacuum up any liquids, particularly flammable or combustible liquids such as gasoline or use in areas where they may be present.
21. Never vacuum up any hazardous materials such as asbestos.
22. Always be sure of your footing. Keep a firm hold on the handle and walk, never run. Use extra care when cleaning on stairs.

SAFETY INSTRUCTIONS

23. Stop the motor and unplug the supply cord whenever you leave the appliance, before cleaning the housing, and when making any repairs or inspections.

24. When not in use, store your appliance in a dry place out of the reach of children.

25. Keep all fasteners tight to be sure the appliance is in safe working condition.

26. Never operate without proper guards or other protective safety devices in place.

27. Do not put hands or feet near rotating parts. Keep clear at all times.

28. If the appliance should start to vibrate abnormally, stop the motor, unplug the cord, and check

immediately for the cause. Vibration is generally a warning of trouble.

29. Do not operate your appliance after it has been dropped or damaged. Return it to your nearest Authorized Toro Service Dealer for inspection or repair.

30. This appliance is provided with double insulation. Use only identical replacement parts. See page 9 for Servicing Double-Insulated Appliance.

31. When servicing use only identical replacement parts. Replace or repair damaged cords.

32. This appliance is intended for residential household use only.

ASSEMBLY INSTRUCTIONS

Note: Turn off unit and unplug from electrical outlet before adding or changing attachments.

1. Thread nozzle and blower tube together with a twisting motion (Fig. 1).

2. Thread assembled tubes onto blower outlet (Fig. 1).

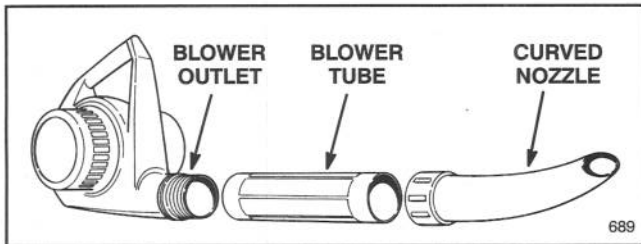

Figure 1

3. Position the inlet cover in the slotted ring so that the black pointer on the cover lines up with REMOVE triangle on the housing (Fig. 2).

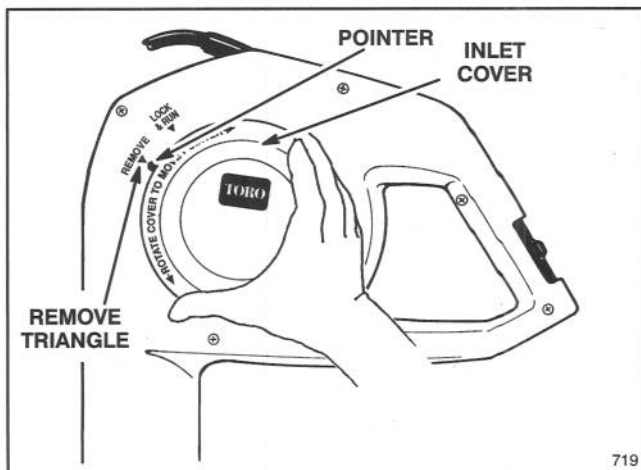

Figure 2

4. Rotate inlet cover clockwise with some extra force until you hear a "snap." The black pointer and the "LOCK & RUN" triangle on the housing must line up (Fig. 3).

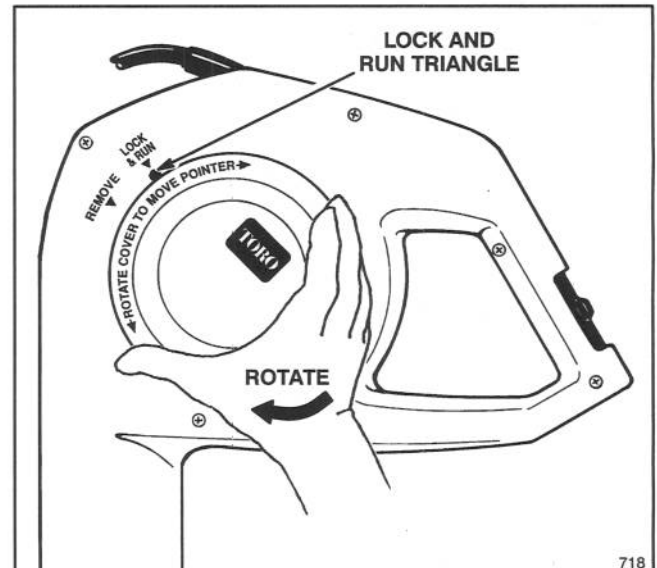

Figure 3

Note: Inlet cover must be securely locked into position, activating switch, before blower will operate.

Note: Blower is shipped with inlet cover installed.

ASSEMBLY INSTRUCTIONS

TO CONVERT TO A VACUUM (Model 51547 only) (Model 51533 Vacuum Bag Kit Optional for Model 51537)

Note: Turn off unit and unplug from electrical outlet before adding or changing attachments.

CAUTION

POTENTIAL HAZARD

Motor impeller rotates for a few seconds after blower is turned off.

WHAT CAN HAPPEN

Rotating impeller can cut or injure fingers.

HOW TO AVOID THE HAZARD

Never remove inlet cover when motor is operating or when unit is plugged in.

1. Remove the nozzle and blower tube from the blower outlet (Fig. 1).
2. Rotate inlet cover counterclockwise with some extra force until you hear a “snap.” The black pointer on inlet cover must line up with the “REMOVE” triangle on the housing (Fig. 4).

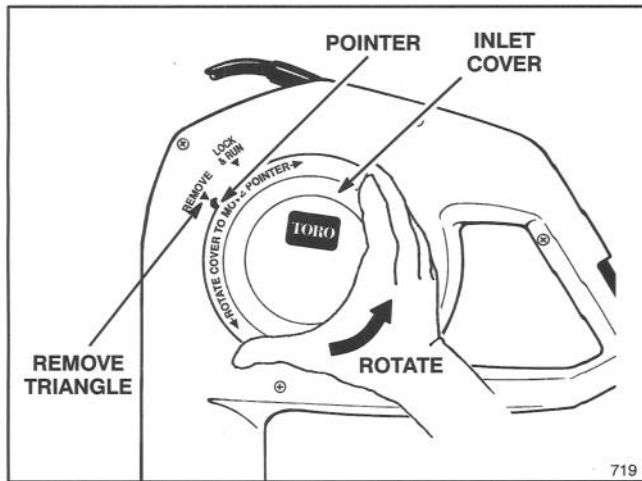

Figure 4

3. Remove inlet cover (Fig. 5).

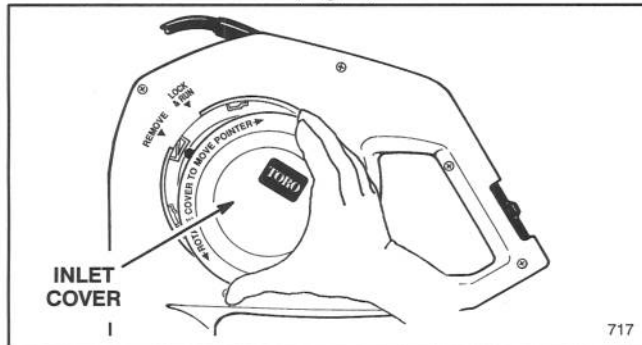

Figure 5

4. Position upper vacuum tube as shown in Figure 6. Angled tab must be to the left side of switch.

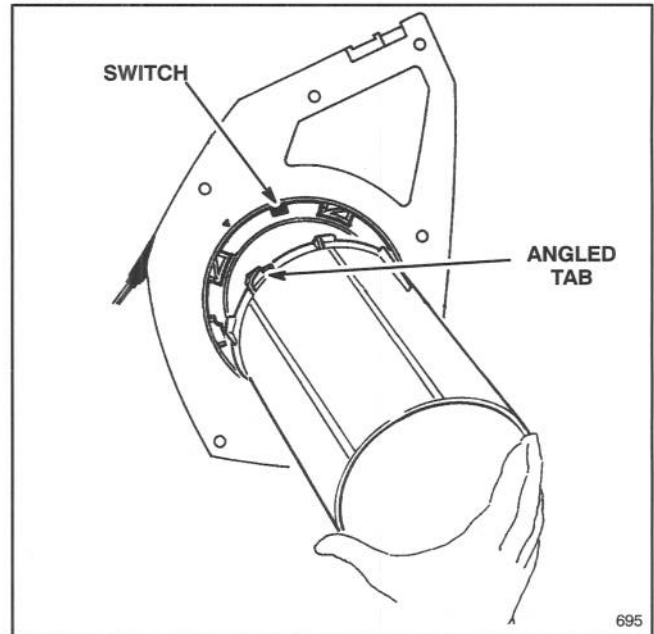

Figure 6

5. Insert tube into slotted ring in blower (Fig. 7).

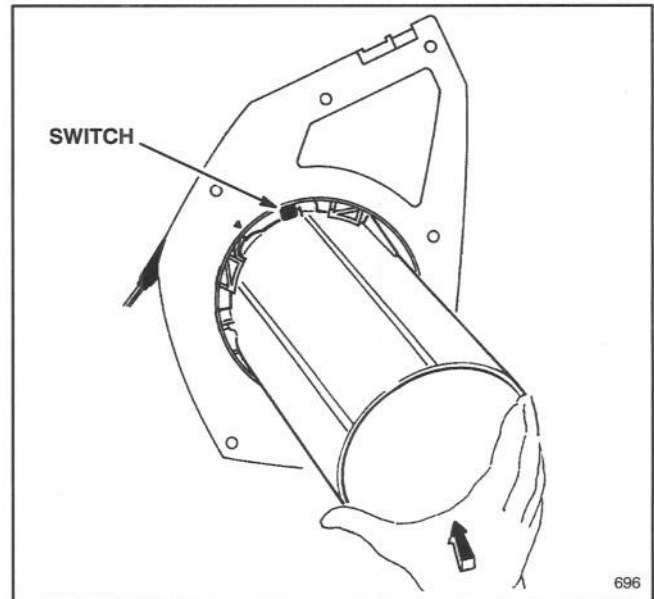

Figure 7

6. Rotate vacuum tube clockwise until the angled tab on the tube locks fully against the switch (Fig. 8). Some extra effort may be required when you rotate the tube.

Note: Upper tube mounting tabs must be securely locked into position, activating interlock switch before blower will operate.

ASSEMBLY INSTRUCTIONS

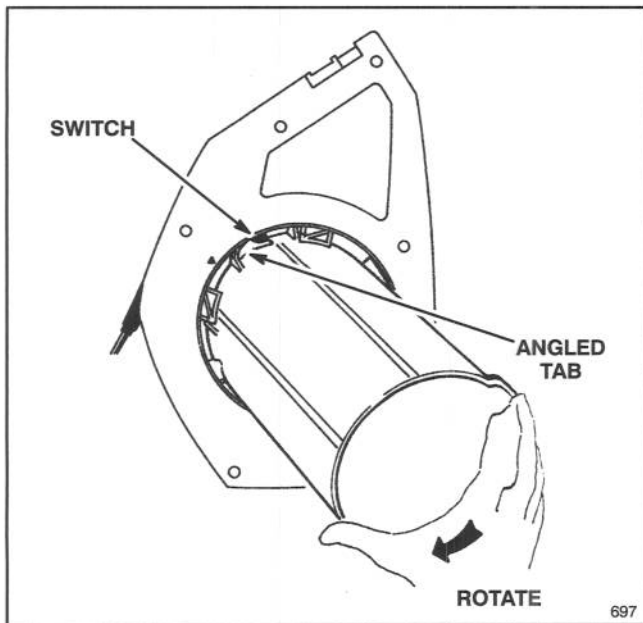

Figure 8

7. Slide upper, middle, and lower tubes together as shown in Figure 9.

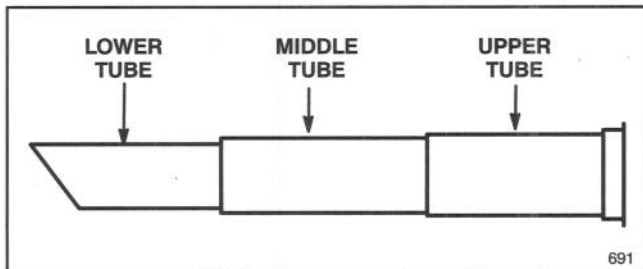

Figure 9

8. Fit opening of vac bag over outlet ribs on blower. Pull strap tightly to overlap velcro tabs (Fig. 10).

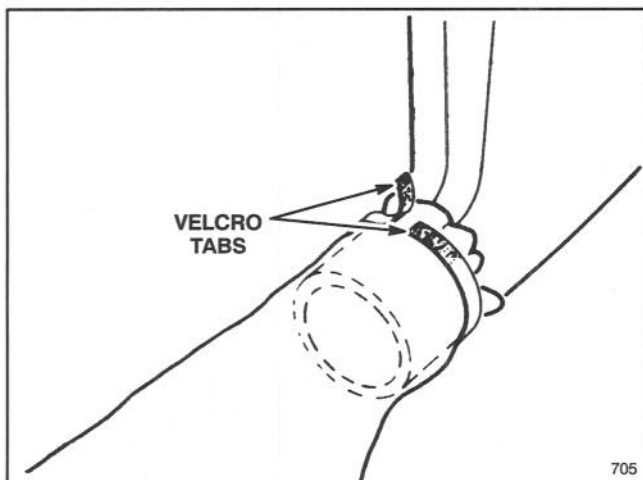

Figure 10

TO CONVERT TO A BLOWER

1. Remove the lower and middle vacuum tubes from the upper vacuum tube (Fig. 9).
2. Grasp the upper vacuum tube firmly (Fig. 11).

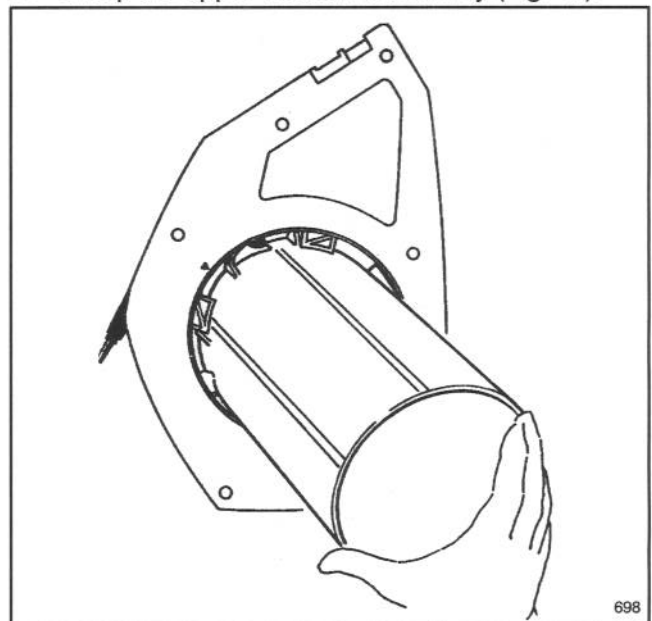

Figure 11

3. Rotate the vacuum tube counterclockwise until the tabs unlock from the blower (Fig. 12). Some extra effort may be required when you rotate the tube.

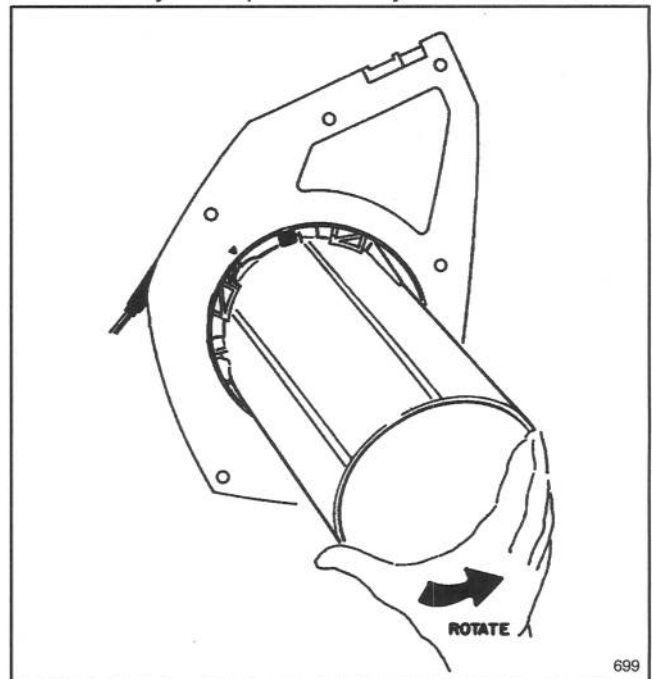

Figure 12

ASSEMBLY INSTRUCTIONS

4. Remove the vacuum tube (Fig. 13).

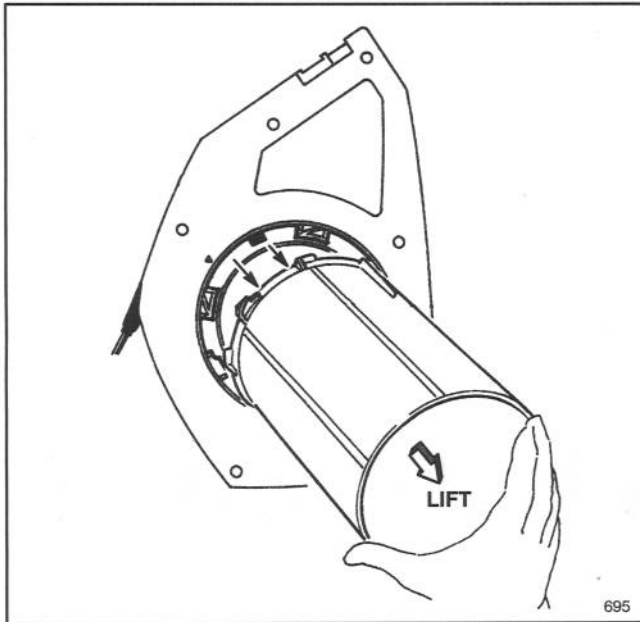

Figure 13

5. Position the inlet cover in the slotted ring so that the black pointer on the cover lines up with REMOVE triangle on the housing (Fig. 14).

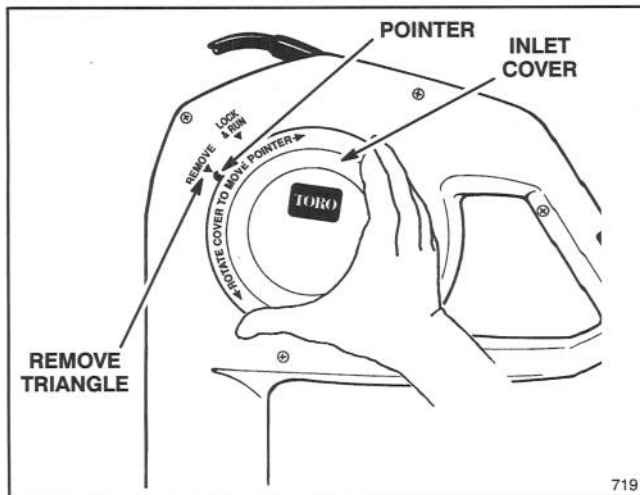

Figure 14

6. Rotate inlet cover clockwise with some extra force until you hear a "snap." The black pointer and the "LOCK & RUN" triangle on the housing must line up (Fig. 15).

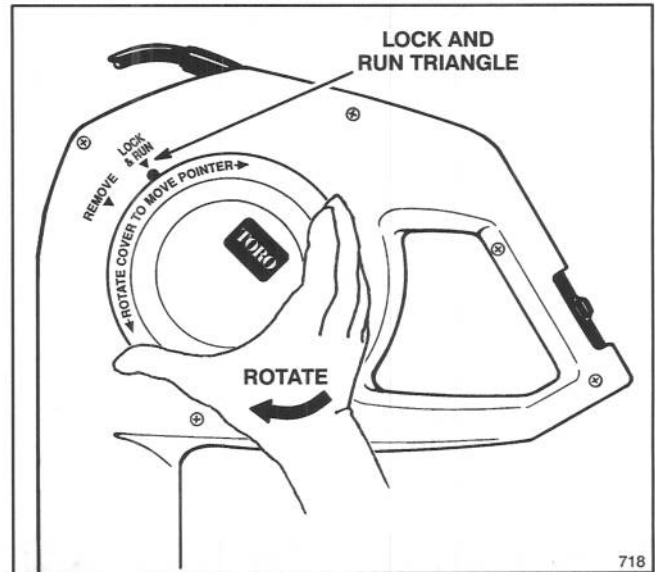

Figure 15

Note: Inlet cover must be securely locked into position, activating interlock switch, before blower will operate.

Note: Blower is shipped with inlet cover installed.

7. Thread nozzle and blower tube together with a twisting motion (Fig. 16).
8. Thread assembled tubes onto blower outlet (Fig. 16).

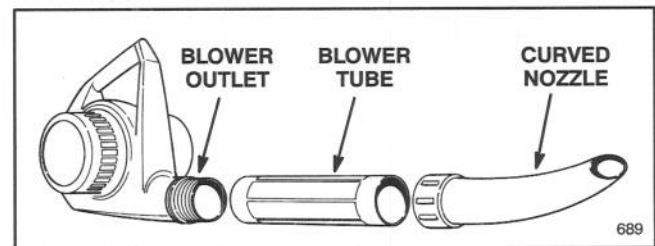

Figure 16

BEFORE OPERATING

SECURING POWER SUPPLY CORD

Note: The proper extension cord is a requirement for safe and efficient use of your appliance. Your Toro blower has been designed for use with cord sizes recommended in the Extension Cord Chart below.

EXTENSION CORD CHART

If length of extension cord is less than or equal to:	100 ft.	150 ft.
Assure wire size gauge (A.W.G.) in cord is:	16	14

Note: Use of an extension cord over 150 feet is not recommended.

1. Secure the power supply cord and a suitable extension cord as shown in Figure 18.

Note: Do not unplug extension cord by pulling on cord. To unplug, grasp the plug, not the cord.

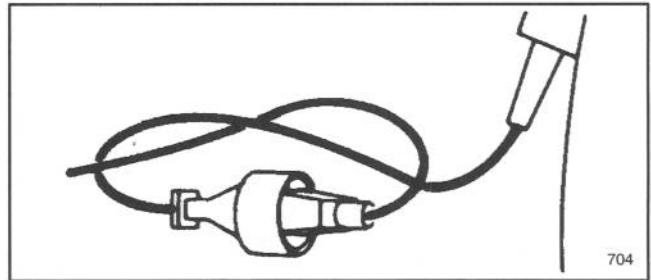

Figure 18

! WARNING

POTENTIAL HAZARD

Contact with water while operating unit could cause electric shock.

WHAT CAN HAPPEN

Electric shock can cause injury or death.

HOW TO AVOID THE HAZARD

Don't handle plug or appliance with wet hands or while standing in water.
Use only a UL listed extension cord recommended for outdoor cold weather use. Refer to Extension Cord Chart, page 6.

! CAUTION

POTENTIAL HAZARD

Debris can be thrown by unit.

WHAT CAN HAPPEN

Flying debris can injure operator or bystanders.

HOW TO AVOID THE HAZARD

Always wear safety goggles or other suitable eye protection, long pants, and shoes while operating unit.
Never operate unit near bystanders or pets, etc.
Use extra care when cleaning debris from stairs.

To reduce the risk of electric shock, this appliance has a polarized plug (one blade is wider than the other) (Fig. 17). This plug will fit in a polarized outlet only one way. If the plug does not fit fully in the outlet, reverse the plug. If it still does not fit, consult a qualified electrician to install the proper outlet. Do not change the plug in any way.

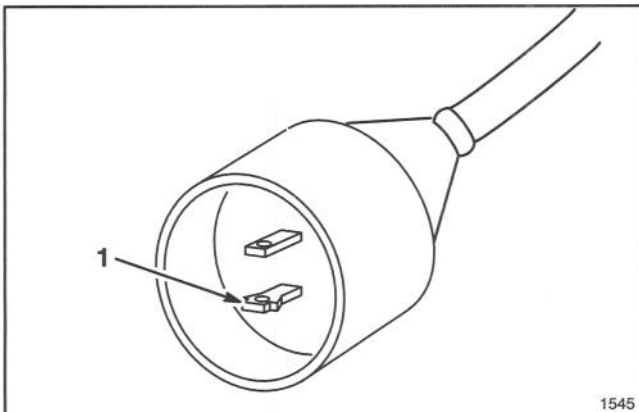

Figure 17

1. Wide blade

OPERATING INSTRUCTIONS

BLOWER

Your blower will easily blow debris from patios, walkways, garages, lawns, bushes, etc. and many hard to reach places where debris can accumulate.

Your blower features a variable inlet cover (Fig. 19) which allows you to adjust the volume of airflow by rotating the inlet adjustment cover. Low and intermediate flow will allow you to easily direct debris from open doorways, screens, etc. Experience with the unit will indicate the amount of airflow necessary for each application.

WARNING

Use only Toro attachments with appliance.

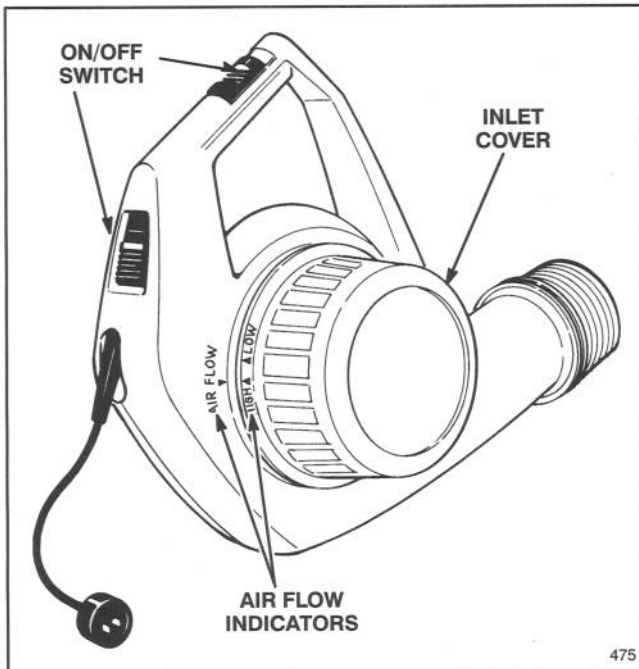

Figure 19

VACUUM (Optional on Model 51537 only)

CAUTION

POTENTIAL HAZARD

Debris can be thrown by blower vac.

WHAT CAN HAPPEN

Flying debris could cause injury.

HOW TO AVOID THE HAZARD

Never run vacuum without vacuum bag attached.

Always make sure bag zipper is closed when unit is in use.

WARNING

POTENTIAL HAZARD

Contact with water while operating unit could cause electric shock.

WHAT CAN HAPPEN

Electric shock can cause injury or death.

HOW TO AVOID THE HAZARD

Don't handle plug or appliance with wet hands or while standing in water.

Use only a UL listed extension cord recommended for outdoor cold weather use. Refer to Extension Cord Chart, page 7.

EXTENSION CORD CHART

If length of extension cord is less than or equal to:	100 ft.	150 ft.
Assure wire size gauge (A.W.G.) in cord is:	16	14

Note: Use of an extension cord over 150 feet is not recommended.

1. With vac tubes and bag attached, pick up unit with left hand holding handle and right hand on lower part of housing. Bag should be on right side. Place bag strap over shoulder, and adjust length to fit (Fig. 20).
2. Slide on/off switch to the "on" position (Fig. 19).
3. Swing unit slowly back and forth over leaves to be vacuumed. Do not force tube into pile of debris. Debris should not be stored in vacuum bag. Bag should be emptied after each use for more efficient operation. After about three uses, bag should be thoroughly cleaned. Turn bag inside out and shake out dust and excess debris.

Note: To prevent debris and dust from falling out of bag inlet when bag is being emptied, squeeze inlet and secure velcro tabs.

OPERATING INSTRUCTIONS



Figure 20

⚠ WARNING

Do not use appliance with any blocked openings; keep it free of dust, lint, hair, and anything that may reduce air flow.

IMPORTANT

- This unit is designed to pick up and shred dry leaves and other light, leafy debris.
- Do not attempt to pick up stones, gravel, broken glass, twigs, bark, acorns or pine cones as severe damage to fan blades may result.
- Do not pick up anything that is burning or smoking, such as cigarettes, matches or hot ashes.
- Do not pick up any liquids, particularly flammable or combustible liquids, such as gasoline, or use in areas where they may be present.
- Do not tip vacuum tubes upright and force feed debris into tubes.

MAINTENANCE

CLOGGING

If the unit should become clogged with debris, the obstruction can usually be cleared by turning the unit off and then promptly compressing the bag while it is still inflated, thereby forcing air back out through the inlet tubes. This reverse airflow is usually sufficient to dislodge most obstructions.

If the restriction cannot be cleared by compressing the bag, then proceed as follows:

1. Turn off and unplug unit.
2. Remove tubes.
3. Using a small stick or rod, reach carefully into impeller opening and clear out debris.

BAG CLEANING

A dirty bag will obstruct the air flow, thereby reducing the performance of your vacuum. It is recommended that the bag be turned inside out and shaken out vigorously. After shaking, the bag should be returned to its original side out and reinstalled. This procedure should be performed on a regular basis. In addition, the bag should be washed by hand once a year in soapy water.

WARNING

POTENTIAL HAZARD

Under normal usage, the bag material is subject to deterioration and wear.

WHAT CAN HAPPEN

If bag is worn, small stones or other objects could pass through bag and be thrown in direction of operator or bystanders.

HOW TO AVOID THE HAZARD

Check bag frequently. If a bag is worn, replace it with a genuine TORO bag.

IMPELLER WEAR

If a loss of performance is detected while operating blower, unplug unit, remove inlet cover and check impeller blades for wear. If blades are severely worn (Fig. 21), see your Authorized TORO Service Dealer for service and parts.

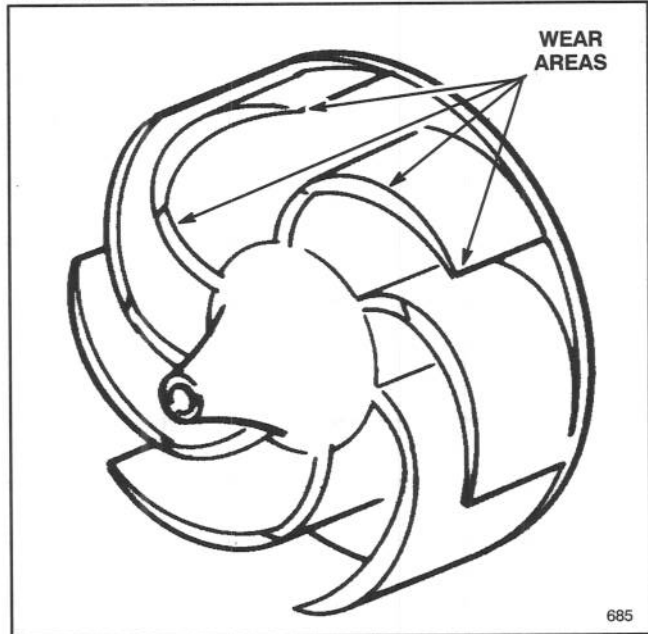

Figure 21

SERVICING DOUBLE-INSULATED APPLIANCE

In this double-insulated appliance, two systems of insulation are provided instead of grounding. No grounding means is provided, nor should means of grounding be added to the appliance. Servicing a double-insulated appliance requires extreme care and knowledge of the system and should be done only by an Authorized Toro Service Dealer who uses only identical, genuine Toro replacement parts.

PRODUCT IDENTIFICATION

A model and a serial number decal is located on the blower housing. Always refer to specific numbers on this decal in correspondence or when replacement parts are needed.

TORO SERVICE SUPPORT

If your unit requires service or maintenance, your nearest TORO Master Service Dealer is the best dealer to assist you. Refer to the "Yellow Pages" of your local telephone directory in the section titled "Lawn Mowers." TORO Master Service Dealers are listed under the TORO trademark. If you need help locating a TORO Master Service Dealer near you, call 1-800-421-9684 for assistance.



The Toro Promise

A Full Two Year Residential Use Warranty For the United States, Canada and Mexico

The Toro Company warrants this TORO Product for two years against defects in material or workmanship. To receive a replacement or repair, at Toro's option, just return the complete unit, postage prepaid, to the seller. (U.S. customers ONLY may return their unit, with proof of purchase, to any TORO Master Service Dealer or the TORO Service Center, 5300 Shoreline Blvd., Mound, MN 55364.) This warranty covers product defects only. **It does not cover incidental or consequential damages. Some states do not allow the exclusion or limitation of incidental or consequential damages, so the above limitation may not apply to you.** This warranty gives you specific rights, and you may have other rights which vary from state to state. If all other remedies fail, you may contact us at The Toro Company, Customer Service Department, 8111 Lyndale Ave S, Bloomington, MN, 55420-1196. (Do not return defective product to this address.)

COUNTRIES OTHER THAN THE UNITED STATES, CANADA OR MEXICO

Customers who have purchased TORO products exported from the United States, Canada or Mexico should contact their TORO Distributor (Dealer) to obtain guarantee policies for your country, province or state. If for any reason you are dissatisfied with your Distributor's service or have difficulty obtaining guarantee information, contact the TORO importer.