

MODEL NO. 78305 - 5900001 & UP

**INSTALLATION  
INSTRUCTIONS**

**WHEEL HORSE®**  
36 in. (92 cm) Rear Discharge Mower - GT

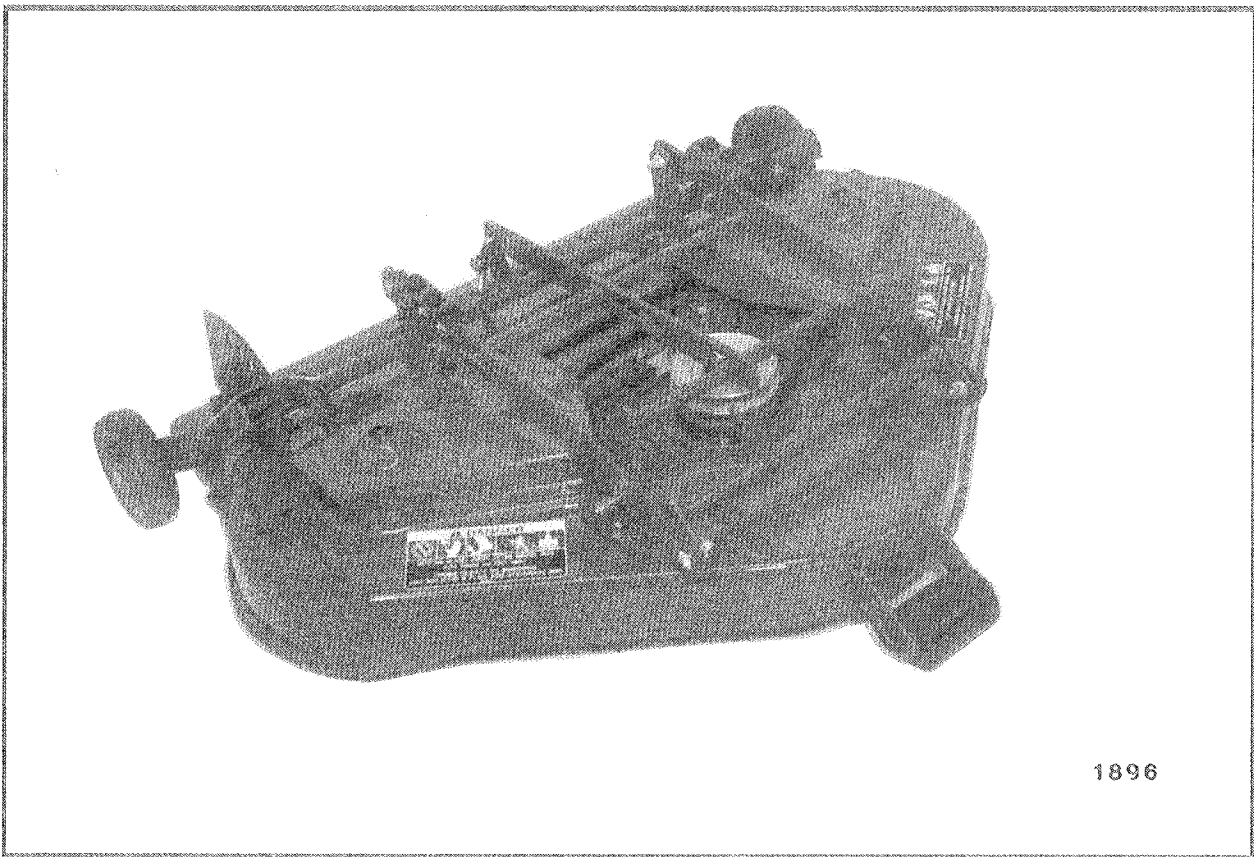

1896

# CONTENTS

	<u>Page</u>		<u>Page</u>
MODEL AND SERIAL NUMBER .....	1	REMOVAL .....	4
INSTALLATION .....	1-3	OPERATION .....	4
ATTACH MOWER TO TRACTOR .....	1	MAINTENANCE AND STORAGE .....	4-5
INSTALL FRONT PULLEY SUPPORT .....	2	LUBRICATION .....	4
INSTALL DRIVE BELT AND COVER .....	2	BLADE MAINTENANCE .....	5
CHECKING MOWER LEVEL .....	3	UNDERSIDE CLEANING .....	5
MOWER LEVEL .....	3	REPLACEMENT BELTS .....	5
TRACTOR LIFT BAR-TRUNNION AND		MOWER DRIVE BELT REPLACEMENT .....	5
LIFT ROD ADJUSTMENT .....	3	SPINDLE BELT REPLACEMENT .....	5
TRANSPORT LEVEL STOP ADJUSTMENT ..	3	GENERAL CARE AND STORAGE .....	5

## SAFETY DECALS AND INSTRUCTIONS

Safety decals and instructions are easily visible to the operator and are located near any area of potential danger. Replace any decal that is damaged or lost.

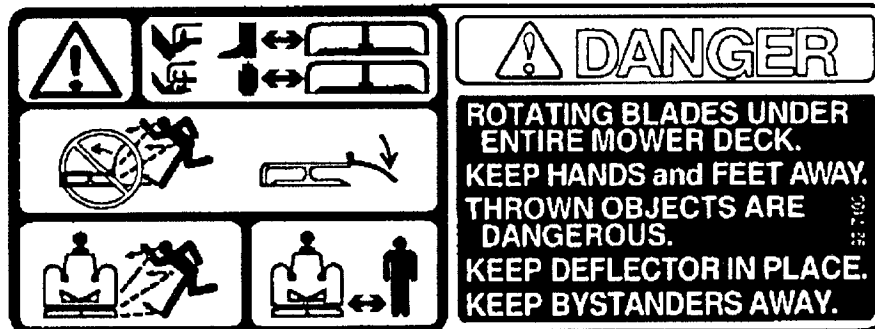

Each Side of Deck  
Part Number 92-7108



Rear of Deck  
Part Number 43-8480

## MODEL AND SERIAL NUMBER

A Model and Serial Number identifies your Toro Wheel Horse attachment. These numbers should always be referred to when consulting with your dealer or factory concerning service, replacement parts, or questions you may have. For your reference, record numbers from Model and Serial Number plate on your attachment.

MODEL _____
SERIAL NO. _____

## INSTALLATION

**IMPORTANT:** Before installation, check that all mower blade nuts are tight:  
 Blade Nut Torque 80-100 ft. lbs. (112-140 Nm)  
 Check that mower spindles have been lubricated. Use a pressure grease gun and #2 multi-purpose lithium grease. Grease fittings are on top of spindles.



Sharp edges of mower blades can cut you during blade maintenance or adjustment. Use suitable covering over cutting edges of blade to prevent bodily harm.

Place mower along right side of tractor (Fig. 1). Position height control lever in lowest position. Turn front wheels of tractor fully left. Raise tractor attachment lift.

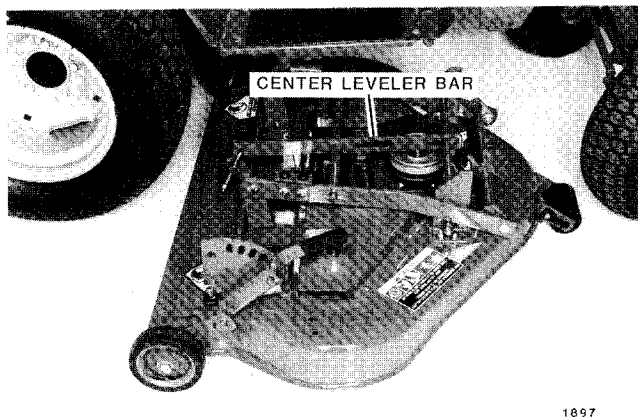

FIG. 1. Position Mower to Right of Tractor

Slide mower under tractor until mower center leveler bar is directly under right side of tractor frame.

## ATTACH MOWER TO TRACTOR

Lower tractor attachment lift. Remove washer and

hairpin cotter installed on tractor lift bar pin (Fig. 5). Align lift bar and pin (attached to tractor) with slot in mower leveler bar (Fig. 2).

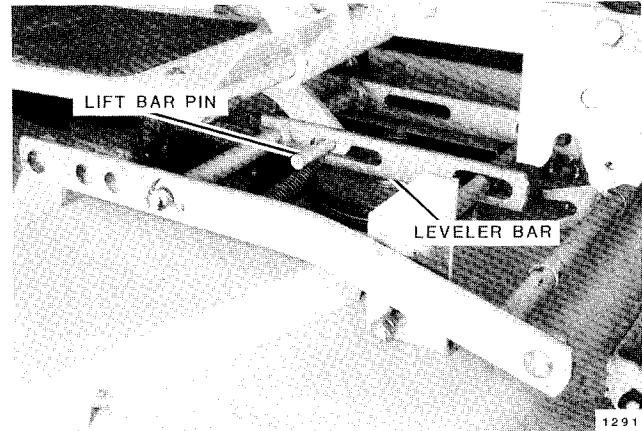

FIG. 2. Align Pin with Slot

Push mower in until it is centered under tractor.

Open mid Attach-A-Matic hitch by pushing release button in and pushing latch lever down (Fig. 3).

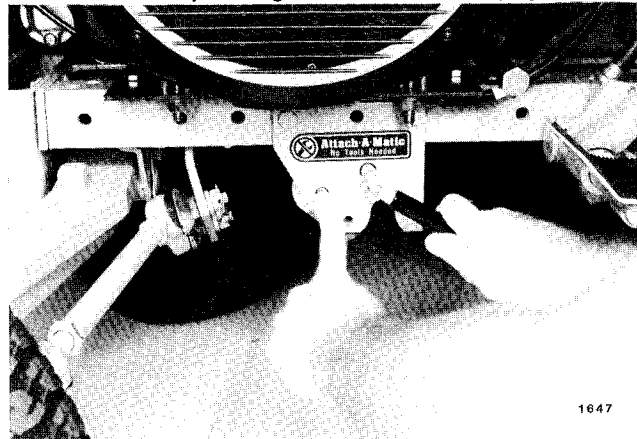

FIG. 3. Open Mid Attach-A-Matic Hitch

Adjust mower hitch so fork faces upward. Adjust mower so welded spacers are positioned between tractor hitch plates (Fig. 4).

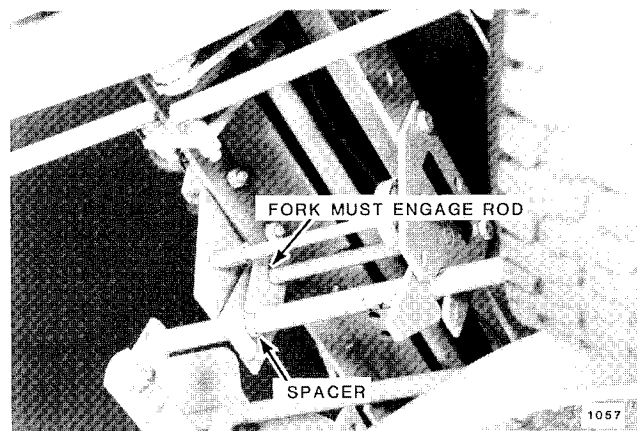
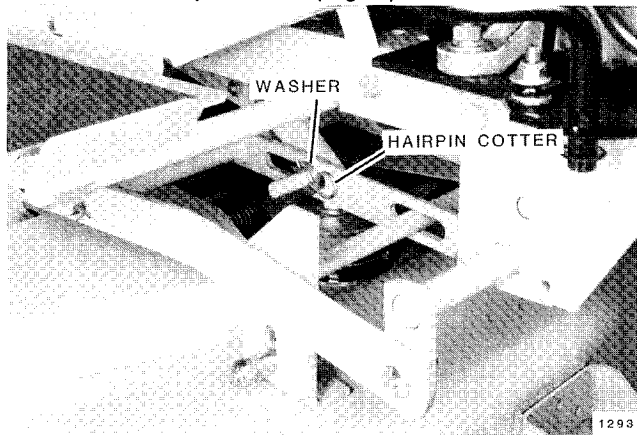

FIG. 4. Align Fork with Shaft

Secure mower to tractor with previously removed washer and hairpin cotter (Fig. 5).

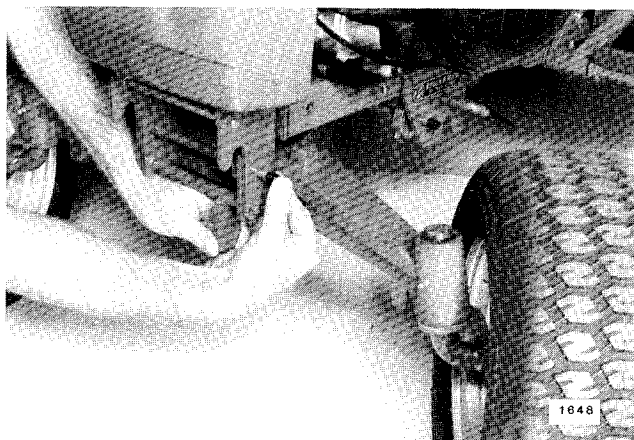

**FIG. 5. Secure Mower to Tractor Lift Bar Pin**

Lift mower with attachment lift. NOTE: When using a manual attachment lift, be sure lift handle "locks" in raised position.

Close Attach-A-Matic hitch by moving latch lever up.

#### INSTALL FRONT PULLEY SUPPORT



**FIG. 6. Open Front Attach-A-Matic Hitch**

Open front Attach-A-Matic hitch by pushing release button and pulling forward on latch handle (Fig. 6).

Insert shaft of pulley support assembly into hitch slots and push latch handle rearward to lock latch (Fig. 7).

#### INSTALL DRIVE BELT AND COVER

Turn belt tension adjustment knob all the way clockwise (Fig. 8).

Install drive belt in groove of mower drive pulley and position belt strands around idler pulleys, with inside strand in "V" pulley and outside strand making a back

bend around flat idler (Fig. 8). Place drive belt on inside groove of PTO pulley as described in tractor Operator's Manual (Fig. 9).

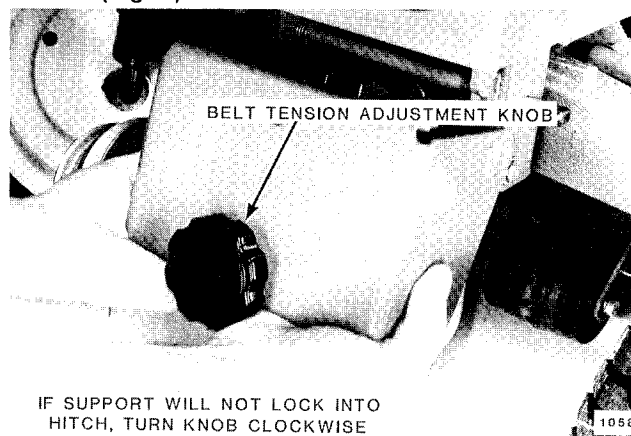

**FIG. 7. Install Pulley Support**

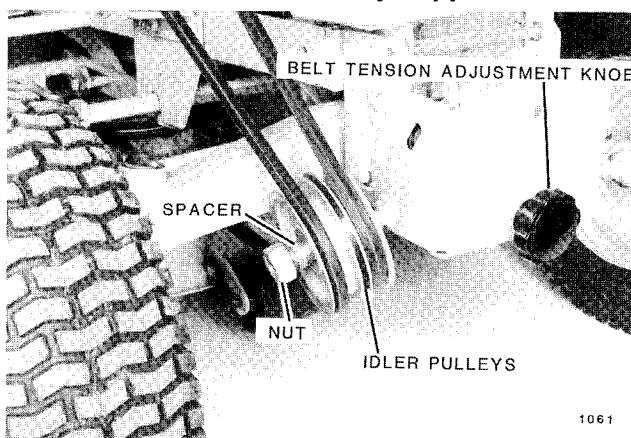

**FIG. 8. Mower Front Idler Pulleys**

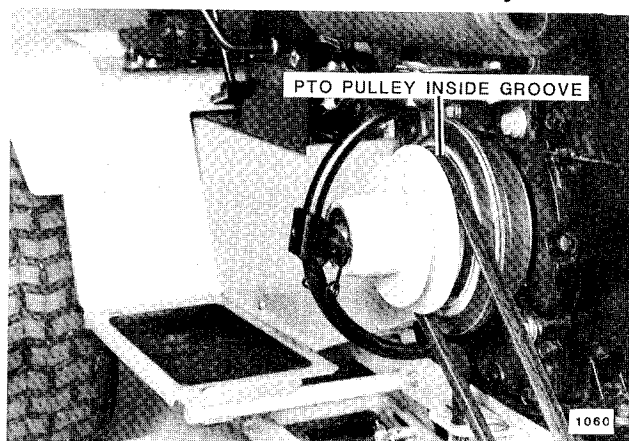

**FIG. 9. Mower PTO Pulley**

Hold pulleys in against thrust collar and adjust drive belt tension by turning adjusting knob counterclockwise until top strand of drive belt can be depressed approximately 1 inch (2.5 cm) under moderate finger pressure at mid-point between pulleys (Figs. 8 & 9).

Remove idler pulley and cover nut making sure spacer remains on shaft (Fig. 8). Install cover with pilot pin in

slot of support (Fig. 10). Reinstall cover nut and tighten.

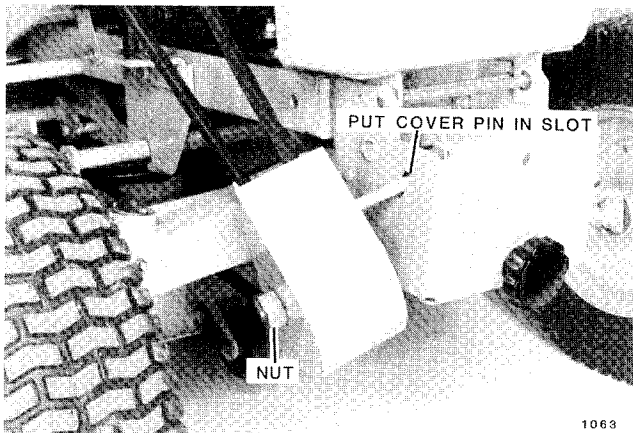

FIG. 10. Install Pulley Support Cover

## CHECKING MOWER LEVEL

For optimum efficiency, level of mowing should be checked at time of initial installation and periodically as a check, to see if alignment is maintained.

### MOWER LEVEL

Position tractor on a level surface. Adjust all four tires to 12PSI pressure. Place mower height control lever in middle cutting position.

Turn mower blades front-to-rear (Fig. 11).

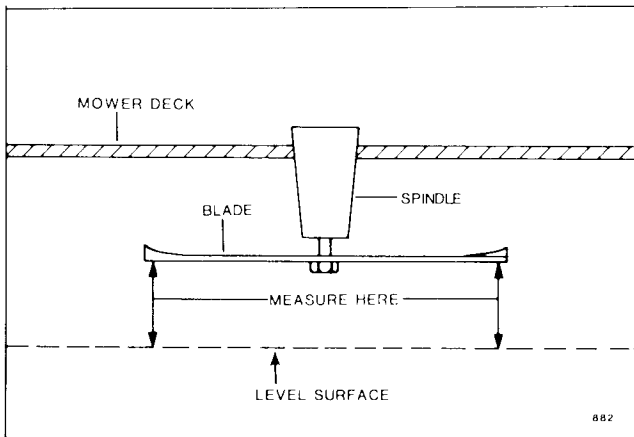

FIG. 11. Mower Level Measurement

Turn leveling adjustment nut (Fig. 12) clockwise to raise or counterclockwise to lower front of mower. Adjust so that distances from surface to front and rear of blade tips are equal to 1/8 inch high in front (Figs. 11 & 12).

Under some unusual mowing conditions, mower may leave a "streak" of uncut grass, which can be caused by

any of the following conditions:

1. Engine being operated at less than full throttle.

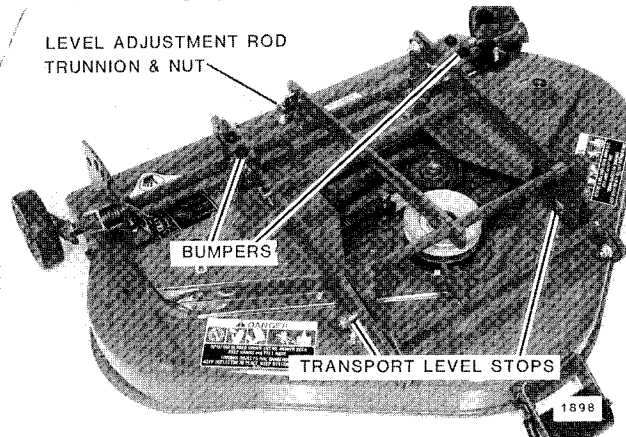

FIG. 12. Mower Adjustments

2. Dull blades or underside of mower deck clogged with matted grass.
3. Ground speed too high for conditions-adjust to 2 mph (3.2 kph), or less if necessary.
4. Striking on turns indicates turns are being made too sharply.
5. If blades have been sharpened a number of times, they may now be too short to "overlap" each other, and must be replaced.

If striking persists after the above possibilities have been eliminated as cause, adjust mower until deck is level, then turn adjustment nut "in" (clockwise) one complete turn, to shorten level adjustment rod and slightly raise front of mower.

## TRACTOR LIFT BAR-TRUNNION AND LIFT ROD ADJUSTMENT

This adjustment involves parts located on tractor (Fig. 13). Trunnion on lift chain should be adjusted so that bumpers on draft bars (Fig. 12) of mower suspension come in contact with tractor footrests when mower is fully raised, with trunnion stud in rear hole of tractor lift lever.

### TRANSPORT LEVEL STOP ADJUSTMENT

For normal operation mower level stops should be adjusted so that carriage bolt heads are set at bottom of bracket slots. If mower is not level, in fully raised position, level stops may be adjusted by moving them in bracket slots as required (Fig. 12).

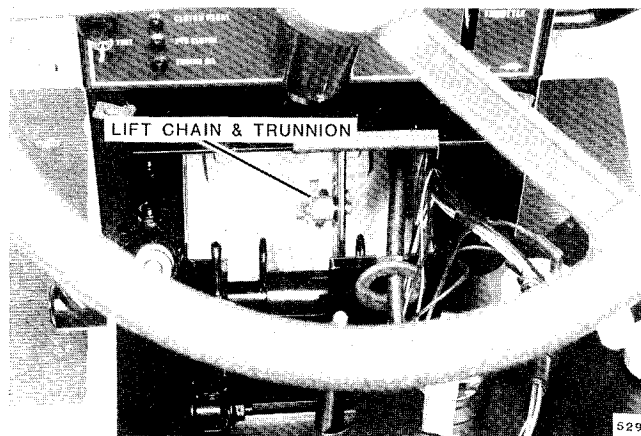

**FIG. 13. Tractor Lift Bar Trunnion and Lift Rod Adjustment**

## REMOVAL

Set mower gage wheels in lowest cutting position and lower mower with tractor lift. Turn front wheels all the way left.

Turn drive belt tension adjustment knob clockwise all the way and remove belt from mower.

Push mid-hitch lock release button in and open latch, releasing mower hitch shaft.

Remove hairpin cotter and washer from lift bar pin. Slide mower right until lift bar pin comes out of slot in leveler bar. Raise tractor lift.

Remove drive belt from PTO clutch pulley. Remove pulley support assembly by pushing front hitch lock release button in and opening latch. Drive belt need not be removed from pulley support assembly.

Slide mower out from under right side of tractor.

## OPERATION

**IMPORTANT:** Every time mower is installed, check for proper operation of PTO clutch and brake. Adjustment of PTO is covered in tractor Operator's Manual. First time mower is used, or after installing a new mower drive belt, recheck belt tension after first 20 minutes of operation (allow belt to cool before checking tension).



Keep shields and mower discharge chute in place. Never attempt to clear discharge areas or mower blades, or to make any adjustments or repairs, without first disengaging PTO clutch/brake and removing ignition key.

1. Disengage to tractor PTO clutch and start engine. Lift mower with tractor to remove weight of mower from gage wheels. **NOTE:** Never stand or rest your feet on mower.

2. Move mower height control lever to hole on quadrant corresponding to desired cutting height. This can be set for cutting heights between 1-1/2 and 3-1/2 in. (4 - 9 cm). Recommended cutting height is 2 to 3 inches (5-7.6 cm) for most mowing situations.

3. Lower mower and set engine speed at full throttle. Engage PTO clutch. Regulate ground speed with transmission to 2 -3.5 mph (3.2 -5.6 kph)\* for best cutting results on average lawns. Uneven cutting often results from excessive ground speed. To correct, reduce ground speed with transmission while maintaining full throttle setting.

4. To mow extra tall grass, raise mower to its highest position for a first cutting and use a slow ground speed. Then re-cut to normal height.

\*Average walking speed is 2.5 mph ( 4 kph).

## MAINTENANCE AND STORAGE

### LUBRICATION

Mower spindle bearings should be lubricated at 50 operating hour intervals. Use a pressure type grease gun and #2 multi-purpose lithium grease to lubricate spindle bearings. Four to six pumps of a hand type grease gun will usually fill each spindle after 50 hours use. Grease fittings are conveniently located at top of spindle shafts. Lubricate mower gage wheels every 25 hours.

Lubricate pivoting arms and levers at 25 hour intervals with light machine oil applied directly to wear surfaces. Anticlip rollers should NOT be lubricated.

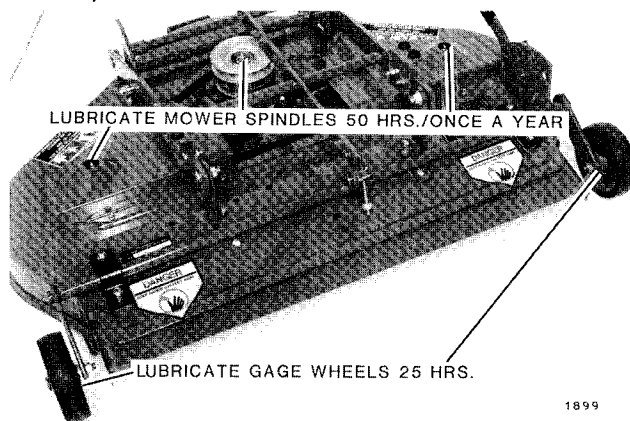

**FIG. 14. Mower Lubrication Fittings**

## BLADE MAINTENANCE



**Sharp edges of mower blades can cut you during blade maintenance or adjustment. Use suitable covering over cutting edges of blade to prevent bodily harm.**

To obtain optimum mowing results, mower blades should be kept sharp and well balanced. To sharpen blades, remove mower from tractor and invert mower.

Hold spindle hex with wrench while removing blade attaching nuts and washers from end of spindles. If spindle blade wrench is not available when servicing, a short piece of 2" x 4" lumber may be placed between side of mower deck and blade to "lock" it in position while removing attaching hardware.

File or grind blades evenly. Take care to retain angle of original cutting edge. Blade balance can be checked on an inexpensive blade balancer, available at most hardware stores.

Reinstall blades with lift area (turned up section) facing mower deck. Tighten blade attaching nuts to a torque of 80-100 ft. lbs. (12-140Nm).

## UNDERSIDE CLEANING

It is of vital importance to clean underside of mower deck frequently. Accumulation of matted clippings seriously impairs mower's ability to "lift" grass blades into cutting position and discharge clippings evenly. Matted grass clogging underside of mower is often times a cause of uneven cutting.

## REPLACEMENT BELTS

Be sure to purchase genuine Toro Wheel Horse belts for replacement purposes as these belts are designed specifically for each application.

## MOWER DRIVE BELT REPLACEMENT

Turn belt adjustment knob all the way clockwise.

Remove belt front pulley cover retaining nut and remove cover being careful not to lose pulley cover spacer. Reinstall nut finger tight to avoid possibility of pulleys and spacers coming off.

Remove belt from PTO, mower and idler pulleys and examine condition of pulleys making sure pulley grooves and bearings are in good condition.

Install replacement belt and adjust tension as outlined under "Install Drive Belt and Cover" section in this manual.

## SPINDLE BELT REPLACEMENT

Remove mower from tractor.

Remove two side belt covers and note routing of belt.

Remove belt. Check to be sure all pulleys work freely. Install a new belt in accordance with belt diagram located on mower. Replace both belt covers.

## GENERAL CARE AND STORAGE

Top of mower deck should be washed with a garden hose after each use. A mild automotive detergent may be used to remove stubborn dirt. After washing, allow mower to dry, then start tractor and engage mower for approximately one minute to remove excess water from belts and pulleys.

Touch-up painted surfaces with a fresh coat of "Toro Wheel Horse Red", available from your authorized Toro Wheel Horse dealer in aerosol cans.

Store mower in a clean, dry place or protect it with a weather-proof cover when stored outdoors.



Consumer Products

# THE TORO TOTAL COVERAGE GUARANTEE A Full Warranty (Limited Warranty for Commercial Use)

## What Is Covered By This Express Warranty?

The Toro Company promises to repair any TORO Product used for residential purposes if defective in materials or workmanship for the following time periods from the date of purchase:

- Super Pro® Walk Mowers . . . . . 5 year full warranty
- All Others . . . . . 2 year full warranty

The cost of parts and labor are included, but the customer pays the transportation costs.

Transportation within a 15 mile radius of the servicing dealer is covered under this warranty for two-stage snowthrowers, walk behind debris equipment and all TORO Wheel Horse riding products. Walk power mowers, single stage snowthrowers, and other products not specifically covered, are excluded from the transportation coverage provided by this warranty.

## What Products Are Covered By This Warranty?

This warranty applies to all gasoline powered Consumer Products (including TORO Wheel Horse riding products). ProLine riding products and wide area walk behind mowers are covered by separate warranty statements.

## How About Commercial Use?

TORO Consumer Products used for commercial, institutional or rental use are covered by a limited warranty for the following time periods from the date of purchase:

Products	Warranty Period
• Garden Tractors	
Chassis . . . . .	1 year limited warranty
Engine . . . . .	2 year limited warranty
• 21" Commercial Duty Walk Mowers . . . . .	1 year limited warranty
• Lawn Tractors, Yard Tractors, Rear Engine Riders, Straight Shaft Trimmers, and Backpack Blowers . . . . .	90 day limited warranty
• All Others . . . . .	45 day limited warranty

## How Do You Get Warranty Service?

Should you feel your TORO product contains a defect in material or workmanship, contact the dealer who sold you the product or any Authorized TORO Service Dealer or TORO Master Service Dealer. The Yellow Pages of your telephone directory is a good reference source. The dealer will either arrange service at his/her dealership or recommend another Authorized Service Dealer who may be more convenient. You may need proof of purchase (copy of registration card, sales receipt, etc.) for warranty validation.

If for any reason you are dissatisfied with the Service Dealer's analysis of the defect in materials or workmanship or if you need a referral to a TORO Service Dealer, please feel free to contact us at the following address:

Toro Customer Service Department  
8111 Lyndale Avenue South  
Bloomington, MN 55420-1196  
612-888-8801  
1-800-348-2424

## What Must You Do To Keep The Warranty In Effect?

You must maintain your TORO Product by following the maintenance procedures described in the operator's manual. Such routine maintenance, whether performed by a dealer or by you, is at your expense.

## What Does This Warranty Not Cover? and How Does Your State Law Relate To This Warranty?

There is no other express warranty except the TORO Starting Guarantee on GTS Engines. This express warranty does not cover:

- Cost of regular maintenance service or parts, such as filters, fuel, lubricants, tune-up parts, blade sharpening, brake and clutch adjustments.
- Any product or part which has been altered or misused or required replacement or repair due to normal wear, accidents, or lack of proper maintenance.
- Repairs necessary due to improper fuel, contaminants in the fuel system, or failure to properly prepare the fuel system prior to any period of non-use over three months.
- Pickup and delivery charges for distances beyond a 15 mile radius from an Authorized TORO Service Dealer (covered products only).

All repairs covered by this warranty must be performed by an Authorized TORO Service Dealer using Toro approved replacement parts.

Repair by an Authorized TORO Service Dealer is your sole remedy under this warranty.

**The Toro Company is not liable for indirect, incidental or consequential damages in connection with the use of the TORO Products covered by this warranty, including any cost or expense of providing substitute equipment or service during reasonable periods of malfunction or non-use pending completion of repairs under this warranty. Some states do not allow exclusions of incidental or consequential damages, so the above exclusion may not apply to you.**

**This warranty gives you specific legal rights, and you may also have other rights which vary from state to state.**

## COUNTRIES OTHER THAN THE UNITED STATES OR CANADA

Customers who have purchased TORO products exported from the United States or Canada should contact their TORO Distributor (Dealer) to obtain guarantee policies for your country, province, or state. If for any reason you are dissatisfied with your Distributor's service or have difficulty obtaining guarantee information, contact the TORO importer. If all other remedies fail, you may contact us at The Toro Company.